

Guard Lock Safety-Door Switch

- Vertically mounting guard lock safety-door switch ideal for limited installation space
- Selectable operation key insertion direction
- Slim safety-door switch with an electromagnetic lock or unlock mechanism
- Built-in switches with multiple-contact construction are available
- A key holding force of 1,000 N minimum
- Can be used for either standard loads or microloads
- Lineup includes models with a conduit size of M20
- Variety of metallic heads available



G

Specifications

Standards and EC Directives

Conforms to the following EC Directives:

- Machinery Directive
- Low Voltage Directive
- EN 1088
- EN 60204-1
- GS-ET-19

Certified Standards

Certification body	Standard	File No.
TÜV SÜD	EN 60947-5-1 (certified direct opening)	Consult your representative for details.
UL *1	UL 508, CSA C22.2 No.14	E76675
CQC (CCC)	GB14048.5	2003010305064264
KOSHA *2	EN60947-5-1	2007-26

*1. Certification for CSA C22.2 No. 14 is authorized by the UL mark.

*2. Only certain models have been certified.

Certified Standard Ratings

TÜV (EN 60947-5-1), CCC (GB14048.5)

Item	Utilization category	AC-15	DC-13
Rated operating current (Ie)		0.75 A	0.27 A
Rated operating voltage (Ue)		240 V	250 V

Note: Use a 10 A fuse type gl or gG that conforms to IEC 60269 as a short-circuit protection device.

UL/CSA (UL 508, CSA C22.2 No. 14) C300

Rated voltage	Carry current	Current (A)		Volt-amperes (VA)	
		Make	Break	Make	Break
120 VAC	2.5 A	15	1.5	1,800	180
240 VAC		7.5	0.75		

Q300

Rated voltage	Carry current	Current (A)		Volt-amperes (VA)	
		Make	Break	Make	Break
125 VDC	2.5 A	0.55	0.55	69	69
250 VDC		0.27	0.27		

Solenoid Coil Characteristics

Item	Type	24 VDC
Rated operating voltage (100% ED)		24 VDC ±10%
Current consumption		Approx. 200 mA
Insulation Class		Class F (130°C max.)

Indicator Characteristics

Item	Type	LED
Rated voltage		24 VDC
Current consumption		Approx. 3 mA
Color (LED)		Orange/Green

Connections

Contact Form

Indicates conditions where the Key is inserted and the lock is applied. Terminals 12 and 41 are connected internally (as per BIA GS-ET-19).

Model	Contact (door open/closed detection and lock monitor)	Contact form		Operating pattern	Remarks
		Door open/closed detection	Lock monitor		
D4GL-□AF□-□	1NC/1NO + 1NC/1NO			<p>Only NC contact 11-12 has a certified direct opening mechanism. (⊖)</p> <p>The terminals 11-42, 33-34, and 53-54 can be used as unlike poles.</p>	
D4GL-□BF□-□	1NC/1NO + 2NC			<p>Only NC contact 11-12, has a certified direct opening mechanism. (⊖)</p> <p>The terminals 11-42, 33-34, and 51-52 can be used as unlike poles.</p>	
D4GL-□CF□-□	2NC + 1NC/1NO			<p>Only NC contacts 11-12 and 21-22 have a certified direct opening mechanism. (⊖)</p> <p>The terminals 11-42, 21-22, and 53-54 can be used as unlike poles.</p>	
D4GL-□DF□-□	2NC + 2NC			<p>Only NC contacts 11-12 and 21-22 have a certified direct opening mechanism. (⊖)</p> <p>The terminals 11-42, 21-22, and 51-52 can be used as unlike poles.</p>	
D4GL-□EF□-□	2NC/1NO + 1NC/1NO			<p>Only NC contacts 11-12 and 21-22 have a certified direct opening mechanism. (⊖)</p> <p>The terminals 11-42, 21-22, 33-34, and 53-54 can be used as unlike poles.</p>	
D4GL-□FF□-□	2NC/1NO + 2NC			<p>Only NC contacts 11-12 and 21-22 have a certified direct opening mechanism. (⊖)</p> <p>The terminals 11-42, 21-22, 33-34, and 51-52 can be used as unlike poles.</p>	
D4GL-□GF□-□	3NC + 1NC/1NO			<p>Only NC contacts 11-12, 21-22, and 31-32 have a certified direct opening mechanism. (⊖)</p> <p>The terminals 11-42, 21-22, 31-32, and 53-54 can be used as unlike poles.</p>	
D4GL-□HF□-□	3NC + 2NC			<p>Only NC contacts 11-12, 21-22, and 31-32 have a certified direct opening mechanism. (⊖)</p> <p>The terminals 11-42, 21-22, 31-32, and 51-52 can be used as unlike poles.</p>	



Dimensions and Operating Characteristics

(mm)

Switches

D4GL-□□□□-A

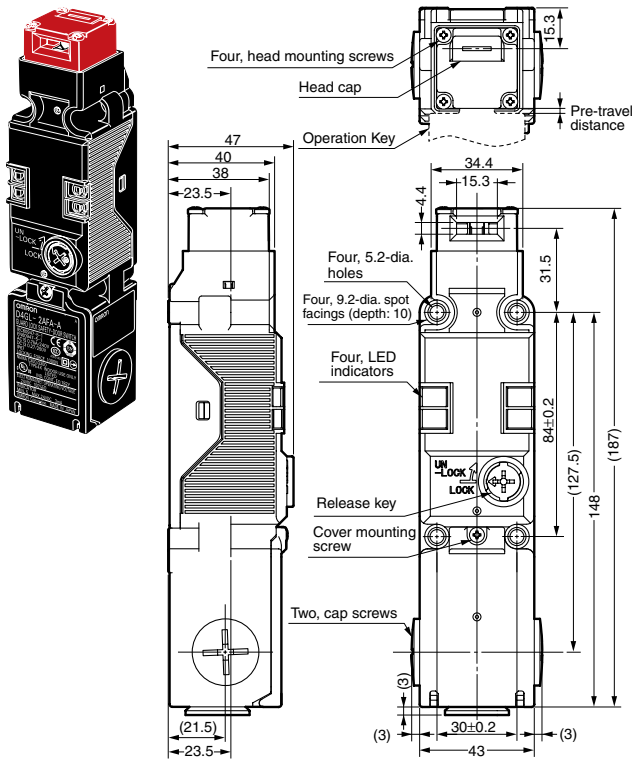

D4GL-□□□□-A4

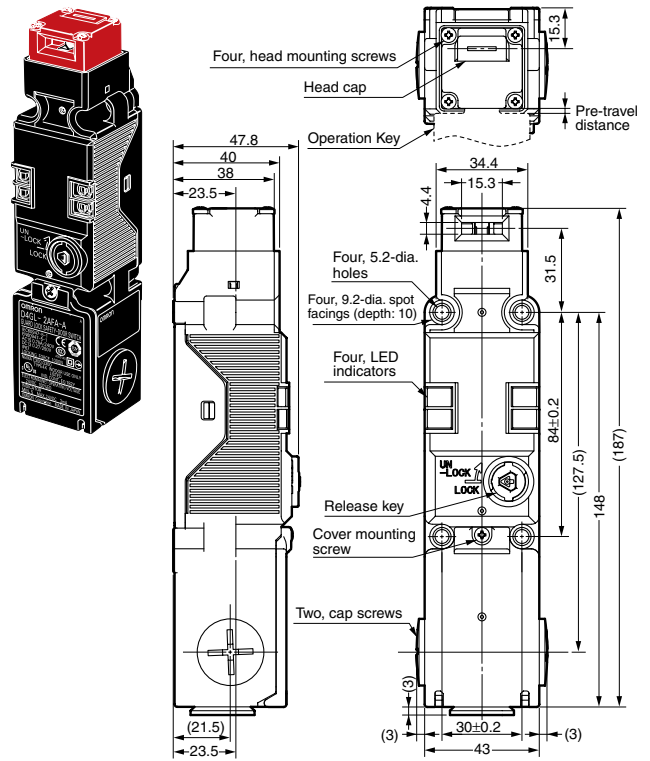

Operating characteristics	D4GL-□□□□-A
Key insertion force	15 N max.
Key extraction force	40 N max.
Pre-travel distance	10 mm max.
Movement before being locked	4 mm min.

Operating characteristics	D4GL-□□□□-A4
Key insertion force	15 N max.
Key extraction force	40 N max.
Pre-travel distance	10 mm max.
Movement before being locked	4 mm min.

Operation Keys

D4DS-K1

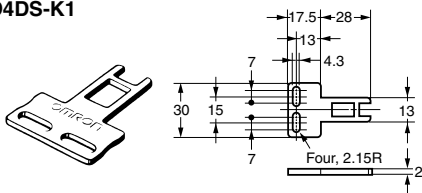

D4DS-K3

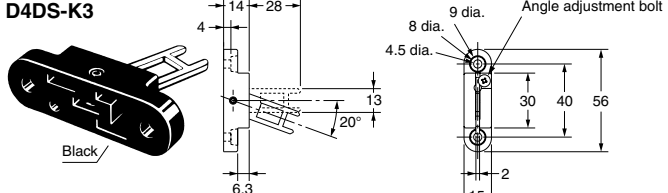

D4DS-K2

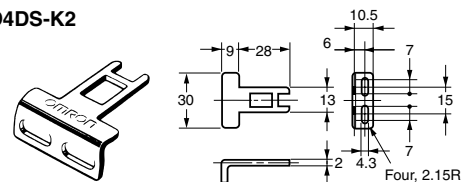

D4DS-K5

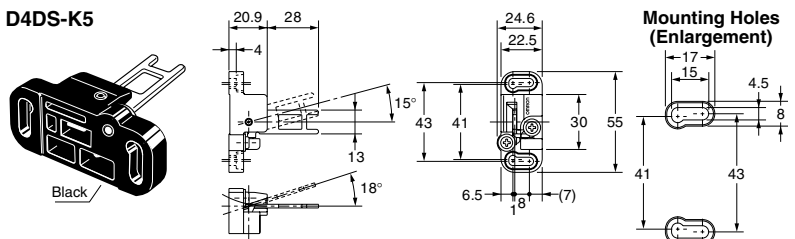

Note: Unless otherwise specified, a tolerance of ±0.4 mm applies to all dimensions.

Dimensions and Operating Characteristics (continued)

(mm)

With Operation Key Inserted

D4GL + D4DS-K1
(with Front-inserted Operation Key)

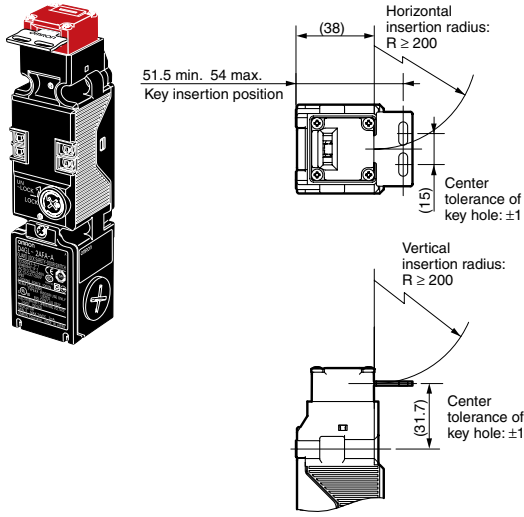

D4GL + D4DS-K1
(with Top-inserted Operation Key)

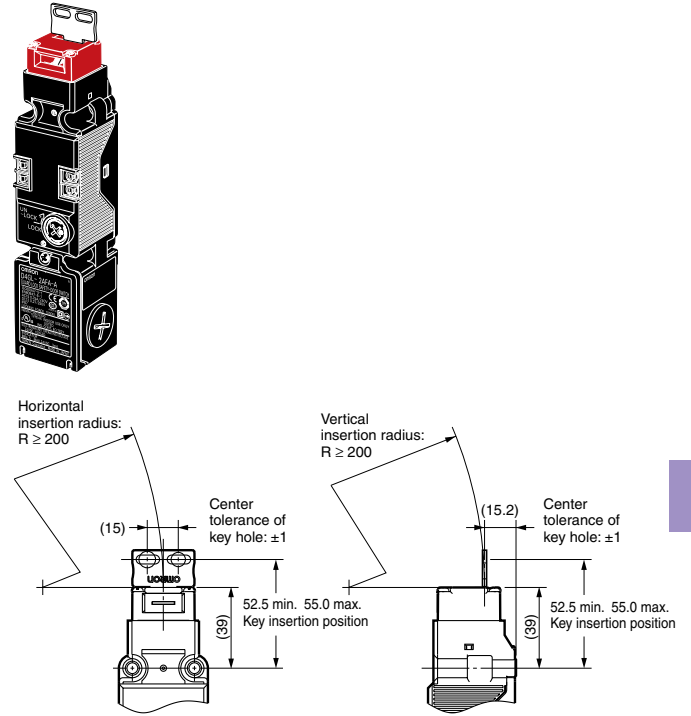

D4GL + D4DS-K2
(with Front-inserted Operation Key)

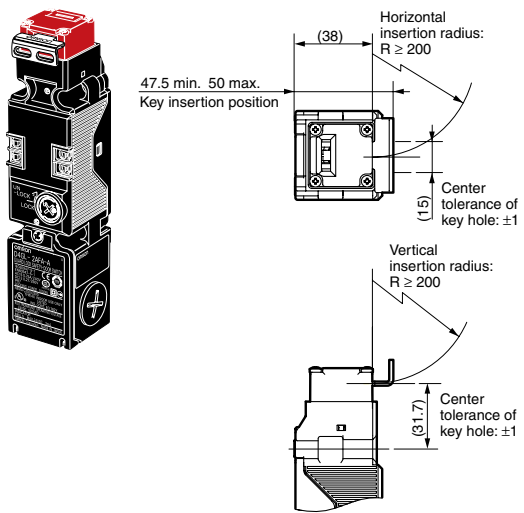

D4GL + D4DS-K2

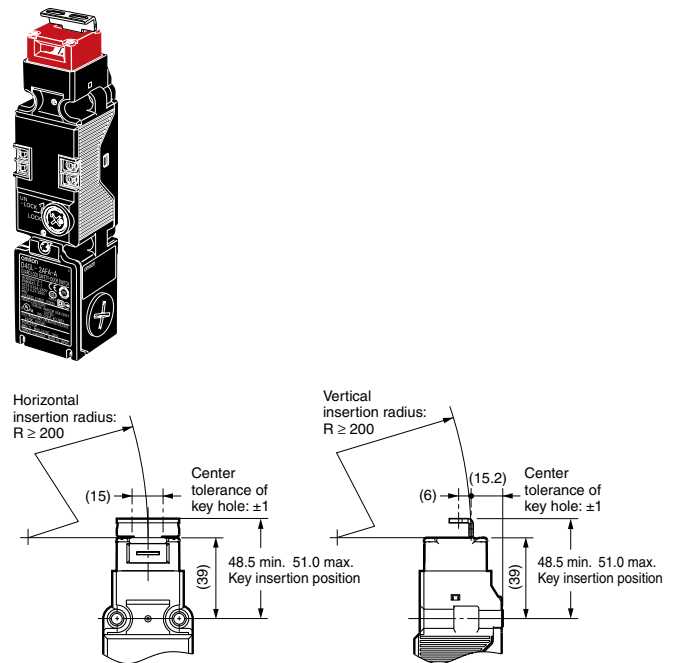

Dimensions and Operating Characteristics (continued)

(mm)

With Operation Key Inserted

D4GL + D4DS-K3
(with Front-inserted Operation Key)

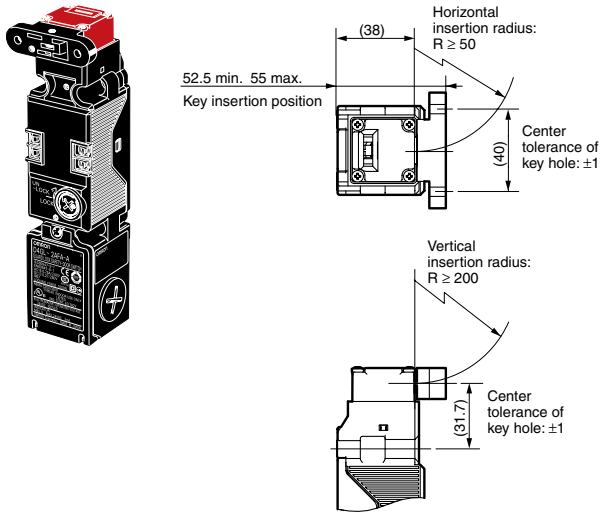

D4GL + D4DS-K3
(with Top-inserted Operation Key)

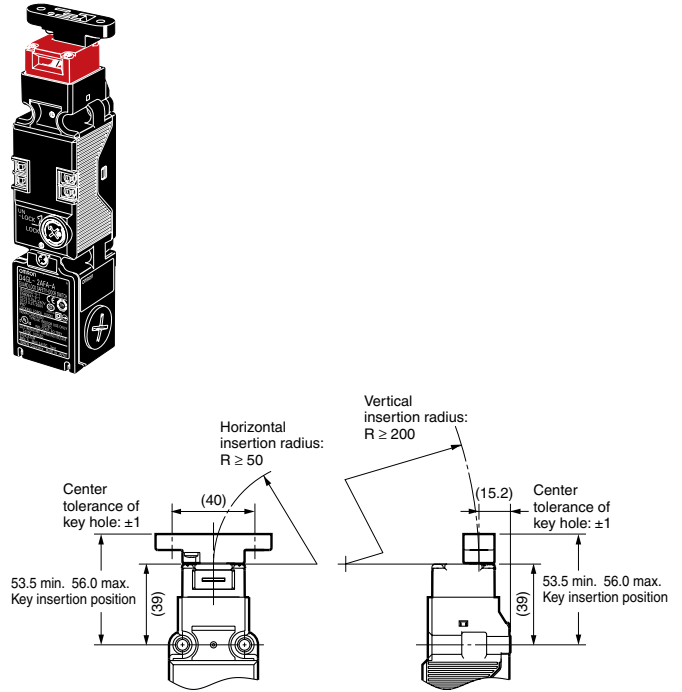

D4GL + D4DS-K5
(with Front-inserted Operation Key)

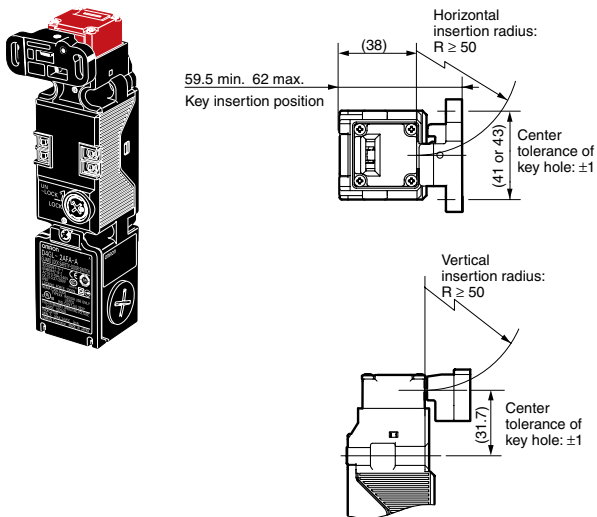

D4GL + D4DS-K5
(with Top-inserted Operation Key)

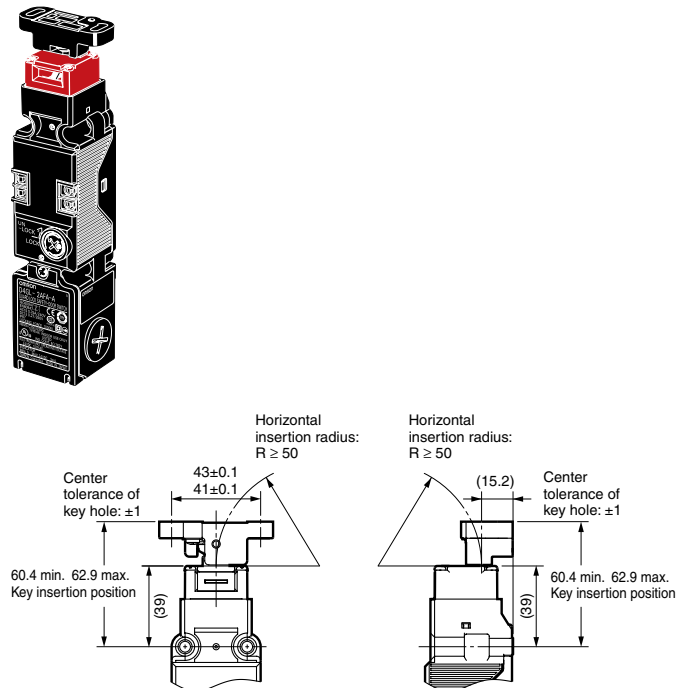

G

Application Examples

G9SA-321-T + D4GL-□AFA-□ (Mechanical Lock Type) Circuit Diagram (Manual Reset)

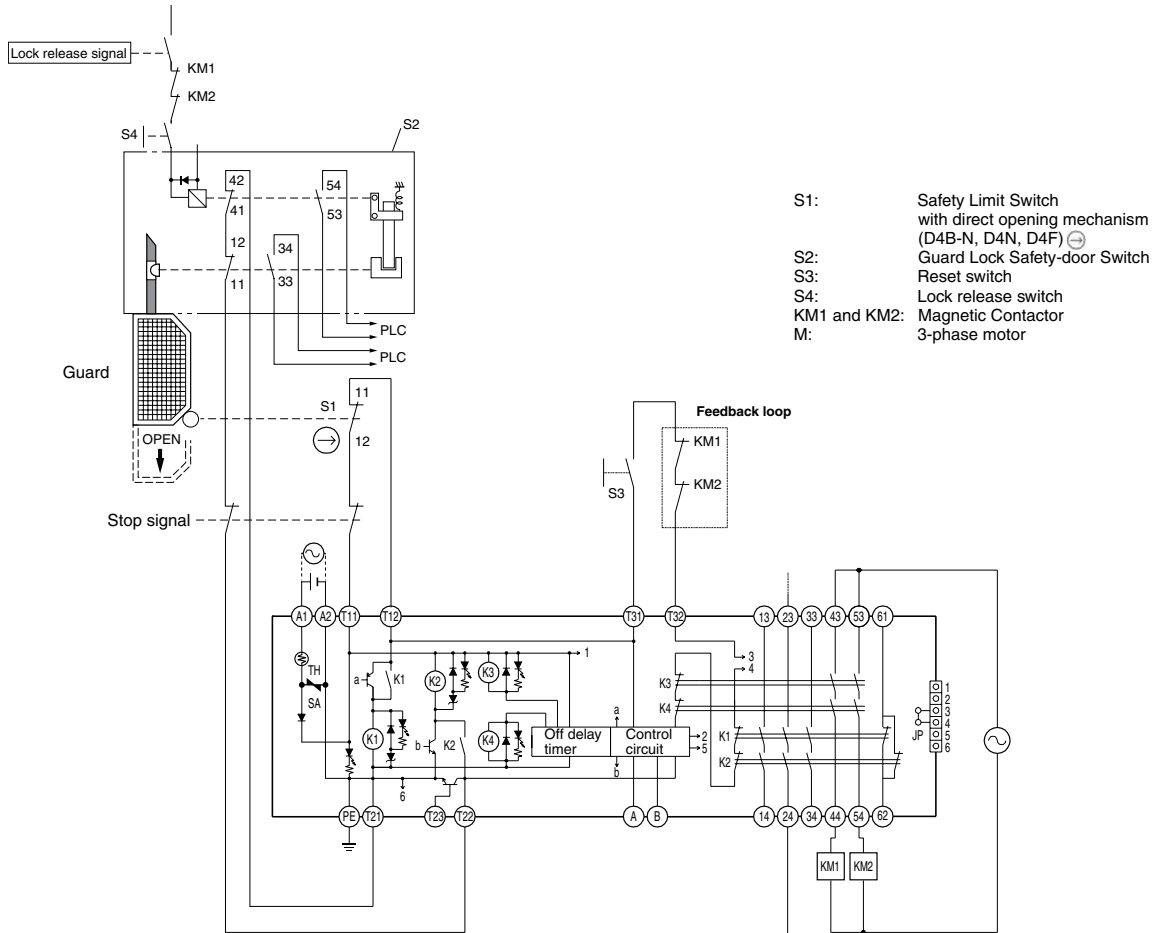

- S1: Safety Limit Switch with direct opening mechanism (D4B-N, D4N, D4F)
- S2: Guard Lock Safety-door Switch
- S3: Reset switch
- S4: Lock release switch
- KM1 and KM2: Magnetic Contactor
- M: 3-phase motor

Timing Chart

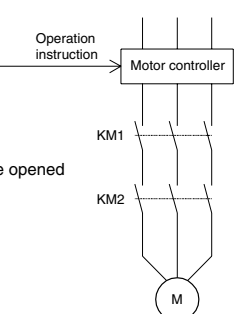
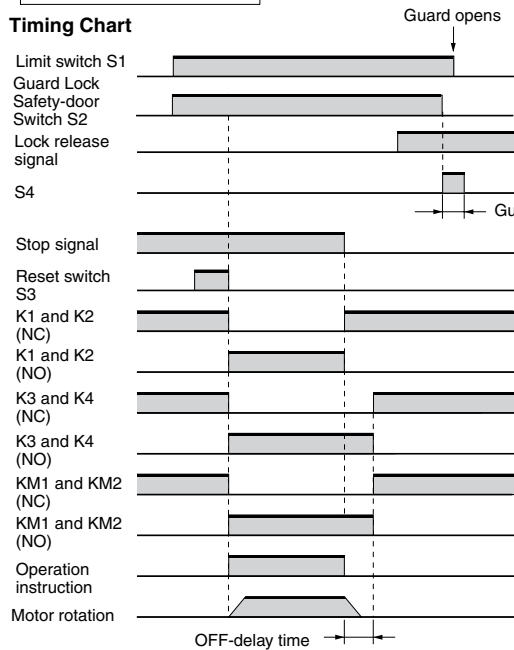

Note: The above example circuit is for Category 3.

Ordering

Model Number Structure

Switch

D4GL - □ □ □ □ - □ □
 ① ② ③ ④ ⑤ ⑥





- ① Conduit Size
 - 1: Pg13.5
 - 2: G1/2
 - 4: M20
- ② Built-in Switch (with Door Open/Closed Detection Switch and Lock Monitor Switch Contacts)
 - A: 1NC/1NO (slow-action contacts) + 1NC/1NO (slow-action contacts)
 - B: 1NC/1NO (slow-action contacts) + 2NC (slow-action contacts)
 - C: 2NC (slow-action contacts) + 1NC/1NO (slow-action contacts)
 - D: 2NC (slow-action contacts) + 2NC (slow-action contacts)
 - E: 2NC/1NO (slow-action contacts) + 1NC/1NO (slow-action contacts)
 - F: 2NC/1NO (slow-action contacts) + 2NC (slow-action contacts)
 - G: 3NC (slow-action contacts) + 1NC/1NO (slow-action contacts)
 - H: 3NC (slow-action contacts) + 2NC (slow-action contacts)
- ③ Head Mounting Direction and Material
 - F: Four mounting directions possible (Front-side mounting at shipping)/plastic
 - D: Four mounting directions possible (Front-side mounting at shipping)/metal
- ④ Door Lock and Release
 - A: Mechanical lock/24 VDC solenoid release
 - G: 24 VDC solenoid lock/mechanical release
- ⑤ Indicator
 - A: 24 VDC (orange/green LED indicator)
- ⑥ Release Key Type
 - Blank: Standard release key
 - 4: Special Release Key
- ⑦ NPT, 1/2"-14 NPT Conduit
 - Adapter included
 - (Applicable to M20 Conduit models only)
 - Note: To specify 1/2" NPT adapter, add "-NPT" to end of model code.

G

Operation Key

D4DS-K □
 ①

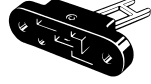
- ① Operation Key Type
 - 1: Horizontal mounting
 - 2: Vertical mounting
 - 3: Adjustable mounting (horizontal)
 - 5: Adjustable mounting (horizontal/vertical)

Type	Model
Horizontal mounting 	D4DS-K1
Vertical mounting 	D4DS-K2
Adjustable mounting (horizontal) 	D4DS-K3
Adjustable mounting (horizontal/vertical) 	D4DS-K5

 = Highlighted **Rapid Delivery** products are available for shipment today or within **FIVE** days.

 For information on the D4GL-SK10-LK Slide Key, see page G215.

Ordering (continued)

List of Models

Switches with certified direct opening mechanisms (Operation Keys are sold separately)

Head Material	Release Key Type	Solenoid Voltage/Indicator	Lock and Release Types	Contact Configuration (door open/closed detection switch and lock monitor switch contacts) (slow action) Certified direct opening NC contact	Conduit size	Model
Plastic	Standard	Solenoid: 24 VDC Orange/Green LED: 24 VDC	Mechanical lock Solenoid Release	1NC/1NO+1NC/1NO	M20	D4GL-4AFA-A
					M20 with 1/2" NPT adaptor	D4GL-4AFA-A-NPT
				1NC/1NO+2NC	M20	D4GL-4BFA-A
					M20 with 1/2" NPT adaptor	D4GL-4BFA-A-NPT
				2NC+1NC/1NO	M20	D4GL-4CFA-A
					M20 with 1/2" NPT adaptor	D4GL-4CFA-A-NPT
				2NC+2NO	M20	D4GL-4DFA-A
					M20 with 1/2" NPT adaptor	D4GL-4DFA-A-NPT
				2NC/1NO+1NC/1NO	M20	D4GL-4EFA-A
					M20 with 1/2" NPT adaptor	D4GL-4EFA-A-NPT
				2NC/1NO+2NC	M20	D4GL-4FFA-A
					M20 with 1/2" NPT adaptor	D4GL-4FFA-A-NPT
				3NC+1NC/1NO	M20	D4GL-4GFA-A
					M20 with 1/2" NPT adaptor	D4GL-4GFA-A-NPT
			3NC+2NC	M20	D4GL-4HFA-A	
				M20 with 1/2" NPT adaptor	D4GL-4HFA-A-NPT	
			Solenoid lock Mechanical Release	1NC/1NO+1NC/1NO	M20	D4GL-4AFG-A
					M20 with 1/2" NPT adaptor	D4GL-4AFG-A-NPT
				1NC/1NO+2NC	M20	D4GL-4BFG-A
					M20 with 1/2" NPT adaptor	D4GL-4BFG-A-NPT
				2NC+1NC/1NO	M20	D4GL-4CFG-A
					M20 with 1/2" NPT adaptor	D4GL-4CFG-A-NPT
				2NC+2NO	M20	D4GL-4DFG-A
					M20 with 1/2" NPT adaptor	D4GL-4DFG-A-NPT
				2NC/1NO+1NC/1NO	M20	D4GL-4EFG-A
					M20 with 1/2" NPT adaptor	D4GL-4EFG-A-NPT
				2NC/1NO+2NC	M20	D4GL-4FFG-A
					M20 with 1/2" NPT adaptor	D4GL-4FFG-A-NPT
3NC+1NC/1NO	M20	D4GL-4GFG-A				
	M20 with 1/2" NPT adaptor	D4GL-4GFG-A-NPT				
3NC+2NC	M20	D4GL-4HFG-A				
	M20 with 1/2" NPT adaptor	D4GL-4HFG-A-NPT				

G

 = Highlighted **Rapid Delivery** products are available for shipment today or within **FIVE** days.

(Continued on next page)

Ordering (continued)

List of Models (continued)

Switches with certified direct opening mechanisms (Operation Keys are sold separately) (continued)

Head Material	Release Key Type	Solenoid Voltage/Indicator	Lock and Release Types	Contact Configuration (door open/closed detection switch and lock monitor switch contacts) (slow action) Certified direct opening NC contact	Conduit size	Model
Plastic	Special Release Key	Solenoid: 24 VDC Orange/Green LED: 24 VDC	Mechanical lock Solenoid Release	1NC/1NO+1NC/1NO	M20	D4GL-4AFA-A4
					M20 with 1/2" NPT adaptor	D4GL-4AFA-A4-NPT
				1NC/1NO+2NC	M20	D4GL-4BFA-A4
					M20 with 1/2" NPT adaptor	D4GL-4BFA-A4-NPT
				2NC+1NC/1NO	M20	D4GL-4CFA-A4
					M20 with 1/2" NPT adaptor	D4GL-4CFA-A4-NPT
				2NC+2NO	M20	D4GL-4DFA-A4
					M20 with 1/2" NPT adaptor	D4GL-4DFA-A4-NPT
				2NC/1NO+1NC/1NO	M20	D4GL-4EFA-A4
					M20 with 1/2" NPT adaptor	D4GL-4EFA-A4-NPT
				2NC/1NO+2NC	M20	D4GL-4FFA-A4
					M20 with 1/2" NPT adaptor	D4GL-4FFA-A4-NPT
				3NC+1NC/1NO	M20	D4GL-4GFA-A4
					M20 with 1/2" NPT adaptor	D4GL-4GFA-A4-NPT
			3NC+2NC	M20	D4GL-4HFA-A4	
				M20 with 1/2" NPT adaptor	D4GL-4HFA-A4-NPT	
			Solenoid lock Mechanical Release	1NC/1NO+1NC/1NO	M20	D4GL-4AFG-A4
					M20 with 1/2" NPT adaptor	D4GL-4AFG-A4-NPT
				1NC/1NO+2NC	M20	D4GL-4BFG-A4
					M20 with 1/2" NPT adaptor	D4GL-4BFG-A4-NPT
				2NC+1NC/1NO	M20	D4GL-4CFG-A4
					M20 with 1/2" NPT adaptor	D4GL-4CFG-A4-NPT
				2NC+2NO	M20	D4GL-4DFG-A4
					M20 with 1/2" NPT adaptor	D4GL-4DFG-A4-NPT
				2NC/1NO+1NC/1NO	M20	D4GL-4EFG-A4
					M20 with 1/2" NPT adaptor	D4GL-4EFG-A4-NPT
				2NC/1NO+2NC	M20	D4GL-4FFG-A4
					M20 with 1/2" NPT adaptor	D4GL-4FFG-A4-NPT
3NC+1NC/1NO	M20	D4GL-4GFG-A4				
	M20 with 1/2" NPT adaptor	D4GL-4GFG-A4-NPT				
3NC+2NC	M20	D4GL-4HFG-A4				
	M20 with 1/2" NPT adaptor	D4GL-4HFG-A4-NPT				
Metal	Special Release Key	24 VDC	Mechanical lock Solenoid Release	2NC/1NO + 1NC/NO	M20 with 1/2" NPT adaptor	D4GL-4EDA-A4-NPT
			Solenoid lock Mechanical Release	3NC+1NC/1NO		D4GL-4GDG-A4-NPT
			Solenoid lock Mechanical Release	2NC/1NO + 1NC/NO		D4GL-4EDG-A4-NPT

 = Highlighted **Rapid Delivery** products are available for shipment today or within **FIVE** days.



Компания «ЭлектроПласт» предлагает заключение долгосрочных отношений при поставках импортных электронных компонентов на взаимовыгодных условиях!

Наши преимущества:

- Оперативные поставки широкого спектра электронных компонентов отечественного и импортного производства напрямую от производителей и с крупнейших мировых складов;
- Поставка более 17-ти миллионов наименований электронных компонентов;
- Поставка сложных, дефицитных, либо снятых с производства позиций;
- Оперативные сроки поставки под заказ (от 5 рабочих дней);
- Экспресс доставка в любую точку России;
- Техническая поддержка проекта, помощь в подборе аналогов, поставка прототипов;
- Система менеджмента качества сертифицирована по Международному стандарту ISO 9001;
- Лицензия ФСБ на осуществление работ с использованием сведений, составляющих государственную тайну;
- Поставка специализированных компонентов (Xilinx, Altera, Analog Devices, Intersil, Interpoint, Microsemi, Aeroflex, Peregrine, Syfer, Eurofarad, Texas Instrument, Miteq, Cobham, E2V, MA-COM, Hittite, Mini-Circuits, General Dynamics и др.);

Помимо этого, одним из направлений компании «ЭлектроПласт» является направление «Источники питания». Мы предлагаем Вам помощь Конструкторского отдела:

- Подбор оптимального решения, техническое обоснование при выборе компонента;
- Подбор аналогов;
- Консультации по применению компонента;
- Поставка образцов и прототипов;
- Техническая поддержка проекта;
- Защита от снятия компонента с производства.



Как с нами связаться

Телефон: 8 (812) 309 58 32 (многоканальный)

Факс: 8 (812) 320-02-42

Электронная почта: org@eplast1.ru

Адрес: 198099, г. Санкт-Петербург, ул. Калинина, дом 2, корпус 4, литера А.