



Is Now Part of



ON Semiconductor®

To learn more about ON Semiconductor, please visit our website at
www.onsemi.com

Please note: As part of the Fairchild Semiconductor integration, some of the Fairchild orderable part numbers will need to change in order to meet ON Semiconductor's system requirements. Since the ON Semiconductor product management systems do not have the ability to manage part nomenclature that utilizes an underscore (_), the underscore (_) in the Fairchild part numbers will be changed to a dash (-). This document may contain device numbers with an underscore (_). Please check the ON Semiconductor website to verify the updated device numbers. The most current and up-to-date ordering information can be found at www.onsemi.com. Please email any questions regarding the system integration to Fairchild_questions@onsemi.com.

ON Semiconductor and the ON Semiconductor logo are trademarks of Semiconductor Components Industries, LLC dba ON Semiconductor or its subsidiaries in the United States and/or other countries. ON Semiconductor owns the rights to a number of patents, trademarks, copyrights, trade secrets, and other intellectual property. A listing of ON Semiconductor's product/patent coverage may be accessed at www.onsemi.com/site/pdf/Patent-Marking.pdf. ON Semiconductor reserves the right to make changes without further notice to any products herein. ON Semiconductor makes no warranty, representation or guarantee regarding the suitability of its products for any particular purpose, nor does ON Semiconductor assume any liability arising out of the application or use of any product or circuit, and specifically disclaims any and all liability, including without limitation special, consequential or incidental damages. Buyer is responsible for its products and applications using ON Semiconductor products, including compliance with all laws, regulations and safety requirements or standards, regardless of any support or applications information provided by ON Semiconductor. "Typical" parameters which may be provided in ON Semiconductor data sheets and/or specifications can and do vary in different applications and actual performance may vary over time. All operating parameters, including "Typicals" must be validated for each customer application by customer's technical experts. ON Semiconductor does not convey any license under its patent rights nor the rights of others. ON Semiconductor products are not designed, intended, or authorized for use as a critical component in life support systems or any FDA Class 3 medical devices or medical devices with a same or similar classification in a foreign jurisdiction or any devices intended for implantation in the human body. Should Buyer purchase or use ON Semiconductor products for any such unintended or unauthorized application, Buyer shall indemnify and hold ON Semiconductor and its officers, employees, subsidiaries, affiliates, and distributors harmless against all claims, costs, damages, and expenses, and reasonable attorney fees arising out of, directly or indirectly, any claim of personal injury or death associated with such unintended or unauthorized use, even if such claim alleges that ON Semiconductor was negligent regarding the design or manufacture of the part. ON Semiconductor is an Equal Opportunity/Affirmative Action Employer. This literature is subject to all applicable copyright laws and is not for resale in any manner.



October 2014

FDMS7580

N-Channel Power Trench[®] MOSFET

25 V, 7.5 mΩ

Features

- Max $r_{DS(on)}$ = 7.5 mΩ at $V_{GS} = 10\text{ V}$, $I_D = 15\text{ A}$
- Max $r_{DS(on)}$ = 11.1 mΩ at $V_{GS} = 4.5\text{ V}$, $I_D = 12\text{ A}$
- Advanced Package and Silicon combination for low $r_{DS(on)}$ and high efficiency
- Next generation enhanced body diode technology, engineered for soft recovery
- MSL1 robust package design
- 100% UIL tested
- RoHS Compliant



General Description

This N-Channel MOSFET has been designed specifically to improve the overall efficiency and to minimize switch node ringing of DC/DC converters using either synchronous or conventional switching PWM controllers. It has been optimized for low gate charge, low $r_{DS(on)}$, fast switching speed and body diode reverse recovery performance.

Applications

- Control MOSFET for Synchronous Buck Converters
- Notebook
- Server
- Telecomm
- High Efficiency DC-DC Switch Mode Power Supplies

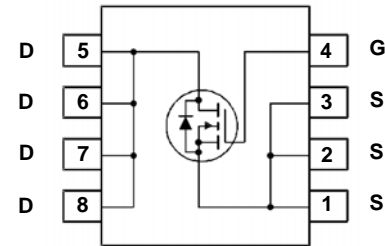
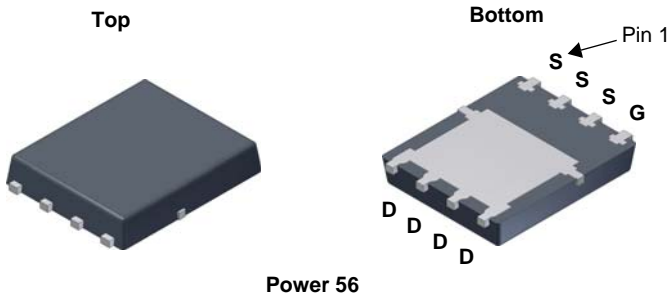

MOSFET Maximum Ratings $T_A = 25\text{ °C}$ unless otherwise noted

Symbol	Parameter	Ratings	Units
V_{DS}	Drain to Source Voltage	25	V
V_{GS}	Gate to Source Voltage (Note 4)	± 20	V
I_D	Drain Current -Continuous (Package limited) $T_C = 25\text{ °C}$	28	A
	-Continuous (Silicon limited) $T_C = 25\text{ °C}$	49	
	-Continuous $T_A = 25\text{ °C}$ (Note 1a)	15	
	-Pulsed	60	
E_{AS}	Single Pulse Avalanche Energy (Note 3)	32	mJ
P_D	Power Dissipation $T_C = 25\text{ °C}$	27	W
	Power Dissipation $T_A = 25\text{ °C}$ (Note 1a)	2.5	
T_J, T_{STG}	Operating and Storage Junction Temperature Range	-55 to +150	$^{\circ}\text{C}$

Thermal Characteristics

$R_{\theta JC}$	Thermal Resistance, Junction to Case	4.6	$^{\circ}\text{C/W}$
$R_{\theta JA}$	Thermal Resistance, Junction to Ambient (Note 1a)	50	

Package Marking and Ordering Information

Device Marking	Device	Package	Reel Size	Tape Width	Quantity
FDMS7580	FDMS7580	Power 56	13 "	12 mm	3000 units

FDMS7580 N-Channel Power Trench[®] MOSFET

Electrical Characteristics $T_J = 25\text{ }^\circ\text{C}$ unless otherwise noted

Symbol	Parameter	Test Conditions	Min	Typ	Max	Units
--------	-----------	-----------------	-----	-----	-----	-------

Off Characteristics

BV_{DSS}	Drain to Source Breakdown Voltage	$I_D = 250\text{ }\mu\text{A}$, $V_{GS} = 0\text{ V}$	25			V
$\frac{\Delta BV_{DSS}}{\Delta T_J}$	Breakdown Voltage Temperature Coefficient	$I_D = 250\text{ }\mu\text{A}$, referenced to $25\text{ }^\circ\text{C}$		18		mV/ $^\circ\text{C}$
I_{DSS}	Zero Gate Voltage Drain Current	$V_{DS} = 20\text{ V}$, $V_{GS} = 0\text{ V}$			1	μA
I_{GSS}	Gate to Source Leakage Current	$V_{GS} = 20\text{ V}$, $V_{DS} = 0\text{ V}$			100	nA

On Characteristics

$V_{GS(th)}$	Gate to Source Threshold Voltage	$V_{GS} = V_{DS}$, $I_D = 250\text{ }\mu\text{A}$	1.0	1.6	3.0	V
$\frac{\Delta V_{GS(th)}}{\Delta T_J}$	Gate to Source Threshold Voltage Temperature Coefficient	$I_D = 250\text{ }\mu\text{A}$, referenced to $25\text{ }^\circ\text{C}$		-6		mV/ $^\circ\text{C}$
$r_{DS(on)}$	Static Drain to Source On Resistance	$V_{GS} = 10\text{ V}$, $I_D = 15\text{ A}$		5.9	7.5	m Ω
		$V_{GS} = 4.5\text{ V}$, $I_D = 12\text{ A}$		8.3	11.1	
		$V_{GS} = 10\text{ V}$, $I_D = 15\text{ A}$, $T_J = 125\text{ }^\circ\text{C}$		8.3	10.6	
g_{FS}	Forward Transconductance	$V_{DD} = 5\text{ V}$, $I_D = 15\text{ A}$		63		S

Dynamic Characteristics

C_{iss}	Input Capacitance	$V_{DS} = 13\text{ V}$, $V_{GS} = 0\text{ V}$, $f = 1\text{ MHz}$		894	1190	pF
C_{oss}	Output Capacitance			277	370	pF
C_{rss}	Reverse Transfer Capacitance			53	80	pF
R_g	Gate Resistance			1.1	2.2	Ω

Switching Characteristics

$t_{d(on)}$	Turn-On Delay Time	$V_{DD} = 13\text{ V}$, $I_D = 15\text{ A}$, $V_{GS} = 10\text{ V}$, $R_{GEN} = 6\text{ }\Omega$		7.3	15	ns
t_r	Rise Time			2.4	10	ns
$t_{d(off)}$	Turn-Off Delay Time			17	31	ns
t_f	Fall Time			2.1	10	ns
$Q_{g(TOT)}$	Total Gate Charge	$V_{GS} = 0\text{ V to }10\text{ V}$	$V_{DD} = 13\text{ V}$ $I_D = 15\text{ A}$	14	20	nC
	Total Gate Charge	$V_{GS} = 0\text{ V to }4.5\text{ V}$		6.5	10	nC
Q_{gs}	Total Gate Charge			2.9		nC
Q_{gd}	Gate to Drain "Miller" Charge			1.6		nC

Drain-Source Diode Characteristics

V_{SD}	Source to Drain Diode Forward Voltage	$V_{GS} = 0\text{ V}$, $I_S = 2\text{ A}$ (Note 2)		0.73	1.1	V
		$V_{GS} = 0\text{ V}$, $I_S = 15\text{ A}$ (Note 2)		0.85	1.2	
t_{rr}	Reverse Recovery Time	$I_F = 15\text{ A}$, $di/dt = 100\text{ A}/\mu\text{s}$		19	34	ns
Q_{rr}	Reverse Recovery Charge			5.1	10	nC
t_{rr}	Reverse Recovery Time	$I_F = 15\text{ A}$, $di/dt = 300\text{ A}/\mu\text{s}$		15	27	ns
Q_{rr}	Reverse Recovery Charge			8.9	18	

NOTES:

- $R_{\theta JA}$ is determined with the device mounted on a 1 in^2 pad 2 oz copper pad on a $1.5 \times 1.5\text{ in.}$ board of FR-4 material. $R_{\theta JC}$ is guaranteed by design while $R_{\theta CA}$ is determined by the user's board design.

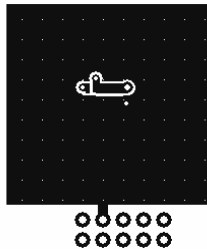

a. $50\text{ }^\circ\text{C/W}$ when mounted on a 1 in^2 pad of 2 oz copper

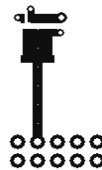

b. $125\text{ }^\circ\text{C/W}$ when mounted on a minimum pad of 2 oz copper

- Pulse Test: Pulse Width < $300\text{ }\mu\text{s}$, Duty cycle < 2.0 %.

- E_{AS} of 32 mJ is based on starting $T_J = 25\text{ }^\circ\text{C}$, $L = 1\text{ mH}$, $I_{AS} = 8\text{ A}$, $V_{DD} = 23\text{ V}$, $V_{GS} = 10\text{ V}$. 100% test at $L = 0.3\text{ mH}$, $I_{AS} = 12\text{ A}$.

- As an N-ch device, the negative Vgs rating is for low duty cycle pulse occurrence only. No continuous rating is implied.

Typical Characteristics $T_J = 25\text{ }^\circ\text{C}$ unless otherwise noted

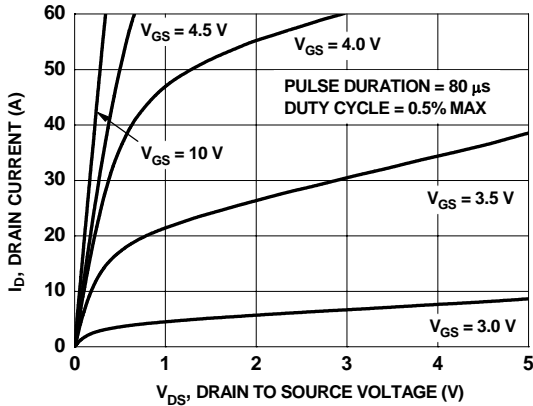

Figure 1. On-Region Characteristics

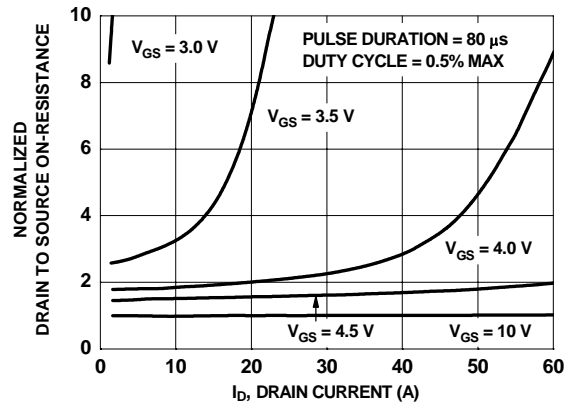

Figure 2. Normalized On-Resistance vs Drain Current and Gate Voltage

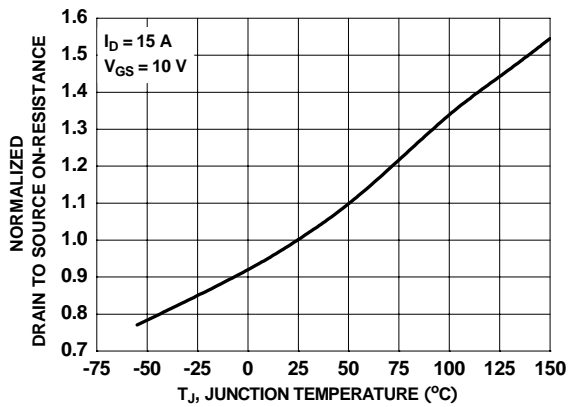

Figure 3. Normalized On-Resistance vs Junction Temperature

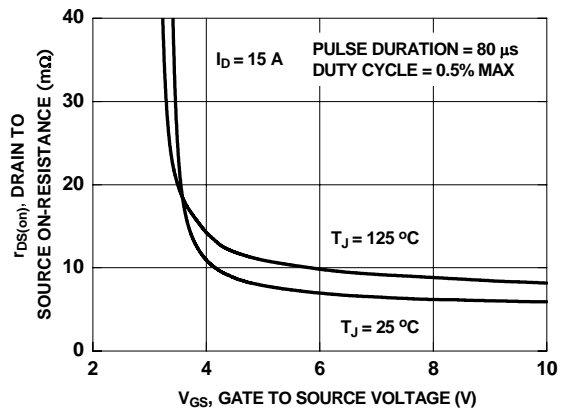

Figure 4. On-Resistance vs Gate to Source Voltage

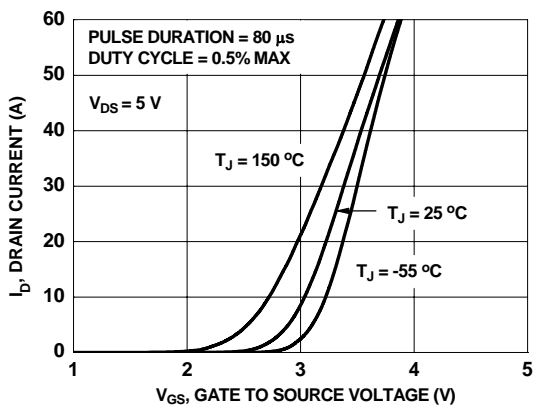

Figure 5. Transfer Characteristics

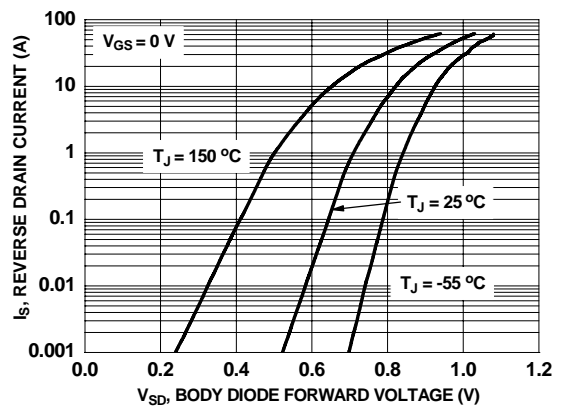

Figure 6. Source to Drain Diode Forward Voltage vs Source Current

Typical Characteristics $T_J = 25^\circ\text{C}$ unless otherwise noted

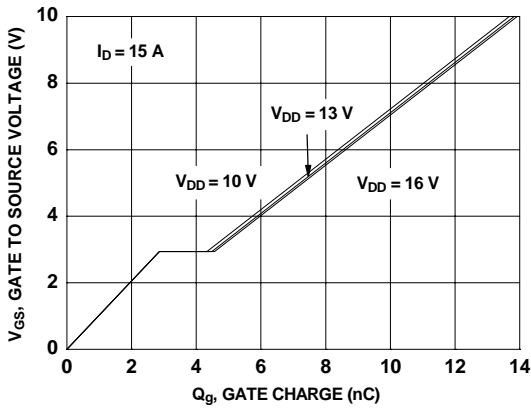

Figure 7. Gate Charge Characteristics

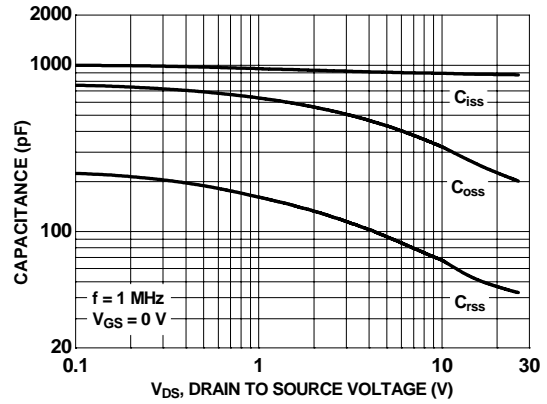

Figure 8. Capacitance vs Drain to Source Voltage

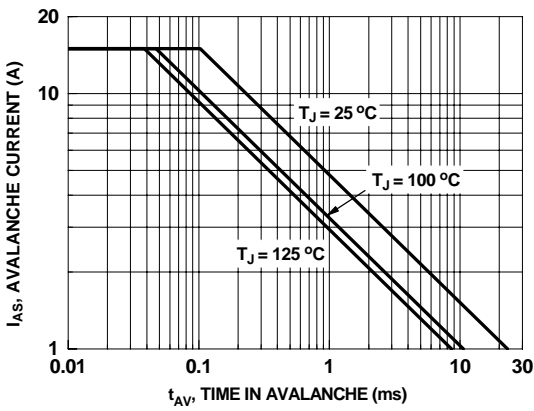

Figure 9. Unclamped Inductive Switching Capability

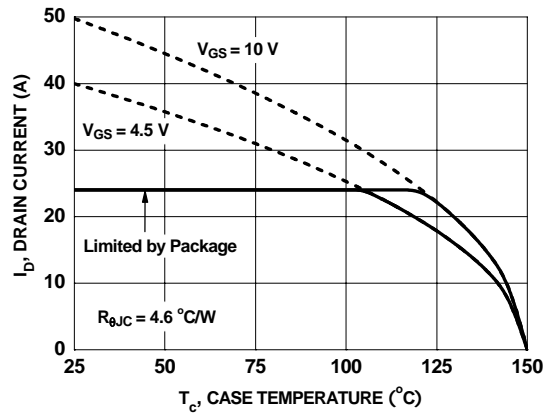

Figure 10. Maximum Continuous Drain Current vs Case Temperature

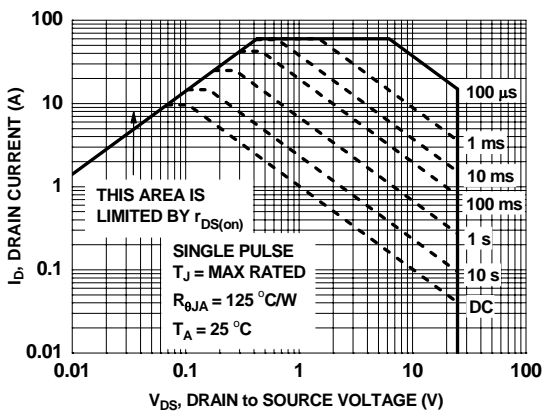

Figure 11. Forward Bias Safe Operating Area

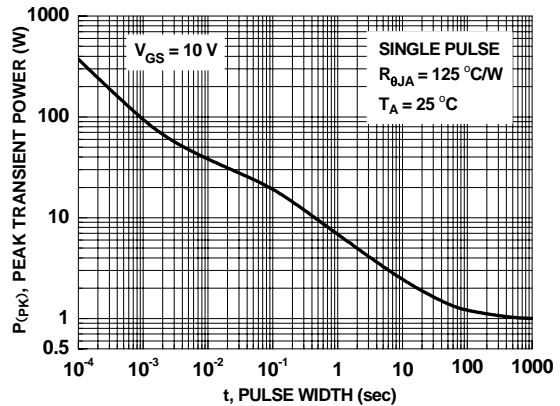

Figure 12. Single Pulse Maximum Power Dissipation

Typical Characteristics $T_J = 25\text{ }^\circ\text{C}$ unless otherwise noted

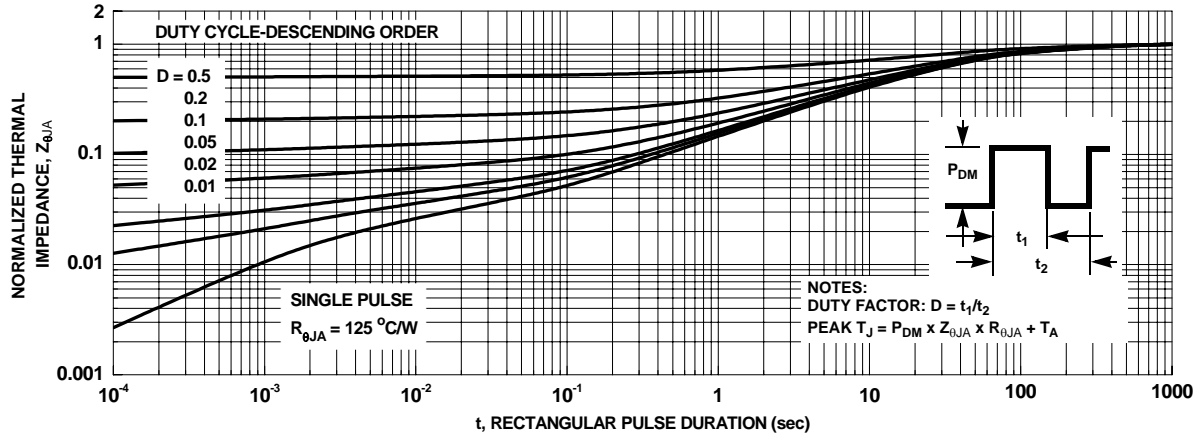
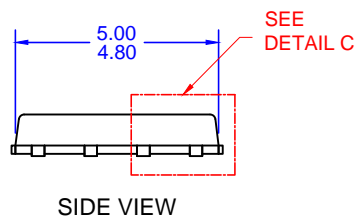
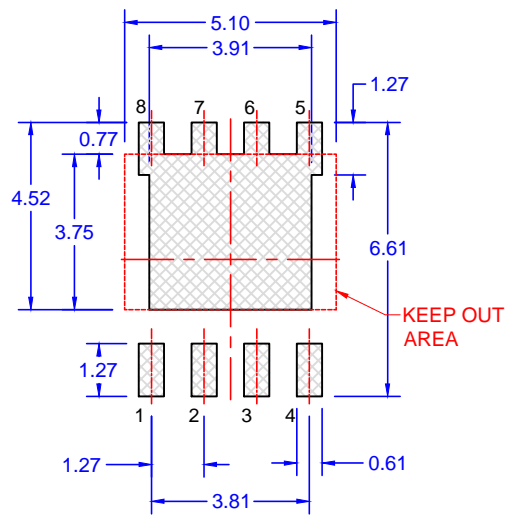
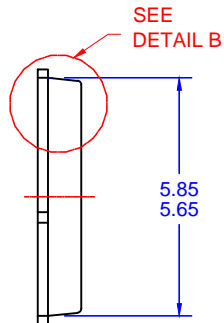
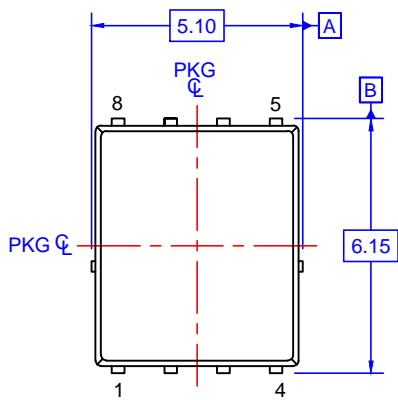
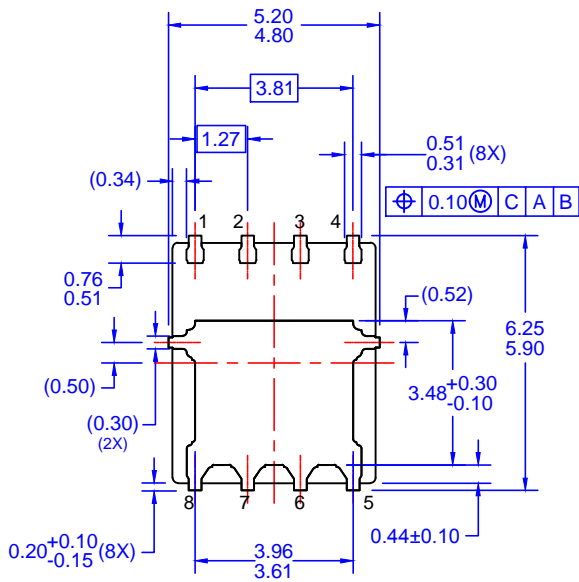
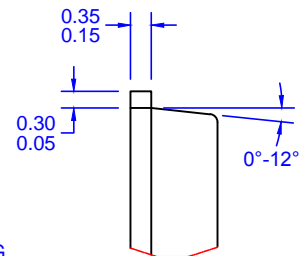
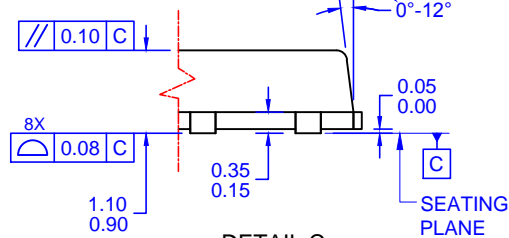

Figure 13. Transient Thermal Response Curve

PQFN8 5X6, 1.27P
CASE 483AE
ISSUE A



OPTIONAL DRAFT ANGLE MAY APPEAR ON FOUR SIDES OF THE PACKAGE



NOTES: UNLESS OTHERWISE SPECIFIED

- A. PACKAGE STANDARD REFERENCE: JEDEC MO-240, ISSUE A, VAR. AA.
- B. DIMENSIONS DO NOT INCLUDE BURRS OR MOLD FLASH. MOLD FLASH OR BURRS DOES NOT EXCEED 0.10MM.
- C. ALL DIMENSIONS ARE IN MILLIMETERS.
- D. DIMENSIONING AND TOLERANCING PER ASME Y14.5M-2009.
- E. IT IS RECOMMENDED TO HAVE NO TRACES OR VIAS WITHIN THE KEEP OUT AREA.

ON Semiconductor and  are trademarks of Semiconductor Components Industries, LLC dba ON Semiconductor or its subsidiaries in the United States and/or other countries. ON Semiconductor owns the rights to a number of patents, trademarks, copyrights, trade secrets, and other intellectual property. A listing of ON Semiconductor's product/patent coverage may be accessed at www.onsemi.com/site/pdf/Patent-Marking.pdf. ON Semiconductor reserves the right to make changes without further notice to any products herein. ON Semiconductor makes no warranty, representation or guarantee regarding the suitability of its products for any particular purpose, nor does ON Semiconductor assume any liability arising out of the application or use of any product or circuit, and specifically disclaims any and all liability, including without limitation special, consequential or incidental damages. Buyer is responsible for its products and applications using ON Semiconductor products, including compliance with all laws, regulations and safety requirements or standards, regardless of any support or applications information provided by ON Semiconductor. "Typical" parameters which may be provided in ON Semiconductor data sheets and/or specifications can and do vary in different applications and actual performance may vary over time. All operating parameters, including "Typicals" must be validated for each customer application by customer's technical experts. ON Semiconductor does not convey any license under its patent rights nor the rights of others. ON Semiconductor products are not designed, intended, or authorized for use as a critical component in life support systems or any FDA Class 3 medical devices or medical devices with a same or similar classification in a foreign jurisdiction or any devices intended for implantation in the human body. Should Buyer purchase or use ON Semiconductor products for any such unintended or unauthorized application, Buyer shall indemnify and hold ON Semiconductor and its officers, employees, subsidiaries, affiliates, and distributors harmless against all claims, costs, damages, and expenses, and reasonable attorney fees arising out of, directly or indirectly, any claim of personal injury or death associated with such unintended or unauthorized use, even if such claim alleges that ON Semiconductor was negligent regarding the design or manufacture of the part. ON Semiconductor is an Equal Opportunity/Affirmative Action Employer. This literature is subject to all applicable copyright laws and is not for resale in any manner.

PUBLICATION ORDERING INFORMATION

LITERATURE FULFILLMENT:

Literature Distribution Center for ON Semiconductor
19521 E. 32nd Pkwy, Aurora, Colorado 80011 USA
Phone: 303-675-2175 or 800-344-3860 Toll Free USA/Canada
Fax: 303-675-2176 or 800-344-3867 Toll Free USA/Canada
Email: orderlit@onsemi.com

N. American Technical Support: 800-282-9855 Toll Free
USA/Canada
Europe, Middle East and Africa Technical Support:
Phone: 421 33 790 2910
Japan Customer Focus Center
Phone: 81-3-5817-1050

ON Semiconductor Website: www.onsemi.com
Order Literature: <http://www.onsemi.com/orderlit>
For additional information, please contact your local
Sales Representative

Mouser Electronics

Authorized Distributor

Click to View Pricing, Inventory, Delivery & Lifecycle Information:

[ON Semiconductor:](#)

[FDMS7580](#)



Компания «ЭлектроПласт» предлагает заключение долгосрочных отношений при поставках импортных электронных компонентов на взаимовыгодных условиях!

Наши преимущества:

- Оперативные поставки широкого спектра электронных компонентов отечественного и импортного производства напрямую от производителей и с крупнейших мировых складов;
- Поставка более 17-ти миллионов наименований электронных компонентов;
- Поставка сложных, дефицитных, либо снятых с производства позиций;
- Оперативные сроки поставки под заказ (от 5 рабочих дней);
- Экспресс доставка в любую точку России;
- Техническая поддержка проекта, помощь в подборе аналогов, поставка прототипов;
- Система менеджмента качества сертифицирована по Международному стандарту ISO 9001;
- Лицензия ФСБ на осуществление работ с использованием сведений, составляющих государственную тайну;
- Поставка специализированных компонентов (Xilinx, Altera, Analog Devices, Intersil, Interpoint, Microsemi, Aeroflex, Peregrine, Syfer, Eurofarad, Texas Instrument, Miteq, Cobham, E2V, MA-COM, Hittite, Mini-Circuits, General Dynamics и др.);

Помимо этого, одним из направлений компании «ЭлектроПласт» является направление «Источники питания». Мы предлагаем Вам помощь Конструкторского отдела:

- Подбор оптимального решения, техническое обоснование при выборе компонента;
- Подбор аналогов;
- Консультации по применению компонента;
- Поставка образцов и прототипов;
- Техническая поддержка проекта;
- Защита от снятия компонента с производства.



Как с нами связаться

Телефон: 8 (812) 309 58 32 (многоканальный)

Факс: 8 (812) 320-02-42

Электронная почта: org@eplast1.ru

Адрес: 198099, г. Санкт-Петербург, ул. Калинина, дом 2, корпус 4, литера А.