



$V_{(BR)DSX} / V_{(BR)DGX}$	$R_{DS(on)}$ (max)	$I_{DSS}$ (min)	Package
250V <sub>p</sub>	10Ω	220mA	SOT-89

### Features

- Low  $R_{DS(on)}$  at Cold Temperatures
- Low On-Resistance: 10Ω max. at 25°C
- High Input Impedance
- High Breakdown Voltage: 250V<sub>p</sub>
- Low  $V_{GS(off)}$  Voltage: -1.6 to -3.9V
- Small Package Size SOT-89

### Applications

- Ignition Modules
- Normally-On Switches
- Solid State Relays
- Converters
- Telecommunications
- Power Supply

### Description

The CPC3710 is an N-channel, depletion-mode, field effect transistor (FET) that utilizes IXYS Integrated Circuits Division's proprietary third-generation vertical DMOS process. The third-generation process realizes world class, high voltage MOSFET performance in an economical silicon gate process. Our vertical DMOS process yields a robust device, with high input impedance, for use in high-power applications. The CPC3710 is a highly reliable FET device that has been used extensively in our solid state relays for industrial and telecommunications applications.

This device excels in power applications requiring low drain-source resistance, particularly in cold environments such as automotive ignition modules. The CPC3710 offers a low, 10Ω maximum, on-state resistance at 25°C.

The CPC3710 has a minimum breakdown voltage of 250V<sub>p</sub>, and is available in an SOT-89 package. As with all MOS devices, the FET structure prevents thermal runaway and thermal-induced secondary breakdown.

### Ordering Information

Part #	Description
CPC3710CTR	N-Channel Depletion Mode FET, SOT-89 Pkg. Tape and Reel (1000/Reel)

### Package Pinout

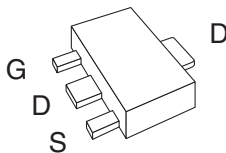

(SOT-89)

### Circuit Symbol

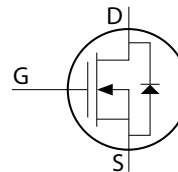

### Absolute Maximum Ratings @ 25°C

Parameter	Ratings	Units
Drain-to-Source Voltage	250	V <sub>P</sub>
Gate-to-Source Voltage	±15	V <sub>P</sub>
Pulsed Drain Current	600	mA
Total Package Dissipation <sup>1</sup>	1.4	W
Junction Temperature	150	°C
Operational Temperature	-55 to +125	°C
Storage Temperature	-55 to +125	°C

<sup>1</sup> Mounted on FR4 board 1"x1"x0.062"

Absolute Maximum Ratings are stress ratings. Stresses in excess of these ratings can cause permanent damage to the device. Functional operation of the device at conditions beyond those indicated in the operational sections of this data sheet is not implied.

### Electrical Characteristics @ 25°C (Unless Otherwise Noted)

Parameter	Symbol	Conditions	Min	Typ	Max	Units
Drain-to-Source Breakdown Voltage	V <sub>(BR)DSX</sub>	V <sub>GS</sub> = -5V, I <sub>D</sub> = 100µA	250	-	-	V <sub>P</sub>
Gate-to-Source Off Voltage	V <sub>GS(off)</sub>	V <sub>DS</sub> = 5V, I <sub>D</sub> = 1mA	-1.6	-	-3.9	V
Change in V <sub>GS(off)</sub> with Temperatures	dV <sub>GS(off)</sub> /dT	V <sub>DS</sub> = 5V, I <sub>D</sub> = 1µA	-	-	4.5	mV / °C
Gate Body Leakage Current	I <sub>GSS</sub>	V <sub>GS</sub> = ±15V, V <sub>DS</sub> = 0V	-	-	100	nA
Drain-to-Source Leakage Current	I <sub>D(off)</sub>	V <sub>GS</sub> = -5V, V <sub>DS</sub> = 250V	-	-	1	µA
		V <sub>GS</sub> = -5V, V <sub>DS</sub> = 200V, T <sub>A</sub> = 125°C	-	-	1	mA
Saturated Drain-to-Source Current	I <sub>DSS</sub>	V <sub>GS</sub> = 0V, V <sub>DS</sub> = 15V	220	-	-	mA
Static Drain-to-Source On-State Resistance	R <sub>DS(on)</sub>	V <sub>GS</sub> = 0V, I <sub>D</sub> = 220mA	-	-	10	Ω
Change in R <sub>DS(on)</sub> with Temperatures	dR <sub>DS(on)</sub> /dT	V <sub>GS</sub> = 0V, I <sub>D</sub> = 220mA	-	-	1.1	% / °C
Forward Transconductance	G <sub>FS</sub>	I <sub>D</sub> = 100mA, V <sub>DS</sub> = 10V	225	-	-	mΩ
Input Capacitance	C <sub>ISS</sub>	V <sub>GS</sub> = -5V V <sub>DS</sub> = 25V f = 1MHz	-	100	350	pF
Common Source Output Capacitance	C <sub>OSS</sub>		30	80		
Reverse Transfer Capacitance	C <sub>RSS</sub>		15	40		
Turn-On Delay Time	t <sub>d(on)</sub>	V <sub>DD</sub> = 25V I <sub>D</sub> = 150mA V <sub>GS</sub> = 0V to -10V R <sub>gen</sub> = 50Ω	-	23	35	ns
Rise Time	t <sub>r</sub>		8	20		
Turn-Off Delay Time	t <sub>d(off)</sub>		17	25		
Fall time	t <sub>f</sub>		70	80		
Source-Drain Diode Voltage Drop	V <sub>SD</sub>	V <sub>GS</sub> = -5V, I <sub>SD</sub> = 150mA	-	0.6	1.8	V
Thermal Resistance (Junction to Ambient)	R <sub>θJA</sub>	-	-	90	-	°C/W

### Switching Waveform & Test Circuit

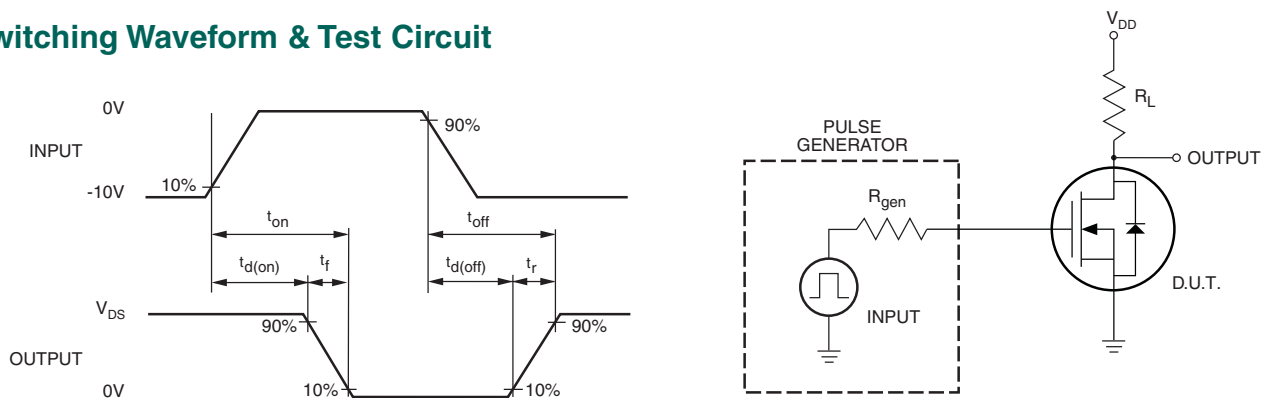

PERFORMANCE DATA\*

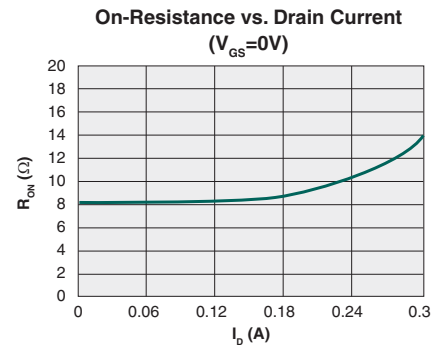
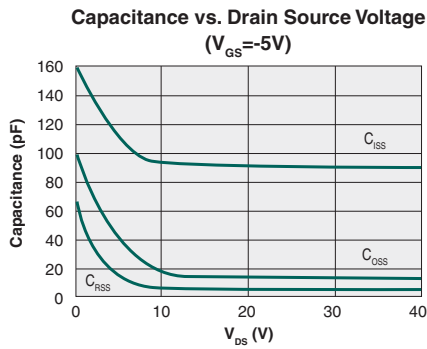
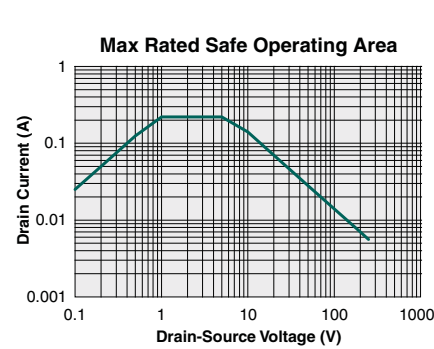
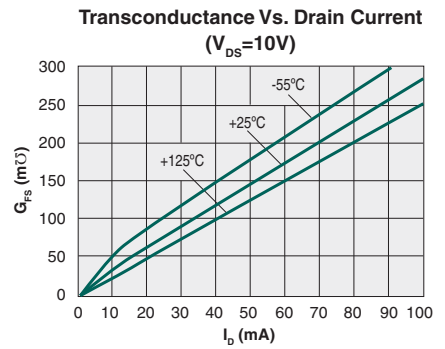
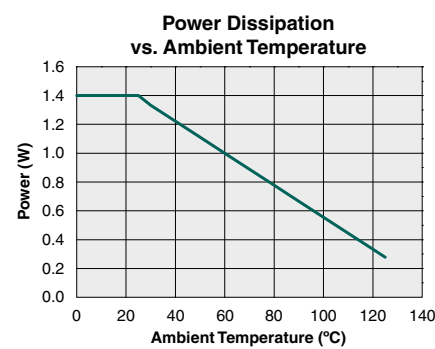
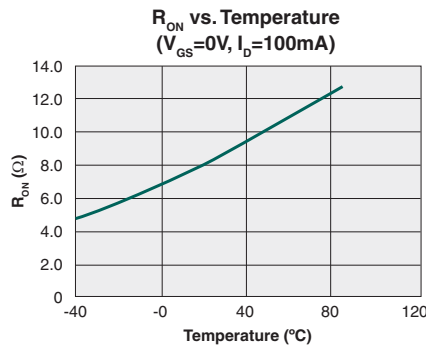
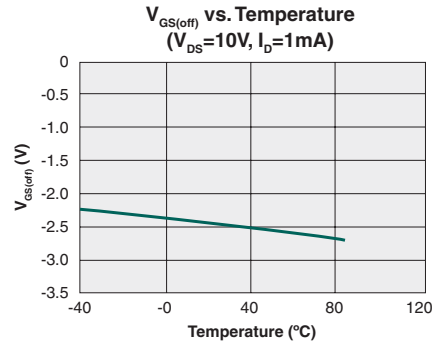
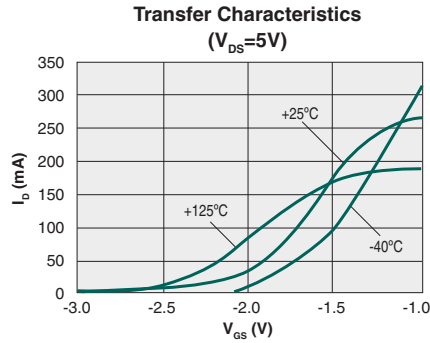
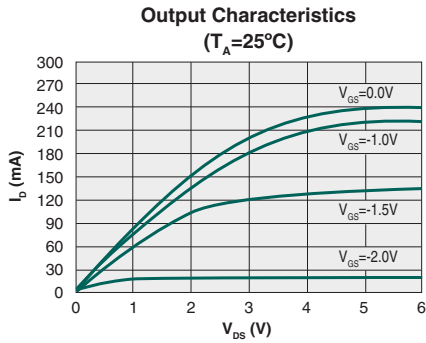

\*The Performance data shown in the graphs above is typical of device performance. For guaranteed parameters not indicated in the written specifications, please contact our application department.

## Manufacturing Information

### Moisture Sensitivity



All plastic encapsulated semiconductor packages are susceptible to moisture ingress. IXYS Integrated Circuits Division classified all of its plastic encapsulated devices for moisture sensitivity according to the latest version of the joint industry standard, **IPC/JEDEC J-STD-020**, in force at the time of product evaluation. We test all of our products to the maximum conditions set forth in the standard, and guarantee proper operation of our devices when handled according to the limitations and information in that standard as well as to any limitations set forth in the information or standards referenced below.

Failure to adhere to the warnings or limitations as established by the listed specifications could result in reduced product performance, reduction of operable life, and/or reduction of overall reliability.

This product carries a **Moisture Sensitivity Level (MSL) rating** as shown below, and should be handled according to the requirements of the latest version of the joint industry standard **IPC/JEDEC J-STD-033**.

Device	Moisture Sensitivity Level (MSL) Rating
CPC3710C	MSL 1

### ESD Sensitivity



This product is **ESD Sensitive**, and should be handled according to the industry standard **JESD-625**.

### Reflow Profile

This product has a maximum body temperature and time rating as shown below. All other guidelines of **J-STD-020** must be observed.

Device	Maximum Temperature x Time
CPC3710C	260°C for 30 seconds

### Board Wash

IXYS Integrated Circuits Division recommends the use of no-clean flux formulations. However, board washing to remove flux residue is acceptable, and the use of a short drying bake may be necessary. Chlorine-based or Fluorine-based solvents or fluxes should not be used. Cleaning methods that employ ultrasonic energy should not be used.



## MECHANICAL DIMENSIONS

### CPC3710C

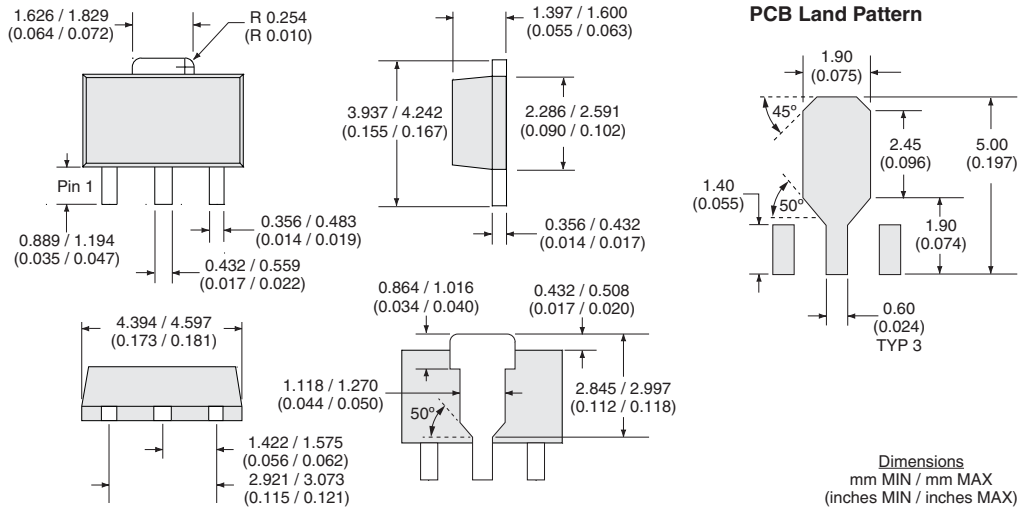

### CPC3710CTR Tape & Reel

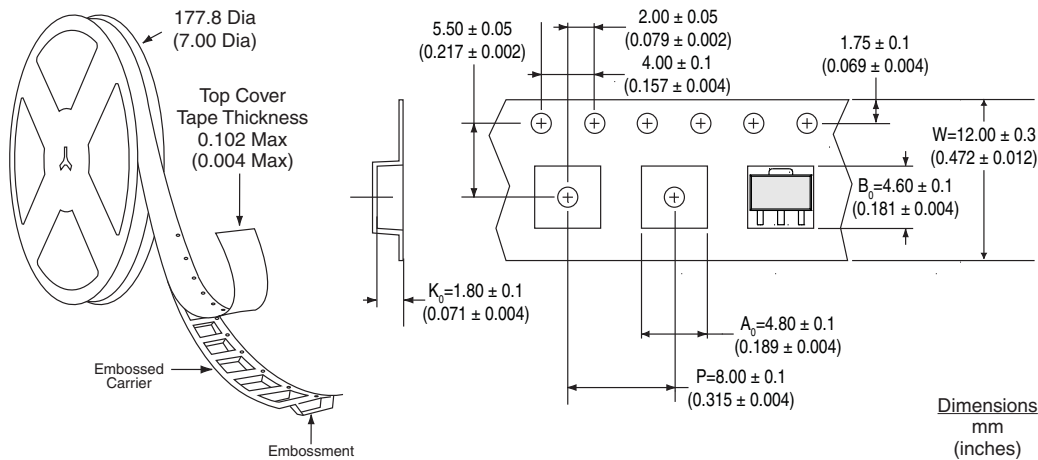

For additional information please visit our website at: [www.ixysic.com](http://www.ixysic.com)

IXYS Integrated Circuits Division makes no representations or warranties with respect to the accuracy or completeness of the contents of this publication and reserves the right to make changes to specifications and product descriptions at any time without notice. Neither circuit patent licenses nor indemnity are expressed or implied. Except as set forth in IXYS Integrated Circuits Division's Standard Terms and Conditions of Sale, IXYS Integrated Circuits Division assumes no liability whatsoever, and disclaims any express or implied warranty, relating to its products including, but not limited to, the implied warranty of merchantability, fitness for a particular purpose, or infringement of any intellectual property right.

The products described in this document are not designed, intended, authorized or warranted for use as components in systems intended for surgical implant into the body, or in other applications intended to support or sustain life, or where malfunction of IXYS Integrated Circuits Division's product may result in direct physical harm, injury, or death to a person or severe property or environmental damage. IXYS Integrated Circuits Division reserves the right to discontinue or make changes to its products at any time without notice.



Компания «ЭлектроПласт» предлагает заключение долгосрочных отношений при поставках импортных электронных компонентов на взаимовыгодных условиях!

Наши преимущества:

- Оперативные поставки широкого спектра электронных компонентов отечественного и импортного производства напрямую от производителей и с крупнейших мировых складов;
- Поставка более 17-ти миллионов наименований электронных компонентов;
- Поставка сложных, дефицитных, либо снятых с производства позиций;
- Оперативные сроки поставки под заказ (от 5 рабочих дней);
- Экспресс доставка в любую точку России;
- Техническая поддержка проекта, помощь в подборе аналогов, поставка прототипов;
- Система менеджмента качества сертифицирована по Международному стандарту ISO 9001;
- Лицензия ФСБ на осуществление работ с использованием сведений, составляющих государственную тайну;
- Поставка специализированных компонентов (Xilinx, Altera, Analog Devices, Intersil, Interpoint, Microsemi, Aeroflex, Peregrine, Syfer, Eurofarad, Texas Instrument, Miteq, Cobham, E2V, MA-COM, Hittite, Mini-Circuits, General Dynamics и др.);

Помимо этого, одним из направлений компании «ЭлектроПласт» является направление «Источники питания». Мы предлагаем Вам помощь Конструкторского отдела:

- Подбор оптимального решения, техническое обоснование при выборе компонента;
- Подбор аналогов;
- Консультации по применению компонента;
- Поставка образцов и прототипов;
- Техническая поддержка проекта;
- Защита от снятия компонента с производства.



#### Как с нами связаться

**Телефон:** 8 (812) 309 58 32 (многоканальный)

**Факс:** 8 (812) 320-02-42

**Электронная почта:** [org@eplast1.ru](mailto:org@eplast1.ru)

**Адрес:** 198099, г. Санкт-Петербург, ул. Калинина, дом 2, корпус 4, литера А.