

HC/49US (AT49) LOW PROFILE SURFACE MOUNT MICROPROCESSOR CRYSTAL

ABLS2

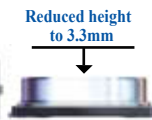

RoHS
Compliant



11.4 x 4.7 x 3.3 mm

FEATURES:

- Suitable for RoHS compliant reflow
- Low height reduced to 3.3mm
- Available suitable for thin equipment
- Tight stability & extended temperature

APPLICATIONS:

- Computers, Modems, Microprocessors
- Automotive and Industrial *
- Wireless Applications

STANDARD SPECIFICATIONS:

Parameters	Minimum	Typical	Maximum	Units	Notes
Frequency Range	3.579545	-----	24.00	MHz	Fundamental AT (Standard)
	24.01	-----	50.00		Fundamental AT or BT (See options)
	24.01	-----	70.00		3 rd Overtone (Standard)
Operation Mode	Fundamental or 3 rd Overtone				
Operating Temperature	0	-----	+70	°C	See options
Storage Temperature	-55	-----	+125	°C	
Frequency Tolerance @+25°C	-50	-----	+50	ppm	See options
Frequency Stability over the Operating Temperature (ref. to +25°C)	-50	-----	+50	ppm	See options (For BT cut, ±100ppm max.at -10° C to +60° C only)
Equivalent series resistance (R1)	See table 1 below			Ω	
Shunt capacitance (C0)	-----	-----	7	pF	
Load capacitance (CL)	-----	18	-----	pF	Standard (See options if other than STD)
Drive Level	-----	100	1000	μW	
Aging	-5	-----	+5	ppm	@25°C±3°C First year
Insulation Resistance	500	-----	-----	MΩ	@ 100Vdc ± 15V
Drive level dependency (DLD)	Minimum 7 points tested: from 1μW to 500μW. Change in frequency (Maximum - Minimum) over DLD range < ±10ppm Change in ESR (Maximum - Minimum) over DLD range < 25% of Max ESR value. Maximum ESR over DLD range < Max ESR value.				

TABLE 1: ESR

FREQUENCY (MHz)	ESR (Ω)
3.579545 - 4.999 (Fund.)	180
5.000 - 5.999 (Fund.)	120
6.000 - 7.999 (Fund.)	100
8.000 - 8.999 (Fund.)	80
9.000 - 9.999 (Fund.)	60
10.000 - 15.999 (Fund.)	50
16.000 - 50.000 (Fund.)	40
24.01 - 31.999 (3rd O/T)	100
32.000 - 70.00 (3rd O/T)	80



HC/49US (AT49) LOW PROFILE SURFACE MOUNT MICROPROCESSOR CRYSTAL

ABLS2



RoHS
Compliant



Reduced height
to 3.3mm

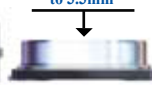

11.4 x 4.7 x 3.3 mm

Options and Part Identification

(left blank if standard)

ABLS2 - MHz - - - - -

Frequency in MHz

Please specify the frequency in MHz. e.g. 14.31818MHz

Load Capacitance (pF)

Please specify CL (Minimum 10pF) in pF or S for series

Custom ESR if other than standard

R
□: Specify a value in Ω (e.g.: R40)

Operating Temp.

A: -10°C ~ +60°C
B: -20°C ~ +70°C
C: -30°C ~ +70°C
N: -30°C ~ +85°C
D: -40°C ~ +85°C
J*: -40°C ~ +105°C
K*: -40°C ~ +125°C
L*: -55°C ~ +125°C

Freq. Tolerance

H5: ± 5 ppm
1: ± 10 ppm
7: ± 15 ppm
2: ± 20 ppm
3: ± 25 ppm
4: ± 30 ppm

Freq. Stability

U**: ± 10 ppm
G: ± 15 ppm
X: ± 20 ppm
W: ± 25 ppm
Y: ± 30 ppm
H: ± 35 ppm
Q: ± 100 ppm
R: ± 150 ppm

Packaging

Blank: Bulk
T: Tape&Reel

Oscillation Mode

F: Fund. AT>24MHz
FB: Fund. BT>24MHz

NOTE: Fundamental BT frequency stability ± 100ppm max. at -10° C to +60° C only.

* Frequency stability ±50ppm, ±100ppm, ±150ppm only. Contact ABRACON for tighter frequency stability.

** -10 to +60C only.



HC/49US (AT49) LOW PROFILE SURFACE MOUNT MICROPROCESSOR CRYSTAL

ABLS2



RoHS
Compliant

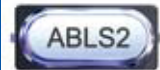

11.4 x 4.7 x 3.3 mm

Reduced height to 3.3mm

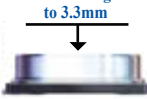

OUTLINE DRAWING:

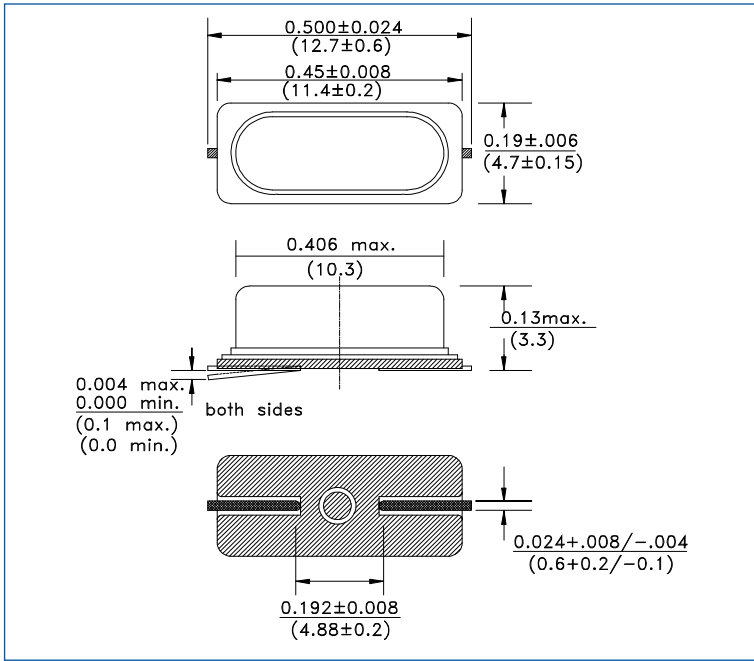

Recommended land pattern

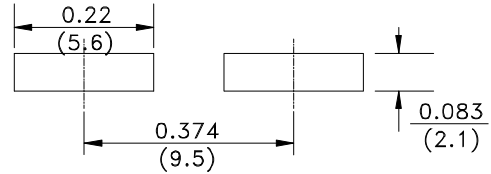

TAPE & REEL: T = tape and reel (1000pcs/reel)

Reflow Profile

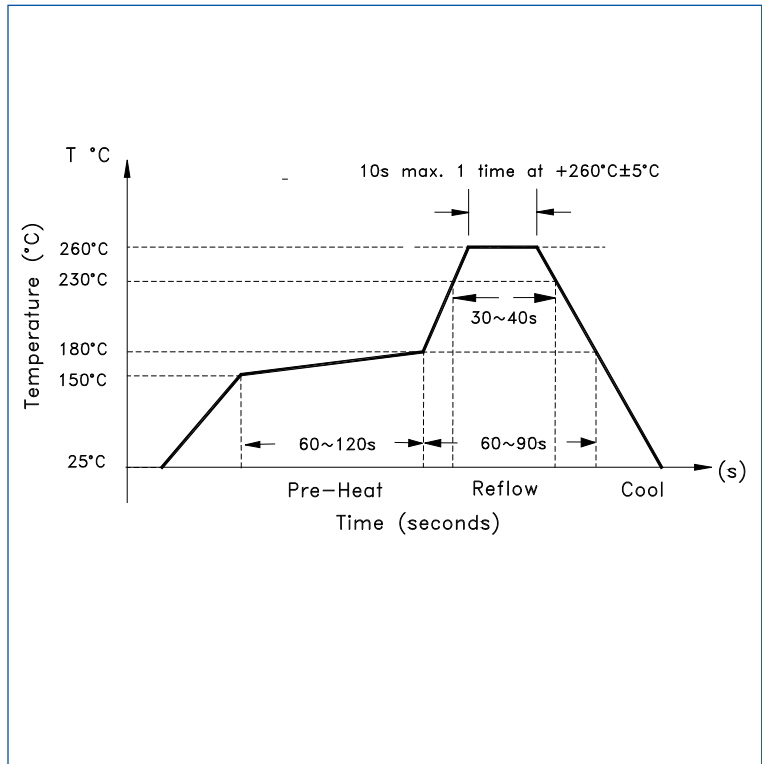
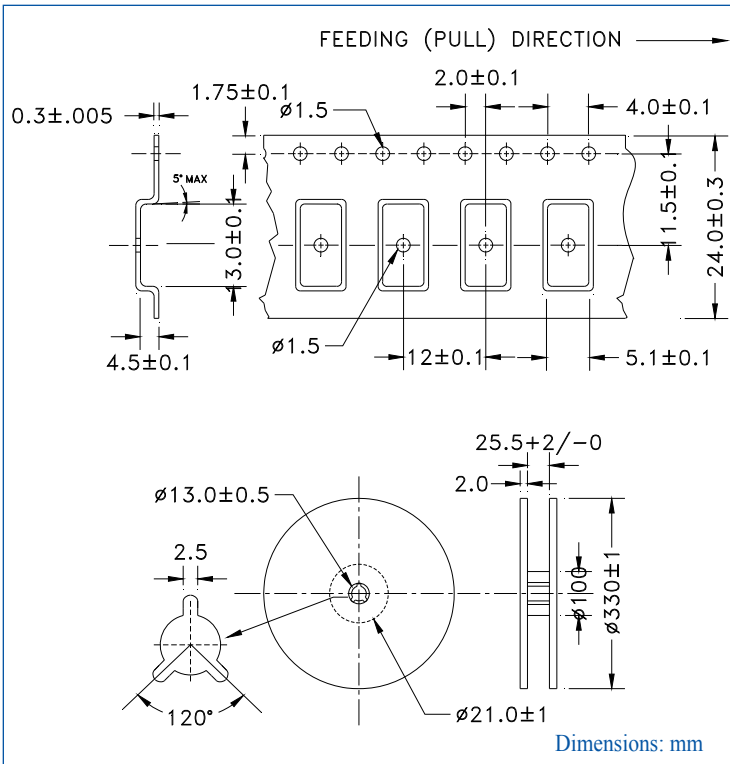

ATTENTION: Abracon Corporation's products are COTS – Commercial-Off-The-Shelf products; suitable for Commercial, Industrial and, where designated, Automotive Applications. Abracon's products are not specifically designed for Military, Aviation, Aerospace, Life-dependant Medical applications or any application requiring high reliability where component failure could result in loss of life and/or property. For applications requiring high reliability and/or presenting an extreme operating environment, written consent and authorization from Abracon Corporation is required. Please contact Abracon Corporation for more information.

ABRACON IS
ISO9001:2008
CERTIFIED

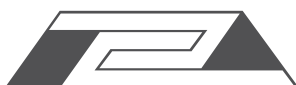

**ABRACON
CORPORATION**

Visit www.abracon.com for Terms & Conditions of Sale **Revised: 03.31.11**
 30332 Esperanza, Rancho Santa Margarita, California 92688
 tel 949-546-8000 | fax 949-546-8001 | www.abracon.com



Компания «ЭлектроПласт» предлагает заключение долгосрочных отношений при поставках импортных электронных компонентов на взаимовыгодных условиях!

Наши преимущества:

- Оперативные поставки широкого спектра электронных компонентов отечественного и импортного производства напрямую от производителей и с крупнейших мировых складов;
- Поставка более 17-ти миллионов наименований электронных компонентов;
- Поставка сложных, дефицитных, либо снятых с производства позиций;
- Оперативные сроки поставки под заказ (от 5 рабочих дней);
- Экспресс доставка в любую точку России;
- Техническая поддержка проекта, помощь в подборе аналогов, поставка прототипов;
- Система менеджмента качества сертифицирована по Международному стандарту ISO 9001;
- Лицензия ФСБ на осуществление работ с использованием сведений, составляющих государственную тайну;
- Поставка специализированных компонентов (Xilinx, Altera, Analog Devices, Intersil, Interpoint, Microsemi, Aeroflex, Peregrine, Syfer, Eurofarad, Texas Instrument, Miteq, Cobham, E2V, MA-COM, Hittite, Mini-Circuits, General Dynamics и др.);

Помимо этого, одним из направлений компании «ЭлектроПласт» является направление «Источники питания». Мы предлагаем Вам помощь Конструкторского отдела:

- Подбор оптимального решения, техническое обоснование при выборе компонента;
- Подбор аналогов;
- Консультации по применению компонента;
- Поставка образцов и прототипов;
- Техническая поддержка проекта;
- Защита от снятия компонента с производства.



Как с нами связаться

Телефон: 8 (812) 309 58 32 (многоканальный)

Факс: 8 (812) 320-02-42

Электронная почта: org@eplast1.ru

Адрес: 198099, г. Санкт-Петербург, ул. Калинина, дом 2, корпус 4, литера А.