

HC/49US (AT49) LOW PROFILE SURFACE MOUNT MICROPROCESSOR CRYSTAL

ABLS2

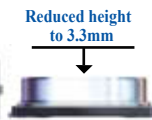

RoHS
Compliant



11.4 x 4.7 x 3.3 mm

FEATURES:

- Suitable for RoHS compliant reflow
- Low height reduced to 3.3mm
- Available suitable for thin equipment
- Tight stability & extended temperature

APPLICATIONS:

- Computers, Modems, Microprocessors
- Automotive and Industrial *
- Wireless Applications

STANDARD SPECIFICATIONS:

| Parameters | Minimum | Typical | Maximum | Units | Notes |
|---|---|---------|---------|-------|---|
| Frequency Range | 3.579545 | ----- | 24.00 | MHz | Fundamental AT (Standard) |
| | 24.01 | ----- | 50.00 | | Fundamental AT or BT (See options) |
| | 24.01 | ----- | 70.00 | | 3 rd Overtone (Standard) |
| Operation Mode | Fundamental or 3 rd Overtone | | | | |
| Operating Temperature | 0 | ----- | +70 | °C | See options |
| Storage Temperature | -55 | ----- | +125 | °C | |
| Frequency Tolerance @+25°C | -50 | ----- | +50 | ppm | See options |
| Frequency Stability over the Operating Temperature (ref. to +25°C) | -50 | ----- | +50 | ppm | See options (For BT cut, ±100ppm max.at -10° C to +60° C only) |
| Equivalent series resistance (R1) | See table 1 below | | | Ω | |
| Shunt capacitance (C0) | ----- | ----- | 7 | pF | |
| Load capacitance (CL) | ----- | 18 | ----- | pF | Standard (See options if other than STD) |
| Drive Level | ----- | 100 | 1000 | μW | |
| Aging | -5 | ----- | +5 | ppm | @25°C±3°C First year |
| Insulation Resistance | 500 | ----- | ----- | MΩ | @ 100Vdc ± 15V |
| Drive level dependency (DLD) | Minimum 7 points tested: from 1μW to 500μW. Change in frequency (Maximum - Minimum) over DLD range < ±10ppm Change in ESR (Maximum - Minimum) over DLD range < 25% of Max ESR value. Maximum ESR over DLD range < Max ESR value. | | | | |

TABLE 1: ESR

| FREQUENCY (MHz) | ESR (Ω) |
|--------------------------|---------|
| 3.579545 - 4.999 (Fund.) | 180 |
| 5.000 - 5.999 (Fund.) | 120 |
| 6.000 - 7.999 (Fund.) | 100 |
| 8.000 - 8.999 (Fund.) | 80 |
| 9.000 - 9.999 (Fund.) | 60 |
| 10.000 - 15.999 (Fund.) | 50 |
| 16.000 - 50.000 (Fund.) | 40 |
| 24.01 - 31.999 (3rd O/T) | 100 |
| 32.000 - 70.00 (3rd O/T) | 80 |



HC/49US (AT49) LOW PROFILE SURFACE MOUNT MICROPROCESSOR CRYSTAL

ABLS2



RoHS
Compliant



Reduced height to 3.3mm

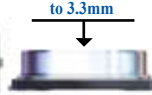

11.4 x 4.7 x 3.3 mm

Options and Part Identification

(left blank if standard)

ABLS2 - MHz - - - - -

Frequency in MHz

Please specify the frequency in MHz. e.g. 14.31818MHz

Load Capacitance (pF)

Please specify CL (Minimum 10pF) in pF or S for series

Custom ESR if other than standard

R
□: Specify a value in Ω (e.g.: R40)

Operating Temp.

| |
|--------------------|
| A: -10°C ~ +60°C |
| B: -20°C ~ +70°C |
| C: -30°C ~ +70°C |
| N: -30°C ~ +85°C |
| D: -40°C ~ +85°C |
| J*: -40°C ~ +105°C |
| K*: -40°C ~ +125°C |
| L*: -55°C ~ +125°C |

Freq. Tolerance

| |
|-------------|
| H5: ± 5 ppm |
| 1: ± 10 ppm |
| 7: ± 15 ppm |
| 2: ± 20 ppm |
| 3: ± 25 ppm |
| 4: ± 30 ppm |

Freq. Stability

| |
|---------------|
| U**: ± 10 ppm |
| G: ± 15 ppm |
| X: ± 20 ppm |
| W: ± 25 ppm |
| Y: ± 30 ppm |
| H: ± 35 ppm |
| Q: ± 100 ppm |
| R: ± 150 ppm |

Packaging

Blank: Bulk
T: Tape&Reel

Oscillation Mode

F: Fund. AT>24MHz
FB: Fund. BT>24MHz

NOTE: Fundamental BT frequency stability ± 100ppm max. at -10° C to +60° C only.

* Frequency stability ±50ppm, ±100ppm, ±150ppm only. Contact ABRACON for tighter frequency stability.

** -10 to +60C only.



HC/49US (AT49) LOW PROFILE SURFACE MOUNT MICROPROCESSOR CRYSTAL

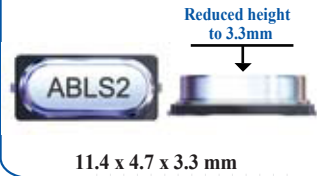

ABLS2



RoHS
Compliant

11.4 x 4.7 x 3.3 mm

OUTLINE DRAWING:

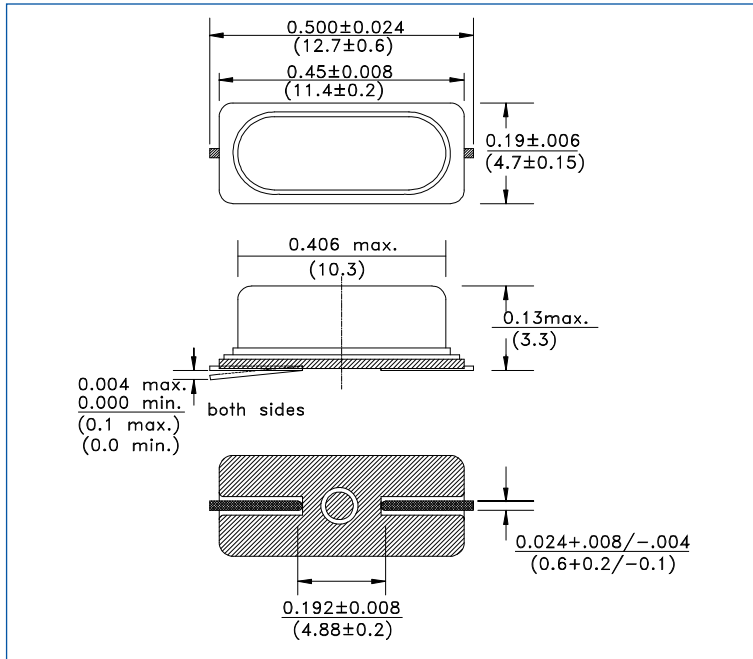

Recommended land pattern

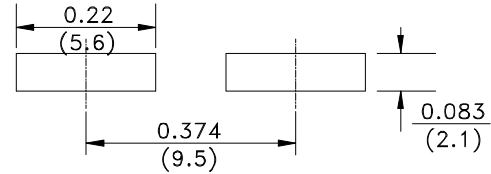

TAPE & REEL: T = tape and reel (1000pcs/reel)

Reflow Profile

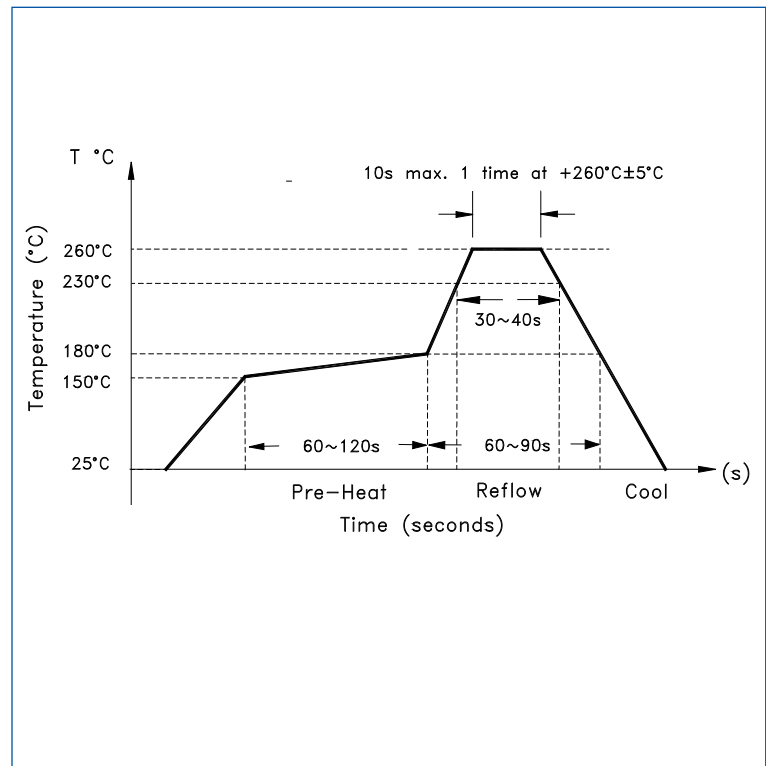
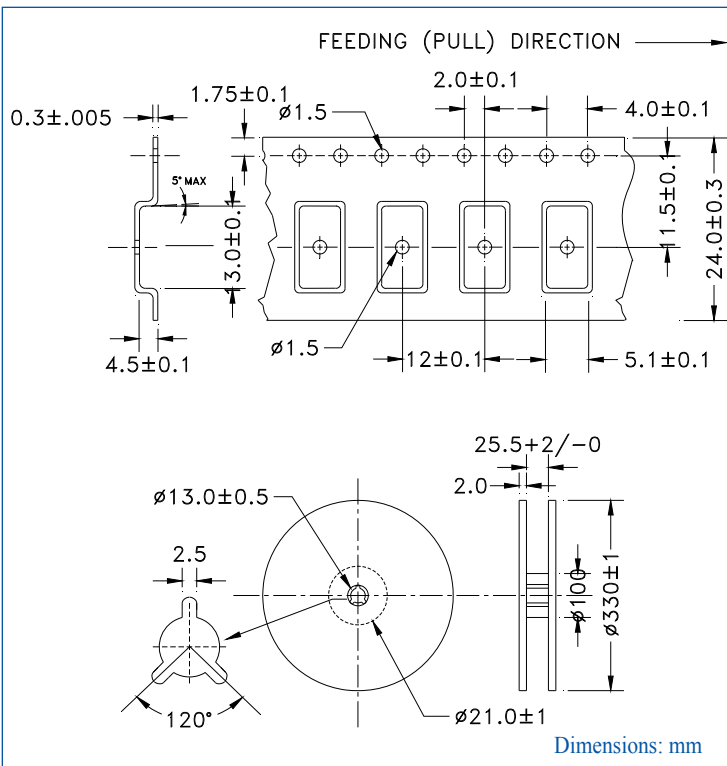

ATTENTION: Abracon Corporation's products are COTS – Commercial-Off-The-Shelf products; suitable for Commercial, Industrial and, where designated, Automotive Applications. Abracon's products are not specifically designed for Military, Aviation, Aerospace, Life-dependant Medical applications or any application requiring high reliability where component failure could result in loss of life and/or property. For applications requiring high reliability and/or presenting an extreme operating environment, written consent and authorization from Abracon Corporation is required. Please contact Abracon Corporation for more information.

ABRACON IS
ISO9001:2008
CERTIFIED



ABRACON
CORPORATION

Visit www.abracon.com for Terms & Conditions of Sale **Revised: 03.31.11**
30332 Esperanza, Rancho Santa Margarita, California 92688
tel 949-546-8000 | fax 949-546-8001 | www.abracon.com



Компания «ЭлектроПласт» предлагает заключение долгосрочных отношений при поставках импортных электронных компонентов на взаимовыгодных условиях!

Наши преимущества:

- Оперативные поставки широкого спектра электронных компонентов отечественного и импортного производства напрямую от производителей и с крупнейших мировых складов;
- Поставка более 17-ти миллионов наименований электронных компонентов;
- Поставка сложных, дефицитных, либо снятых с производства позиций;
- Оперативные сроки поставки под заказ (от 5 рабочих дней);
- Экспресс доставка в любую точку России;
- Техническая поддержка проекта, помощь в подборе аналогов, поставка прототипов;
- Система менеджмента качества сертифицирована по Международному стандарту ISO 9001;
- Лицензия ФСБ на осуществление работ с использованием сведений, составляющих государственную тайну;
- Поставка специализированных компонентов (Xilinx, Altera, Analog Devices, Intersil, Interpoint, Microsemi, Aeroflex, Peregrine, Syfer, Eurofarad, Texas Instrument, Miteq, Cobham, E2V, MA-COM, Hittite, Mini-Circuits, General Dynamics и др.);

Помимо этого, одним из направлений компании «ЭлектроПласт» является направление «Источники питания». Мы предлагаем Вам помощь Конструкторского отдела:

- Подбор оптимального решения, техническое обоснование при выборе компонента;
- Подбор аналогов;
- Консультации по применению компонента;
- Поставка образцов и прототипов;
- Техническая поддержка проекта;
- Защита от снятия компонента с производства.



Как с нами связаться

Телефон: 8 (812) 309 58 32 (многоканальный)

Факс: 8 (812) 320-02-42

Электронная почта: org@eplast1.ru

Адрес: 198099, г. Санкт-Петербург, ул. Калинина, дом 2, корпус 4, литера А.