

Product Description

The QORVO TGC4407-SM is a Ka-Band sub-harmonic upconverter with integrated LO buffer amplifier. The TGC4407-SM operates from an RF of 21.5 to 32.5 GHz and is designed using QORVO's pHEMT production process.

The TGC4407-SM typically provides 13 dBm of input TOI at -10 dBm input power per tone and a conversion gain of -9 dB.

The TGC4407-SM is available in a low-cost, surface mount 16 lead 3x3mm QFN package and is ideally suited for Point-to-Point Radio, and Ka-Band VSAT Ground Terminal.

Lead-free and RoHS compliant.

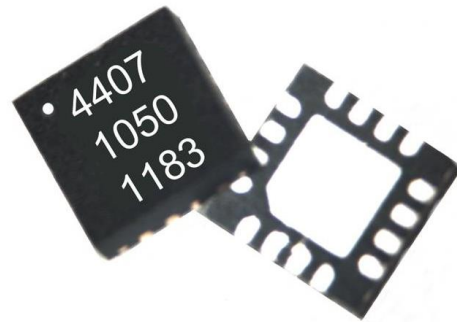

QFN 3x3 mm 16L

Applications

- VSAT
- Point-to-Point Radio
- Test Equipment & Sensors

Function Block Diagram

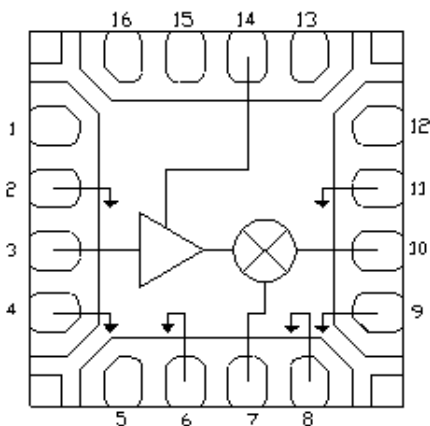

Product Features

- RF Frequency Range: 21.5 – 32.5 GHz
- Wideband IF Frequency: DC – 7.0 GHz
- Sub-Harmonic Pumped LO Frequency: 11 – 16 GHz
- LO Input Power: 0 to 7.5 dBm
- Conversion Gain: -9 dB
- Bias: $V_d = 5\text{ V}$, $I_d = 65\text{ mA}$, Typical
- Package Dimensions: 3.0 x 3.0 x 0.85 mm

Ordering Information

Part No.	Description
TGC4407-SM	Ka-Band Upconverter
TGC4407-SMEVB	TGC4407-SM EVB

Standard T/R size = 500 pieces on a 7" reel.

Absolute Maximum Ratings

Parameter	Rating
Drain Voltage, Vd	+7 V
Drain Current, Id	175 mA
Power Dissipation, P _{diss}	1.2 W
RF Input Power, CW, 50Ω, T = 25°C	+10 dBm
Channel Temperature, T _{ch}	200 °C
Mounting Temperature (30 seconds)	260 °C
Storage Temperature	-40 to 150°C

These are stress ratings only, functional operation of the device at these conditions is not implied. Extended application of Absolute Maximum Rating conditions may reduce device reliability. Operation of this device outside the parameter ranges given above may cause permanent damage.

Recommended Operating Conditions

Parameter	Min	Typ	Max	Units
Operating Temp. Range	-40	+25	+85	°C
Vd	4	5	6	V
Id		65		mA
Id _{drive} (Under RF Drive)		76		mA

Electrical specifications are measured at specified test conditions. Specifications are not guaranteed over all recommended operating conditions.

Electrical Specifications

Test conditions unless otherwise noted: 25°C, Vd = 5 V, Id = 65 mA Typical. IF = 500 MHz, LO = 0 dBm.
LSB = 2 x LO – IF and USB = 2 x LO + IF.

Parameter	Conditions	Min	Typ	Max	Units
RF Frequency Range		21.5		31.5	GHz
LO Frequency Range		11		16	GHz
IF Frequency Range		DC		7	GHz
Conversion Gain			-9		dB
Noise Figure			9		dB
2LO-to-RF Isolation, OIP3			35		dB
Input IP3			13		dBm
Input 1dB Compression (P1dB)			4		dBm
Supply Current			65		mA

Thermal and Reliability Information

Parameter	Conditions	Rating
Thermal Resistance, θ_{JC} , measured to back of package	Tbase = 85 °C	$\theta_{JC} = 47$ °C/W
Channel Temperature (Tch), and Median Lifetime (Tm)	Tbase = 85 °C, Vd = 5 V, Id = 65 mA Pdis = 0.325 W	Tch = 100 °C Tm = 2.9 E+11 Hours
Channel Temperature (Tch), and Median Lifetime (Tm) Under RF Drive	Tbase = 85 °C Vd = 5 V, Id_drive = 76 mA Pin = 7 dBm, Pdis = 0.38 W	Tch = 103 °C Tm = 2.2 E+11 Hours

Test Conditions: $V_D = +6$ V; Failure Criteria = 10% reduction in I_{D_MAX} during DC Life Testing

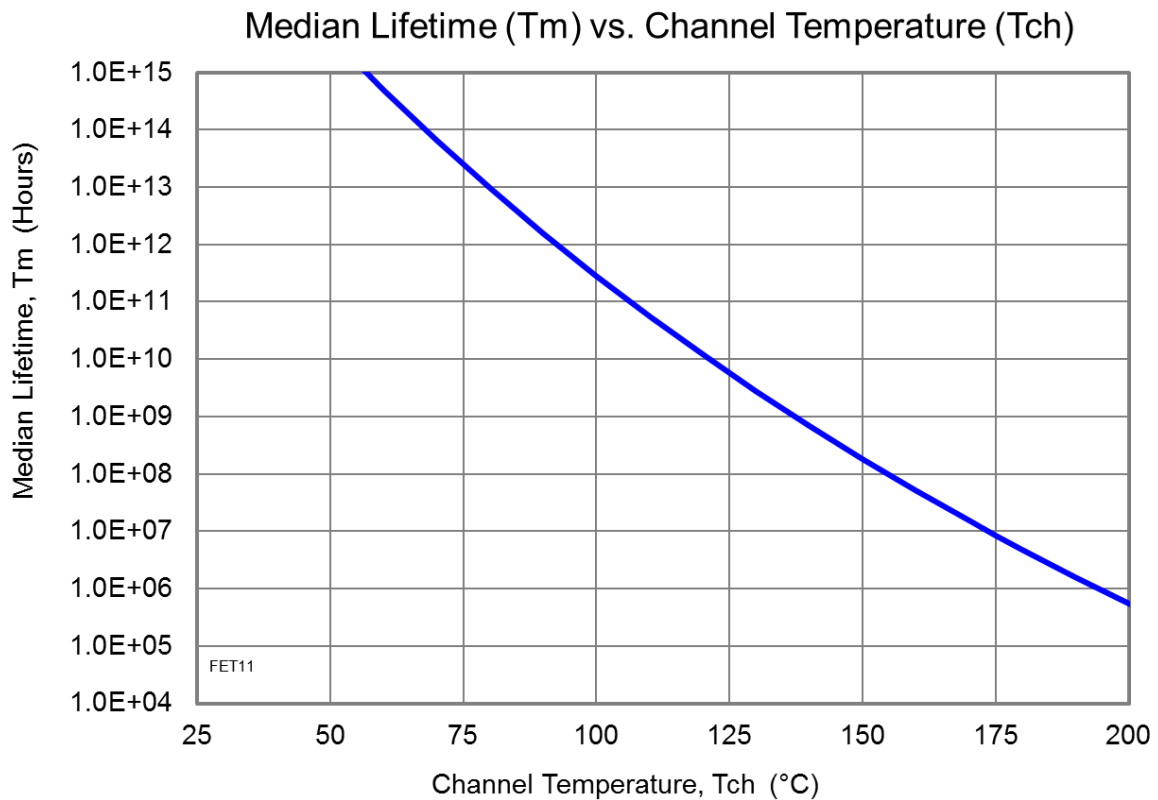

Performance Plots

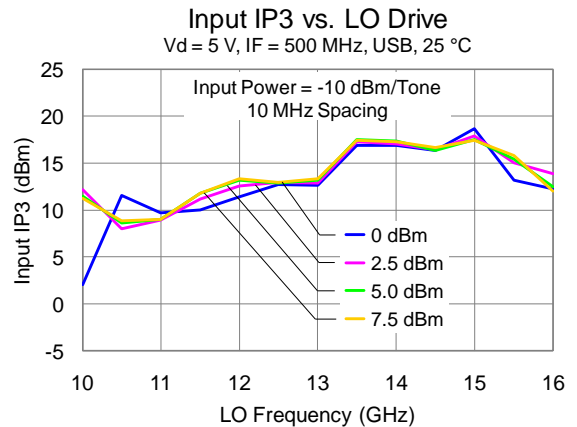
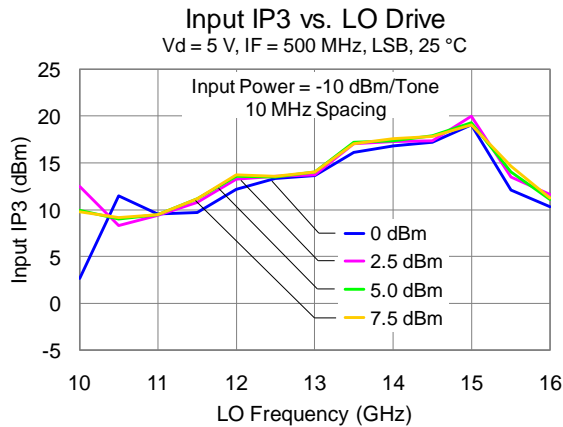
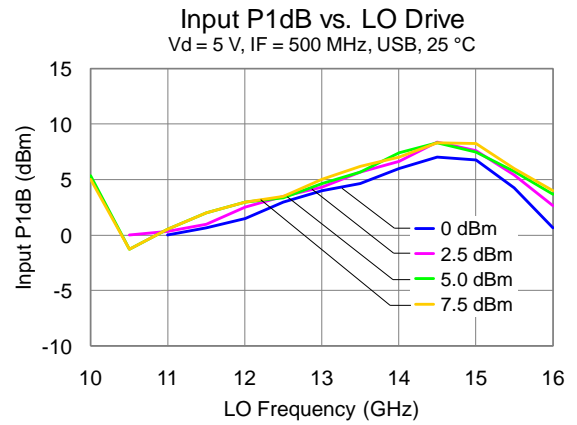
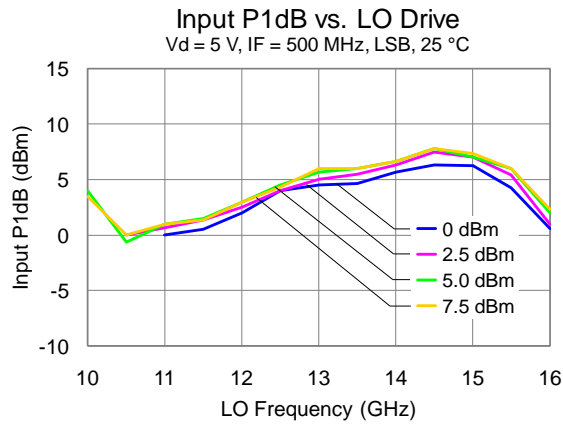
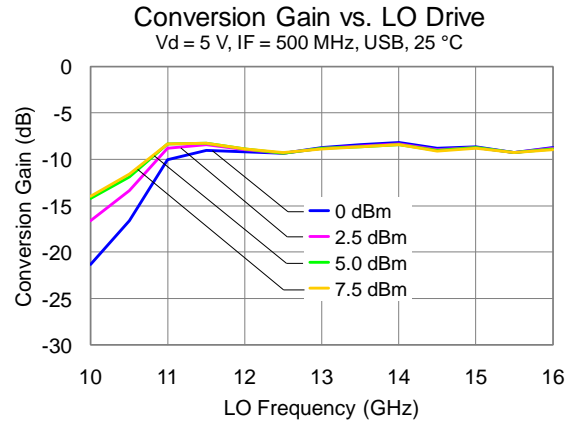
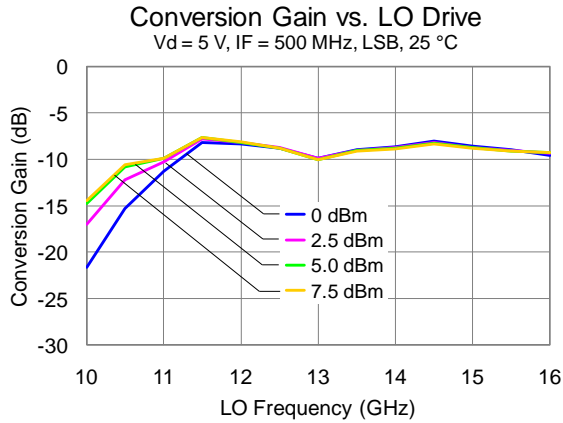

Performance Plots

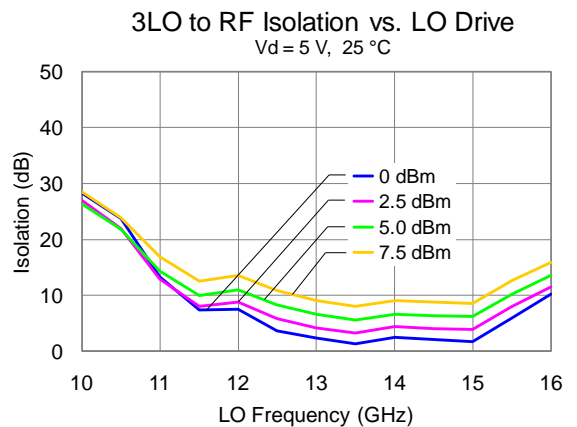
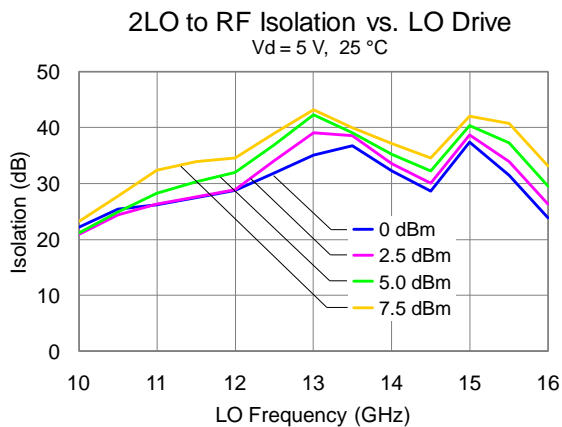
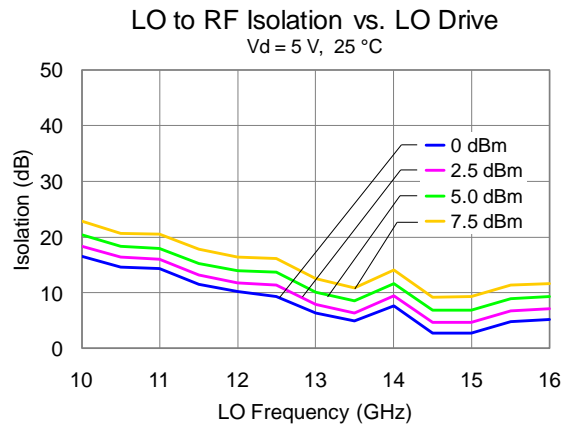
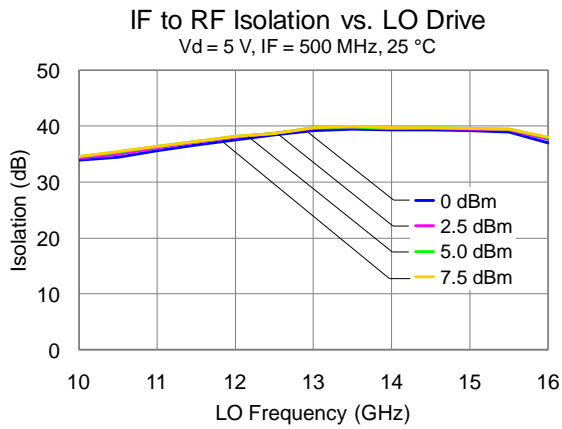
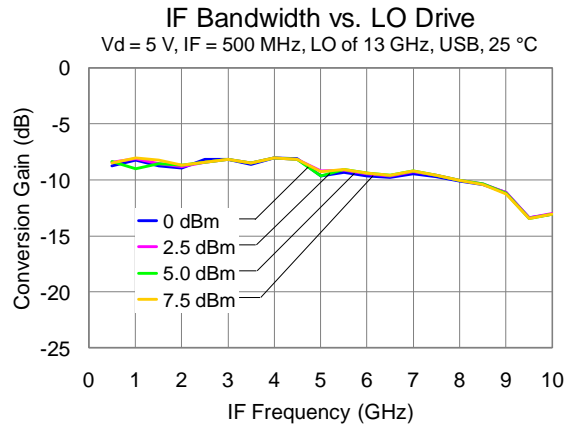
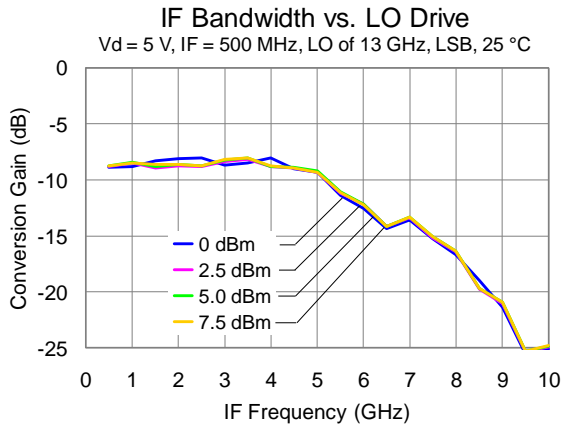

Performance Plots

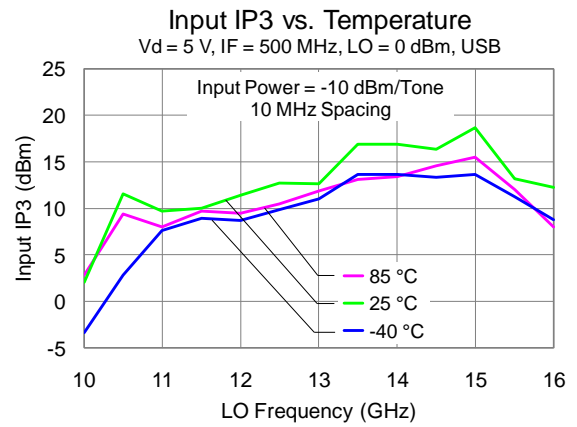
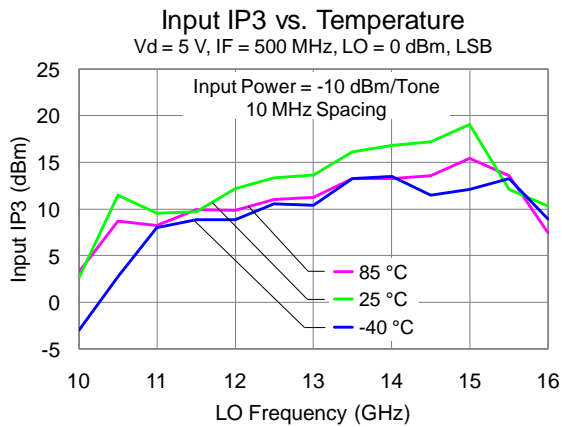
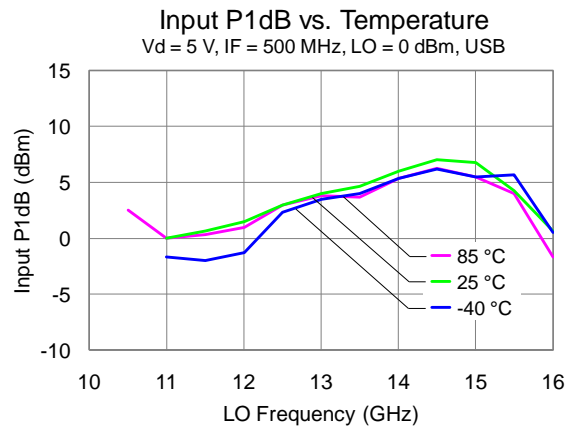
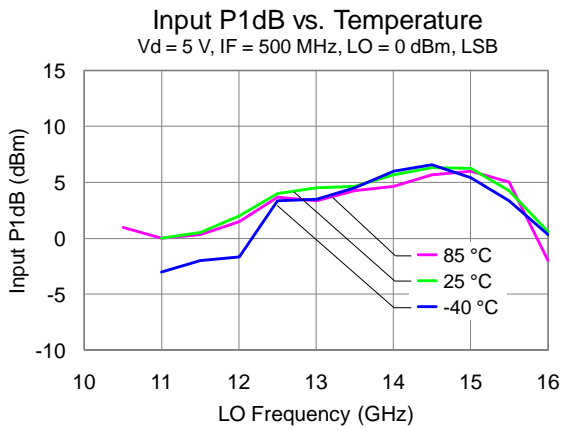
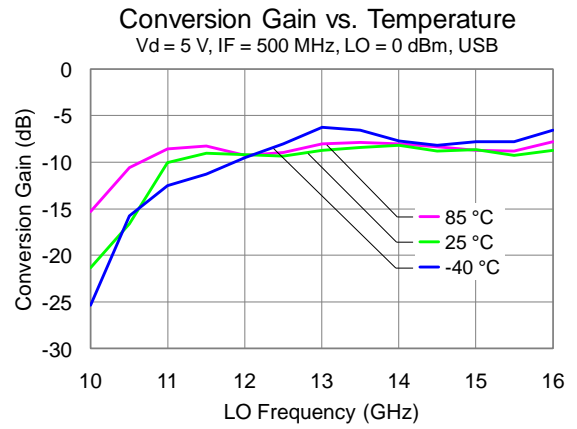
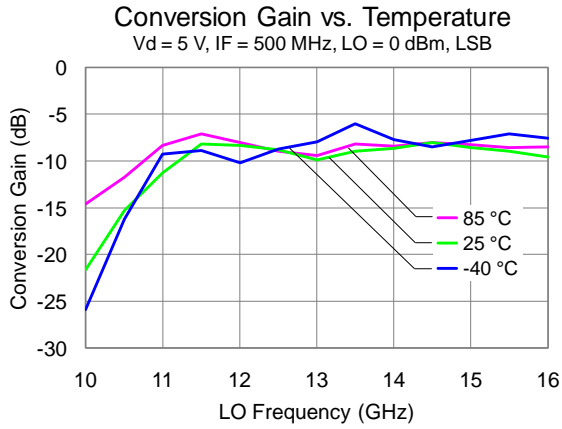

Performance Plots

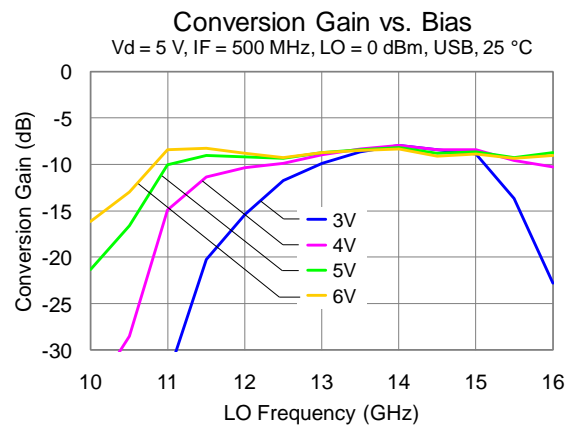
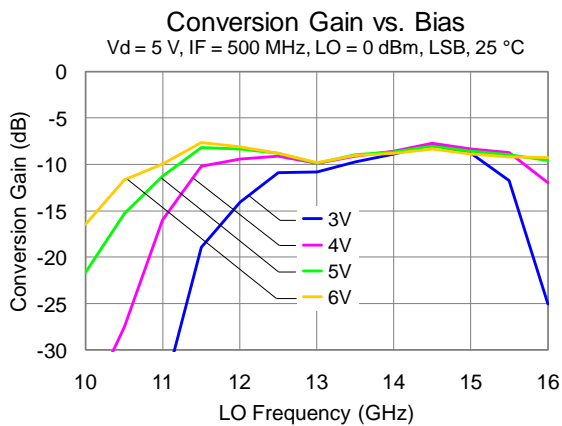
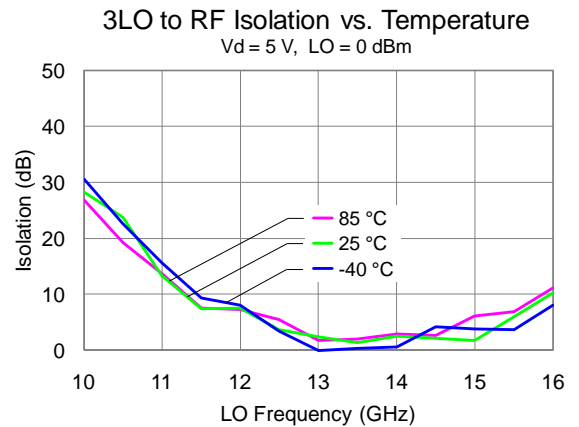
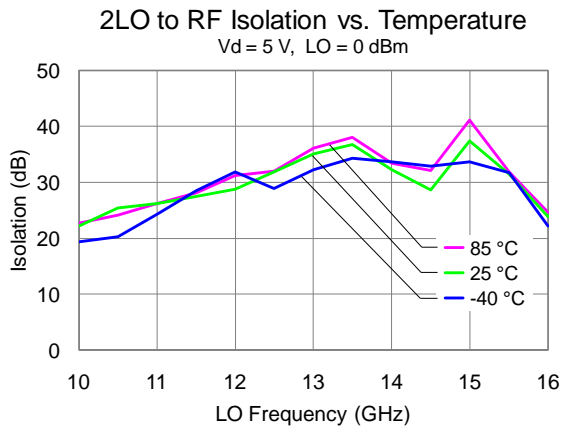
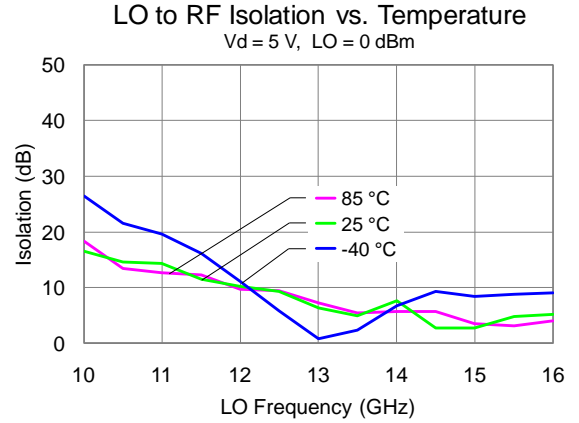
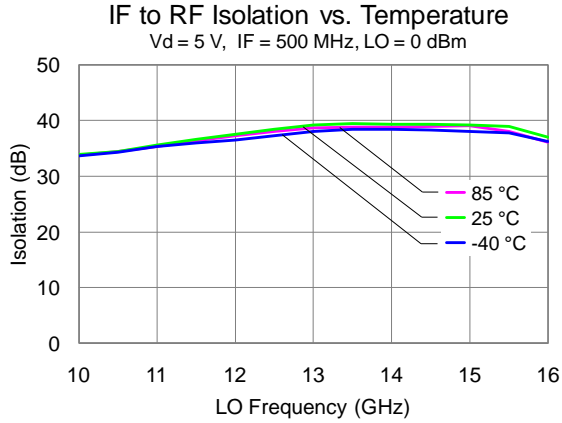

Performance Plots

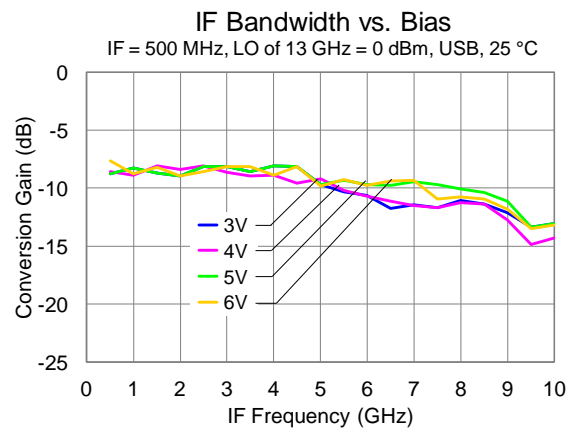
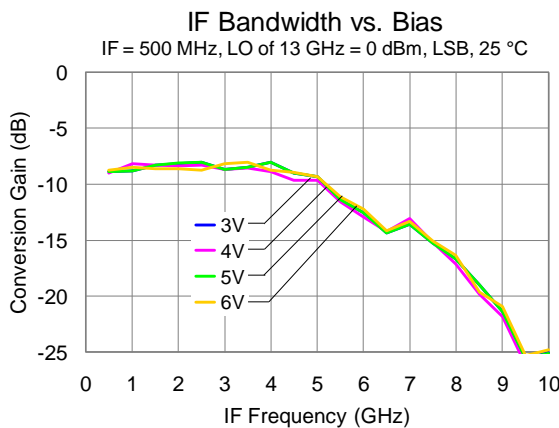
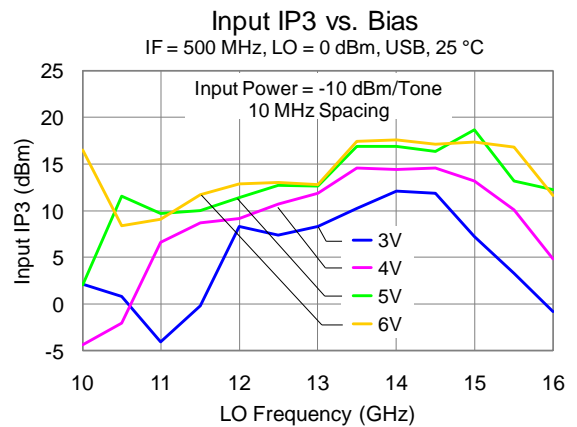
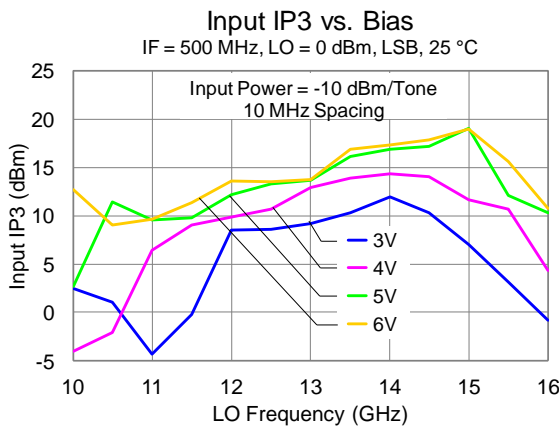
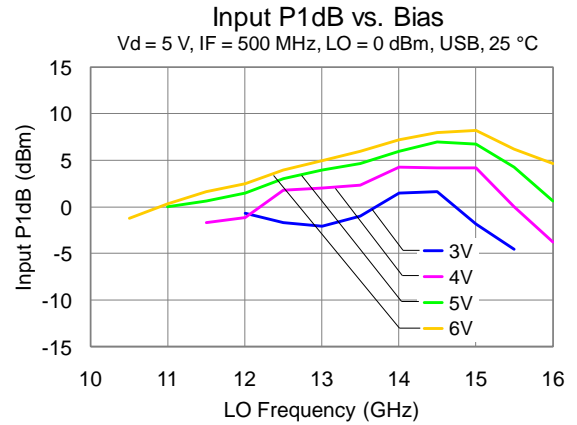
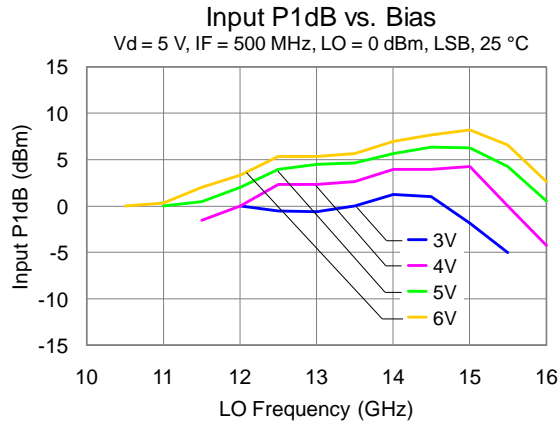

Performance Plots

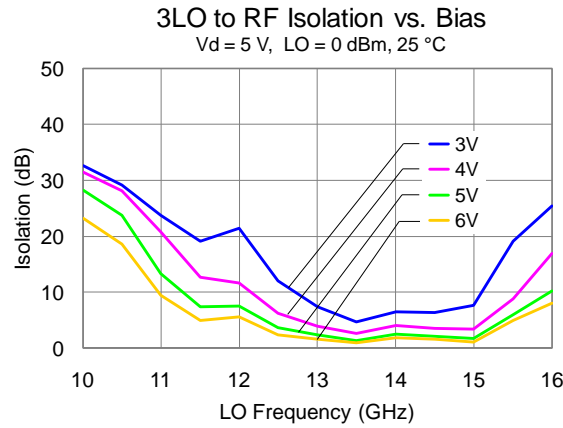
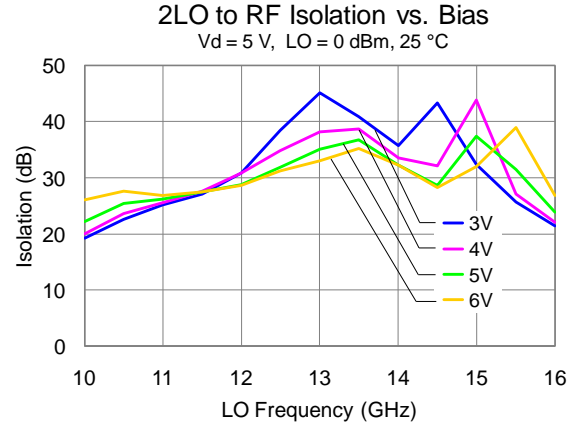
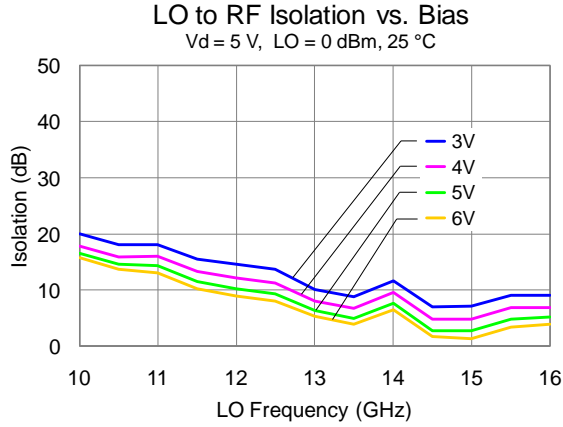

M x N Spurious Outputs

LO at 13 GHz and 0 dBm; IF at 1 GHz and -10 dBm; Vd = 5 V; 25 °C; All values are in dBc from USB.

	nLO			
mRF	3	2	1	0
-2	-32	-39	-53	-59
-1	-35	-1	-40	-24
0	18	-16	12	
1	-35	0	-35	
2	-29	-43	-42	
3		-49	-75	

Pin Configuration and Description

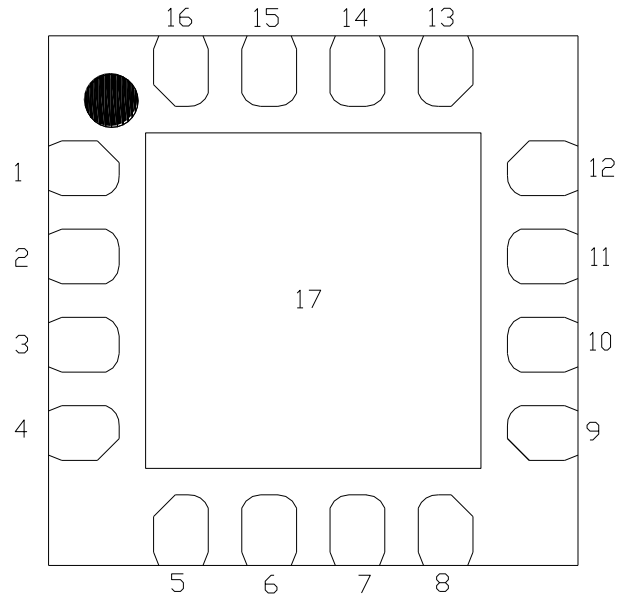

Pin No.	Label	Description
1, 5, 12, 13, 15, 16	N/C	No internal connection; must be grounded on PCB.
2, 4, 6, 8, 9, 11	GND	Internal grounding; must be grounded on PCB.
3	LO IN	Local Oscillator Input, matched to 50 ohms, AC Coupled.
7	IF IN	IF Input matched to 50 ohms, DC Coupled.
10	RF OUT	RF Output matched to 50 ohms, AC Coupled.
14	Vd	Drain voltage. Bias network is required; see Application Circuit on page 11 as an example.
17	GND	Backside Paddle. Multiple vias should be employed to minimize inductance and thermal resistance; see Mounting Configuration on page 13 for suggested footprint.

Applications Circuit

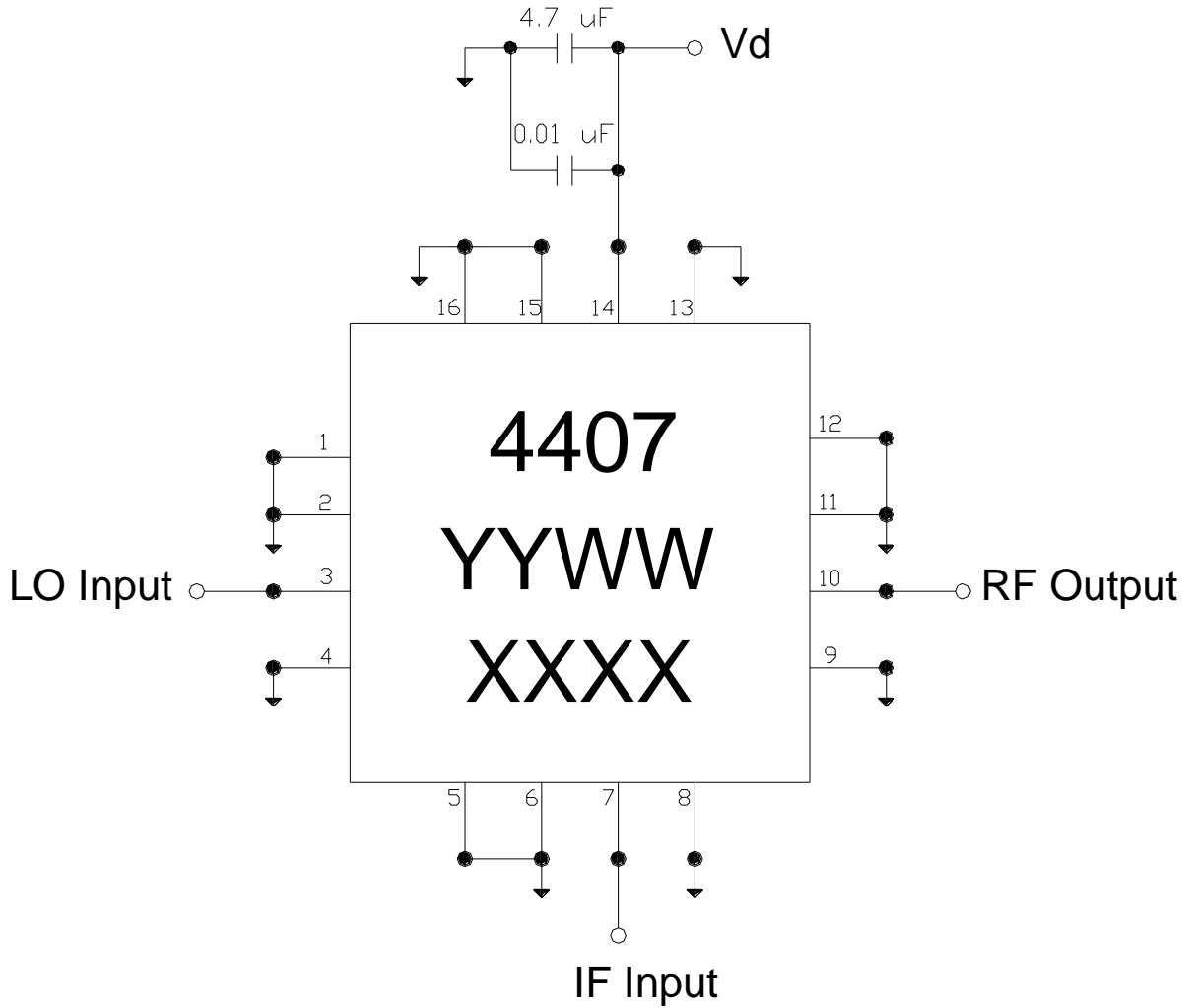

Bias-up Procedure	Bias-down Procedure
Set Id limit to 175 mA	Turn off RF signals
Set Vd to 5 V, Id is typically 65 mA (Self Bias)	Reduce Vd to 0 V
Apply RF signals to LO and IF Inputs	Turn Off Vd

Evaluation Board (EVB) Assembly Layout

Board material is RO4003C 0.012" thickness with ½ oz copper cladding.

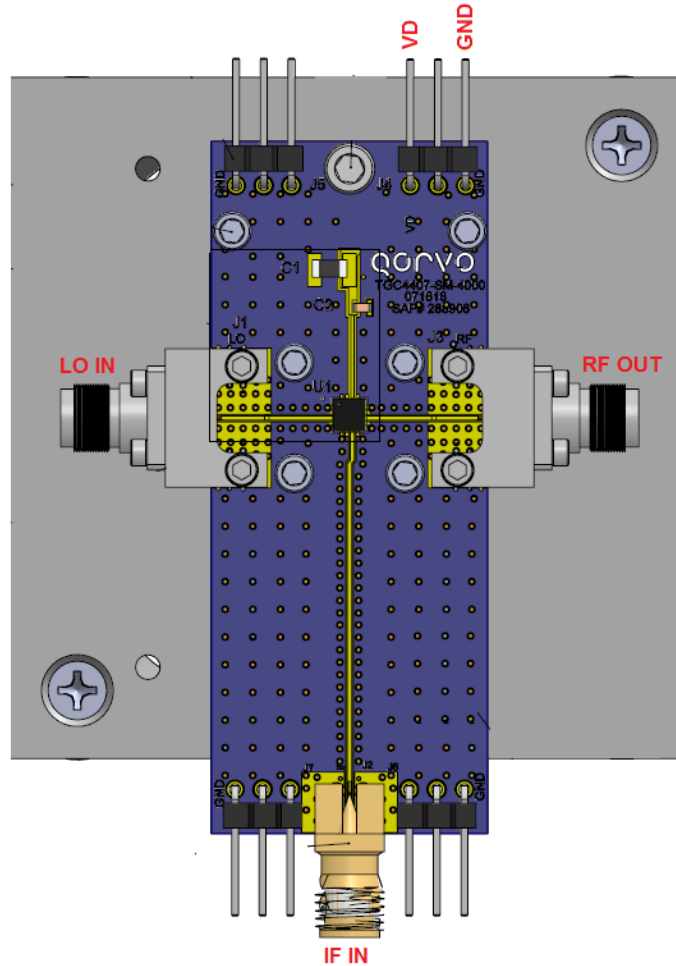

Bill of Material

Ref Des	Value	Description	Manufacturer	Part Number
C1	4.7 µF	Cap, 1206, 50V, 10%, X7R	various	
C2	0.01 µF	Cap, 0603, 25V, 10%, X7R	various	
U1		Ka-Band Up-Converter	Qorvo	TGC4407-SM

Package Marking and Dimensions

All dimensions are in millimeters.

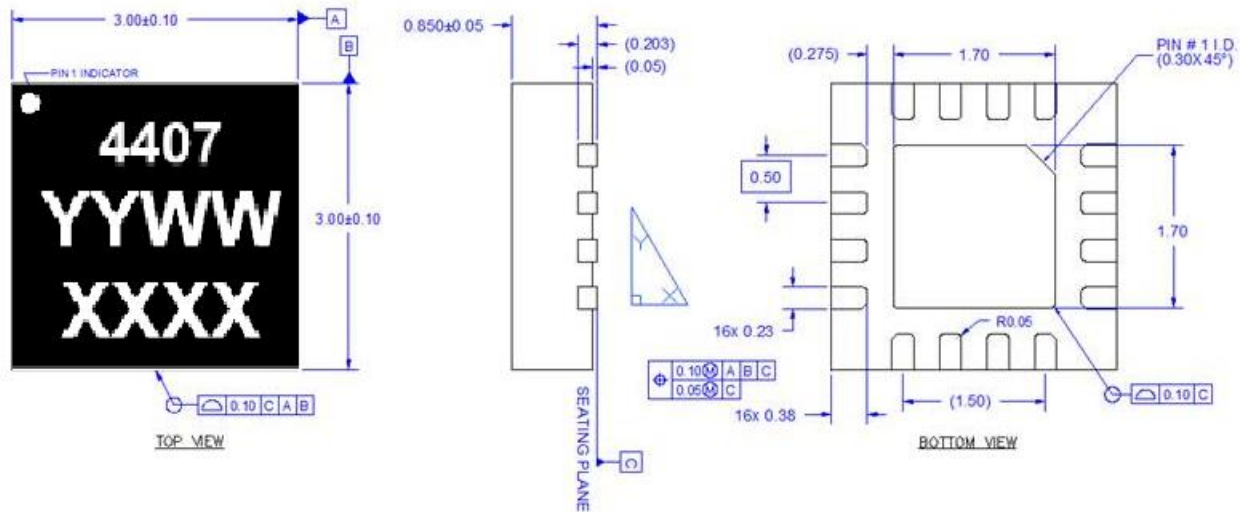

This package is lead-free/RoHS-compliant with a copper alloy base (CDA194), and the plating material on the leads is 100% matte Sn. It is compatible with both lead-free (maximum 260 °C reflow temperature) and tin-lead (maximum 245 °C reflow temperature) soldering processes

The TGC4407-SM will be marked with the "4407" designator and a lot code marked below the part designator. The "YY" represents the last two digits of the year the part was manufactured, the "WW" is the work week, and the "XXXX" is an auto generated number.

PCB Mounting Pattern

Notes:

1. The pad pattern shown has been developed and tested for optimized assembly at Qorvo. The PCB land pattern has been developed to accommodate lead and package tolerances. Since surface mount processes vary from company to company, careful process development is recommended.
2. Ground / thermal vias are critical for the proper performance of this device. Vias should use a final plated thru of 0.40 mm diameter.

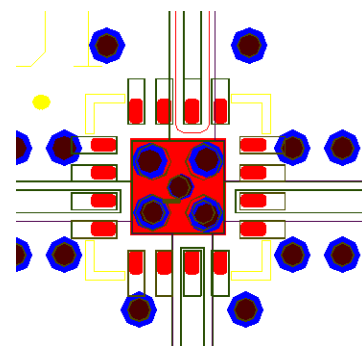

Tape and Reel Information

Standard T/R size = 500 pieces on a 7" reel.

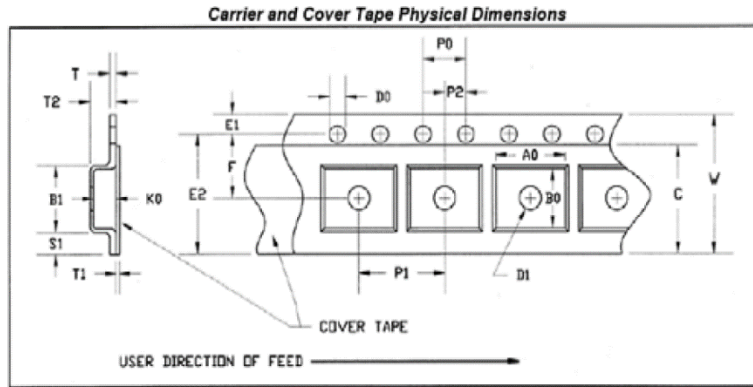

CARRIER AND COVER TAPE DIMENSIONS

Part	Feature	Symbol	Size (in)	Size (mm)
Cavity	Length	A0	0.134	3.4
	Width	B0	0.126	3.2
	Depth	K0	0.055	1.4
	Pitch	P1	0.315	8.0
Distance Between Centerline	Cavity to Perforation Length Direction	P2	0.079	2.0
	Cavity to Perforation Width Direction	F	0.217	5.5
Cover Tape	Width	C	0.374	9.5
Carrier Tape	Width	W	0.472	12.0

Solderability

Compatible with both lead-free (260°C max. reflow temp.) and tin/lead (245°C max. reflow temp.) soldering processes.

Recommended Soldering Temperature Profile

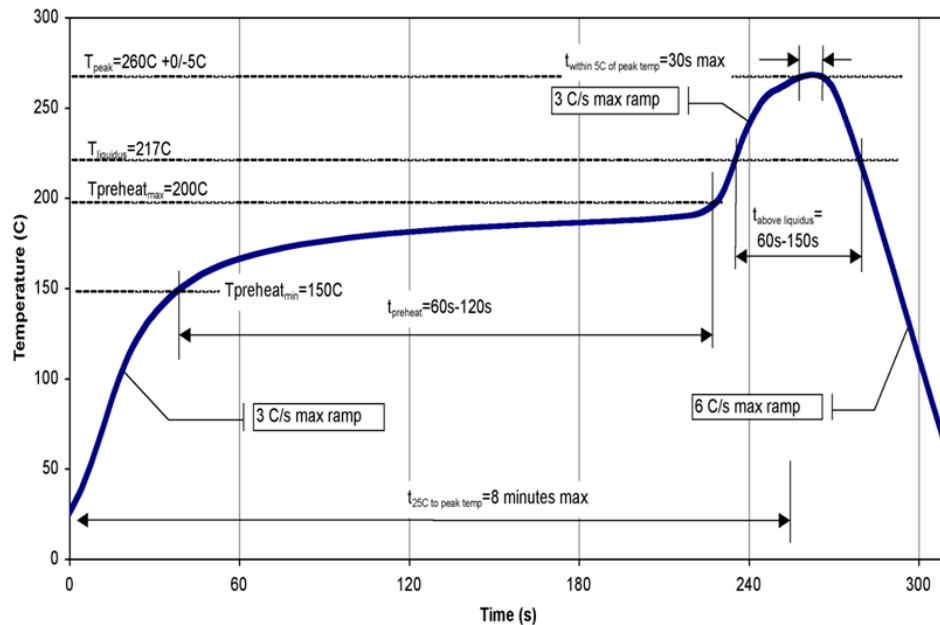

Handling Precautions

Parameter	Rating	Standard
ESD – Human Body Model (HBM)	Class 0	ESDA / JEDEC JS-001-2012
MSL – Moisture Sensitivity Level	Level 1	IPC/JEDEC J-STD-020



Caution!
ESD-Sensitive Device

RoHS Compliance

This product is compliant with the 2011/65/EU RoHS directive (Restrictions on the Use of Certain Hazardous Substances Electrical and Electronic Equipment), as amended by Directive 2015/863/EU. This product also has the following attributes

- Lead Free
- Halogen Free (Chlorine, Bromine)
- Antimony Free
- TBBP-A (C₁₅H₁₂Br₄O₂) Free
- PFOS Free
- SVHC Free

Contact Information

For the latest specifications, additional product information, worldwide sales and distribution locations:

Tel: 1-844-890-8163

Web: www.qorvo.com

Email: customer.support@qorvo.com

For technical questions and application information: **Email:** appsupport@qorvo.com

Important Notice

The information contained herein is believed to be reliable; however, Qorvo makes no warranties regarding the information contained here and assumes no responsibility or liability whatsoever for the use of the information contained herein. All information contained herein is subject to change without notice. Customers should obtain and verify the latest relevant information before placing orders for Qorvo products. The information contained herein or any use of such information does not grant, explicitly or implicitly, to any party any patent rights, licenses or any other intellectual property rights, whether with regard to such information itself or anything described by such information. **THIS INFORMATION DOES NOT CONSTITUTE A WARRANTY WITH RESPECT TO THE PRODUCTS DESCRIBED HEREIN, AND QORVO HEREBY DISCLAIMS ANY AND ALL WARRANTIES WITH RESPECT TO SUCH PRODUCTS WHETHER EXPRESS OR IMPLIED IN ANY LAW, COURSE OF DEALING, COURSE OF PERFORMANCE, USAGE OF TRADE OR OTHERWISE, INCLUDING THE IMPLIED WARRANTIES OF MERCHANTABILITY AND FITNESS FOR A PARTICULAR PURPOSE.**

Without limiting the generality of the foregoing, Qorvo products are not warranted or authorized for use as critical components in medical life-saving, or life-sustaining applications, or other applications where a failure would reasonably be expected to cause severe personal injury or death.

Copyright 2018 © Qorvo, Inc. | Qorvo is a registered trademark of Qorvo, Inc.



Компания «ЭлектроПласт» предлагает заключение долгосрочных отношений при поставках импортных электронных компонентов на взаимовыгодных условиях!

Наши преимущества:

- Оперативные поставки широкого спектра электронных компонентов отечественного и импортного производства напрямую от производителей и с крупнейших мировых складов;
- Поставка более 17-ти миллионов наименований электронных компонентов;
- Поставка сложных, дефицитных, либо снятых с производства позиций;
- Оперативные сроки поставки под заказ (от 5 рабочих дней);
- Экспресс доставка в любую точку России;
- Техническая поддержка проекта, помощь в подборе аналогов, поставка прототипов;
- Система менеджмента качества сертифицирована по Международному стандарту ISO 9001;
- Лицензия ФСБ на осуществление работ с использованием сведений, составляющих государственную тайну;
- Поставка специализированных компонентов (Xilinx, Altera, Analog Devices, Intersil, Interpoint, Microsemi, Aeroflex, Peregrine, Syfer, Eurofarad, Texas Instrument, Miteq, Cobham, E2V, MA-COM, Hittite, Mini-Circuits, General Dynamics и др.);

Помимо этого, одним из направлений компании «ЭлектроПласт» является направление «Источники питания». Мы предлагаем Вам помощь Конструкторского отдела:

- Подбор оптимального решения, техническое обоснование при выборе компонента;
- Подбор аналогов;
- Консультации по применению компонента;
- Поставка образцов и прототипов;
- Техническая поддержка проекта;
- Защита от снятия компонента с производства.



Как с нами связаться

Телефон: 8 (812) 309 58 32 (многоканальный)

Факс: 8 (812) 320-02-42

Электронная почта: org@eplast1.ru

Адрес: 198099, г. Санкт-Петербург, ул. Калинина, дом 2, корпус 4, литера А.