

C106 Series



Description

Glassivated PNP devices designed for high volume consumer applications such as temperature, light, and speed control; process and remote control, and warning systems where reliability of operation is important.

Features

- Glassivated Surface for Reliability and Uniformity
- Power Rated at Economical Prices
- Practical Level Triggering and Holding Characteristics
- Flat, Rugged, Thermopad Construction for Low Thermal Resistance, High Heat Dissipation and Durability
- Sensitive Gate Triggering
- These are Pb-Free Devices

Pin Out

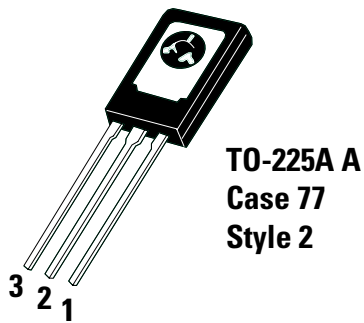

Functional Diagram



Additional Information



Datasheet



Resources



Samples

Maximum Ratings ($T_J = 25^\circ\text{C}$ unless otherwise noted)

| Rating | Symbol | Value | Unit |
|---|--------------------------|-------------------|---------|
| Peak Repetitive Off-State Voltage (Sine Wave, 50–60 Hz, RGK = 1 K, TC = -40° to 110°C) | V_{DRM}^* V_{RRM} | 200 400 600 | V |
| On-State RMS Current (180° Conduction Angles, TC = 80°C) | I_T (RMS) | 4.0 | A |
| Average On-State Current (180° Conduction Angles, $T_c = 80^\circ\text{C}$) | $I_{T(AV)}$ | 2.55 | A |
| Peak Non-Repetitive Surge Current (1/2 Cycle, Sine Wave, 60 Hz, $T_J = +25^\circ\text{C}$) | I_{TSM} | 20 | A |
| Circuit Fusing Considerations ($t = 8.3$ ms) | I^2t | 1.65 | A2s |
| Forward Peak Gate Current (Pulse Width 1.0 sec, TC = 80°C) | I_{GM} | 0.2 | A |
| Forward Peak Gate Power (Pulse Width ≤ 1.0 μsec , $T_c = 80^\circ\text{C}$) | P_{GM} | 0.5 | W |
| Forward Average Gate Power (Pulse Width ≤ 1.0 μsec , $T_c = 80^\circ\text{C}$) | $P_{G(AV)}$ | 0.1 | W |
| Operating Junction Temperature Range | T_J | -40 to +110 | °C |
| Storage Temperature Range | T_{stg} | -40 to +150 | °C |
| Mounting Torque (Note 2) | – | 6.0 | in. lb. |

Stresses exceeding Maximum Ratings may damage the device. Maximum Ratings are stress ratings only. Functional operation above the Recommended Operating Conditions is not implied. Extended exposure to stresses above the Recommended Operating Conditions may affect device reliability.

- V_{DRM} and V_{RRM} for all types can be applied on a continuous basis. Ratings apply for zero or negative gate voltage; however, positive gate voltage shall not be applied concurrent with negative potential on the anode. Blocking voltages shall not be tested with a constant current source such that the voltage ratings of the devices are exceeded.
- Torque rating applies with use of torque washer (Shakeproof WD19523 or equivalent). Mounting Torque in excess of 6 in. lb. does not appreciably lower case-to-sink thermal resistance. Main terminal 2 and heat-sink contact pad are common.

Thermal Characteristics

| Rating | Symbol | Value | Unit |
|--|------------------------------------|-----------|------|
| Thermal Resistance, Junction-to-Case (AC) Junction-to-Ambient | $R_{\theta JC}$ $R_{\theta JA}$ | 3.0 75 | °C/W |
| Maximum Lead Temperature for Soldering Purposes, 1/8" from case for 10 seconds | T_L | 260 | °C |

Electrical Characteristics - OFF ($T_J = 25^\circ\text{C}$ unless otherwise noted)

| Characteristic | Symbol | Min | Typ | Max | Unit | |
|--|-----------------------|---------------------------|-----|-----|------|---------------|
| Peak Repetitive Forward or Reverse Blocking Current ($V_{AK} = \text{Rated } V_{DRM} \text{ or } V_{RRM}$, $R_{GK} = 1 \text{ k}\Omega$) | I_{DRM}^* I_{RRM} | $T_J = 25^\circ\text{C}$ | – | – | 10 | μA |
| | | $T_J = 110^\circ\text{C}$ | – | – | 100 | μA |

Electrical Characteristics - ON ($T_J = 25^\circ\text{C}$ unless otherwise noted)

| Characteristic | Symbol | Min | Typ | Max | Unit | |
|--|-----------|----------------------------|-----|------|------|---------------|
| Peak Forward On-State Voltage (Note 3) ($I_{TM} = 4$ A) | V_{TM} | – | – | 2.2 | V | |
| Gate Trigger Current (Continuous dc) ($V_D = 12$ V, $R_L = 100 \Omega$, All Quadrants) | I_{GT} | $T_J = 25^\circ\text{C}$ | – | 15 | 200 | μA |
| | | $T_J = -40^\circ\text{C}$ | – | 35 | 500 | μA |
| Peak Reverse Gate Voltage ($I_{GR} = 10 \mu\text{A}$) | V_{GRM} | – | – | 6.0 | V | |
| Gate Trigger Voltage (Continuous dc) ($V_D = 12$ Vdc, $R_L = 100 \Omega$, $T_c = 25^\circ\text{C}$) | V_{GT} | $T_J = 25^\circ\text{C}$ | 0.4 | 0.60 | 0.8 | V |
| | | $T_J = -40^\circ\text{C}$ | 0.5 | 0.75 | 1.0 | V |
| Gate Non-Trigger Voltage (Continuous dc) (Note 4) ($V_{AK} = 12$ V, $R_L = 100$ ($V_{AK} = 12$ V, $R_L = 100$, $T_J = 110^\circ\text{C}$), $T_J = 110^\circ\text{C}$) | V_{GD} | 0.2 | – | – | V | |
| Latching Current ($V_{AK} = 12$ V, $I_G = 20$ mA, $R_{GK} = 1 \text{ k}\Omega$) | I_L | $T_J = 25^\circ\text{C}$ | – | 0.20 | 5.0 | mA |
| | | $T_J = -40^\circ\text{C}$ | – | 0.35 | 7.0 | mA |
| Holding Current ($V_D = 12$ Vdc) (Initiating Current = 20 mA, $R_{GK} = 1 \text{ k}\Omega$) | I_H | $T_J = 25^\circ\text{C}$ | – | 0.19 | 3.0 | mA |
| | | $T_J = -40^\circ\text{C}$ | – | 0.33 | 6.0 | mA |
| | | $T_J = +110^\circ\text{C}$ | – | 0.07 | 2.0 | mA |

Dynamic Characteristics

| Characteristic | Symbol | Min | Typ | Max | Unit |
|---|--------|-----|-----|-----|------------|
| Critical Rate-of-Rise of Off State Voltage (V_{AK} = Rated V_{DRM} , Exponential Waveform, $R_{GK} = 1k\Omega, T_J = 110^\circ C$) | dv/dt | - | 8.0 | - | V/ μs |

- 3. Pulse Test: Pulse Width ≤ 2.0 ms, Duty Cycle $\leq 2\%$.
- 4. R_{GK} is not included in measurement.

Voltage Current Characteristic of SCR

| Symbol | Parameter |
|-----------|---|
| V_{DRM} | Peak Repetitive Forward Off State Voltage |
| I_{DRM} | Peak Forward Blocking Current |
| V_{RRM} | Peak Repetitive Reverse Off State Voltage |
| I_{RRM} | Peak Reverse Blocking Current |
| V_{TM} | Maximum On State Voltage |
| I_H | Holding Current |

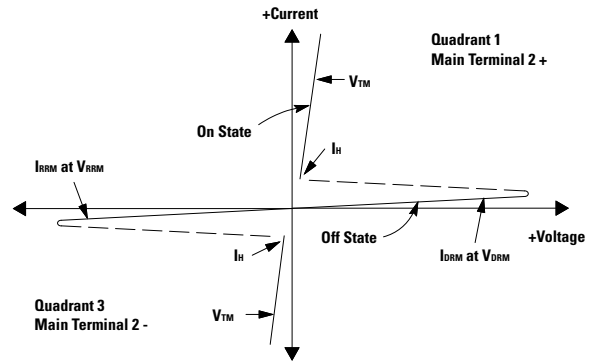

Figure 1. Average Current Derating

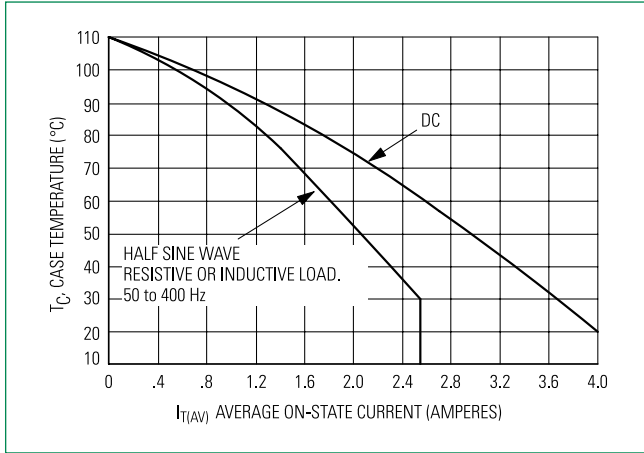

Figure 2. Maximum On-State Power Dissipation

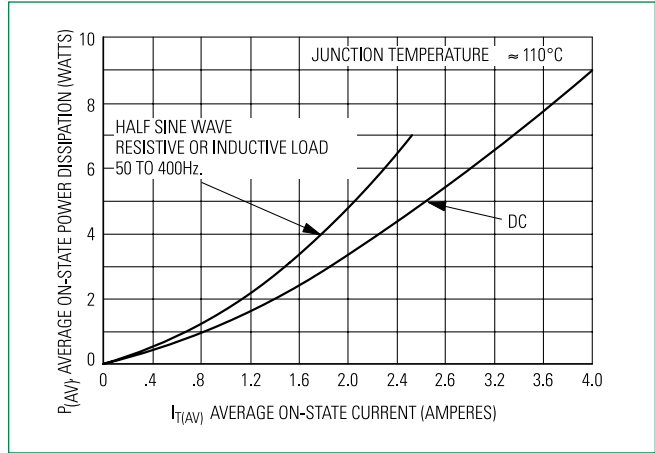

Figure 3. Typical Gate Trigger Current vs. Junction Temp

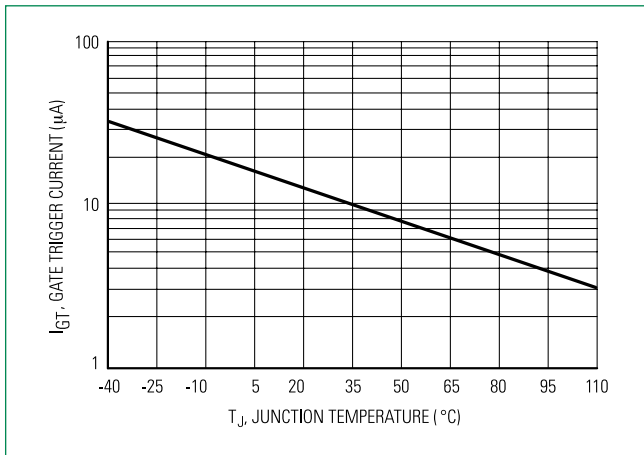

Figure 4. Typical Holding Current vs. Junction Temp

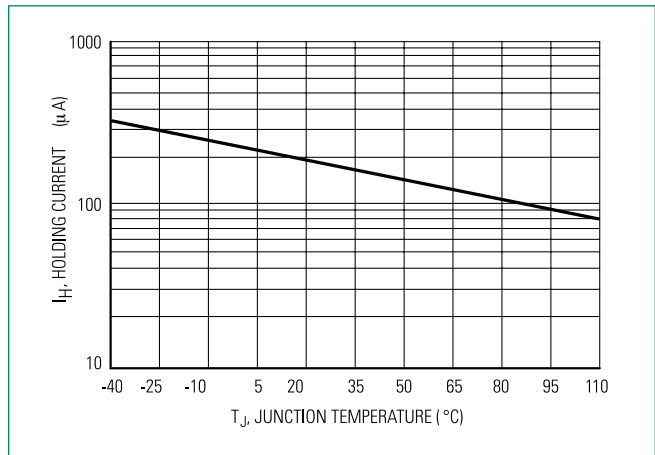

Figure 5. Typical Gate Trigger Voltage vs. Junction Temp

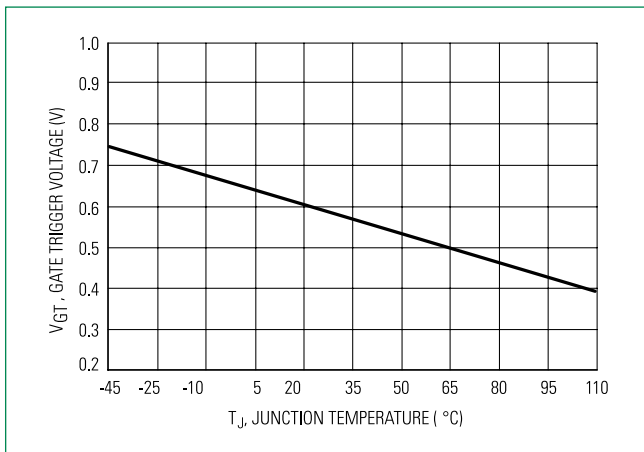
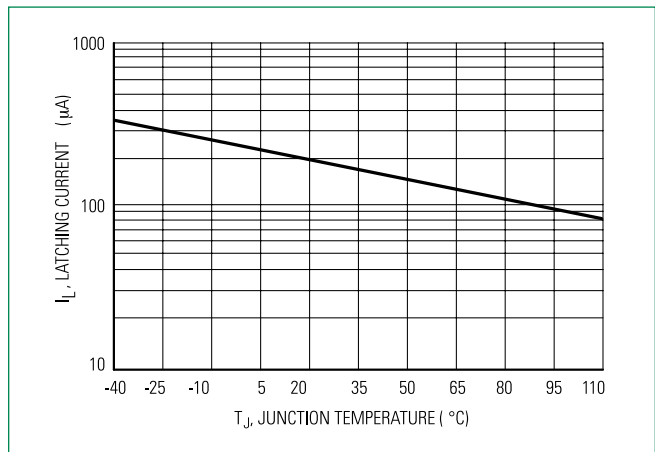
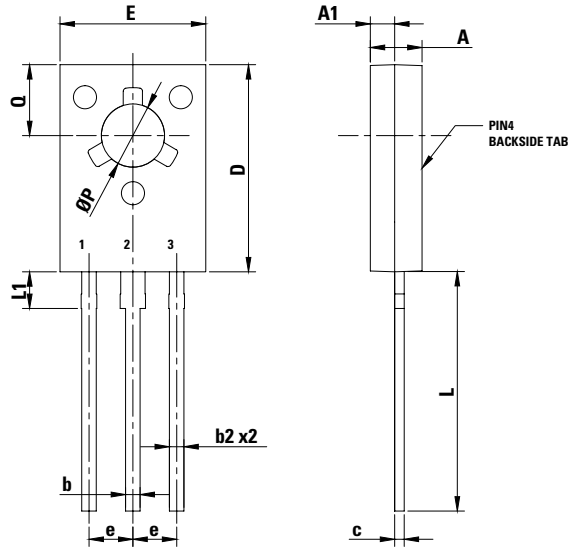

Figure 5. Typical Latching Current vs. Junction Temp



Dimensions



Part Marking System

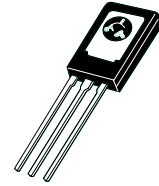

TO-225A A
Case 07 7
Style 2

- 1. Cathode
- 2. Anode
- 3. Gate

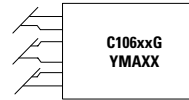

- Y =Year
- M =Month
- A =Assembly Site
- XX =Lot Serial Code
- C106xx =Device Code
- xx =B, D, D1, M, M1
- G =Pb-Free Package

| Dim | Inches | | Millimeters | |
|-----|-----------|-------|-------------|-------|
| | Min | Max | Min | Max |
| A | 0.102 | 0.110 | 2.60 | 2.80 |
| A1 | 0.047 | 0.055 | 1.20 | 1.40 |
| b | 0.028 | 0.034 | 0.70 | 0.86 |
| b2 | 0.028 | 0.034 | 0.70 | 0.86 |
| c | 0.019 | 0.022 | 0.49 | 0.57 |
| D | 0.417 | 0.449 | 10.60 | 11.40 |
| E | 0.291 | 0.323 | 7.40 | 8.20 |
| e | 0.090 TYP | | 2.29 TYP | |
| L | 0.551 | 0.630 | 14.00 | 16.00 |
| L1 | 0.091 | 0.106 | 2.30 | 2.70 |
| P | 0.118 | 0.134 | 3.00 | 3.40 |
| Q | 0.142 | 0.157 | 3.60 | 4.00 |

1. DIMENSIONING AND TOLERANCING PER ANSI Y14.5M, 1982.
2. CONTROLLING DIMENSION: INCH.
3. 077-01 THRU -08 OBSOLETE, NEW STANDARD 077-09.

| Pin Assignment | |
|----------------|---------|
| 1 | Cathode |
| 2 | Anode |
| 3 | Gate |

Ordering Information

| Device | Package | Shipping |
|----------|----------------------|---------------------------------|
| C106BG | TO225AA (Pb-Free) | 2500 Units/Box |
| C106DG | | |
| C106D1G* | | |
| C106MG | | |
| C106M1G* | | |
| C106MTG | | 60 Units/Tube 1920 Units/Box |

*D1 signifies European equivalent for D suffix and M1 signifies European equivalent for M suffix.



Компания «ЭлектроПласт» предлагает заключение долгосрочных отношений при поставках импортных электронных компонентов на взаимовыгодных условиях!

Наши преимущества:

- Оперативные поставки широкого спектра электронных компонентов отечественного и импортного производства напрямую от производителей и с крупнейших мировых складов;
- Поставка более 17-ти миллионов наименований электронных компонентов;
- Поставка сложных, дефицитных, либо снятых с производства позиций;
- Оперативные сроки поставки под заказ (от 5 рабочих дней);
- Экспресс доставка в любую точку России;
- Техническая поддержка проекта, помощь в подборе аналогов, поставка прототипов;
- Система менеджмента качества сертифицирована по Международному стандарту ISO 9001;
- Лицензия ФСБ на осуществление работ с использованием сведений, составляющих государственную тайну;
- Поставка специализированных компонентов (Xilinx, Altera, Analog Devices, Intersil, Interpoint, Microsemi, Aeroflex, Peregrine, Syfer, Eurofarad, Texas Instrument, Miteq, Cobham, E2V, MA-COM, Hittite, Mini-Circuits, General Dynamics и др.);

Помимо этого, одним из направлений компании «ЭлектроПласт» является направление «Источники питания». Мы предлагаем Вам помощь Конструкторского отдела:

- Подбор оптимального решения, техническое обоснование при выборе компонента;
- Подбор аналогов;
- Консультации по применению компонента;
- Поставка образцов и прототипов;
- Техническая поддержка проекта;
- Защита от снятия компонента с производства.



Как с нами связаться

Телефон: 8 (812) 309 58 32 (многоканальный)

Факс: 8 (812) 320-02-42

Электронная почта: org@eplast1.ru

Адрес: 198099, г. Санкт-Петербург, ул. Калинина, дом 2, корпус 4, литера А.