

### Applications

- Commercial and Military Radar
- Satellite Communications
- General Purpose Switching

### Product Features

- SPDT, Reflective Switch
- Frequency Range: 13 - 19 GHz
- Insertion Loss: < 1.7 dB
- Power Handling: 2 W (P-0.1dB)
- ITOI: 55 dBm (at P<sub>IN</sub>/Tone = 22 dBm)
- Isolation: > 20 dB
- Switching Speed: 20 ns
- Control Voltages: V<sub>DD</sub> = 3.3 - 5 V, V<sub>BIT</sub> = 0/V<sub>DD</sub> V
- Process Technology: GaAs-PHEMTES15-DR
- Package Dimensions: 4.0 x 4.0 x 1.47 mm

### General Description

The TGS4310-SM is a packaged single-pole, double-throw (SPDT) reflective switch operating from 13 to 19 GHz. With an insertion loss of <1.7 dB, the TGS4310-SM supports 2 W of incident power at 0.1 dB compression.

For mechanical robustness and ease of handling, the TGS4310-SM is available in a low-cost, 4x4 mm air-cavity ceramic QFN. Fully matched to 50 ohms at all ports, it uses standard positive control voltages and requires very little control current making system integration simple without impacting DC power budgets.

The TGS4310-SM is ideally suited for a variety of Ku-band switching applications across both defense and commercial applications.

Lead-free and RoHS compliant

Evaluation Boards are available upon request.

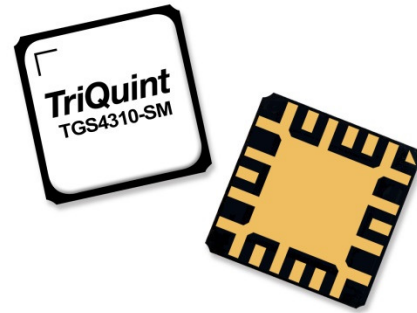

QFN 4x4 mm 22L

### Functional Block Diagram

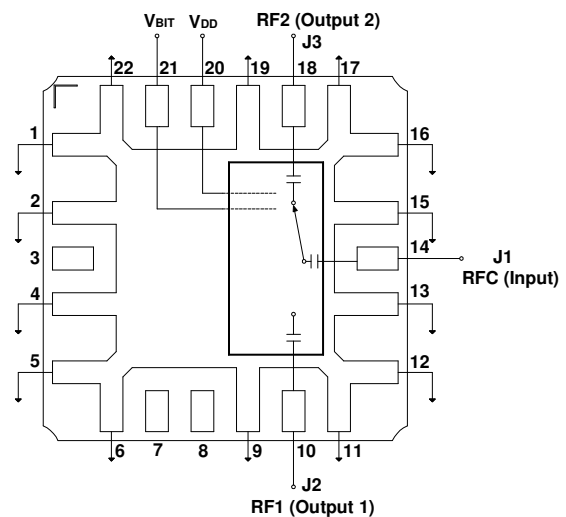

### Pin Configuration

Pad No.	Symbol
1, 2, 4, 5-6, 9, 11-13, 15-17, 19, 22	GND
3, 7, 8	NC
10	RF1
14	RFC
18	RF2
20	V <sub>DD</sub>
21	V <sub>BIT</sub>
23	GND Paddle

### Ordering Information

Part	ECCN	Description
TGS4310-SM	EAR99	13-19GHz 2W SPDT Switch

### Absolute Maximum Ratings

Parameter	Value
Voltages ( $V_{DD}$ , $V_{BIT}$ )	6 V
Currents ( $I_{DD}$ , $I_{BIT}$ )	-1.7 / +1.7 mA
Power Dissipation, $T_{BASE} = 85\text{ }^{\circ}\text{C}$	1.8 W
Input Power ( $P_{IN}$ ), CW/Pulsed, 50 $\Omega$ , 85 $^{\circ}\text{C}$	34 dBm
Input Power ( $P_{IN}$ ), hot switching, 90/10%, 45 ns speed, 50% duty cycle	33 dBm
Channel Temperature ( $T_{CH}$ )	200 $^{\circ}\text{C}$
Mounting Temperature (30 sec)	260 $^{\circ}\text{C}$
Storage Temperature	-55 to 150 $^{\circ}\text{C}$

Operation of this device outside the parameter ranges given above may cause permanent damage. These are stress ratings only, and functional operation of the device at these conditions is not implied.

### Recommended Operating Conditions

Parameter	Min	Typ	Max	Units
Frequency	13		19	GHz
Input Power Handling (CW/Pulsed RF)		$\leq 33$		dBm
Reference Voltage, $V_{DD}$		3.3 - 5		V
Control Voltage, $V_{BIT}$		0/ $V_{DD}$		V
Currents ( $I_{DD}$ , $I_{BIT}$ )	See plots p. 7			
Operating Temperature	-40		+85	$^{\circ}\text{C}$

Electrical specifications are measured at specified test conditions. Specifications are not guaranteed over all recommended operating conditions.

### Electrical Specifications

Test conditions unless otherwise noted:  $V_{DD} = 5\text{ V}$ ,  $V_{BIT} = 0/5\text{ V}$ ,  $Temp = +25\text{ }^{\circ}\text{C}$ .  $Z_0 = 50\text{ }\Omega$

Parameter	Min	Typical	Max	Units
Operational Frequency Range	13		19	GHz
Input Power at 0.1 dB Gain Compression (P-0.1dB)		33		dBm
Insertion Loss		< 1.7		dB
Isolation		> 20		dB
Input Return Loss – On-State (Common Port RL)		> 12		dB
Output Return Loss – On-State (Switched Port RL)		> 12		dB
Output Return Loss – Off-State (Isolated Port RL)		< 1		dB
Input TOI at $P_{IN}/Tone = 22\text{ dBm}$ (ITOI)		55		dBm
IM3 at $P_{IN}/Tone = 22\text{ dBm}$		-75		dBc
IM5 at $P_{IN}/Tone = 22\text{ dBm}$		-75		dBc
Insertion Loss Temperature Coefficient		0.003		dB/ $^{\circ}\text{C}$
Switching Speed (90/10%)		20		ns

### Thermal and Reliability Information

Parameter	Test Conditions	Value	Units
Thermal Resistance ( $\theta_{JC}$ ) <sup>(1)</sup>	$T_{BASE} = 85\text{ }^{\circ}\text{C}$ , $V_{DD} = 5\text{ V}$ , $V_{BIT} = 0/5\text{ V}$ , CW, Frequency = 13 GHz, $P_{IN} = 33\text{ dBm}$ (2 W), Insertion Loss = 2 dB, $P_{OUT} = 31\text{ dBm}$ (1.25 W), $P_{DISS} = 0.75\text{ W}$	60	$^{\circ}\text{C/W}$
Channel Temperature ( $T_{CH}$ ) (Under RF drive)		130	$^{\circ}\text{C}$
Median Lifetime ( $T_M$ )		1.1E+7	Hrs

Notes:

1. Thermal resistance measured to back of package.

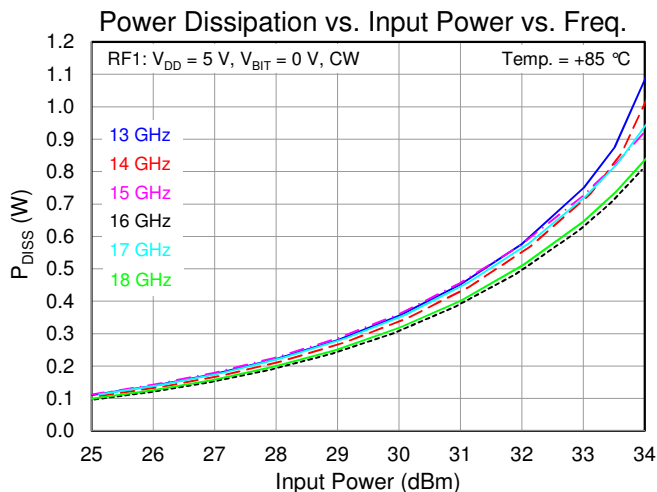

Test Conditions:  $V_D = 7\text{ V}$ ; Failure Criteria = 10% reduction in  $I_{D\_MAX}$

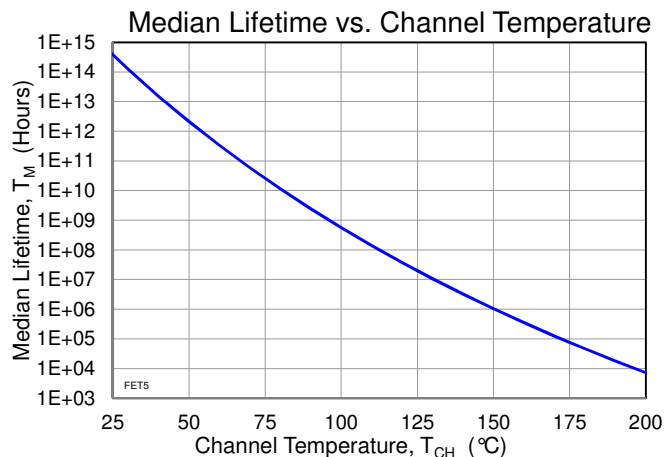

### Typical Performance: Small Signal

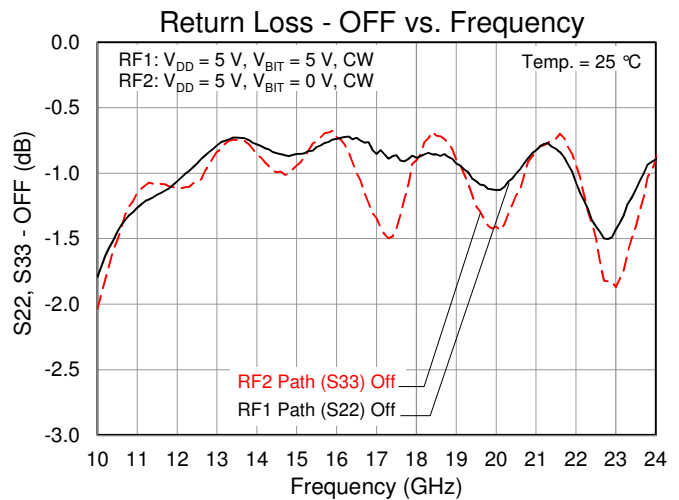
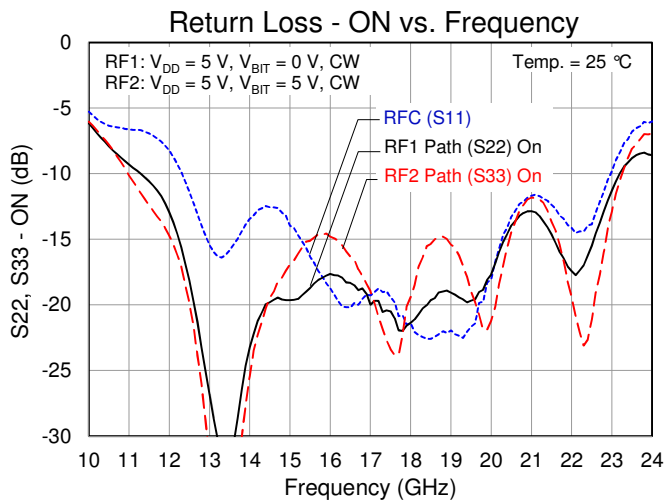
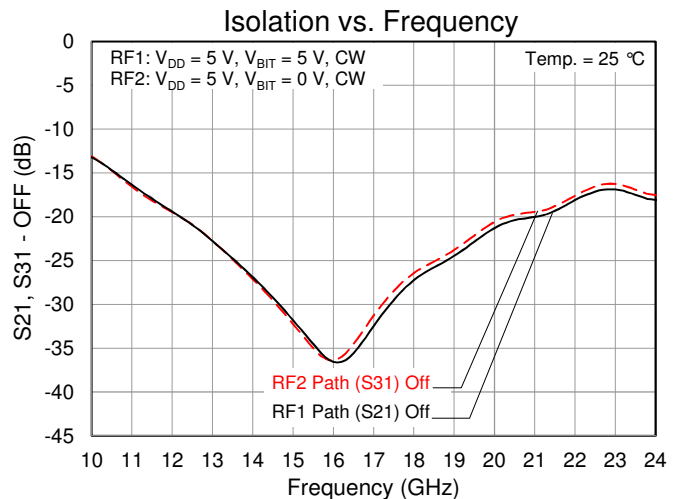
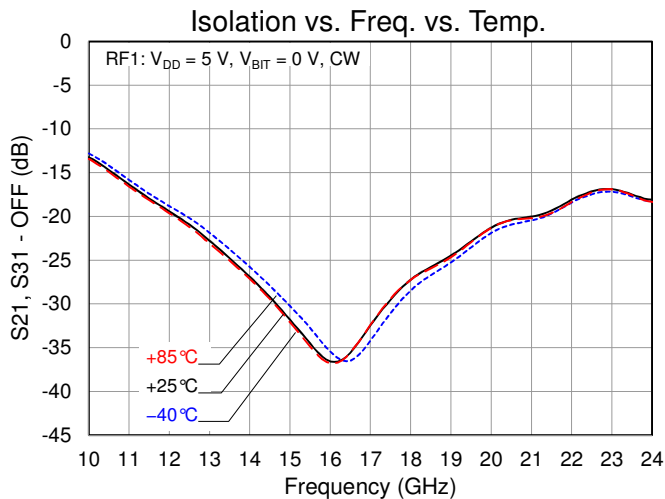
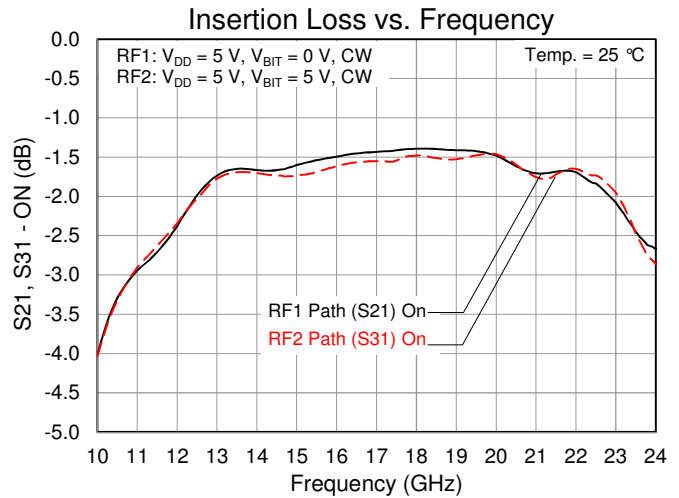
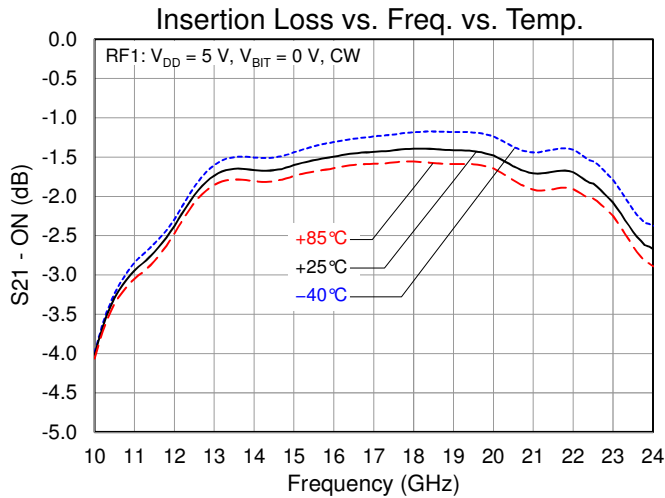

### Typical Performance: Large Signal - CW

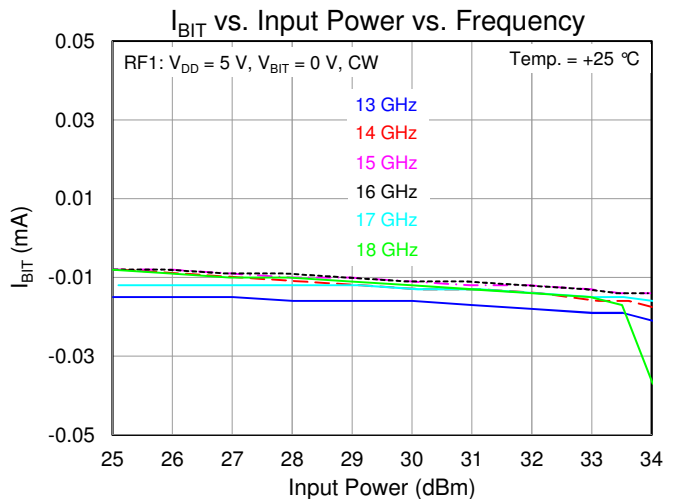
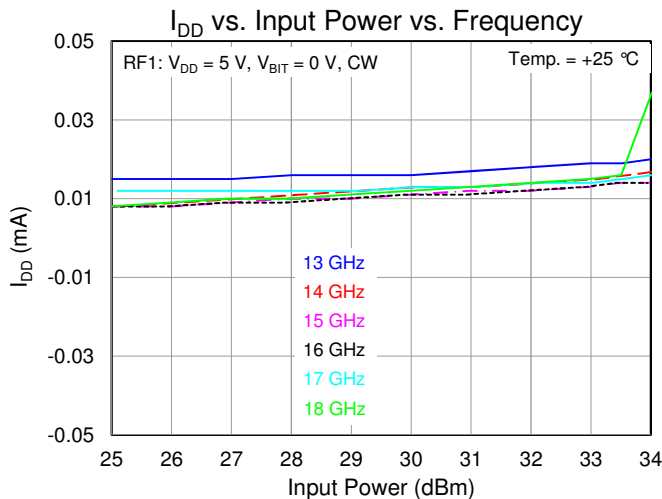
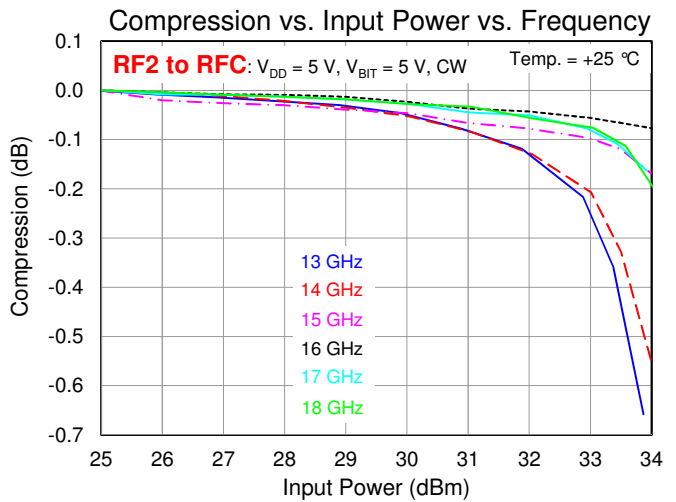
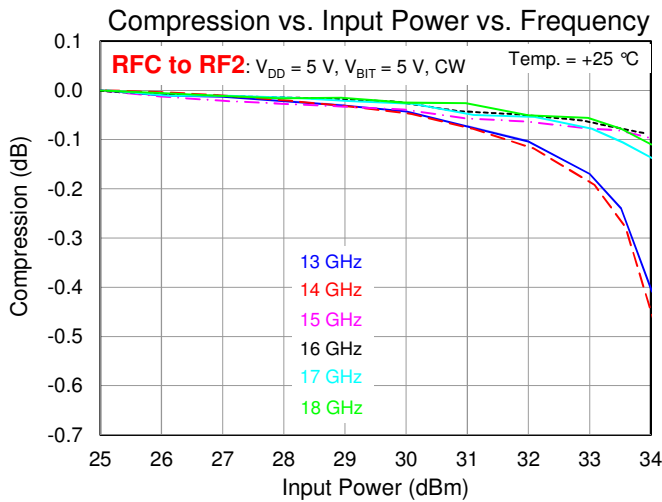
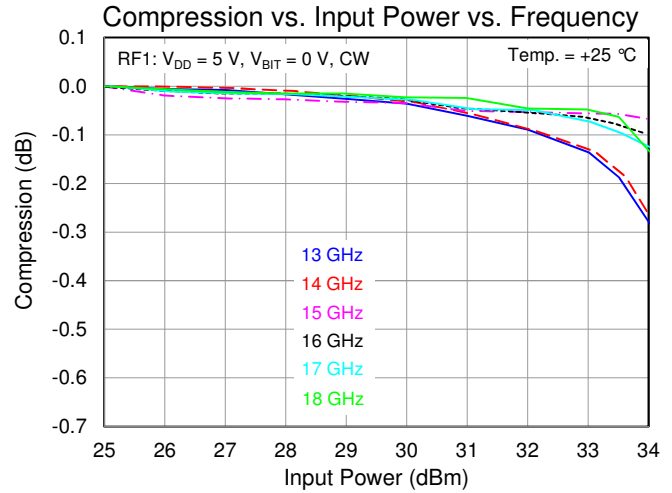
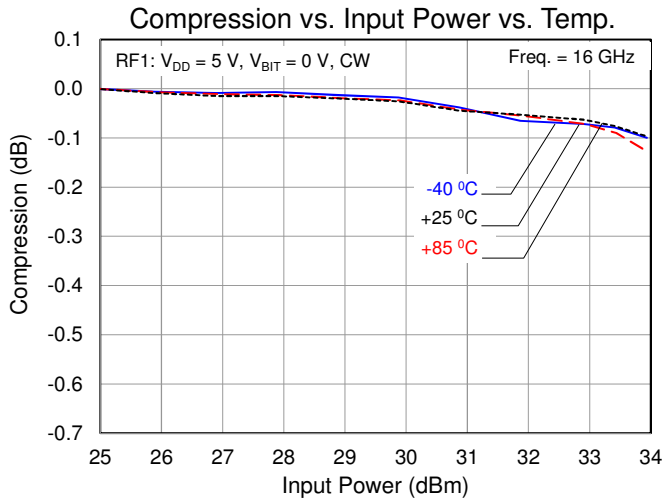

**Typical Performance: Large Signal – Pulsed RF (PW = 10 us, DC = 10 %)**

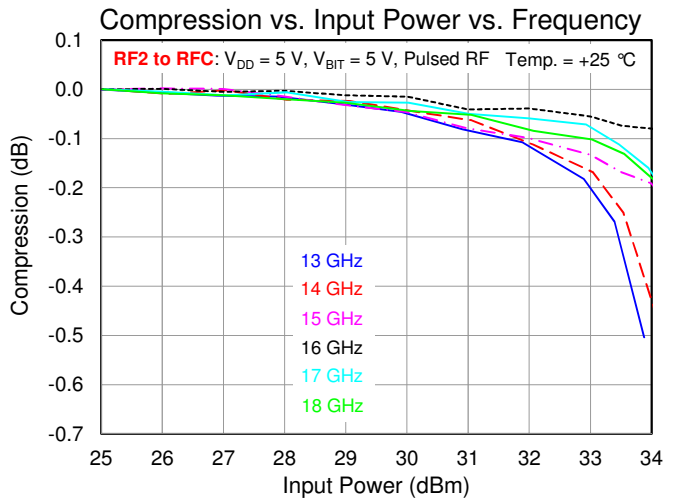
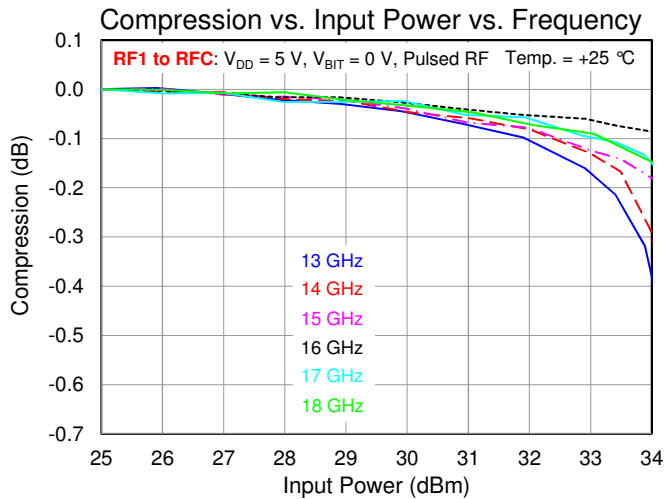
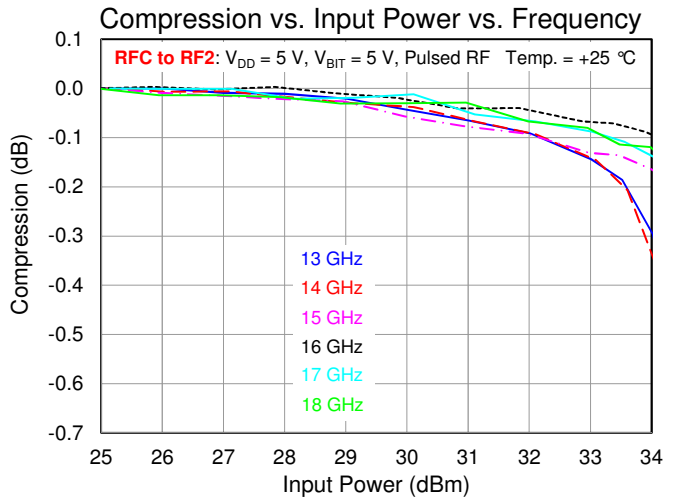
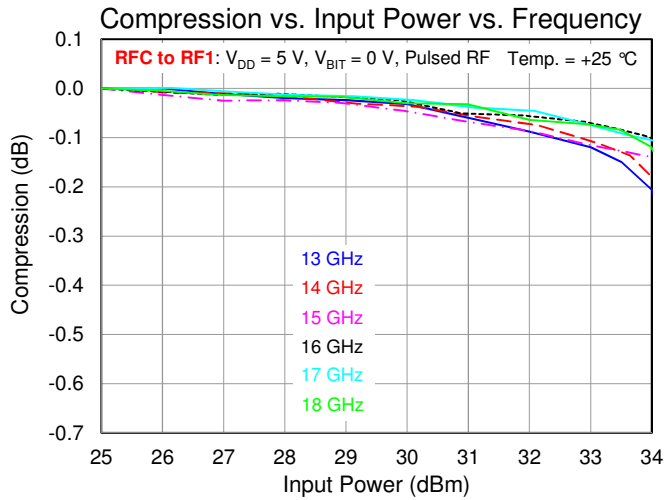

### Typical Performance: Linearity

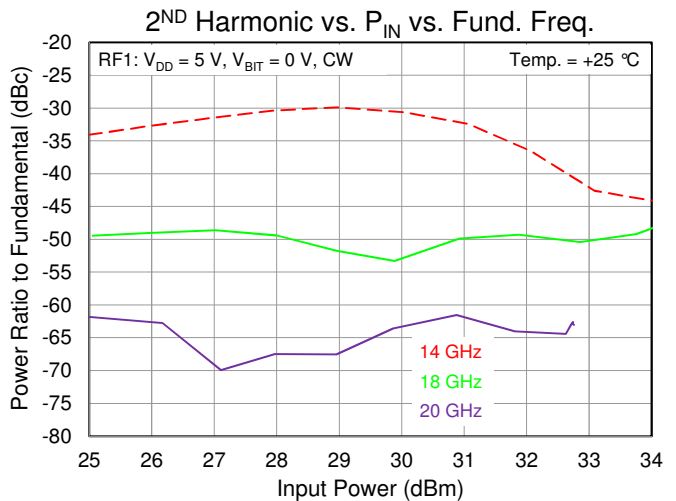
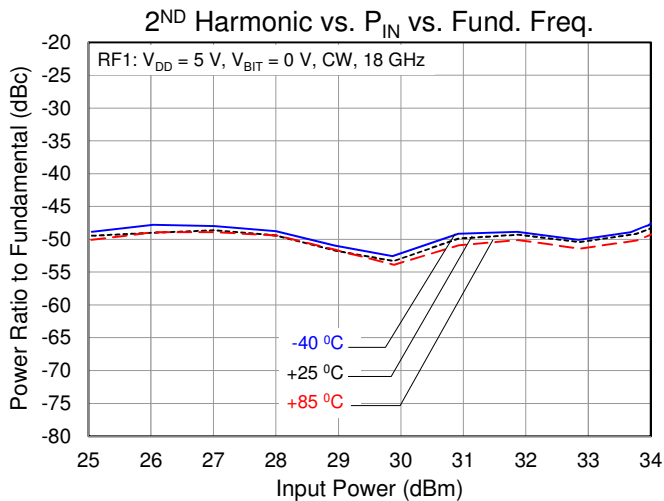
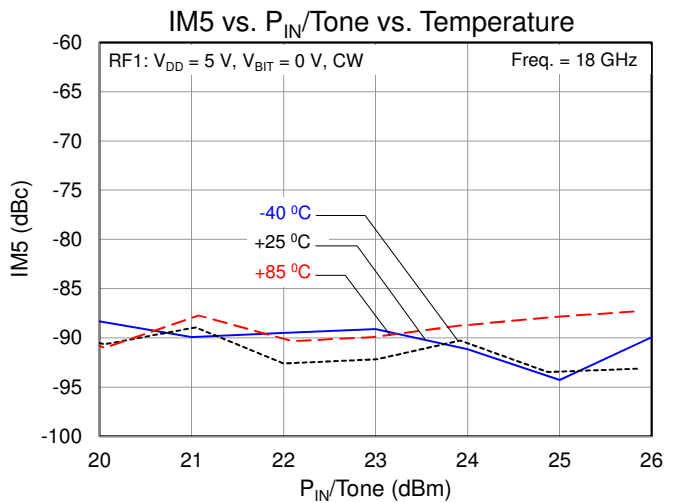
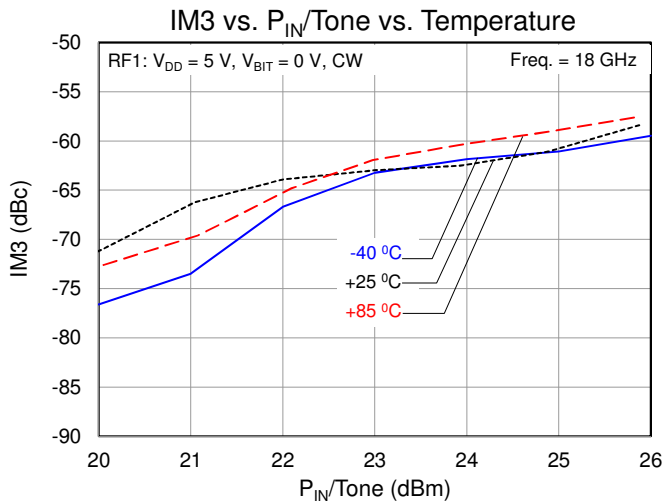
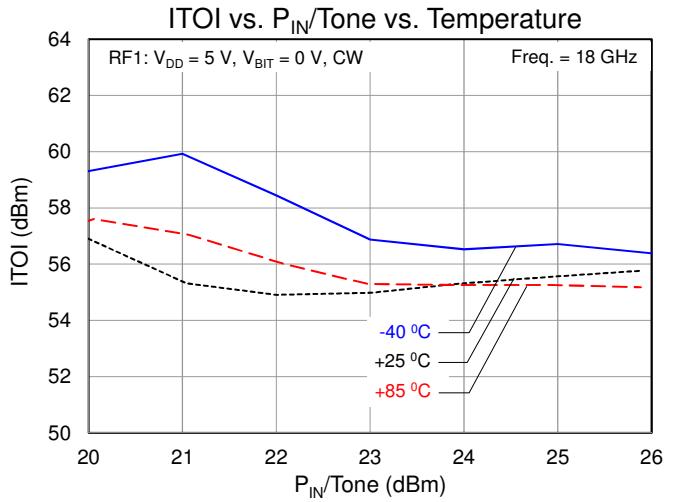
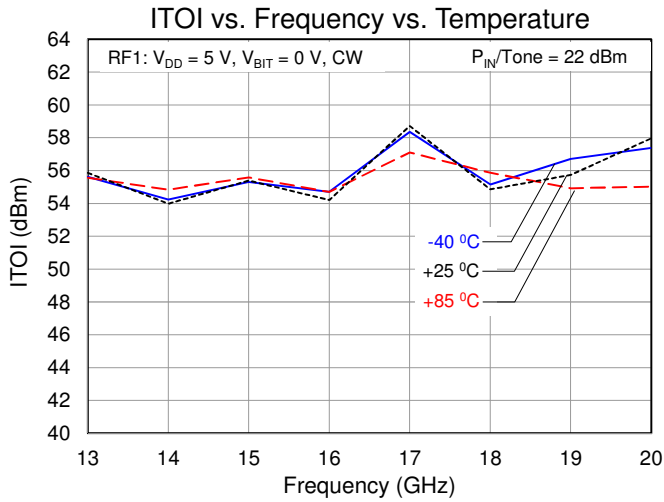

**Typical Performance: Switching Speed**

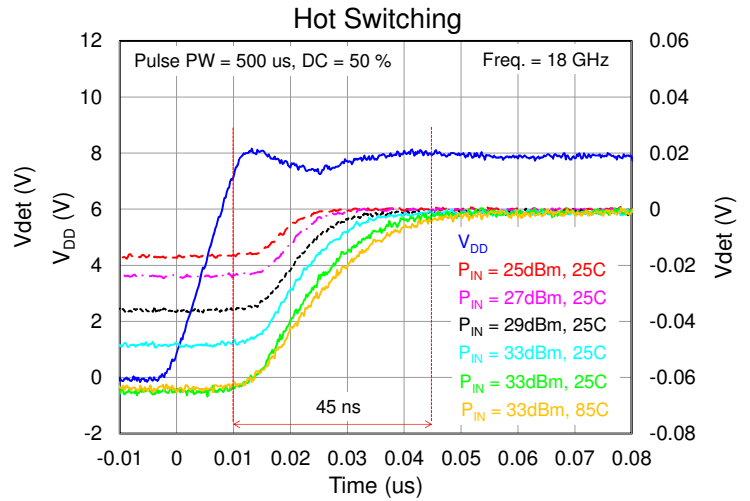
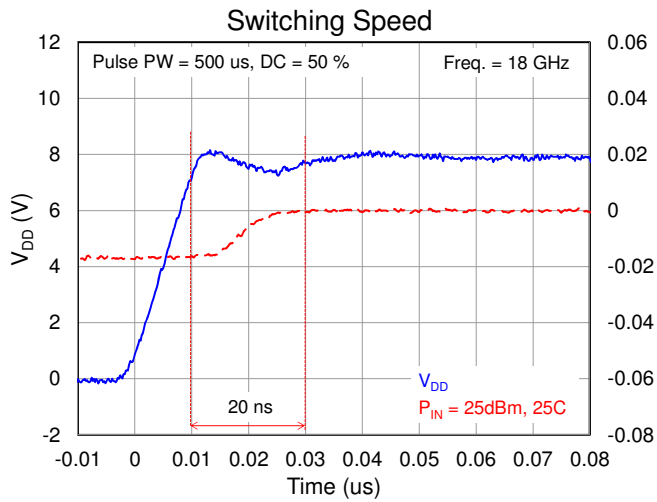



## Applications Information

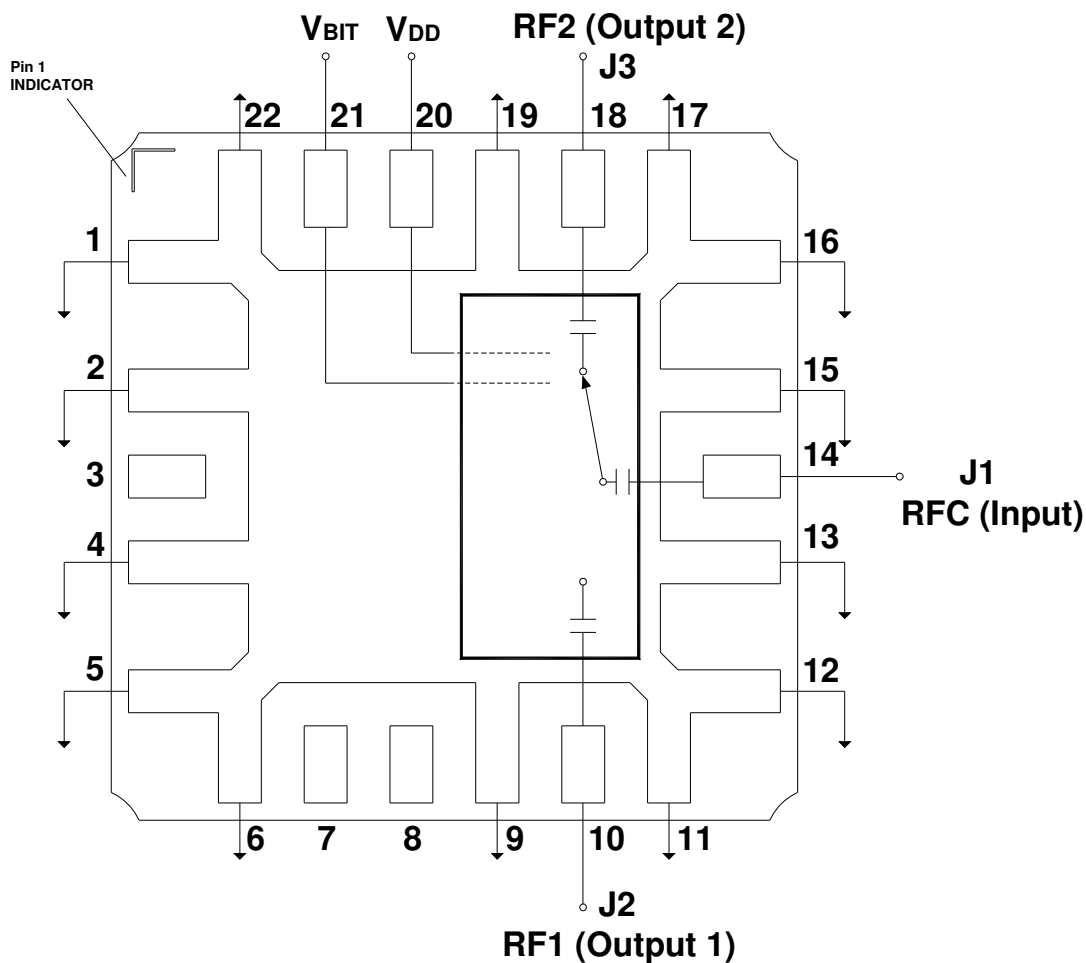

The switch can be configured as a Single Pole, Single Throw (SPST) by terminating one unused RF switched port (pin 10 or pin 18) with a 50 Ohm load.

## Function Table

RF Path	State	V <sub>DD</sub> (V)	V <sub>BIT</sub> (V)
RFC (Input) to RF1 (Output1)	On-State (Insertion Loss)	5	0
	Off-State (Isolation)	5	5
RFC (Input) to RF2 (Output 2)	On-State (Insertion Loss)	5	5
	Off-State (Isolation)	5	0

### Pin Layout

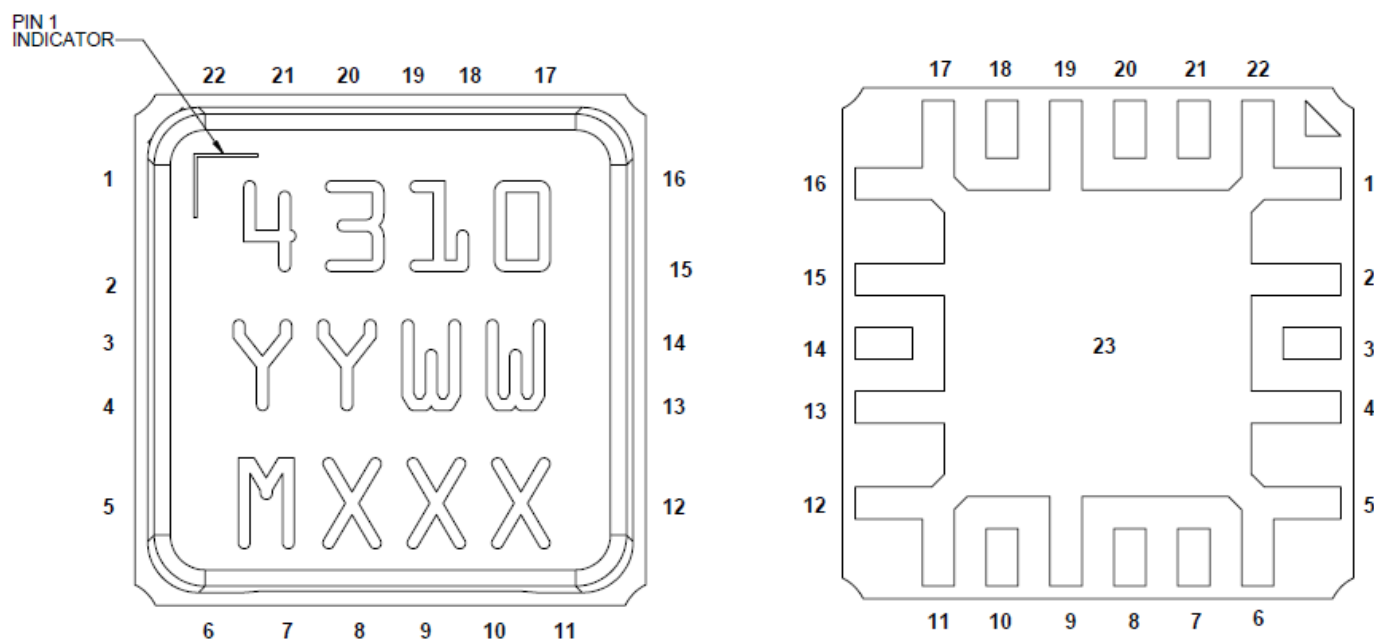

### Pin Description

Pin No.	Symbol	Description
1, 2, 4, 5-6, 9, 11-13, 15-17, 19, 22	GND	Connected to ground paddle (pin 23); must be grounded on PCB
3, 7, 8	NC	No connection
10	RF1	Switched RF port 1 (Output 1); matched to 50 $\Omega$ ; DC blocked
14	RFC	Common RF port (Input); matched to 50 $\Omega$ ; DC blocked
18	RF2	Switched RF port 2 (Output 2); matched to 50 $\Omega$ ; DC blocked
20	V <sub>DD</sub> (or V <sub>D</sub> )	Reference Voltage; no bias network required
21	V <sub>BIT</sub> (or V <sub>C</sub> )	Control Voltage; no bias network required
23	GND	Ground Paddle. Multiple vias should be employed to minimize inductance and thermal resistance.

### Evaluation Board

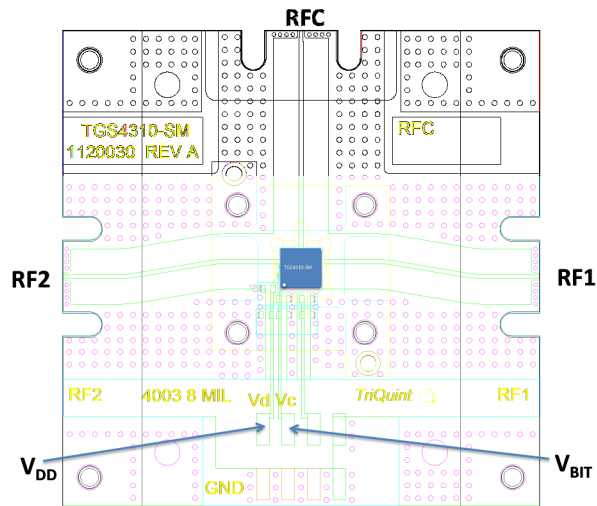

### Mechanical Information

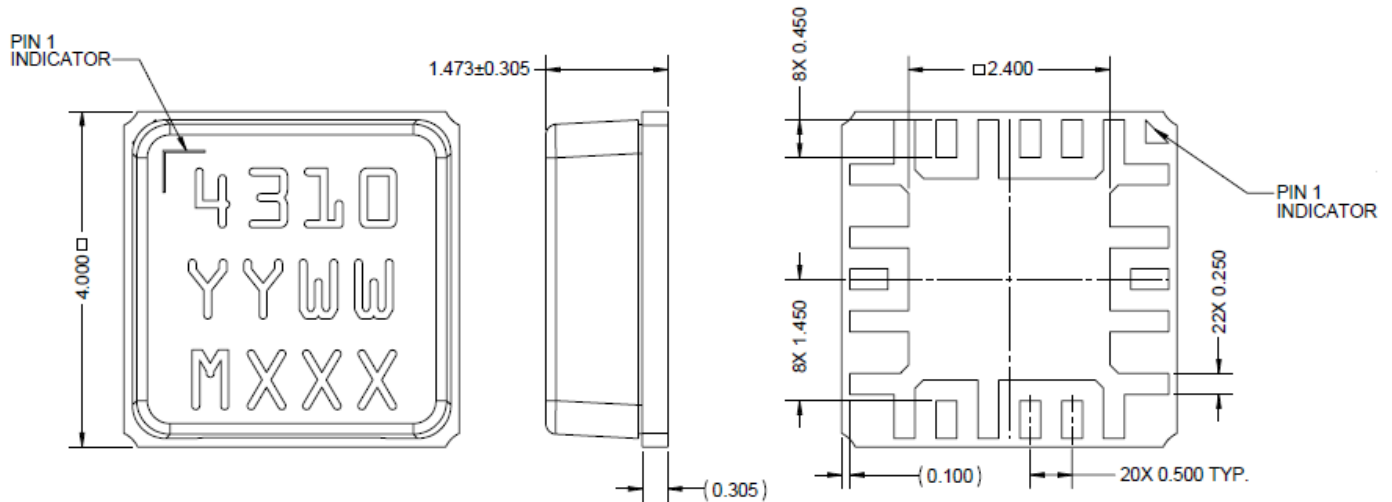

Units: mm

Tolerances: unless specified

x.xx = ± 0.25

x.xxx = ± 0.127

Materials:

Base: Ceramic

Lid: Plastic

All metalized features are gold plated

Part is epoxy sealed

Marking:

4310: Part number

YY: Part Assembly year

WW: Part Assembly week

MXXX: Batch ID

**Recommended Soldering Temperature Profile**

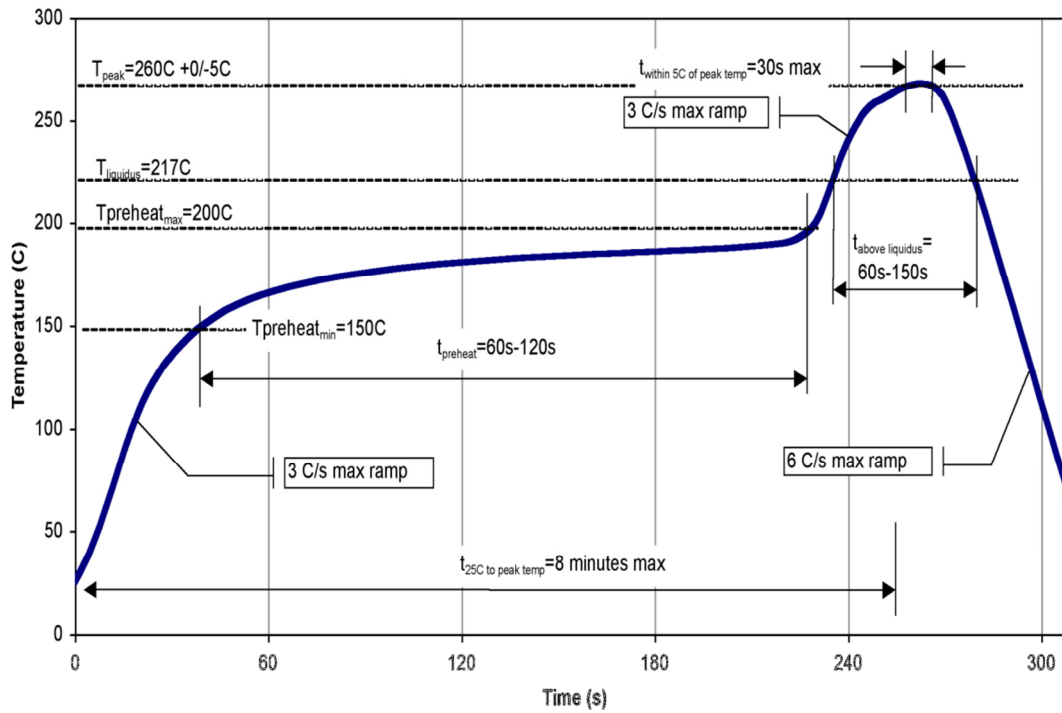

## Product Compliance Information

### ESD Sensitivity Ratings



Caution! ESD-Sensitive Device

ESD Rating: TBD  
Value: TBD  
Test: Human Body Model (HBM)  
Standard: JEDEC Standard JESD22-A114

### MSL Rating

Level TBD at TBD °C convection reflow  
The part is rated Moisture Sensitivity Level TBD at TBD °C  
per JEDEC standard IPC/JEDEC J-STD-020.

### ECCN

US Department of Commerce: EAR99

### Solderability

Compatible with the latest version of J-STD-020, Lead-free solder, 260 °C

### RoHS Compliance

This part is compliant with EU 2002/95/EC RoHS directive (Restrictions on the Use of Certain Hazardous Substances in Electrical and Electronic Equipment).

This product also has the following attributes:

- Lead Free
- Halogen Free (Chlorine, Bromine)
- Antimony Free
- TBBP-A (C<sub>15</sub>H<sub>12</sub>Br<sub>4</sub>O<sub>2</sub>) Free
- PFOS Free
- SVHC Free

## Contact Information

For the latest specifications, additional product information, worldwide sales and distribution locations, and information about TriQuint:

Web: [www.triquint.com](http://www.triquint.com)  
Email: [info-sales@triquint.com](mailto:info-sales@triquint.com)

Tel: +1.972.994.8465  
Fax: +1.972.994.8504

For technical questions and application information: Email: [info-products@triquint.com](mailto:info-products@triquint.com)

## Important Notice

The information contained herein is believed to be reliable. TriQuint makes no warranties regarding the information contained herein. TriQuint assumes no responsibility or liability whatsoever for any of the information contained herein. TriQuint assumes no responsibility or liability whatsoever for the use of the information contained herein. The information contained herein is provided "AS IS, WHERE IS" and with all faults, and the entire risk associated with such information is entirely with the user. All information contained herein is subject to change without notice. Customers should obtain and verify the latest relevant information before placing orders for TriQuint products. The information contained herein or any use of such information does not grant, explicitly or implicitly, to any party any patent rights, licenses, or any other intellectual property rights, whether with regard to such information itself or anything described by such information.

TriQuint products are not warranted or authorized for use as critical components in medical, life-saving, or life-sustaining applications, or other applications where a failure would reasonably be expected to cause severe personal injury or death.



Компания «ЭлектроПласт» предлагает заключение долгосрочных отношений при поставках импортных электронных компонентов на взаимовыгодных условиях!

Наши преимущества:

- Оперативные поставки широкого спектра электронных компонентов отечественного и импортного производства напрямую от производителей и с крупнейших мировых складов;
- Поставка более 17-ти миллионов наименований электронных компонентов;
- Поставка сложных, дефицитных, либо снятых с производства позиций;
- Оперативные сроки поставки под заказ (от 5 рабочих дней);
- Экспресс доставка в любую точку России;
- Техническая поддержка проекта, помощь в подборе аналогов, поставка прототипов;
- Система менеджмента качества сертифицирована по Международному стандарту ISO 9001;
- Лицензия ФСБ на осуществление работ с использованием сведений, составляющих государственную тайну;
- Поставка специализированных компонентов (Xilinx, Altera, Analog Devices, Intersil, Interpoint, Microsemi, Aeroflex, Peregrine, Syfer, Eurofarad, Texas Instrument, Miteq, Cobham, E2V, MA-COM, Hittite, Mini-Circuits, General Dynamics и др.);

Помимо этого, одним из направлений компании «ЭлектроПласт» является направление «Источники питания». Мы предлагаем Вам помощь Конструкторского отдела:

- Подбор оптимального решения, техническое обоснование при выборе компонента;
- Подбор аналогов;
- Консультации по применению компонента;
- Поставка образцов и прототипов;
- Техническая поддержка проекта;
- Защита от снятия компонента с производства.



#### Как с нами связаться

**Телефон:** 8 (812) 309 58 32 (многоканальный)

**Факс:** 8 (812) 320-02-42

**Электронная почта:** [org@eplast1.ru](mailto:org@eplast1.ru)

**Адрес:** 198099, г. Санкт-Петербург, ул. Калинина, дом 2, корпус 4, литера А.