

PART NUMBER	DESCRIPTION
CCR-40K	Commercial Latching SPDT, DC-40GHz, 2.92mm.
CR-40K	Elite Latching SPDT, DC-40GHz, 2.92mm.

The CCR-40K/CR-40K is a broadband, SPDT, electromechanical, coaxial switch designed to switch a microwave signal from a common input to either of two outputs. The characteristic impedance is 50 Ohms. These small switches incorporate 2.92mm high performance connectors. The CCR-40K/CR-40K series switch is offered with a latching actuator. The CCR-40K/CR-40K series is compatible with the two most common mounting hole patterns making it interchangeable with a variety of switches.



ENVIRONMENTAL AND PHYSICAL CHARACTERISTICS	
Operating Temperature	
Commercial Model, CCR-40K	-25°C to 65°C
Elite Model, CR-40K	-55°C to 85°C
Vibration (MIL-STD-202 Method 214, Condition D, non-operating)	10 g's RMS
Shock (MIL-STD-202 Method 213, Condition D, non-operating)	500 g's
Standard Actuator Life	5,000,000 cycles
Actuator Life w/ Additional Features	1,000,000 cycles
Connector Type	2.92 mm
Humidity (Moisture Seal)	Available
Weight	1.65 oz. (46.78g) (max.)

ELECTRICAL CHARACTERISTICS	
Form Factor	SPDT, break before make
Frequency Range	DC-40 GHz
Characteristic Impedance	50 Ohms
Operate Time	10 ms (max.)
Actuation Voltage Available	12 15 24 28 V
Actuation Current, max. @ ambient temp.	140 170 90 65 mA

TYPICAL PERFORMANCE CHARACTERISTICS						
Frequency	DC-6 GHz	6-12 GHz	12-18 GHz	18-27 GHz	27-34 GHz	34-40 GHz
Insertion Loss, dB, max.	0.2	0.4	0.5	0.6	0.7	0.8
Isolation, dB, min.	70	60	60	50	50	50
VSWR, max.	1.25:1	1.40:1	1.50:1	1.60:1	1.80:1	1.80:1

For maximum limits, please see charts on page 3

PART NUMBERING SYSTEM

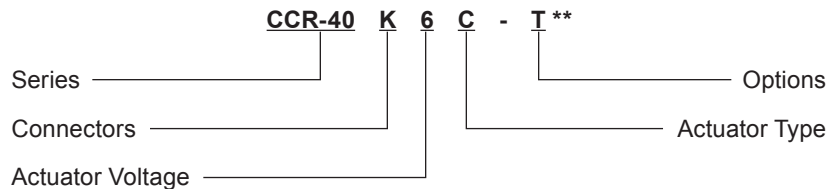

Connector
K: 2.92mm Female

Actuator Voltage
6: 28 Vdc Latching
7: 15 Vdc Latching
8: 12 Vdc Latching
9: 24 Vdc Latching

Actuator Type
0: Standard Contacts
C: Indicator Contacts***
D: Self Cutoff Only
E: Indicators and Self Cutoff***

Options
T: TTL Drivers with Diodes
D: Transient Suppression Diodes
R: Positive + Common
N: Narrow Body
S: 9-Pin D-Sub Connector

**SEE PARTS LIST ON PAGES 8-9

*** Indicator Contacts Operating Temperature -50°C to 85°C (Elite Model Only)

For other options, contact factory.

Series CCR-40K/CR-40K

Miniature DC-40 GHz
Latching SPDT Coaxial Switch



SCHEMATICS AND MECHANICAL OUTLINE

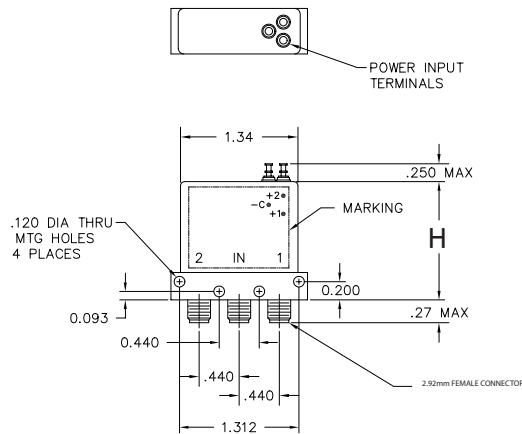
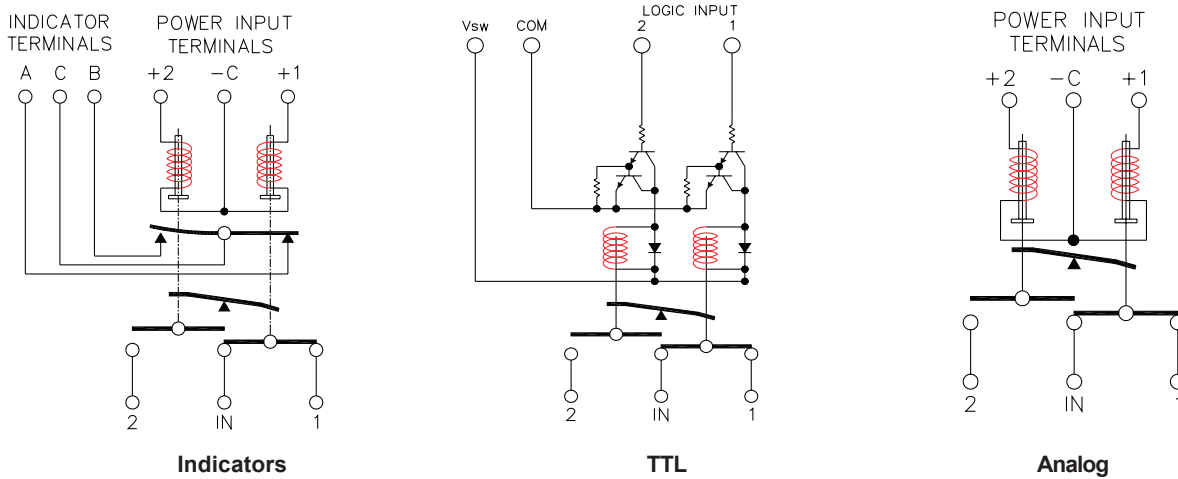

Standard Width Body

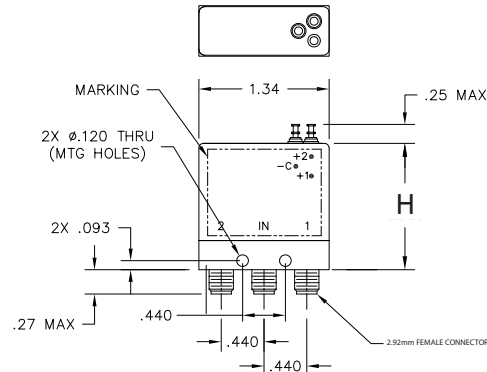

Optional Narrow Width Body

H = 1.45 MAX. STD MODEL
H = 1.80 MAX. TTL MODEL OR SUB-D
H = 2.20 MAX. TTL + SUB-D

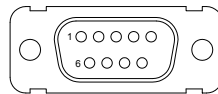

“-S OPTION” 9-PIN D-SUB CONNECTOR (EXAMPLE: CCR-40K60-s)

9 PIN D-SUB PINOUT FOR LATCHING SPDT				
Pin No.	OPTIONS			
	Basic	Indicators	TTL	Indicators & TTL
1	1	1		
2	2	2		
3	C	C	Common	Common
4			1	1
5			2	2
6			Vsw	Vsw
7		A		A
8		B		B
9		C		C

TRUTH TABLE (with TTL option)					
Logic Input		RF Path		Indicator (if applicable)	
1	2	IN to 1	IN to 2	A	B
0	0	No Change			
1	0	On	Off	C	0
0	1	Off	On	0	C
1	1	Forbidden			

TYPICAL RF INSERTION LOSS PERFORMANCE CURVES

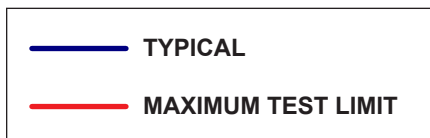
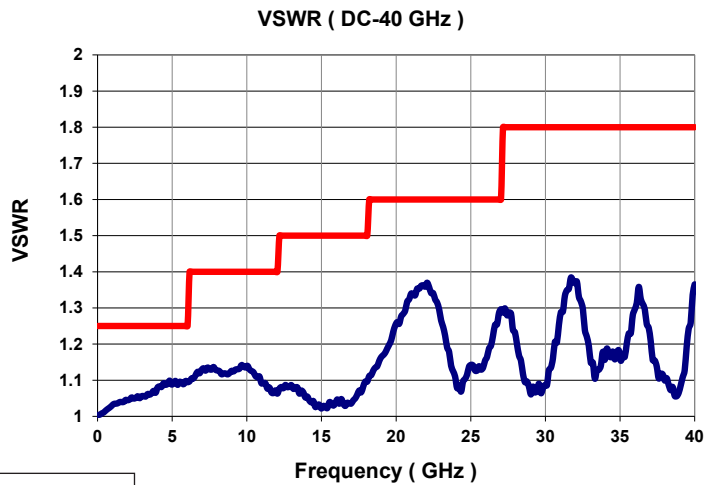
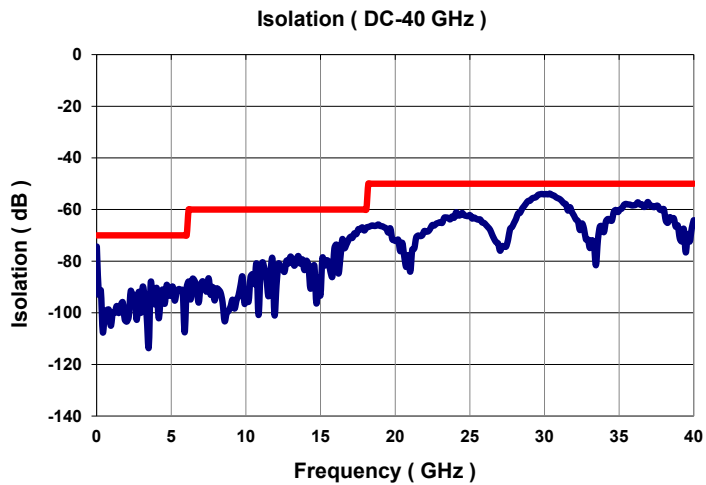
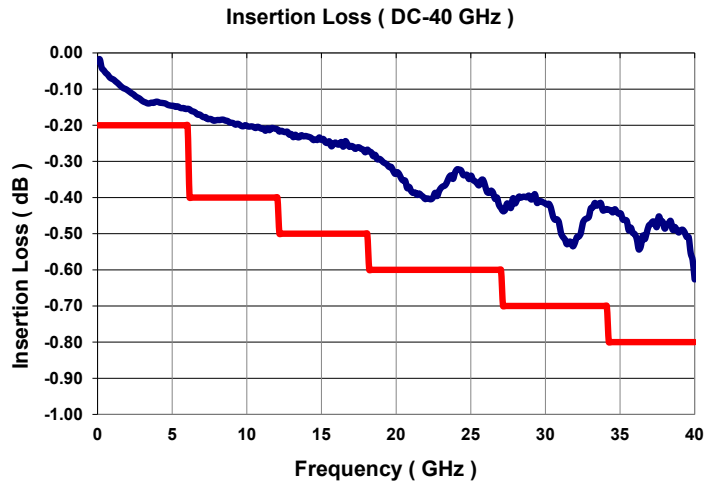

Series CCR-40K/CR-40K

Miniature DC-40 GHz

Latching SPDT Coaxial Switch



GLOSSARY

Actuator

An actuator is the electromechanical mechanism that transfers the RF contacts from one position to another upon DC command.

Arc Suppression Diode

A diode is connected in parallel with the coil. This diode limits the “reverse EMF spike” generated when the coil de-energizes to 0.7 volts. The diode cathode is connected to the positive side of the coil and the anode is connected to the negative side.

Date Code

All switches are marked with either a unique serial number or a date code. Date codes are in accordance with MIL-STD-1285 Paragraph 5.2.5 and consist of four digits. The first two digits define the year and the last two digits define the week of the year (YYWW). Thus, 1032 identifies switches that passed through final inspection during the 32nd week of 2010.

Latching

A latching switch remains in the selected position whether or not voltage is maintained. This can be accomplished with either a magnetic or mechanical latching mechanism.

Indicator

Indicators tell the system which position the switch is in. Other names for indicators are telemetry contacts or tellback circuit. Indicators are usually a set of internally mounted DC contacts linked to the actuator. They can be wired to digital input lines, status lights, or interlocks. Unless otherwise specified, the maximum indicator contact rating is 30 Vdc, 50 mA, or 1.5 Watts into a resistive load.

Isolation

Isolation is the measure of the power level at the output connector of an unconnected RF channel as referenced to the power at the input connector. It is specified in dB below the input power level.

Self-Cutoff

The self-cutoff option disables the actuator current on completion of actuation. Either a series contact (linked to the actuator) or an IC driver circuit provides the current cutoff. This option results in minimum power consumption by the RF switch. Cutthroat is another name used in the industry for this option. Pulse latching is a term used to describe a switch without this feature.

SPDT Switch

A single-pole double-throw, bi-directional switch that can be used as having one input and two outputs or two inputs and one output.

Switching Time

Switching time is the total interval beginning with the arrival of the leading edge of the command pulse at the switch DC input and ending with the completion of the switch transfer,

including contact bounce. It consists of three parts: (1) inductive delay in the coil, (2) transfer time of the physical movement of the contacts, and (3) the bounce time of the RF contacts.

TTL Switch Driver Option

As a special option, switch drivers can be provided for both failsafe and latching switches, which are compatible with industry-standard low-power Schottky TTL circuits.

Performance Parameters vs Frequency

Generally speaking, the RF performance of coaxial switches is frequency dependent. With increasing frequency, VSWR and insertion loss increase while isolation decreases. All data sheets specify these three parameters as “worst case” at the highest operating frequency. If the switch is to be used over a narrow frequency band, better performance can be achieved.

Actuator Current vs Temperature

The resistance of the actuator coil varies as a function of temperature. There is an inverse relationship between the operating temperature of the switch and the actuator drive current. For switches operating at 28 VDC, the approximate actuator drive current at temperature, T, can be calculated using the equation:

$$I_T = \frac{I_A}{[1 + .00385 (T-20)]}$$

Where:

I_T = Actuator current at temperature, T

I_A = Room temperature actuator current – see data sheet

T = Temperature of interest in °C

Magnetic Sensitivity

An electro-mechanical switch can be sensitive to ferrous materials and external magnetic fields. Neighboring ferrous materials should be permitted no closer than 0.5 inches and adjacent external magnetic fields should be limited to a flux density of less than 5 Gauss.

SPECIAL FEATURE

Switching High-Power or Highly Sensitive Signals

Ensure the most linear response with the best galvanically matched contact system in the industry. Extremely low passive intermodulation is standard on all of our switches.

Carrier Frequency 1	Carrier Frequency 2	PIM 3rd Order Frequency	PIM 5th Order Frequency
870 MHz	893 MHz	847 MHz	824 MHz

	3rd Order Intermodulation	5th Order Intermodulation
SPDT	-91 dBm	-110 dBm
	-134 dBc	-153 dBc

LATCHING CCR-40K/CR-40K PART NUMBER LIST

	PART No.		PART No.		PART No.		PART No.
1	CCR-40KXC	43	CCR-40KXD-N	85	CCR-40KXE-TNM	127	CR-40KXC
2	CCR-40KXC-D	44	CCR-40KXD-N	86	CCR-40KXE-TNMS	128	CR-40KXC-D
3	CCR-40KXC-DM	45	CCR-40KXD-NM	87	CCR-40KXE-TNS	129	CR-40KXC-DM
4	CCR-40KXC-DMS	46	CCR-40KXD-NMS	88	CCR-40KX0	130	CR-40KXC-DMS
5	CCR-40KXC-DN	47	CCR-40KXD-NS	89	CCR-40KX0-D	131	CR-40KXC-DN
6	CCR-40KXC-DNM	48	CCR-40KXD-R	90	CCR-40KX0-DM	132	CR-40KXC-DNM
7	CCR-40KXC-DNMS	49	CCR-40KXD-RM	91	CCR-40KX0-DMS	133	CR-40KXC-DNMS
8	CCR-40KXC-DNS	50	CCR-40KXD-RMS	92	CCR-40KX0-DN	134	CR-40KXC-DNS
9	CCR-40KXC-DR	51	CCR-40KXD-RN	93	CCR-40KX0-DNM	135	CR-40KXC-DR
10	CCR-40KXC-DRM	52	CCR-40KXD-RNM	94	CCR-40KX0-DNMS	136	CR-40KXC-DRM
11	CCR-40KXC-DRMS	53	CCR-40KXD-RNMS	95	CCR-40KX0-DNS	137	CR-40KXC-DRMS
12	CCR-40KXC-DRN	54	CCR-40KXD-RNS	96	CCR-40KX0-DR	138	CR-40KXC-DRN
13	CCR-40KXC-DRNMS	55	CCR-40KXD-RS	97	CCR-40KX0-DRM	139	CR-40KXC-DRNMS
14	CCR-40KXC-DRNS	56	CCR-40KXD-S	98	CCR-40KX0-DRMS	140	CR-40KXC-DRNS
15	CCR-40KXC-DRS	57	CCR-40KXD-T	99	CCR-40KX0-DRN	141	CR-40KXC-DRS
16	CCR-40KXC-DS	58	CCR-40KXD-TM	100	CCR-40KX0-DRNMS	142	CR-40KXC-DS
17	CCR-40KXC-M	59	CCR-40KXD-TMS	101	CCR-40KX0-DRNS	143	CR-40KXC-M
18	CCR-40KXC-MS	60	CCR-40KXD-TN	102	CCR-40KX0-DRS	144	CR-40KXC-MS
19	CCR-40KXC-N	61	CCR-40KXD-TNM	103	CCR-40KX0-DS	145	CR-40KXC-N
20	CCR-40KXC-NM	62	CCR-40KXD-TNMS	104	CCR-40KX0-M	146	CR-40KXC-NM
21	CCR-40KXC-NMS	63	CCR-40KXD-TNS	105	CCR-40KX0-MS	147	CR-40KXC-NMS
22	CCR-40KXC-NS	64	CCR-40KXE	106	CCR-40KX0-N	148	CR-40KXC-NS
23	CCR-40KXC-R	65	CCR-40KXE-M	107	CCR-40KX0-NM	149	CR-40KXC-R
24	CCR-40KXC-RM	66	CCR-40KXE-MS	108	CCR-40KX0-NMS	150	CR-40KXC-RM
25	CCR-40KXC-RMS	67	CCR-40KXE-N	109	CCR-40KX0-NS	151	CR-40KXC-RMS
26	CCR-40KXC-RN	68	CCR-40KXE-N	110	CCR-40KX0-R	152	CR-40KXC-RN
27	CCR-40KXC-RNM	69	CCR-40KXE-NM	111	CCR-40KX0-RM	153	CR-40KXC-RNM
28	CCR-40KXC-RNMS	70	CCR-40KXE-NMS	112	CCR-40KX0-RMS	154	CR-40KXC-RNMS
29	CCR-40KXC-RNS	71	CCR-40KXE-NS	113	CCR-40KX0-RN	155	CR-40KXC-RNS
30	CCR-40KXC-RS	72	CCR-40KXE-R	114	CCR-40KX0-RNM	156	CR-40KXC-RS
31	CCR-40KXC-S	73	CCR-40KXE-RM	115	CCR-40KX0-RNMS	157	CR-40KXC-S
32	CCR-40KXC-T	74	CCR-40KXE-RMS	116	CCR-40KX0-RNS	158	CR-40KXC-T
33	CCR-40KXC-TM	75	CCR-40KXE-RN	117	CCR-40KX0-RS	159	CR-40KXC-TM
34	CCR-40KXC-TMS	76	CCR-40KXE-RNM	118	CCR-40KX0-S	160	CR-40KXC-TMS
35	CCR-40KXC-TN	77	CCR-40KXE-RNMS	119	CCR-40KX0-T	161	CR-40KX0-T
36	CCR-40KXC-TNM	78	CCR-40KXE-RNS	120	CCR-40KX0-TM	162	CR-40KX0-TM
37	CCR-40KXC-TNMS	79	CCR-40KXE-RS	121	CCR-40KX0-TMS	163	CR-40KX0-TMS
38	CCR-40KXC-TNS	80	CCR-40KXE-S	122	CCR-40KX0-TN	164	CR-40KX0-TN
39	CCR-40KXC-TS	81	CCR-40KXE-T	123	CCR-40KX0-TNM	165	CR-40KX0-TNM
40	CCR-40KXD	82	CCR-40KXE-TM	124	CCR-40KX0-TNMS	166	CR-40KX0-TNMS
41	CCR-40KXD-M	83	CCR-40KXE-TMS	125	CCR-40KX0-TNS	167	CR-40KX0-TNS
42	CCR-40KXD-MS	84	CCR-40KXE-TN	126	CCR-40KX0-TS	168	CR-40KX0-TS

* X = 6 (28Vdc), 7 (15Vdc), 8 (12Vdc) and 9 (24Vdc)

Series CCR-40K/CR-40K

Miniature DC-40 GHz

Latching SPDT Coaxial Switch



LATCHING CCR-40K/CR-40K PART NUMBER LIST

	PART No.		PART No.
169	CR-40KXC-TN	211	CR-40KXE-RNMS
170	CR-40KXC-TNM	212	CR-40KXE-RNS
171	CR-40KXC-TNMS	213	CR-40KXE-RS
172	CR-40KXC-TNS	214	CR-40KXE-S
173	CR-40KXC-TS	215	CR-40KXE-T
174	CR-40KXD	216	CR-40KXE-TM
175	CR-40KXD-M	217	CR-40KXE-TMS
176	CR-40KXD-MS	218	CR-40KXE-TN
177	CR-40KXD-N	219	CR-40KXE-TNM
178	CR-40KXD-N	220	CR-40KXE-TNMS
179	CR-40KXD-NM	221	CR-40KXE-TNS
180	CR-40KXD-NMS	222	CR-40KX0
181	CR-40KXD-NS	223	CR-40KX0-D
182	CR-40KXD-R	224	CR-40KX0-DM
183	CR-40KXD-RM	225	CR-40KX0-DMS
184	CR-40KXD-RMS	226	CR-40KX0-DN
185	CR-40KXD-RN	227	CR-40KX0-DNM
186	CR-40KXD-RNM	228	CR-40KX0-DNMS
187	CR-40KXD-RNMS	229	CR-40KX0-DNS
188	CR-40KXD-RNS	230	CR-40KX0-DR
189	CR-40KXD-RS	231	CR-40KX0-DRM
190	CR-40KXD-S	232	CR-40KX0-DRMS
191	CR-40KXD-T	233	CR-40KX0-DRN
192	CR-40KXD-TM	234	CR-40KX0-DRNMS
193	CR-40KXD-TMS	235	CR-40KX0-DRNS
194	CR-40KXD-TN	236	CR-40KX0-DRS
195	CR-40KXD-TNM	237	CR-40KX0-DS
196	CR-40KXD-TNMS	238	CR-40KX0-M
197	CR-40KXD-TNS	239	CR-40KX0-MS
198	CR-40KXE	240	CR-40KX0-N
199	CR-40KXE-M	241	CR-40KX0-NM
200	CR-40KXE-MS	242	CR-40KX0-NMS
201	CR-40KXE-N	243	CR-40KX0-NS
202	CR-40KXE-N	244	CR-40KX0-R
203	CR-40KXE-NM	245	CR-40KX0-RM
204	CR-40KXE-NMS	246	CR-40KX0-RMS
205	CR-40KXE-NS	247	CR-40KX0-RN
206	CR-40KXE-R	248	CR-40KX0-RNM
207	CR-40KXE-RM	249	CR-40KX0-RNMS
208	CR-40KXE-RMS	250	CR-40KX0-RNS
209	CR-40KXE-RN	251	CR-40KX0-RS
210	CR-40KXE-RNM	252	CR-40KX0-S

* X = 6 (28Vdc), 7 (15Vdc), 8 (12Vdc) and 9 (24Vdc)



Компания «ЭлектроПласт» предлагает заключение долгосрочных отношений при поставках импортных электронных компонентов на взаимовыгодных условиях!

Наши преимущества:

- Оперативные поставки широкого спектра электронных компонентов отечественного и импортного производства напрямую от производителей и с крупнейших мировых складов;
- Поставка более 17-ти миллионов наименований электронных компонентов;
- Поставка сложных, дефицитных, либо снятых с производства позиций;
- Оперативные сроки поставки под заказ (от 5 рабочих дней);
- Экспресс доставка в любую точку России;
- Техническая поддержка проекта, помощь в подборе аналогов, поставка прототипов;
- Система менеджмента качества сертифицирована по Международному стандарту ISO 9001;
- Лицензия ФСБ на осуществление работ с использованием сведений, составляющих государственную тайну;
- Поставка специализированных компонентов (Xilinx, Altera, Analog Devices, Intersil, Interpoint, Microsemi, Aeroflex, Peregrine, Syfer, Eurofarad, Texas Instrument, Miteq, Cobham, E2V, MA-COM, Hittite, Mini-Circuits, General Dynamics и др.);

Помимо этого, одним из направлений компании «ЭлектроПласт» является направление «Источники питания». Мы предлагаем Вам помощь Конструкторского отдела:

- Подбор оптимального решения, техническое обоснование при выборе компонента;
- Подбор аналогов;
- Консультации по применению компонента;
- Поставка образцов и прототипов;
- Техническая поддержка проекта;
- Защита от снятия компонента с производства.



Как с нами связаться

Телефон: 8 (812) 309 58 32 (многоканальный)

Факс: 8 (812) 320-02-42

Электронная почта: org@eplast1.ru

Адрес: 198099, г. Санкт-Петербург, ул. Калинина, дом 2, корпус 4, литера А.