

Features

Regulated Converter

- 4:1 wide input range
- 3kVAC reinforced insulation for 110Vin
2.25kVDC basic insulation for 24Vin & 48Vin
- Efficiency up to 90%
- No minimum load required
- EN50155 certified
- IEC/EN60950-1 certified

RECOM DC/DC Converter

RP90Q-RW

**90 Watt
Quarter
Brick
Single Output**



Description

The quarter-brick RP90Q series DC/DC converters are designed for railway rolling stock and high voltage battery applications. Each series has three 4:1 input voltage range options to cover all input voltages from 9VDC up to 160VDC with isolated and regulated 5V to 48VDC outputs. The converters have high efficiencies and metal base-plates to permit a wide operating temperature range from -40°C to +85°C (when mounted on a suitable heatsink). The case is fitted with threaded inserts to allow secure mounting to the PCB or bulkhead for use in high shock and vibration environments. The converters are EN50155 and IEC/EN60950 certified. The RP90Q-RW series have a three year warranty.

Selection Guide

Part Number	Input Voltage Range [VDC]	Output Voltage [VDC]	Output Current [mA]	Input ⁽¹⁾ Current [mA]	Output Power [W]	Efficiency ⁽¹⁾ typ. [%]	Max. Capacitive Load [µF]
RP90Q-2405SRW ^(2,3)	9-36	5	18000	4213	90	89	36000
RP90Q-2412SRW ^(2,3)	9-36	12	7500	4213	90	89	6250
RP90Q-2415SRW ^(2,3)	9-36	15	6000	4213	90	89	4000
RP90Q-2424SRW ^(2,3)	9-36	24	3700	4157	89	89	1540
RP90Q-2448SRW ^(2,3)	9-36	48	1800	4090	86.5	88	380
RP90Q-4805SRW ^(2,3)	16.5-75	5	18000	2107	90	89	36000
RP90Q-4812SRW ^(2,3)	16.5-75	12	7500	2107	90	89	6250
RP90Q-4815SRW ^(2,3)	16.5-75	15	6000	2083	90	90	4000
RP90Q-4824SRW ^(2,3)	16.5-75	24	3700	2055	89	90	1540
RP90Q-4848SRW ^(2,3)	16.5-75	48	1800	2000	86.5	90	380
RP90Q-11005SRW ^(2,3)	40-160	5	17000	868	85	89	34000
RP90Q-11012SRW ^(2,3)	40-160	12	7000	858	84	89	5830
RP90Q-11015SRW ^(2,3)	40-160	15	5500	843	82.5	89	3670
RP90Q-11024SRW ^(2,3)	40-160	24	3500	858	84	89	1460
RP90Q-11048SRW ^(2,3)	40-160	48	1800	882	86.5	89	380

Notes:

Note1: Efficiency is tested by nominal Vin, full load and at 25°C



EN50155 certified
IEC/EN60950-1 certified

Model Numbering

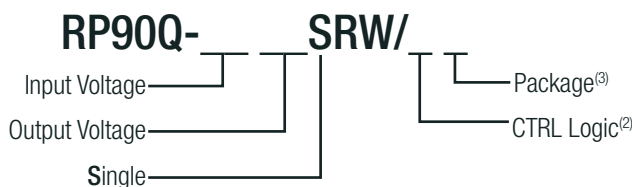

Ordering Examples

- RP90Q-2405SRW/N = 24V Input, 5V Output, Single, Neg. CTRL function
- RP90Q-11012SRW/P = 110V Input, 12V Output, Single, Pos. CTRL function
- RP90Q-2405SRW/N-HC = 24V Input, 5V Output, Single, Neg. CTRL function, with pre-mounted Heat-sink

Notes:

- Note2: standard part is with suffix "P" for positive logic (1=ON, 0=OFF) or add suffix "N" instead for negative logic (0=ON, 1=OFF)
- Note3: add suffix "-HC" for pre-mounted Heat-sink (compatible with all other suffixes)



www.recom-power.com/eval-ref-boards



https://www.recom-power.com/pdf/Powerline_DC-DC/RSPxxx-168.pdf

Specifications (measured @Ta = 25°C, resistive load, nominal Vin and rated Iout unless otherwise noted)

BASIC CHARACTERISTICS

Parameter	Condition	Min.	Typ.	Max.
Internal Input Filter				Pi-Type
Input Voltage Range	nom Vin = 24V nom Vin = 48V nom Vin = 110V	9VDC 16.5VDC 40VDC	24VDC 48VDC 110VDC	36VDC 75VDC 160VDC
Input Surge Voltage	Vin = 24V, 1s max. Vin = 48V, 1s max. Vin = 110V, 1s max.			50VDC 100VDC 185VDC
Quiescent Current	Vin = 24V Vin = 48V Vin = 110V		25ma 15mA 8mA	
Start-up time	Power up ON/OFF Control		75ms 75ms	100ms 100ms
Internal Operating Frequency		270kHz	300kHz	330kHz
Minimum Load		0%		
Ripple and Noise	Measured by 20MHz BW with a 22µF/25V X7R MLCC with a 22µF/25V X7R MLCC with a 4.7µF/50V X7R MLCC with a 2.2µF/100V X7R MLCC	5 Vout 12, 15Vout 24Vout 48Vout	75mVp-p 100mVp-p 200mVp-p 300mVp-p	
Under Voltage Lockout (UVLO)	Vin = 24V	DC-DC ON DC-DC OFF	7.3VDC	9VDC 8.1VDC
	Vin = 48V	DC-DC ON DC-DC OFF	15.5VDC	18VDC 16.3VDC
	Vin = 110V	DC-DC ON DC-DC OFF	33VDC	43VDC 36VDC
ON/OFF Control	Positive Logic	DC-DC ON DC-DC OFF		Open or 3.0V < Vr < 12V Short or 0V < Vr < 1.2V
	Negative Logic	DC-DC ON DC-DC OFF		Short or 0V < Vr < 1.2V Open or 3.0V < Vr < 12V
Input Current of CTRL pin		-0.5mA		1mA
Standby Current			3mA	
Output Trim		-20%		+10%
Remote Sense	% of set Vout			10%

RP90Q-2405SRW

Efficiency vs. Output Current

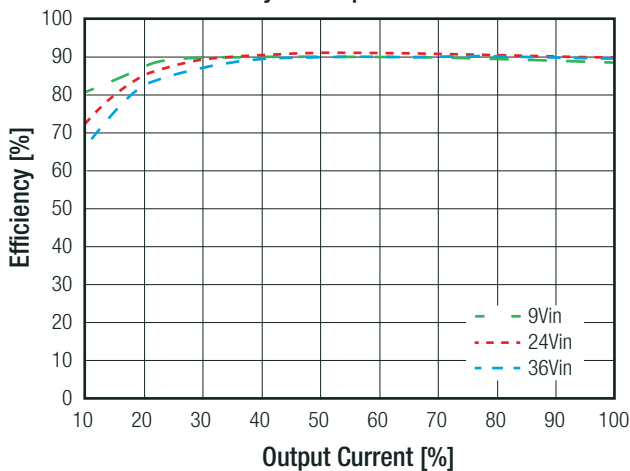

Efficiency vs. Input Voltage

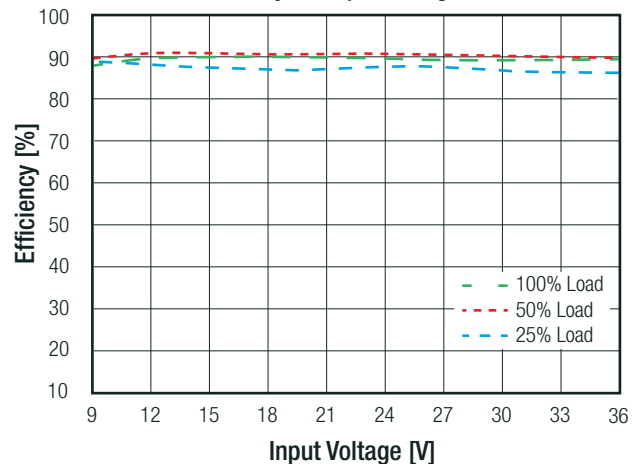

continued on next page

Specifications (measured @Ta = 25°C, resistive load, nominal Vin and rated Iout unless otherwise noted)

RP90Q-2405SRW

Power Dissipation vs. Output Current

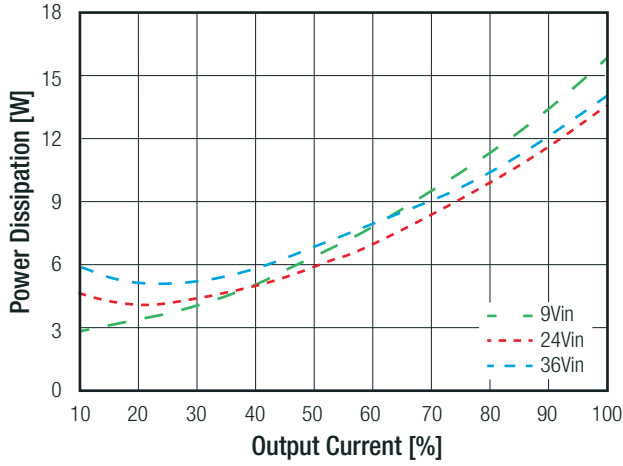

Typical Output Ripple and Noise/full load

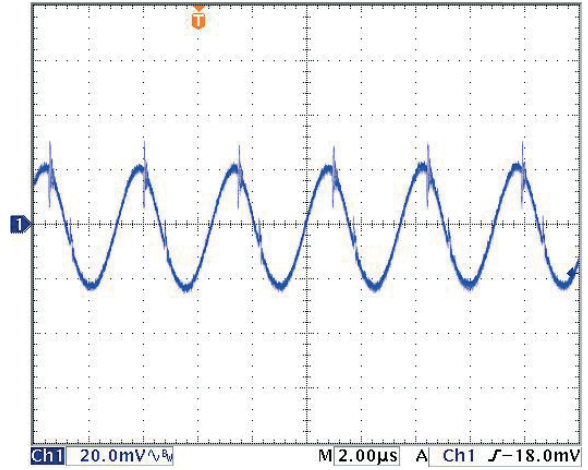

ON/OFF Control Start up Rise Characteristic

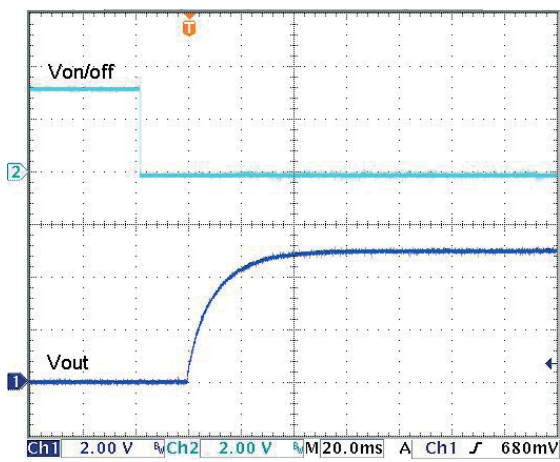

Power up Start-up Rise Characteristic

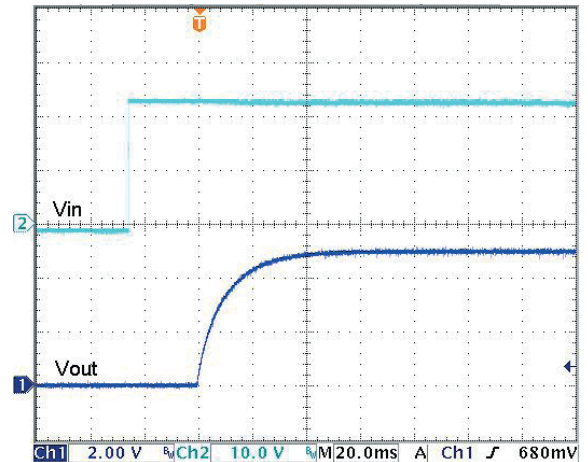

RP90Q-4805SRW

Efficiency vs. Output Current

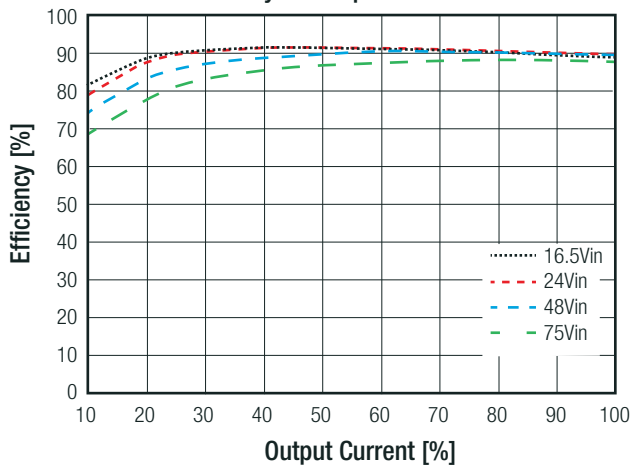

Efficiency vs. Input Voltage

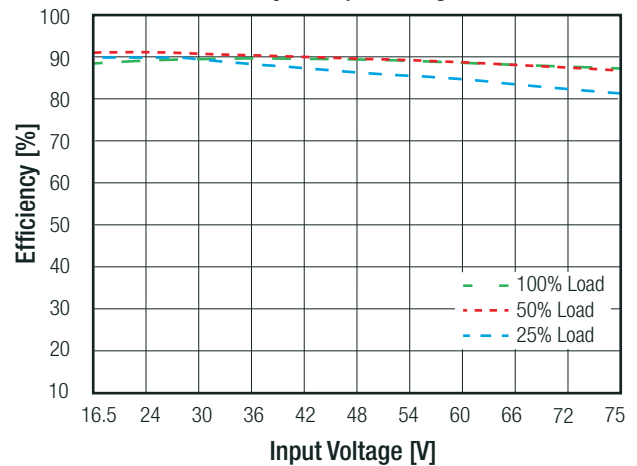

continued on next page

Specifications (measured @Ta = 25°C, resistive load, nominal Vin and rated Iout unless otherwise noted)

RP90Q-4805SRW

Power Dissipation vs. Output Current

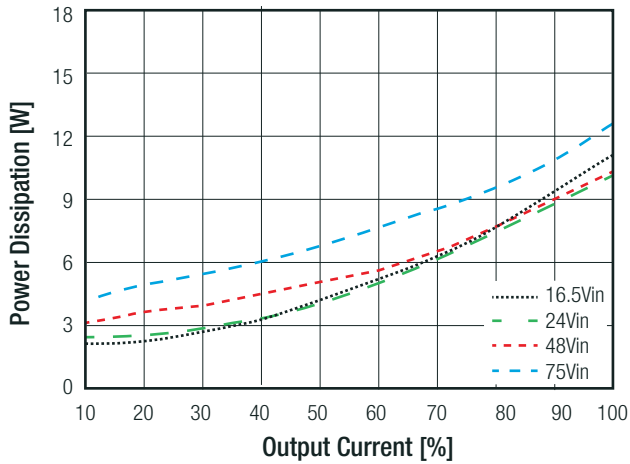

Typical Output Ripple and Noise/full load

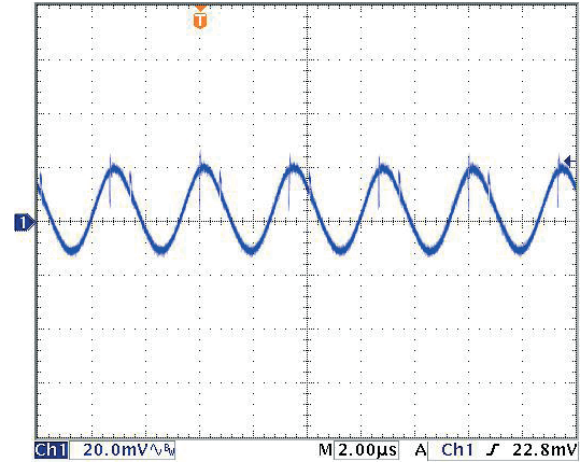

ON/OFF Control Start up Rise Characteristic

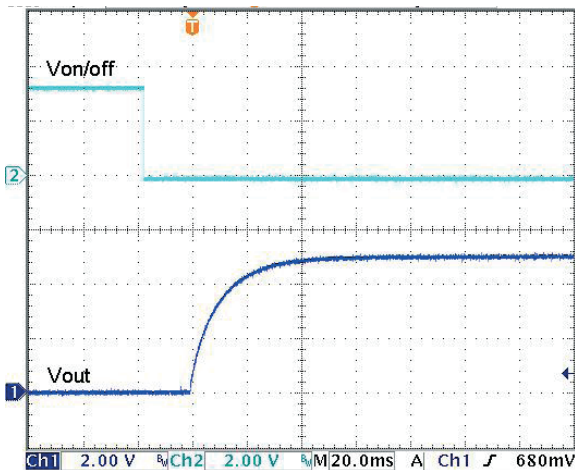

Power up Start-up Rise Characteristic

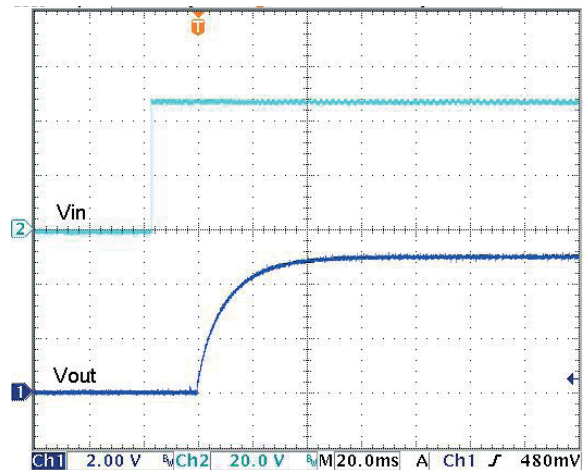

RP90Q-11005SRW

Efficiency vs. Output Current

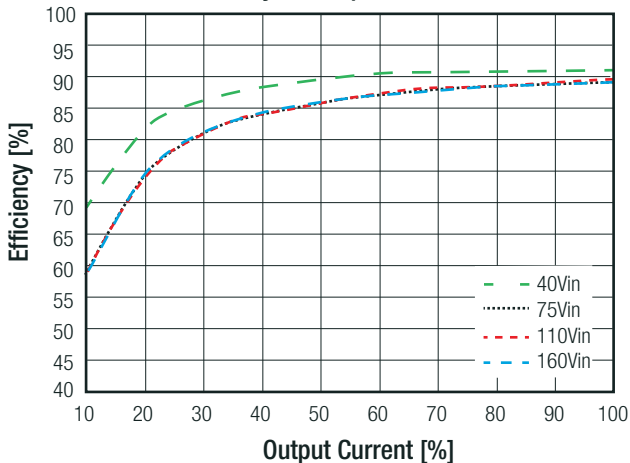

Efficiency vs. Input Voltage

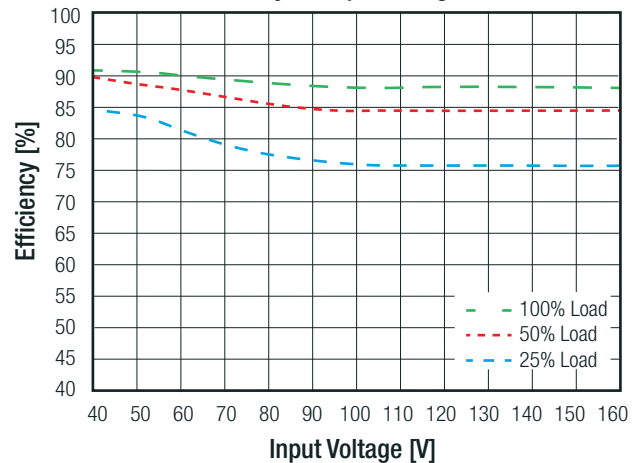

continued on next page

Specifications (measured @Ta = 25°C, resistive load, nominal Vin and rated Iout unless otherwise noted)

RP90Q-11005SRW

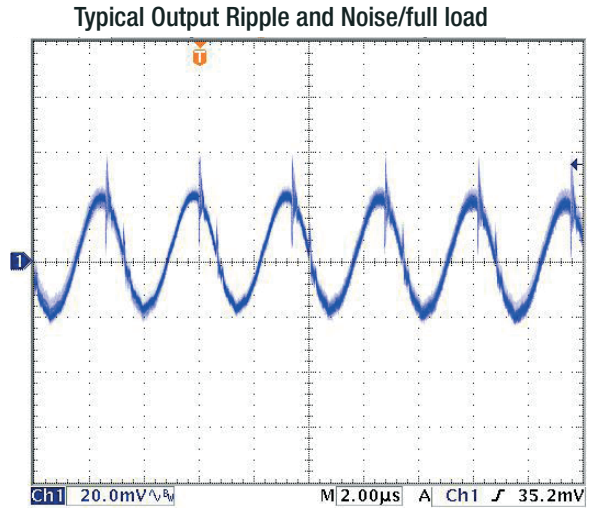
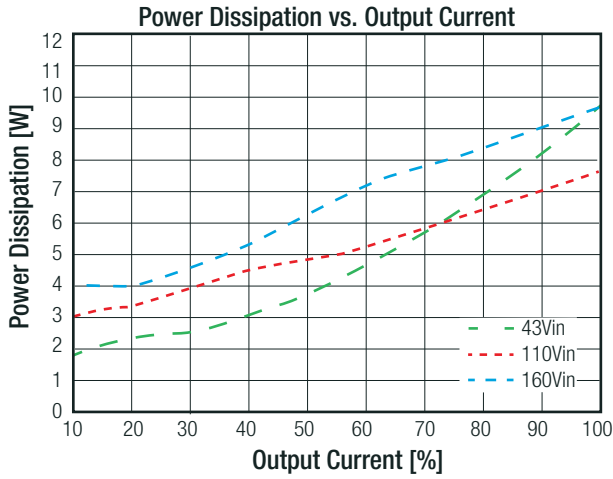

ON/OFF Control Start up Rise Characteristic

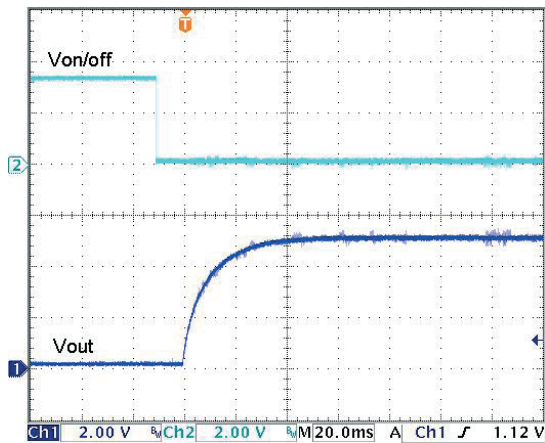

Power up Start-up Rise Characteristic

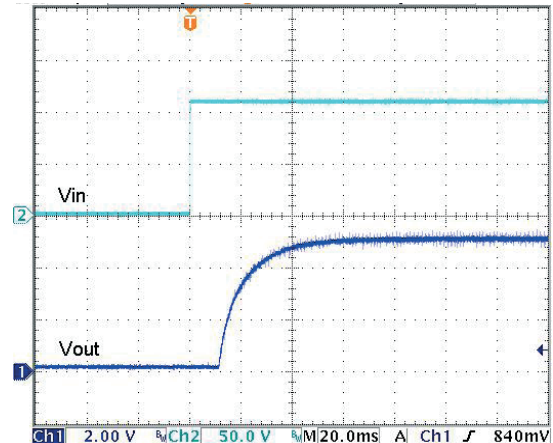

OUTPUT TRIM

Output Voltage Trimming

It allows the user to increase or decrease the output voltage of the module. This is accomplished by connecting an external resistor between the Trim pin and either the +Sense or -Sense pins. With an external resistor between the Trim and +Sense pin, the output voltage increases. With an external resistor between the Trim and -Sense pin, the output voltage decreases. The external Trim resistor needs to be at least 1/8W of rated. The values for trim resistors shown in trim tables below are according to standard E96 values; therefore, the specified voltage may slightly vary.

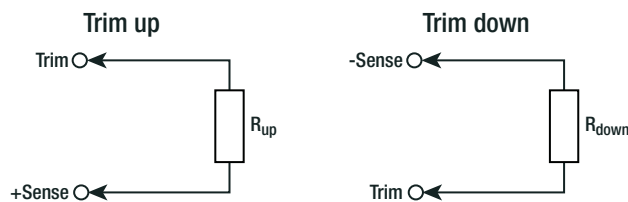

continued on next page

Specifications (measured @Ta = 25°C, resistive load, nominal Vin and rated Iout unless otherwise noted)

OUTPUT TRIM

V_{out_nom} = nominal output voltage [VDC]
 ΔV_{out} = output voltage change [%]
 V_{ref} = reference voltage [VDC]
 R_{up} = trim up resistor [Ω]
 R_{down} = trim down resistor [Ω]
 R_1 & R_2 = internal resistors [Ω]

V_{out_nom}	R_1	R_2	R_3	V_{ref}
5VDC	10k2 Ω	511k Ω	5k11	1.225VDC
12VDC				
15VDC				
24VDC				
48VDC				

Calculation:

$$R_{up} = \left[\frac{R_3 \times V_{out_nom} \times (100 + \Delta V_{out})}{V_{ref} \times \Delta V_{out}} \right] - \left[\frac{(R_1 \times \Delta V_{out}) + R_2}{\Delta V_{out}} \right]$$

$$R_{down} = \left[\frac{R_2}{\Delta V_{out}} \right] - R_1$$

Practical Example RP90Q-xx05SRW +10% / -10%

$$R_{up} = \left[\frac{5k11 \times 5 \times (100 + 10)}{1.225 \times 10} \right] - \left[\frac{(10k2 \times 10) + 511k}{10} \right] = 168k\Omega$$

$$R_{down} = \left[\frac{511k}{10} \right] - 10k2 = 40k9\Omega$$

R_{up} according to E96 \approx 169k Ω

R_{down} according to E96 \approx 41k2 Ω

RP90Q-xx05SRW

Trim up	1	2	3	4	5	6	7	8	9	10	[%]
$V_{out_set} =$	5.05	5.10	5.15	5.20	5.25	5.30	5.35	5.4	5.45	5.50	[VDC]
R_{up} (E96) \approx	1M58	806k	536k	402k	324k	247k	237k	205k	187k	169k	[Ω]

RP90Q-xx12SRW

Trim up	1	2	3	4	5	6	7	8	9	10	[%]
$V_{out_set} =$	12.12	12.24	12.36	12.48	12.60	12.72	12.84	12.96	13.08	13.20	[VDC]
R_{up} (E96) \approx	4M53	2M26	1M54	1M15	931k	787k	681k	604k	536k	487k	[Ω]

RP90Q-xx15SRW

Trim up	1	2	3	4	5	6	7	8	9	10	[%]
$V_{out_set} =$	15.15	15.30	15.45	15.60	15.75	15.90	16.05	16.20	16.35	16.50	[VDC]
R_{up} (E96) \approx	5M76	2M94	1M96	1M50	1M21	1M02	866k	768k	698k	619k	[Ω]

RP90Q-xx24SRW

Trim up	1	2	3	4	5	6	7	8	9	10	[%]
$V_{out_set} =$	24.24	24.48	24.72	24.96	25.20	25.44	25.68	25.92	26.16	26.40	[VDC]
R_{up} (E96) \approx	9M53	4M87	3M24	2M94	2M00	1M69	1M47	1M27	1M15	1M05	[Ω]

RP90Q-xx48SRW

Trim up	1	2	3	4	5	6	7	8	9	10	[%]
$V_{out_set} =$	48.48	48.96	49.44	49.92	50.40	50.88	51.36	51.84	52.32	52.80	[VDC]
R_{up} (E96) \approx	19M6	9M945	6M65	5M11	4M12	3M48	3M01	2M61	2M37	2M15	[Ω]

Trim Down all Vout's

Trim down	1	2	3	4	5	6	7	8	9	10	[%]
R_{down} (E96) \approx	499k	243k	162k	118k	90k9	75k	63k4	53k6	46k4	41k2	[Ω]

Trim down	11	12	13	14	15	16	17	18	19	20	[%]
R_{down} (E96) \approx	36k5	32k4	28k7	26k1	23k7	21k5	19k6	18k2	16k5	15k4	[Ω]

Specifications (measured @Ta = 25°C, resistive load, nominal Vin and rated Iout unless otherwise noted)

Remote Sense

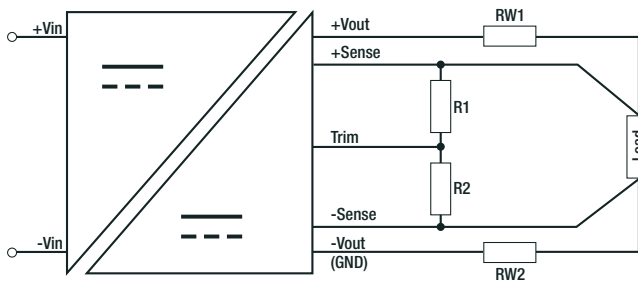

The output voltage can be adjusted by both trim and remote sense. The maximum combined adjustment range $\pm 10\%$. Derate the maximum output power if using the trim or sense function.

- R_{W1} ... wire losses +
- R_{W2} ... wire losses -
- R₁ ... trim up resistor
- R₂ ... trim down resistor

REGULATIONS

Parameter	Condition	Value
Output Accuracy		$\pm 1.0\%$
Line Regulation	low line to high line at full load	$\pm 0.1\%$
Load Regulation	0% to 100% load	5V _{out} others
Transient Response	25% load step change	250 μ s typ.

Transient Response to Dynamic Load Change from 100% to 75% to 100% of Full Load at nom.Vin

RP90Q-2405SRW

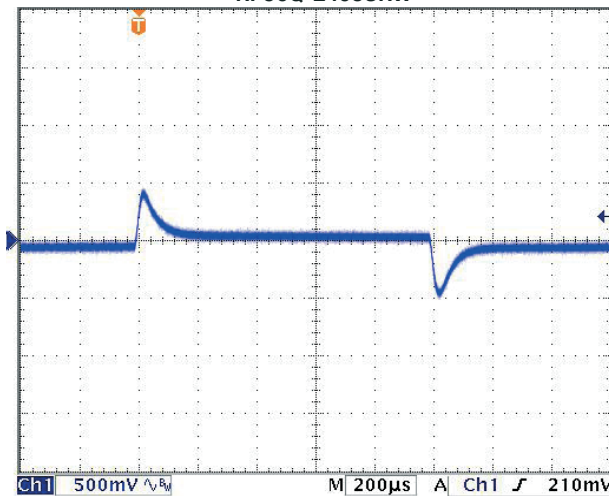

RP90Q-4805SRW

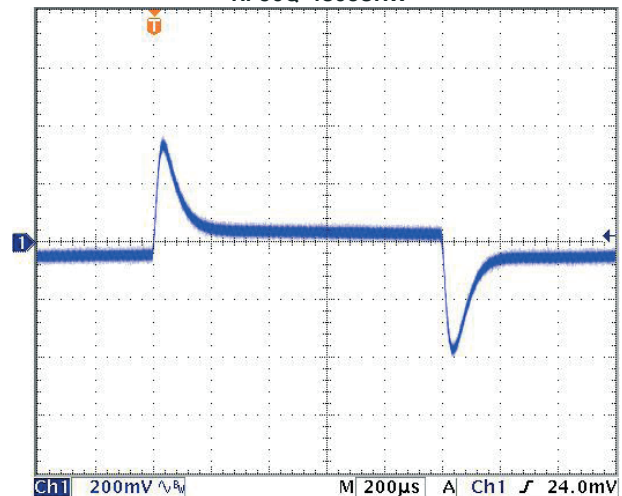

RP90Q-11005SRW

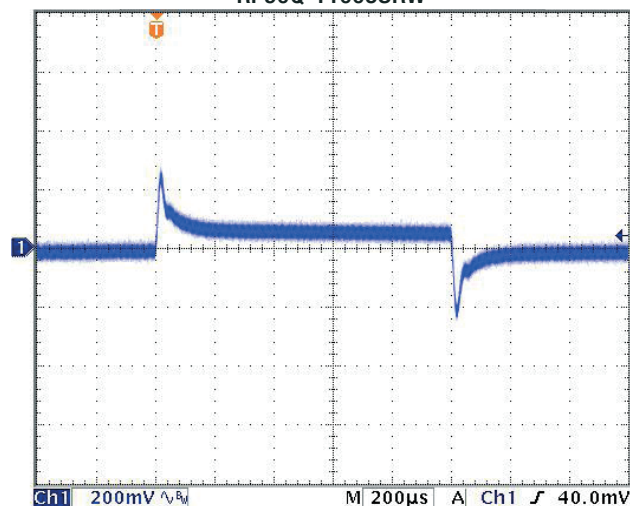

Specifications (measured @Ta = 25°C, resistive load, nominal Vin and rated Iout unless otherwise noted)

PROTECTIONS

Parameter	Condition		Value
Short Circuit Protection (SCP)	below 100mΩ		continuous, automatic recovery
Over Voltage Protection (OVP)	% of nom. Vout		115%-130%, Hiccup Mode
Over Load Protection (OLP)	% Iout rated		110%-140%, Hiccup Mode
Over Temperature Protection (OTP)			+110°C
Isolation Voltage	110Vin	I/P to O/P I/P or O/P to Baseplate	3kVAC/1minute 1.5kVAC/1minute
	24Vin, 48Vin	I/P to O/P I/P or O/P to Baseplate	2.25kVDC/1minute 2.25kVDC/1minute
Isolation Resistance	500 VDC		1GΩ min.
Isolation Capacitance			1500pF max.
Isolation Grade	110Vin		reinforced insulation
	24Vin, 48Vin		basic insulation

Notes:

Note4: Refer to local wiring regulations if input over-current protection is also required. Recommended fuse: T35A slow blow

ENVIRONMENTAL

Parameter	Condition	Value
Operating Baseplate Temperature Range		refer to derating graph
Maximum Case Temperature		100°C
Temperature Coefficient		±0.02%/°C max.
Thermal Impedance	vertical direction by natural convection (0.1m/s) without Heat-sink	9°C/W
	vertical direction by natural convection (0.1m/s) with Heat-sink	7.5°C/W
Operating Humidity		5% - 95% RH
Pollution Degree		PD2
Shock		according to EN61373 standard
Thermal Shock		according to MIL-STD-810F standard
Vibration		according to EN61373 standard
Fire protection on railway vehicles		according to EN45545-2, 2013 standard
MTBF	according to MIL-HDBK-217F standard, 25°C	507.0 x 10 ³ hours

Thermal Calculation

$$R_{th\text{case-ambient}} = 9^\circ\text{C/W (vertical)}$$

$$R_{th\text{case-ambientHC}} = 7.5^\circ\text{C/W (vertical)}$$

$$R_{th\text{case-ambient}} = \frac{T_{\text{case}} - T_{\text{ambient}}}{P_{\text{dissipation}}}$$

$$P_{\text{dissipation}} = P_{\text{IN}} - P_{\text{OUT}} = \frac{P_{\text{OUTapp}}}{\eta} - P_{\text{OUTapp}}$$

- T_{case} = Case Temperature
- T_{ambient} = Environment Temperature
- P_{dissipation} = Internal losses
- P_{IN} = Input Power
- P_{OUT} = Output Power
- η = Efficiency under given Operating Conditions
- R_{thcase-ambient} = Thermal Impedance

Practical Example:

Take the RP90Q-2405SRW with 9V input Voltage and 50% load. What is the maximum ambient operating temperature? Use converter vertical in application without airflow.

$$Eff_{\text{min}} = 89\% @ V_{\text{nom}}$$

$$P_{\text{OUT}} = 90\text{W}$$

$$P_{\text{OUTapp}} = 90 \times 0.5 = 45\text{W}$$

$$\eta = 91\% \text{ (Efficiency vs. Load Graph)}$$

$$P_{\text{dissipation}} = \frac{45}{0.91} - 45 = 4.45\text{W}$$

without Heat-sink

$$R_{th} = \frac{T_{\text{casemax}} - T_{\text{amb}}}{P_{\text{dissipation}}} \rightarrow 9^\circ\text{C/W} = \frac{100 - T_{\text{amb}}}{4.45\text{W}}$$

$$T_{\text{amb}} = 60^\circ\text{C}$$

with Heat-sink

$$R_{thHC} = \frac{T_{\text{casemax}} - T_{\text{amb}}}{P_{\text{dissipation}}} \rightarrow 7.5^\circ\text{C/W} = \frac{100 - T_{\text{amb}}}{4.45\text{W}}$$

$$T_{\text{ambHC}} = 66^\circ\text{C}$$

continued on next page

Specifications (measured @Ta = 25°C, resistive load, nominal Vin and rated Iout unless otherwise noted)

Derating Graph⁽⁵⁾

(@ Chamber - tested with forced convection)

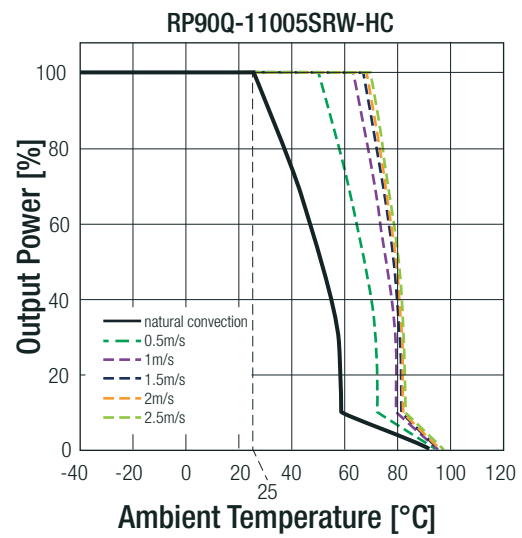
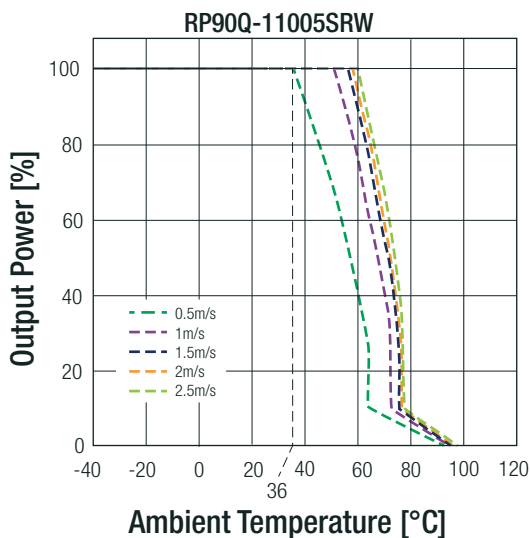
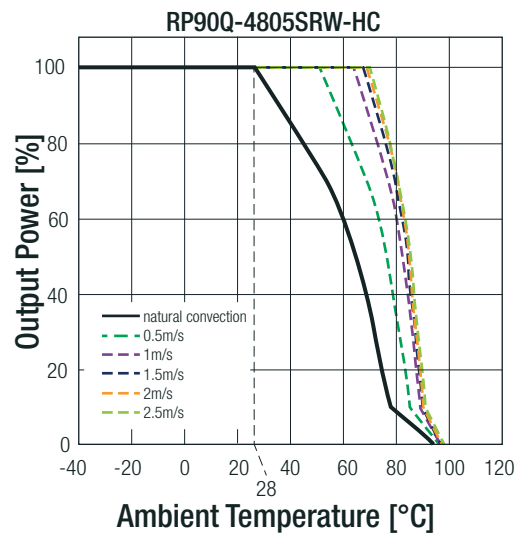
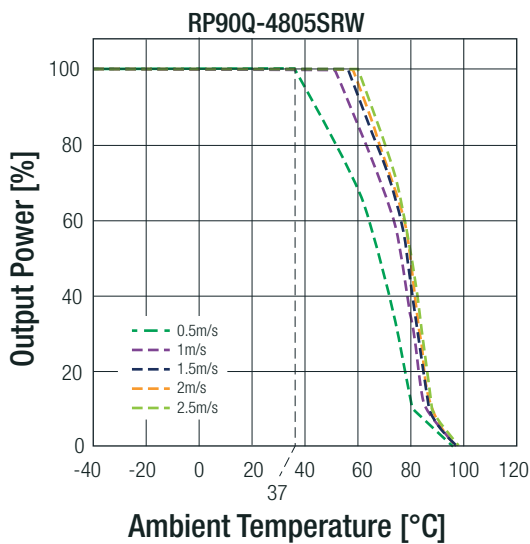
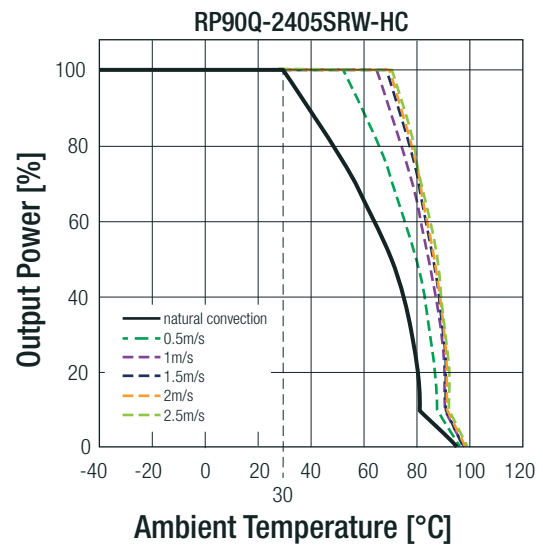
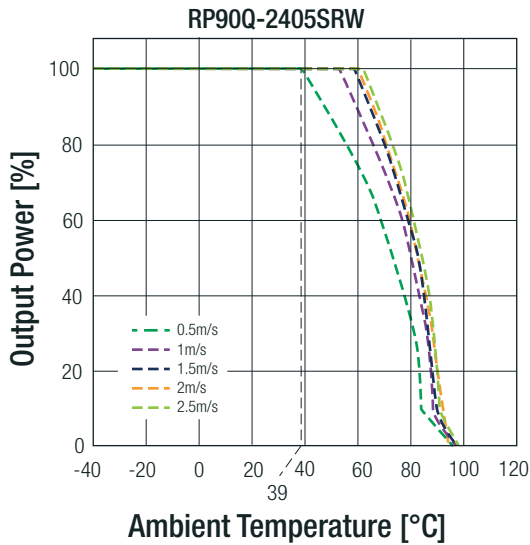

Notes:

Note5: Derating graphs are valid only for the shown part numbers. If you need detailed derating-information about a part-number not shown here please contact our technical support service at techsupport@recom-power.com

Specifications (measured @Ta = 25°C, resistive load, nominal Vin and rated Iout unless otherwise noted)

SAFETY AND CERTIFICATIONS		
Certificate Type (Safety)	Report / File Number	Standard
IEC/EN Information Technology Equipment - General Requirments for Safety	TW1608086-001	IEC60950-1, 2nd Edition, 2005 EN60950-1, 2nd Edition, 2006
Railway Applications - Electrical Equipment used on rolling stock	TW1608078-001	EN50155, 2007
EAC	RU-AT.49.09571	TP TC 004/2011
RoHS 2+		RoHS 2011/65/EU
EMI Compliance	Condition	Standard / Criterion
Information technology equipment - Radio disturbance characteristics - Limits and methods of measurement	with external filter	EN55022, Class A and Class B
Industrial, scientific and medical equipment - Radio frequency disturbance characteristics - Limits and methods of measurement		EN55011, Class A and Class B
ESD Electrostatic discharge immunity test	Air ±8kV and Contact ±6kV 20 V/m ±2kV EN55024 & EN50155 ±2kV 10 Vr.m.s 100A/m continuous; 1000A/m 1s	EN61000-4-2, Criteria A
Radiated, radio-frequency, electromagnetic field immunity test		EN61000-4-3, Criteria A
Fast Transient and Burst Immunity [®]		EN61000-4-4, Criteria A
Surge Immunity [®]		EN61000-4-5, Criteria A
Immunity to conducted disturbances, induced by radio-frequency fields		EN61000-4-6, Criteria A
Power Magnetic Field Immunity		EN61000-4-8, Criteria A

Notes:

Note6: An external input filter capacitor is required if the module has to meet EN61000-4-4 and EN61000-4-5.

The **24Vin** and **48Vin** version recommend 2pcs of aluminium electrolytic capacitor to connect in parallel.
Recom suggest: Nippon Chemi-con KY series, 220µF/100V.

The **110Vin** version recommend 2pcs of aluminium electrolytic capacitor to connect in parallel.
Recom suggest: Nippon Chemi-con KXJ series, 150µF/200V

EMI Filtering according to EN55022/11 Class A and EN50121-1 (24Vin and 48Vin)

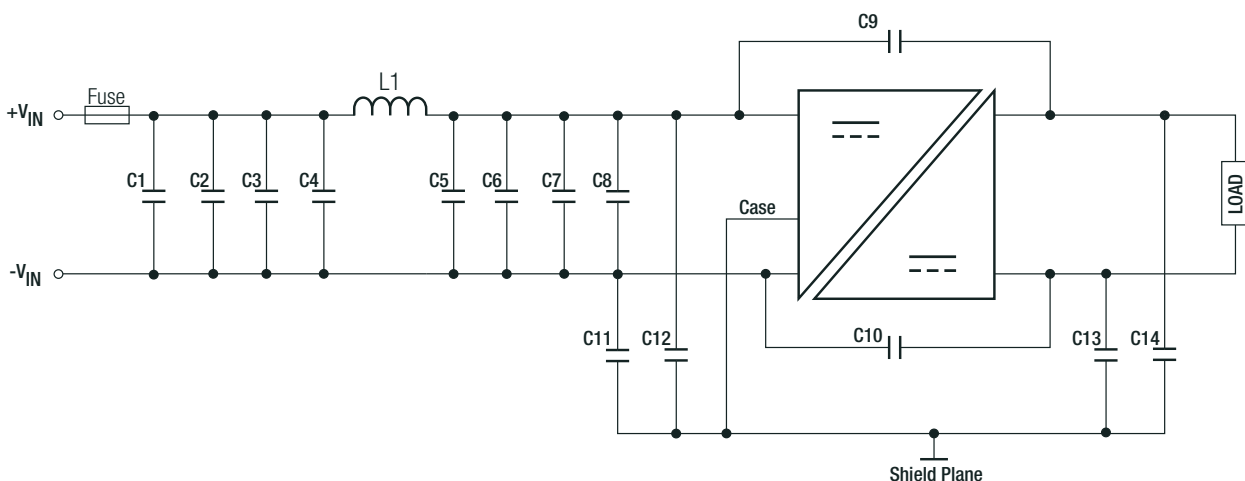

MODEL	C1	C2, C3, C4	C5	C6, C7, C8	C9 to C14	L1
RP90Q-24xxSRW	N/A	6.8µF, 50V 1812 MLCC	N/A	6.8µF, 50V 1812 MLCC	1000pF, 3kV 1808 MLCC	0.68µH, 17A SMD Inductor
RP90Q-48xxSRW	4.7µF, 100V 1812 MLCC	4.7µF, 100V 1812 MLCC	4.7µF, 100V 1812 MLCC	4.7µF, 100V 1812 MLCC	1000pF, 3kV 1808 MLCC	3.3µH, 10A SMD Inductor

continued on next page

Specifications (measured @Ta = 25°C, resistive load, nominal Vin and rated Iout unless otherwise noted)

RP90Q-2405SRW

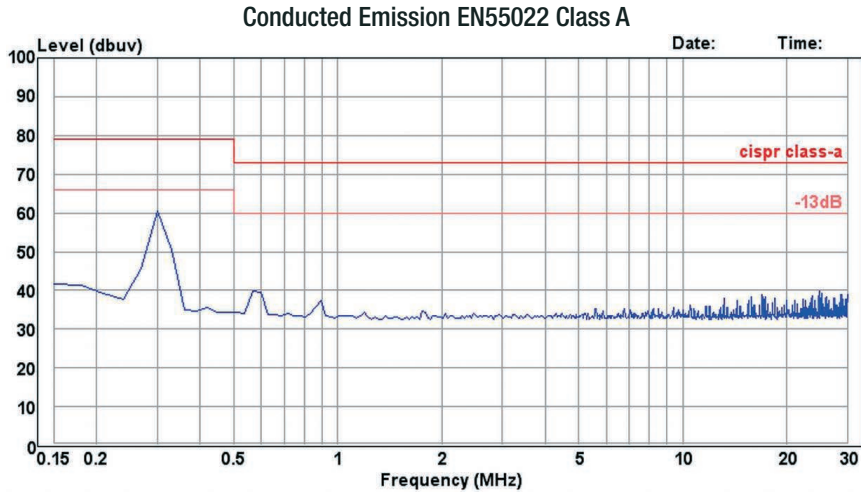

RP90Q-4805SRW

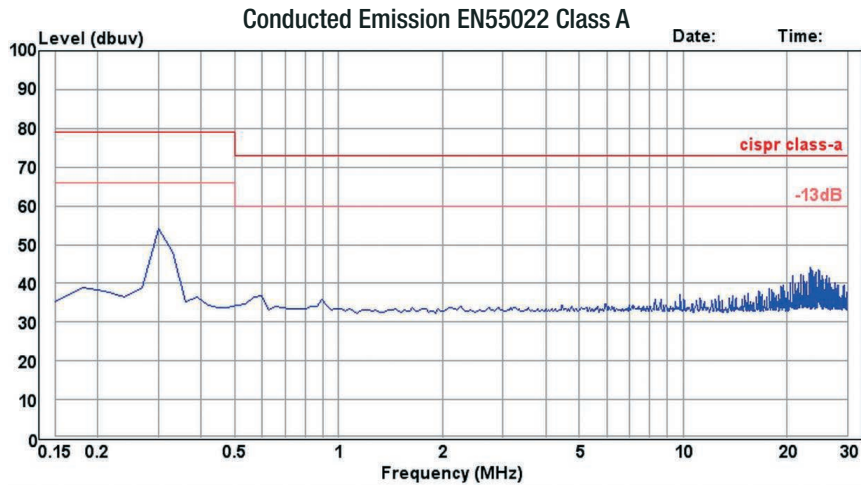

EMI Filtering according to EN55022/11 Class A and EN50121-1 (110Vin)

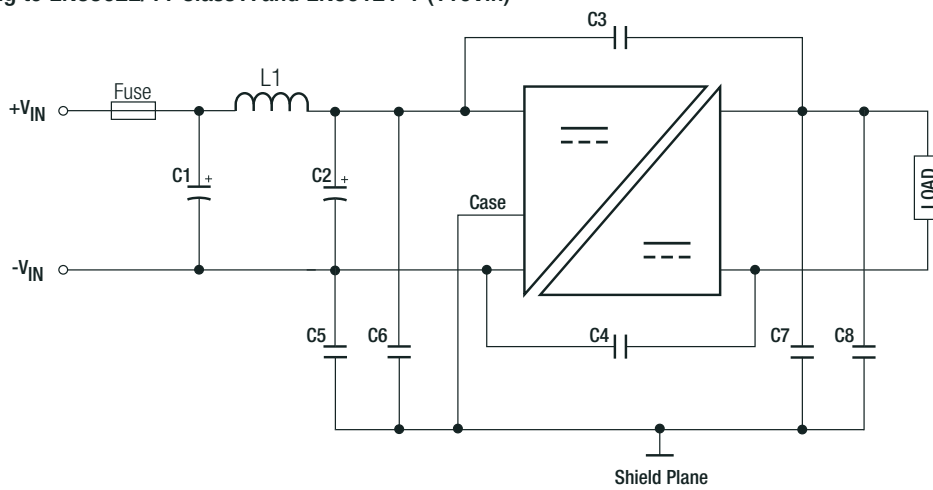

MODEL	C1, C2	C3 to C8	L1
RP90Q-110xxSRW	39µF, 250V Al cap. (lie down) Rubycon BXF	1000pF, 3kV 1808 MLCC	30.1µH, 5A SMD Inductor

continued on next page

Specifications (measured @Ta = 25°C, resistive load, nominal Vin and rated Iout unless otherwise noted)

RP90Q-11005SRW

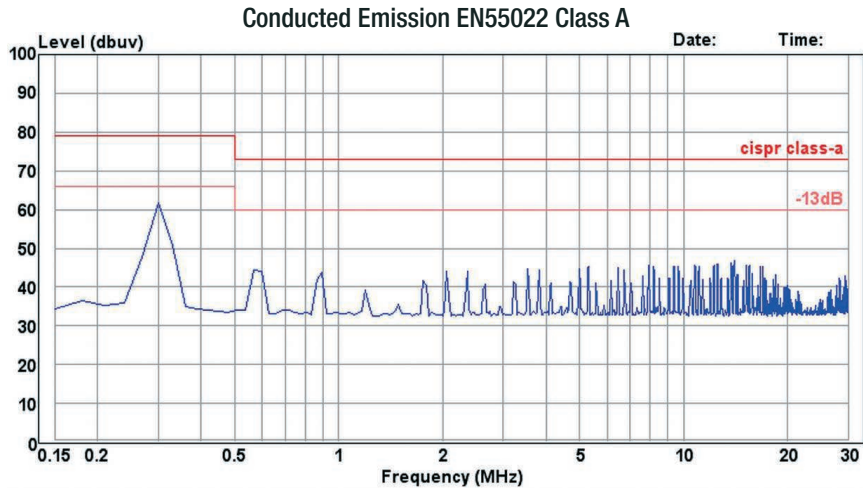

EMI Filtering according to EN55022/11 Class B (24Vin)

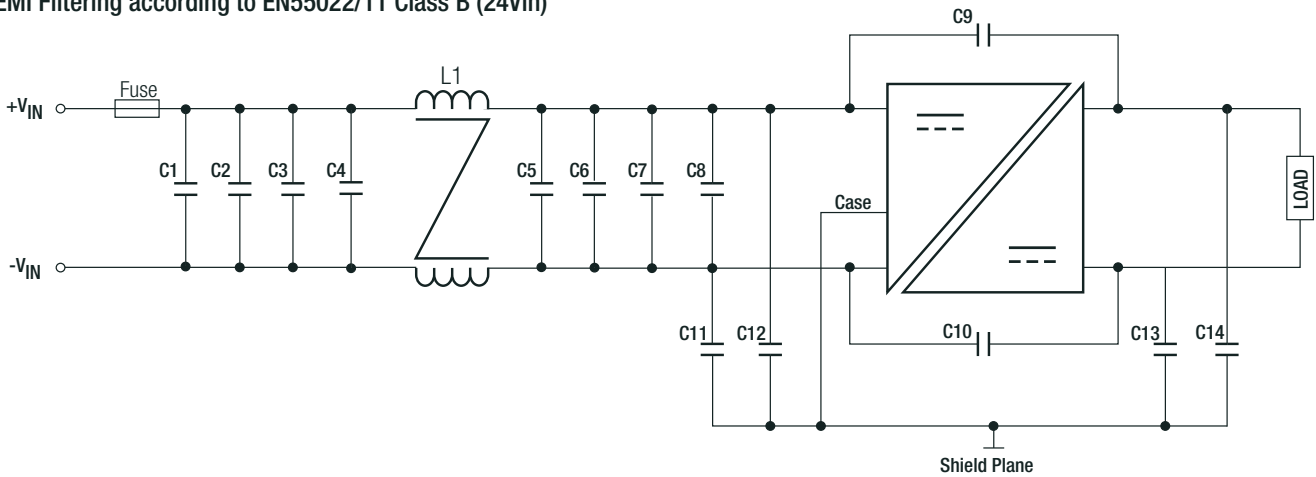

MODEL	C1 to C8	C9, C10, C13, C14	C11, C12	L1
RP90Q-24xxSRW	10μF, 50V 1812 MLCC	1000pF, 3kV 1808 MLCC	2200pF, 3kV 1812 MLCC	285μH CMC

RP90Q-2405SRW

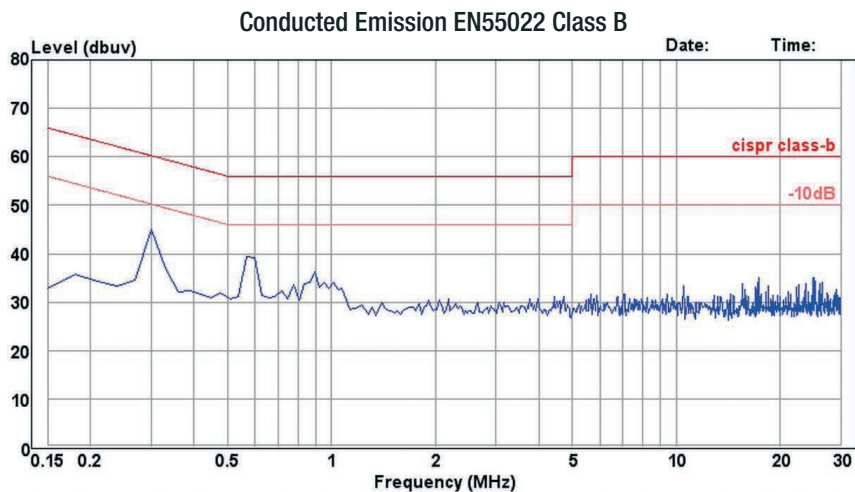

continued on next page

Specifications (measured @Ta = 25°C, resistive load, nominal Vin and rated Iout unless otherwise noted)

EMI Filtering according to EN55022/11 Class B (48Vin)

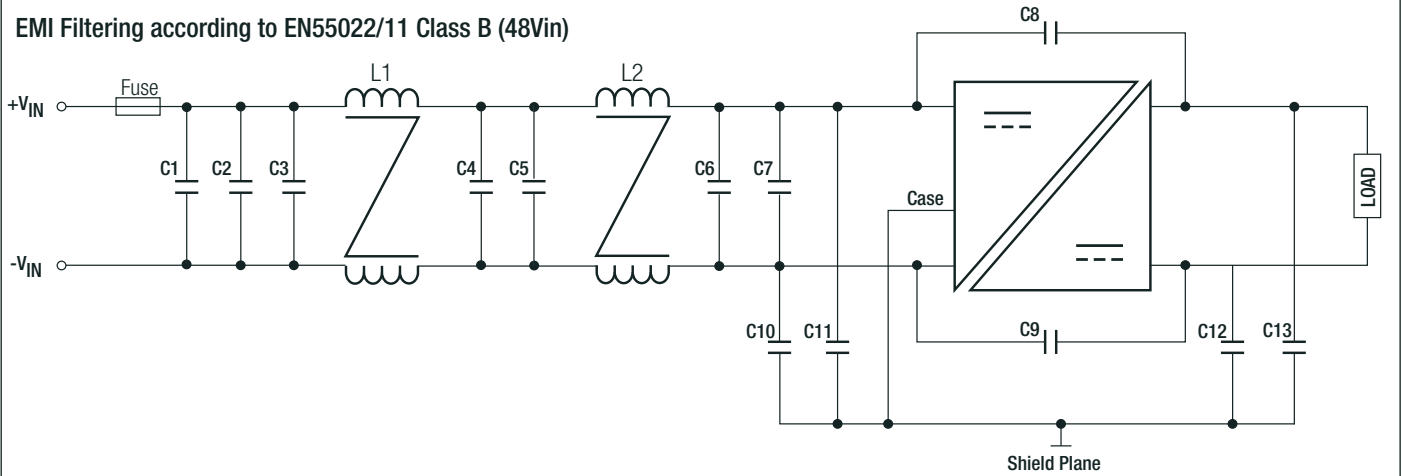

MODEL	C1 to C7	C8 to C13	L1	L2
RP90Q-48xxSRW	4.7µF, 100V 1812 MLCC	1000pF, 3kV 1808 MLCC	620µH CMC	285µH CMC

RP90Q-4805SRW

Conducted Emission EN55022 Class B

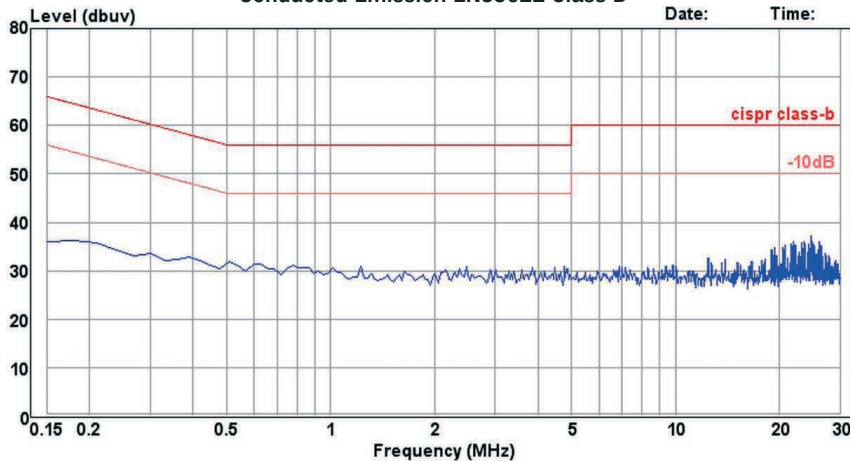

EMI Filtering according to EN55022/11 Class B (110Vin)

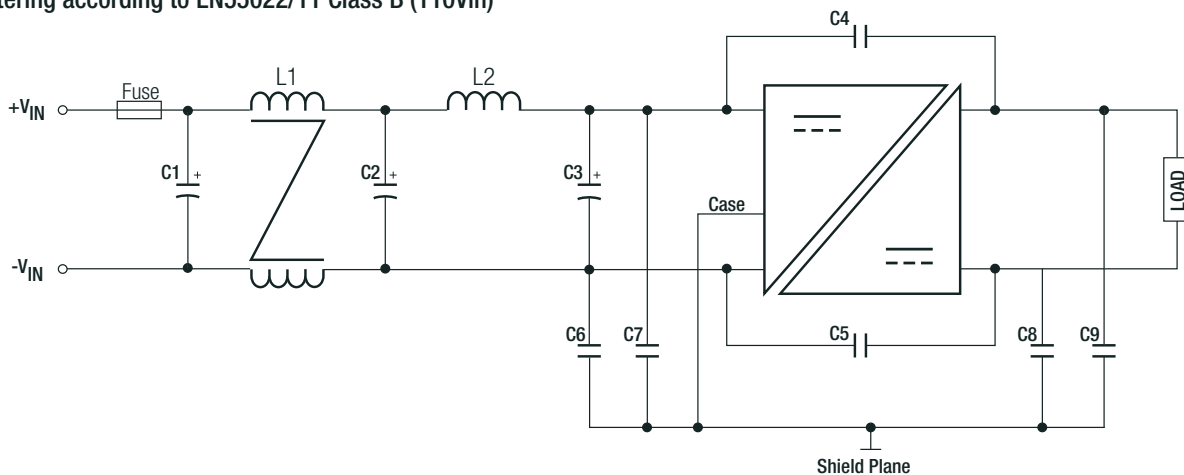

MODEL	C1, C2, C3	C4 to C9	L1	L2
RP90Q-110xxSRW	39µF, 250V Al cap. (lie down) Rubycon BXF	1000pF, 3kV 1808 MLCC	735µH CMC	30.1µH, 5A SMD Inductor

continued on next page

Specifications (measured @Ta = 25°C, resistive load, nominal Vin and rated Iout unless otherwise noted)

RP90Q-110xxSRW

Conducted Emission EN55022 Class B

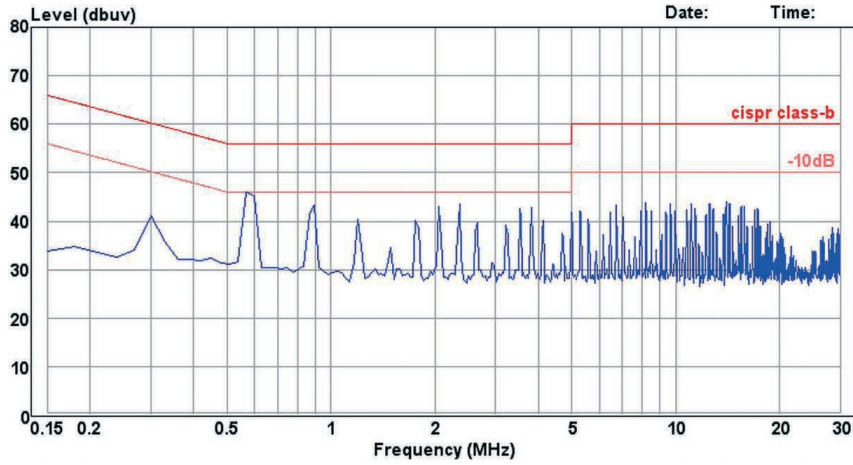

DIMENSIONS and PHYSICAL CHARACTERISTICS

Parameter	Type	Value
Material	Case	Plastic
	Baseplate	Aluminium
	Potting	Silicone (UL94 V-0)
Packaging Dimension (LxWxH)	without Heat-sink	57.9 x 36.6 x 12.7mm
	with Heat-sink	57.9 x 36.6 x 18.8mm
Packaging Weight	without Heat-sink	64g
	with Heat-sink	88g

Dimension Drawing (mm)
Heat-sink

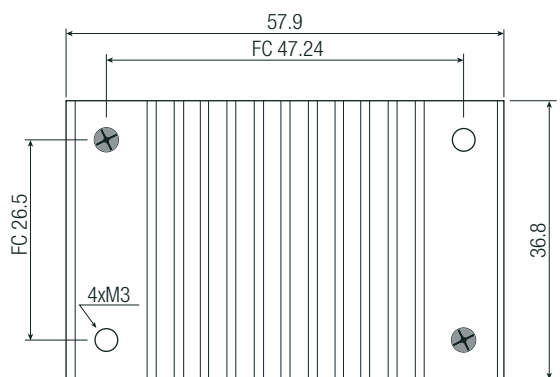
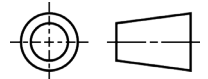

Notes:

Note7: Max. tightening torque for Heat-sink: 0.34Nm

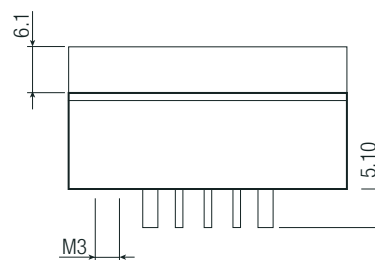
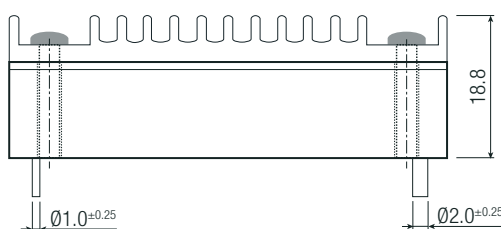

continued on next page

Specifications (measured @Ta = 25°C, resistive load, nominal Vin and rated Iout unless otherwise noted)

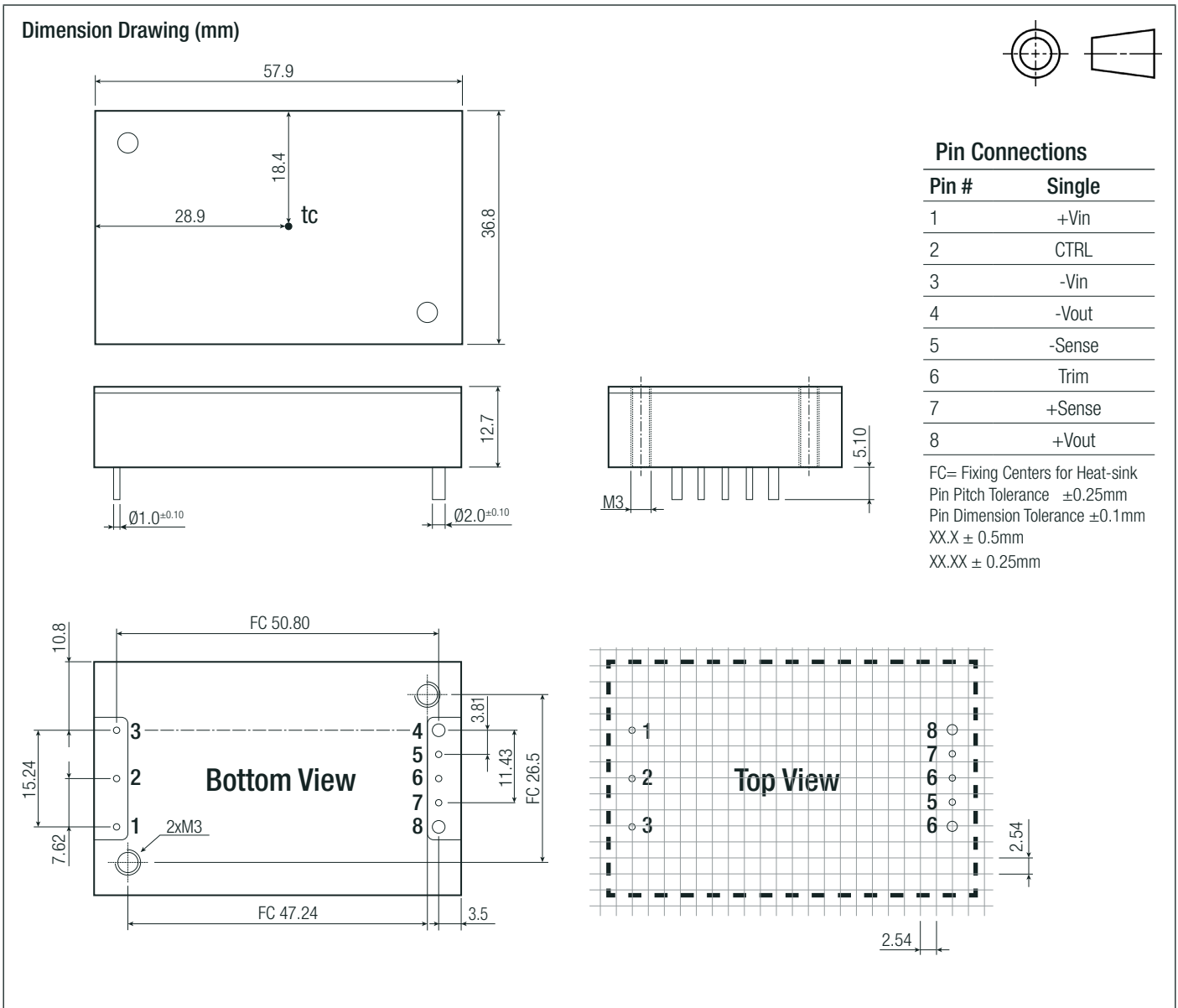

PACKAGING INFORMATION			
Parameter	Type		Value
Packaging Dimension	tray	without Heat-sink	157.0 x 88.0 x 12.8mm
		with Heat-sink	157.0 x 88.0 x 24.8mm
Packaging Quantity			2pcs
Storage Temperature Range			-55°C to +125°C
Storage Humidity			5% - 95% RH

The product information and specifications may be subject to changes even without prior written notice. The product has been designed for various applications; its suitability lies in the responsibility of each customer. The products are not authorized for use in safety-critical applications without RECOM's explicit written consent. A safety-critical application is an application where a failure may reasonably be expected to endanger or cause loss of life, inflict bodily harm or damage property. The applicant shall indemnify and hold harmless RECOM, its affiliated companies and its representatives against any damage claims in connection with the unauthorized use of RECOM products in such safety-critical applications.



Компания «ЭлектроПласт» предлагает заключение долгосрочных отношений при поставках импортных электронных компонентов на взаимовыгодных условиях!

Наши преимущества:

- Оперативные поставки широкого спектра электронных компонентов отечественного и импортного производства напрямую от производителей и с крупнейших мировых складов;
- Поставка более 17-ти миллионов наименований электронных компонентов;
- Поставка сложных, дефицитных, либо снятых с производства позиций;
- Оперативные сроки поставки под заказ (от 5 рабочих дней);
- Экспресс доставка в любую точку России;
- Техническая поддержка проекта, помощь в подборе аналогов, поставка прототипов;
- Система менеджмента качества сертифицирована по Международному стандарту ISO 9001;
- Лицензия ФСБ на осуществление работ с использованием сведений, составляющих государственную тайну;
- Поставка специализированных компонентов (Xilinx, Altera, Analog Devices, Intersil, Interpoint, Microsemi, Aeroflex, Peregrine, Syfer, Eurofarad, Texas Instrument, Miteq, Cobham, E2V, MA-COM, Hittite, Mini-Circuits, General Dynamics и др.);

Помимо этого, одним из направлений компании «ЭлектроПласт» является направление «Источники питания». Мы предлагаем Вам помощь Конструкторского отдела:

- Подбор оптимального решения, техническое обоснование при выборе компонента;
- Подбор аналогов;
- Консультации по применению компонента;
- Поставка образцов и прототипов;
- Техническая поддержка проекта;
- Защита от снятия компонента с производства.



Как с нами связаться

Телефон: 8 (812) 309 58 32 (многоканальный)

Факс: 8 (812) 320-02-42

Электронная почта: org@eplast1.ru

Адрес: 198099, г. Санкт-Петербург, ул. Калинина, дом 2, корпус 4, литера А.