

## Watchdog Timeout Period Externally Adjustable Voltage Detector

## ■ GENERAL DESCRIPTION

The XC6130/XC6131 series are voltage detectors with a watchdog function. The watchdog timeout time and release delay time can be set as desired using a single external capacitor. These voltage detectors are used for microprocessor monitoring, and when the power voltage reaches the detect voltage or an L→H pulse is not input to the watchdog pin within the watchdog timeout time, an L level signal is output from the RESETB pin.

The XC6130 series has a manual reset function. When the manual reset pin is set to Low level at any desired timing, an L level signal is output from the RESETB pin.

The XC6131 series has a watchdog ON/OFF function. By setting the EN pin to L level, the watchdog function can be turned OFF while the voltage detector that monitors the power voltage continues to operate.

The MRB pin and EN pin are pulled up internally to  $V_{IN}$ , and thus these pins can be left open when not used.

## ■ APPLICATIONS

- Microprocessor reset and malfunction monitoring circuitry
- Memory battery backup circuits
- Power-on reset circuits
- Power failure detection

## ■ FEATURES

<b>Operating Ambient Temperature</b>	: -40°C~+125°C
<b>Operating Voltage Range</b>	: 1.5V~6.0V
<b>Detect Voltage Range</b>	: 1.6V~5.0V ( $\pm 1.0\%$ )
<b>Hysteresis Width</b>	: $V_{DFL} \times 5\%$
<b>Temperature Characteristics</b>	: $\pm 50\text{ppm}/^\circ\text{C}$
<b>Output Configuration</b>	: N-channel open drain output
<b>Low Power Consumption</b>	: 8.1 $\mu\text{A}$ Detect 9.8 $\mu\text{A}$ Release 2.5 $\mu\text{A}$ Release (EN=L)
<b>Function</b>	: Manual Reset (XC6130) : Watchdog function OFF (XC6131)
<b>WD Timeout Time</b>	: 100ms (Cd=0.1 $\mu\text{F}$ )
<b>Release Delay Time</b>	: 100ms (Cd=0.1 $\mu\text{F}$ ) (at power on) 10ms (Cd=0.1 $\mu\text{F}$ ) (After Watchdog Timeout)
<b>Package</b>	: SOT-26
<b>Environmentally Friendly</b>	: EU RoHS compliant, Pb free

## ■ TYPICAL APPLICATION CIRCUIT



## ■ TYPICAL PERFORMANCE CHARACTERISTICS



\* The above values do not include the current that flows to the EN pull-up resistance.

# XC6130/XC6131 Series

## ■ BLOCK DIAGRAM

● XC6130 Series Type A



● XC6131 Series Type A



\* Diodes inside the circuit are an ESD protection diode and a parasitic diode.

■ BLOCK DIAGRAM

● XC6131 Series Type B



\* Diodes inside the circuit are an ESD protection diode and a parasitic diode.

## ■ PRODUCT CLASSIFICATION

### ● Ordering Information

#### XC6130①②③④⑤⑥-⑦

DESIGNATOR	ITEM	SYMBOL	DESCRIPTION
①	TYPE	A	MRB pin With pull-up resistor
②③	Detect Voltage	16~50	e.g. 1.6V → ②=1, ③=6
④	Detect Accuracy	1	±1.0%
⑤⑥-⑦ (*1)	Package (Order Unit)	MR-G	SOT-26 (3000pcs/Reel)(*2)

(\*1) The "-G" suffix denotes Halogen and Antimony free as well as being fully EU RoHS compliant.

(\*2) The SOT-26 reels are shipped in a moisture-proof packing.

#### XC6131①②③④⑤⑥-⑦

DESIGNATOR	ITEM	SYMBOL	DESCRIPTION
①	TYPE	A	EN pin With pull up resistor
		B	ENB pin With pull down resistor
②③	Detect Voltage	16~50	e.g. 1.6V → ②=1, ③=6
④	Detect Accuracy	1	±1.0%
⑤⑥-⑦ (*1)	Package (Order Unit)	MR-G	SOT-26 (3000pcs/Reel)(*2)

(\*1) The "-G" suffix denotes Halogen and Antimony free as well as being fully EU RoHS compliant.

(\*2) The SOT-26 reels are shipped in a moisture-proof packing.

]

## ■ PIN CONFIGURATION



SOT-26  
(TOP VIEW)

XC6130 series



SOT-26  
(TOP VIEW)

XC6131 series

## ■ PIN ASSIGNMENT

### XC6130 Series

PIN NUMBER	PIN NAME	FUNCTIONS
SOT-26		
1	WD	Watchdog Input
2	MRB	Manual Reset Input
3	V <sub>IN</sub>	Power Input
4	RESETB	Reset Output
5	V <sub>SS</sub>	Ground
6	Cd	Adjustable Pin for Release Delay Time/Watchdog Timeout

### XC6131 Series

PIN NUMBER	PIN NAME	FUNCTIONS
SOT-26		
1	WD	Watchdog Input
2	EN	Watchdog ON/OFF Control (XC6131A)
	ENB	Watchdog ON/OFF Control (XC6131B)
3	V <sub>IN</sub>	Power Input
4	RESETB	Reset Output
5	V <sub>SS</sub>	Ground
6	Cd	Adjustable Pin for Release Delay Time/Watchdog Timeout

## FUNCTION CHART

### 1) XC6130 Series

$V_{IN}^{*2}$	$V_{MRB}^{*3}$	$V_{WD}^{*6}$	$V_{RESETB}^{*7}$
H	H	H	L↔H
		L	
		OPEN	
		L↔H	H
H	L	*1	L
L	L		
H	L		

### 2) XC6131A Series

$V_{IN}^{*2}$	$V_{EN}^{*4}$	$V_{WD}^{*6}$	$V_{RESETB}^{*7}$
H	H	H	L↔H
		L	
		OPEN	
		L↔H	H
H	L	*1	H
L	L		
H	L		

### 3) XC6131B Series

$V_{IN}^{*2}$	$V_{ENB}^{*5}$	$V_{WD}^{*6}$	$V_{RESETB}^{*7}$
H	L	H	L↔H
		L	
		OPEN	
		L↔H	H
H	H	*1	H
L	L		
H	L		

\*1: Includes all WD logic ( $V_{WD}=H, L, OPEN, H \rightarrow L, L \rightarrow H$ )

\*2:  $V_{IN}=H$  indicates higher than the release voltage.

$V_{IN}=L$  indicates lower than the detect voltage.

\*3:  $V_{MRB}=H$  indicates MRB High Level Voltage.

$V_{MRB}=L$  indicates MRB Low Level Voltage.

Since MRB pin of XC6130 Series is pulled up internally, the open condition of MRB pin is acceptable when MR function is not required.

\*4:  $V_{EN}=H$  indicates EN High Level Voltage.

$V_{EN}=L$  indicates EN Low Level Voltage.

The EN pin of the XC6131A Series is pulled up internally, enabling the WD function to be used with EN open.

\*5:  $V_{ENB}=H$  indicates ENB High Level Voltage.

$V_{ENB}=L$  indicates ENB Low Level Voltage.

The ENB pin of the XC6131B Series is pulled down internally, enabling the WD function to be used with ENB open.

\*6:  $V_{WD}=H$  indicates WD High Level Voltage.

$V_{WD}=L$  indicates WD Low Level Voltage.

\*7:  $V_{RESETB}=H$  indicates the release state.

$V_{RESETB}=L$  indicates the detect state.

## ■ ABSOLUTE MAXIMUM RATINGS

XC6130 Series

Ta=25°C

PARAMETER		SYMBOL	RATINGS	UNITS
Input Voltage		V <sub>IN</sub>	-0.3~+7.0	V
WD Input Voltage		V <sub>WD</sub>	-0.3~+7.0	V
MRB Input Voltage		V <sub>MRB</sub>	-0.3~+7.0	V
Cd Pin Voltage		V <sub>Cd</sub>	-0.3~+V <sub>IN</sub> +0.3 or +7.0 <sup>(*)</sup>	V
Output Voltage		V <sub>RESETB</sub>	-0.3~+7.0	V
Cd Pin Current		I <sub>Cd</sub>	10	mA
Output Current		I <sub>OUT</sub>	30	mA
Power Dissipation	SOT-26	P <sub>d</sub>	250	mW
Operating Ambient Temperature		T <sub>opr</sub>	-40~+125	°C
Storage Temperature		T <sub>stg</sub>	-55~+125	°C

All voltages are described based on the V<sub>SS</sub> pin.

(\*) The maximum value should be V<sub>IN</sub>+0.3 or +7.0 in the lowest.

XC6131 Series

Ta=25°C

PARAMETER		SYMBOL	RATINGS	UNITS
Input Voltage		V <sub>IN</sub>	-0.3~+7.0	V
WD Input Voltage		V <sub>WD</sub>	-0.3~+7.0	V
EN/ENB Input Voltage		V <sub>EN</sub> /V <sub>ENB</sub>	-0.3~+7.0	V
Cd Pin Voltage		V <sub>Cd</sub>	-0.3~+V <sub>IN</sub> +0.3 or +7.0 <sup>(*)</sup>	V
Output Voltage		V <sub>RESETB</sub>	-0.3~+7.0	V
Cd Pin Current		I <sub>Cd</sub>	10	mA
Output Current		I <sub>OUT</sub>	30	mA
Power Dissipation	SOT-26	P <sub>d</sub>	250	mW
Operating Ambient Temperature		T <sub>opr</sub>	-40~+125	°C
Storage Temperature		T <sub>stg</sub>	-55~+125	°C

All voltages are described based on the V<sub>SS</sub> pin.

(\*) The maximum value should be V<sub>IN</sub>+0.3 or +7.0 in the lowest.

## ELECTRICAL CHARACTERISTICS

XC6130 Series

PARAMETER	SYMBOL	CONDITIONS	Ta=25°C			-40°C ≤ Ta ≤ 125°C <sup>(9)</sup>			UNITS	CIRCUIT	
			MIN.	TYP.	MAX.	MIN.	TYP.	MAX.			
Operating Voltage	V <sub>IN</sub>		1.5	-	6.0	1.5	-	6.0	V	①	
Detect Voltage	V <sub>DFL</sub>	V <sub>DF(T)</sub> <sup>(1)</sup> =1.6~5.0V	V <sub>DF(T)</sub> ×0.99	V <sub>DF(T)</sub>	V <sub>DF(T)</sub> ×1.01	V <sub>DF(T)</sub> ×0.975	V <sub>DF(T)</sub>	V <sub>DF(T)</sub> ×1.025	V		
Temperature Characteristics	$\frac{\Delta V_{DFL}}{(\Delta T_{opr} \cdot V_{DFL})}$	-40°C ≤ Topr ≤ 125°C	-	±50	-	-	±50	-	ppm/°C		
Hysteresis Width	V <sub>HYS</sub>		V <sub>DFL</sub> ×0.04	V <sub>DFL</sub> ×0.05	V <sub>DFL</sub> ×0.06	V <sub>DFL</sub> ×0.03	V <sub>DFL</sub> ×0.05	V <sub>DFL</sub> ×0.07	V		
Supply Current	I <sub>SS</sub>	V <sub>IN</sub> =V <sub>DF(T)</sub> × 0.9V	-	8.1	12.1	-	8.1	14.0	μA	②	
		V <sub>IN</sub> =V <sub>DF(T)</sub> × 1.1V	-	9.8	12.6	-	9.8	13.6			
Output Current	I <sub>RBOU</sub> T	N-ch. V <sub>RESE</sub> TB=0.3V	V <sub>IN</sub> =1.5V	2.6	3.5	-	1.4	3.5	-	mA	③
			V <sub>IN</sub> =2.0V <sup>(2)</sup>	4.9	6.0	-	3.0	6.0	-		
			V <sub>IN</sub> =3.0V <sup>(3)</sup>	9.2	10.3	-	5.8	10.3	-		
			V <sub>IN</sub> =4.0V <sup>(4)</sup>	12.3	13.8	-	7.7	13.8	-		
Leak Current	I <sub>Leak</sub>	V <sub>IN</sub> =6.0V, V <sub>RESE</sub> TB=6.0	-	0.01	0.1	-	0.01	1	μA	④	
Cd Pin Sink Current	I <sub>cd</sub>	V <sub>IN</sub> =1.5V, V <sub>Cd</sub> =0.7V	530	770	-	295	770	-			
Release Delay Time1 <sup>(5)</sup>	t <sub>DR1</sub>	V <sub>IN</sub> =1.5V → V <sub>DF(T)</sub> × 1.1V, Cd=0.01μF	8.5	10.0	11.5	7	10.0	12	ms	⑤	
Release Delay Time2 <sup>(6)</sup>	t <sub>DR2</sub>	V <sub>IN</sub> =V <sub>DF(T)</sub> × 1.1V, Cd=0.01μF	0.85	1.0	1.15	0.7	1.0	1.2			
Watchdog Timeout Period <sup>(7)</sup>	t <sub>WD</sub>	V <sub>IN</sub> =V <sub>DF(T)</sub> × 1.1V, Cd=0.01μF, WD=V <sub>SS</sub>	8.5	10.0	11.5	7	10.0	12			
Detect Delay Time <sup>(8)</sup>	t <sub>DF</sub>	V <sub>IN</sub> =V <sub>DF(T)</sub> × 1.1V → 1.5V, Cd=0.01μF	-	10.0	50	-	10.0	100	μs		
Watchdog Minimum Pulse Width	t <sub>WDIN</sub>	V <sub>IN</sub> =6.0V, Apply pulse from 6.0V to 0V to the WD pin.	100	-	-	100	-	-	ns	⑥	
Watchdog High Level Voltage	V <sub>WDH</sub>	V <sub>IN</sub> =V <sub>DF(T)</sub> × 1.1V → 6.0V	V <sub>IN</sub> × 0.7	-	6	V <sub>IN</sub> × 0.7	-	6	V		
Watchdog Low Level Voltage	V <sub>WDL</sub>	V <sub>IN</sub> =V <sub>DF(T)</sub> × 1.1V → 6.0V	0	-	V <sub>IN</sub> × 0.3	0	-	V <sub>IN</sub> × 0.3	V		
Watchdog Pull-down Resistance	R <sub>WD</sub>	V <sub>WD</sub> =6.0V, R <sub>WD</sub> =V <sub>WD</sub> /I <sub>WD</sub>	280	550	1100	220	550	1350	kΩ	⑦	
MRB High Level Voltage	V <sub>MRH</sub>	V <sub>IN</sub> =V <sub>DF(T)</sub> × 1.1V ~ 6.0V	1.3	-	V <sub>IN</sub>	1.3	-	V <sub>IN</sub>	V	⑧	
MRB Low Level Voltage	V <sub>MRL</sub>		0	-	0.45	0	-	0.45	V		
MRB Pull-up Resistance	R <sub>MR</sub>	V <sub>IN</sub> =6.0V, V <sub>MRB</sub> =0V, R <sub>MR</sub> =V <sub>IN</sub> /I <sub>MRB</sub>	300	800	1200	230	800	1420	kΩ	⑨	
MRB Minimum Pulse Width	t <sub>MRIN</sub>	V <sub>IN</sub> =6.0V, Apply pulse from 6.0V to 0V to the MRB pin.	1.0	-	-	1.0	-	-	μs	⑩	

NOTE:

\*The WD pin and MRB pin are open unless otherwise specified in the measurement conditions.

<sup>(1)</sup> V<sub>DF(T)</sub>: Nominal detect voltage

<sup>(2)</sup> For V<sub>DF(T)</sub> > 2.0V products only.

<sup>(3)</sup> For V<sub>DF(T)</sub> > 3.0V products only.

<sup>(4)</sup> For V<sub>DF(T)</sub> > 4.0V products only.

<sup>(5)</sup> Until time when RESETB pin shows release status after V<sub>IN</sub> reached the release voltage.

Release voltage (V<sub>DR</sub>) = Detect voltage (V<sub>DFL</sub>) + Hysteresis width (V<sub>HYS</sub>)

<sup>(6)</sup> The time to change the status of RESETB pin from the detect-status after the watchdog-timeout happens with the condition of WD=V<sub>SS</sub>.

<sup>(7)</sup> The time to change the status of RESETB pin from the release-status to the detect-status with the condition of WD=V<sub>SS</sub>.

<sup>(8)</sup> When V<sub>IN</sub> is changed during watchdog timeout time, until time when RESETB pin shows detect status after V<sub>IN</sub> reached the detect voltage.

<sup>(9)</sup> The ambient temperature range (-40°C ≤ Ta ≤ 125°C) is design Value.



## ELECTRICAL CHARACTERISTICS (Continued)

XC6131A Series

PARAMETER	SYMBOL	CONDITIONS	Ta=25°C			-40°C ≤ Ta ≤ 125°C <sup>(10)</sup>			UNITS	CIRCUIT	
			MIN.	TYP.	MAX.	MIN.	TYP.	MAX.			
Operating Voltage	V <sub>IN</sub>		1.5	-	6.0	1.5	-	6.0	V	①	
Detect Voltage	V <sub>DFL</sub>	V <sub>DF(T)</sub> <sup>(1)</sup> =1.6~5.0V	V <sub>DF(T)</sub> ×0.99	V <sub>DF(T)</sub>	V <sub>DF(T)</sub> ×1.01	V <sub>DF(T)</sub> ×0.975	V <sub>DF(T)</sub>	V <sub>DF(T)</sub> ×1.025	V		
Temperature Characteristics	$\frac{\Delta V_{DFL}}{(\Delta T_{opr} \cdot V_{DFL})}$	-40°C ≤ T <sub>opr</sub> ≤ 125°C	-	±50	-	-	±50	-	ppm/°C		
Hysteresis Width	V <sub>HYS</sub>		V <sub>DFL</sub> ×0.04	V <sub>DFL</sub> ×0.05	V <sub>DFL</sub> ×0.06	V <sub>DFL</sub> ×0.03	V <sub>DFL</sub> ×0.05	V <sub>DFL</sub> ×0.07	V		
Supply Current	I <sub>SS</sub>	V <sub>IN</sub> =V <sub>DF(T)</sub> × 0.9V	-	8.1	12.1	-	8.1	14.0	μA	②	
		V <sub>IN</sub> =V <sub>DF(T)</sub> × 1.1V	EN=L <sup>(2)</sup>	-	2.5	3.5	-	2.5			5.0
			EN=H	-	9.8	12.6	-	9.8			13.6
Output Current	I <sub>RBOU</sub> T	N-ch. V <sub>RESE</sub> TB=0.3V	V <sub>IN</sub> =1.5V	2.6	3.5	-	1.4	3.5	mA	③	
			V <sub>IN</sub> =2.0V <sup>(2)</sup>	4.9	6.0	-	3.0	6.0			
			V <sub>IN</sub> =3.0V <sup>(3)</sup>	9.2	10.3	-	5.8	10.3			
			V <sub>IN</sub> =4.0V <sup>(4)</sup>	12.3	13.8	-	7.7	13.8			
Leakage Current	I <sub>Leak</sub>	V <sub>IN</sub> =6.0V, V <sub>RESE</sub> TB=6.0V	-	0.01	0.1	-	0.01		μA	④	
Cd Pin Sink Current	I <sub>cd</sub>	V <sub>IN</sub> =1.5V, V <sub>Cd</sub> =0.7V	530	770	-	295	770	-			
Release Delay Time1 <sup>(6)</sup>	t <sub>DR1</sub>	V <sub>IN</sub> =1.5V → V <sub>DF(T)</sub> × 1.1V, Cd=0.01μF	8.5	10.0	11.5	7	10.0	12	ms	⑤	
Release Delay Time2 <sup>(7)</sup>	t <sub>DR2</sub>	V <sub>IN</sub> =V <sub>DF(T)</sub> × 1.1V, Cd=0.01μF	0.85	1.0	1.15	0.7	1.0	1.2			
Watchdog Timeout Period <sup>(8)</sup>	t <sub>WD</sub>	V <sub>IN</sub> =V <sub>DF(T)</sub> × 1.1V, Cd=0.01μF, WD=V <sub>SS</sub>	8.5	10.0	11.5	7	10.0	12			
Detect Delay Time <sup>(9)</sup>	t <sub>DF</sub>	V <sub>IN</sub> =V <sub>DF(T)</sub> × 1.1V → 1.5V, Cd=0.01μF	-	10.0	50	-	10.0	100	μs		
Watchdog Minimum Pulse Width	t <sub>WDIN</sub>	V <sub>IN</sub> =6.0V, Apply pulse from 6.0V to 0V to the WD pin.	100	-	-	100	-	-	ns	⑥	
Watchdog High Level Voltage	V <sub>WDH</sub>	V <sub>DF(T)</sub> × 1.1V ≤ V <sub>IN</sub> ≤ 6.0V	V <sub>IN</sub> × 0.7	-	6	V <sub>IN</sub> × 0.7	-	6	V		
Watchdog Low Level Voltage	V <sub>WDL</sub>	V <sub>DF(T)</sub> × 1.1V ≤ V <sub>IN</sub> ≤ 6.0V	0	-	V <sub>IN</sub> × 0.3	0	-	V <sub>IN</sub> × 0.3	V		
Watchdog Pull-down Resistance	R <sub>WD</sub>	V <sub>WD</sub> =6.0V, R <sub>WD</sub> =V <sub>WD</sub> /I <sub>WD</sub>	280	550	1100	220	550	1350	kΩ	⑦	
EN High Level Voltage	V <sub>ENH</sub>	V <sub>IN</sub> =V <sub>DF(T)</sub> × 1.1V ~ 6.0V	1.3	-	V <sub>IN</sub>	1.3	-	V <sub>IN</sub>	V	⑧	
EN Low Level Voltage	V <sub>ENL</sub>		0	-	0.45	0	-	0.45	V	⑨	
EN Pull-up Resistance	R <sub>EN</sub>	V <sub>IN</sub> =6.0V, V <sub>EN</sub> =0V, R <sub>EN</sub> =V <sub>IN</sub> /I <sub>EN</sub>	300	800	1200	230	800	1420	kΩ		

NOTE:

\* The WD pin and EN pin are open unless otherwise specified in the measurement conditions.

<sup>(1)</sup> V<sub>DF(T)</sub>: Nominal detect voltage

<sup>(2)</sup> Excludes the current that flows to EN pull-up resistance when EN = L.

<sup>(3)</sup> For V<sub>DF(T)</sub> > 2.0V products only.

<sup>(4)</sup> For V<sub>DF(T)</sub> > 3.0V products only.

<sup>(5)</sup> For V<sub>DF(T)</sub> > 4.0V products only.

<sup>(6)</sup> Until time when RESETB pin shows release status after V<sub>IN</sub> reached the release voltage.

Release voltage (V<sub>DR</sub>) = Detect voltage (V<sub>DFL</sub>) + Hysteresis width (V<sub>HYS</sub>)

<sup>(7)</sup> The time to change the status of RESETB pin from the detect-status after the watchdog-timeout happens with the condition of WD=V<sub>SS</sub>.

<sup>(8)</sup> The time to change the status of RESETB pin from the release-status to the detect-status with the condition of WD=V<sub>SS</sub>.

<sup>(9)</sup> When V<sub>IN</sub> is changed during watchdog timeout time, until time when RESETB pin shows detect status after V<sub>IN</sub> reached the detect voltage.

<sup>(10)</sup> The ambient temperature range (-40°C ≤ Ta ≤ 125°C) is design Value.

## ELECTRICAL CHARACTERISTICS (Continued)

XC6131B Series

PARAMETER	SYMBOL	CONDITIONS	Ta=25°C			-40°C ≤ Ta ≤ 125°C <sup>(10)</sup>			UNITS	CIRCUIT	
			MIN.	TYP.	MAX.	MIN.	TYP.	MAX.			
Operating Voltage	V <sub>IN</sub>		1.5	-	6.0	1.5	-	6.0	V	①	
Detect Voltage	V <sub>DFL</sub>	V <sub>DF(T)</sub> <sup>(1)</sup> =1.6~5.0V	V <sub>DF(T)</sub> ×0.99	V <sub>DF(T)</sub>	V <sub>DF(T)</sub> ×1.01	V <sub>DF(T)</sub> ×0.975	V <sub>DF(T)</sub>	V <sub>DF(T)</sub> ×1.025	V		
Temperature Characteristics	$\frac{\Delta V_{DFL}}{(\Delta T_{opr} \cdot V_{DFL})}$	-40°C ≤ T <sub>opr</sub> ≤ 125°C	-	±50	-	-	±50	-	ppm /°C		
Hysteresis Width	V <sub>HYS</sub>		V <sub>DFL</sub> ×0.04	V <sub>DFL</sub> ×0.05	V <sub>DFL</sub> ×0.06	V <sub>DFL</sub> ×0.03	V <sub>DFL</sub> ×0.05	V <sub>DFL</sub> ×0.07	V		
Supply Current	I <sub>SS</sub>	V <sub>IN</sub> =V <sub>DF(T)</sub> × 0.9V	-	8.1	12.1	-	8.1	14.0	μA	②	
		V <sub>IN</sub> =V <sub>DF(T)</sub> × 1.1V	ENB=H <sup>(2)</sup>	-	2.5	3.5	-	2.5			5.0
			ENB=L	-	9.8	12.6	-	9.8			13.6
Output Current	I <sub>RBOUT</sub>	N-ch. V <sub>RESETB</sub> =0.3V	V <sub>IN</sub> =1.5V	2.6	3.5	-	1.4	3.5	mA	③	
			V <sub>IN</sub> =2.0V <sup>(3)</sup>	4.9	6.0	-	3.0	6.0			
			V <sub>IN</sub> =3.0V <sup>(3)</sup>	9.2	10.3	-	5.8	10.3			
			V <sub>IN</sub> =4.0V <sup>(4)</sup>	12.3	13.8	-	7.7	13.8			
Leakage Current	I <sub>Leak</sub>	V <sub>IN</sub> =6.0V, V <sub>RESETB</sub> =6.0V	-	0.01	0.1	-	0.01	μA	④		
Cd Pin Sink Current	I <sub>cd</sub>	V <sub>IN</sub> =1.5V, V <sub>Cd</sub> =0.7V	530	770	-	295	770	-			
Release Delay Time1 <sup>(6)</sup>	t <sub>DR1</sub>	V <sub>IN</sub> =1.5V → V <sub>DF(T)</sub> × 1.1V, Cd=0.01μF	8.5	10.0	11.5	7	10.0	12	ms	⑤	
Release Delay Time2 <sup>(7)</sup>	t <sub>DR2</sub>	V <sub>IN</sub> =V <sub>DF(T)</sub> × 1.1V, Cd=0.01μF	0.85	1.0	1.15	0.7	1.0	1.2			
Watchdog Timeout Period <sup>(8)</sup>	t <sub>WD</sub>	V <sub>IN</sub> =V <sub>DF(T)</sub> × 1.1V, Cd=0.01μF, WD=V <sub>SS</sub>	8.5	10.0	11.5	7	10.0	12			
Detect Delay Time <sup>(9)</sup>	t <sub>DF</sub>	V <sub>IN</sub> =V <sub>DF(T)</sub> × 1.1V → 1.5V, Cd=0.01μF	-	10.0	50	-	10.0	100			μs
Watchdog Minimum Pulse Width	t <sub>WDIN</sub>	V <sub>IN</sub> =6.0V, Apply pulse from 6.0V to 0V to the WD pin.	100	-	-	100	-	-	ns	⑥	
Watchdog High Level Voltage	V <sub>WDH</sub>	V <sub>DF(T)</sub> × 1.1V ≤ V <sub>IN</sub> ≤ 6.0V	V <sub>IN</sub> × 0.7	-	6	V <sub>IN</sub> × 0.7	-	6	V		
Watchdog Low Level Voltage	V <sub>WDL</sub>	V <sub>DF(T)</sub> × 1.1V ≤ V <sub>IN</sub> ≤ 6.0V	0	-	V <sub>IN</sub> × 0.3	0	-	V <sub>IN</sub> × 0.3	V		
Watchdog Pull-down Resistance	R <sub>WD</sub>	V <sub>WD</sub> =6.0V, R <sub>WD</sub> =V <sub>WD</sub> /I <sub>WD</sub>	280	550	1100	220	550	1350	kΩ	⑦	
ENB High Level Voltage	V <sub>ENBH</sub>	V <sub>IN</sub> =V <sub>DF(T)</sub> × 1.1V ~ 6.0V	1.3	-	V <sub>IN</sub>	1.3	-	V <sub>IN</sub>	V	⑧	
ENB Low Level Voltage	V <sub>ENBL</sub>		0	-	0.45	0	-	0.45	V	⑨	
ENB Pull-down Resistance	R <sub>ENB</sub>	V <sub>ENB</sub> =6.0V, R <sub>ENB</sub> =V <sub>ENB</sub> /I <sub>ENB</sub>	300	800	1200	230	800	1420	kΩ		

NOTE:

\*The WD pin and ENB pin are open unless otherwise specified in the measurement conditions.

<sup>(1)</sup> V<sub>DF(T)</sub>: Nominal detect voltage

<sup>(2)</sup> Excludes the current that flows to the EN pull-down resistance when ENB = H.

<sup>(3)</sup> For V<sub>DF(T)</sub> > 2.0V products only.

<sup>(4)</sup> For V<sub>DF(T)</sub> > 3.0V products only.

<sup>(5)</sup> For V<sub>DF(T)</sub> > 4.0V products only.

<sup>(6)</sup> Until time when RESETB pin shows release status after V<sub>IN</sub> reached the release voltage.

Release voltage (V<sub>DR</sub>) = Detect voltage (V<sub>DFL</sub>) + Hysteresis width (V<sub>HYS</sub>)

<sup>(7)</sup> The time to change the status of RESETB pin from the detect-status after the watchdog-timeout happens with the condition of WD=V<sub>SS</sub>.

<sup>(8)</sup> The time to change the status of RESETB pin from the release-status to the detect-status with the condition of WD=V<sub>SS</sub>.

<sup>(9)</sup> When V<sub>IN</sub> is changed during watchdog timeout time, until time when RESETB pin shows detect status after V<sub>IN</sub> reached the detect voltage.

<sup>(10)</sup> The ambient temperature range (-40°C ≤ Ta ≤ 125°C) is design Value.

## TEST CIRCUITS

CIRCUIT①



CIRCUIT②



CIRCUIT③



CIRCUIT④



CIRCUIT⑤



## TEST CIRCUITS (Continued)

CIRCUIT⑥



CIRCUIT⑦

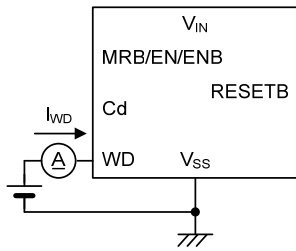

CIRCUIT⑧

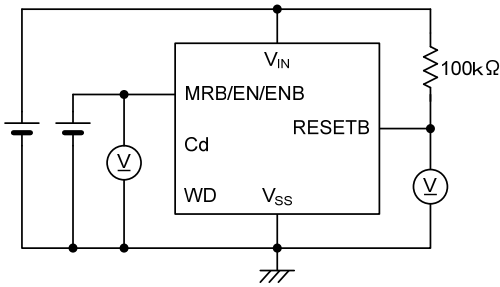

CIRCUIT⑨

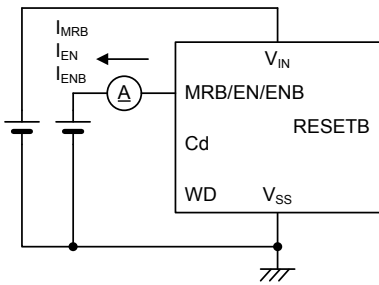

CIRCUIT⑩

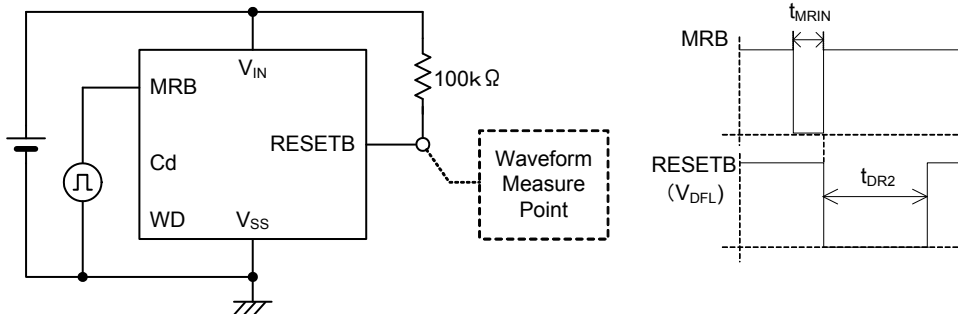

## OPERATIONAL EXPLANATION

In the XC6130/XC6131 Series, the voltage divided by RH, RX, and RY connected to the  $V_{IN}$  pin is compared to the internal reference voltage by the comparator, and the resulting output signal drives the watchdog logic and output driver. The  $V_{IN}$  pin voltage is gradually lowered, and when the  $V_{IN}$  pin voltage reaches the detect voltage, H→L level signal is output to the reset output pin ( $V_{DFL}$  type).



XC6130 Series

### <Output signal of reset output pin>

If the  $V_{IN}$  pin voltage is below the detect voltage, the reset output pin outputs H→L level signal.

After the  $V_{IN}$  pin voltage reaches the release voltage, the reset output pin holds L level during release delay time 1 ( $t_{DR1}$ ). If a start signal is not input to the WD pin within the watchdog timeout time, the reset output pin holds L level during release delay time 2 ( $t_{DR2}$ ) and then outputs H level signal.

### <Hysteresis>

If the internal comparator outputs L level signal, the PMOS transistor connected in parallel to RH turns ON and the hysteresis circuit activates. The hysteresis voltage width is obtained from the difference between the detect voltage and the release voltage.

The hysteresis width is ( $V_{DFL} \times 0.05$ ) V (TYP.).

### <WD pin>

A watchdog timer is used to detect abnormal operation and runaway in a microprocessor. If "L→H" signal is not input from the microprocessor within the watchdog timeout time, the reset output pin holds the detect state during release delay time 2 ( $t_{DR2}$ ), and then L→H level signal is output to the reset output pin.

In addition, the watchdog pin is pulled down internally to  $V_{SS}$ , and when the watchdog pin is OPEN, a reset signal is output after the watchdog timeout time.

The watchdog timeout time ( $t_{WD}$ ) can be set using the equation below.

$$t_{WD} = Cd \times 10^6$$

Example: When Cd is 0.1  $\mu$ F,  $t_{WD} = 0.1 \times 10^{-6} \times 10^6 = 100$ ms (TYP.)

## OPERATIONAL EXPLANATION (Continued)

### <Release delay time 1>

When power is added on the  $V_{IN}$ , the time from the point that  $V_{IN}$  reaches the release voltage until the reset output pin reaches the release voltage is release delay time 1 ( $t_{DR1}$ ).

Release delay time 1 ( $t_{DR1}$ ) can be set using the equation below.

$$t_{DR1} = Cd \times 10^6$$

Example: When Cd is 0.1 $\mu$ F,  $t_{DR1} = 0.1 \times 10^{-6} \times 10^6 = 100\text{ms}$  (TYP.)

### <Release delay time 2>

Release delay time 2 ( $t_{DR2}$ ) is the duration of the detect state until the watchdog timer restarts when "L  $\rightarrow$  H" signal is not input to the WD pin within the watchdog timeout time.

Release delay time 2 ( $t_{DR2}$ ) can be set using the equation below.

$$t_{DR2} = Cd \times 10^5$$

Example: When Cd is 0.1 $\mu$ F,  $t_{DR2} = 0.1 \times 10^{-6} \times 10^5 = 10\text{ms}$  (TYP.)

### <Detect delay time>

The detect delay time ( $t_{DF}$ ) is the time until the  $V_{IN}$  pin voltage drops to the detect voltage and the reset output pin enters the detect state.

### <MRB pin> \*XC6130 Series

The MRB pin voltage can be input to force the signal of the reset output pin to the detect state.

When the MRB pin voltage input reaches an H $\rightarrow$ L level signal, an H $\rightarrow$ L level signal is output to the reset output pin. After the MRB pin voltage reaches L $\rightarrow$ H level, the reset output pin holds the detect state during release delay time 1 ( $t_{DR1}$ ).

### <EN pin> \*XC6131A Series

If the watchdog function will not be used, the EN pin can be set to L level to forcibly stop only the watchdog function and keep the voltage detector operating. When using the watchdog function, use the EN pin at H level. If the input voltage and EN pin voltage reach L $\rightarrow$ H level, the reset output pin holds the detect state during release delay time 1 ( $t_{DR1}$ ). (Refer to Timing Chart 2, ①)

If the input voltage is higher than the release voltage and the EN pin voltage reaches L $\rightarrow$ H level, the watchdog function recovers. (Refer to Timing Chart 2, ②)

### <ENB Pin> \*XC6131B Series

When the watchdog function is not used, the ENB pin can be set to H level to keep the voltage detector operating and forcibly stop only the watchdog function. To use the watchdog function, use the ENB pin at L level. When the input voltage and ENB pin voltage reach H $\rightarrow$ L level, the reset output pin holds the detect state during release delay time 1 ( $t_{DR1}$ ). (Refer to Timing Chart 3, ①)

When the input voltage is higher than the release voltage and the ENB pin voltage reaches H $\rightarrow$ L level, the watchdog function recovers. (Refer to Timing Chart 3, ②)

## OPERATIONAL EXPLANATION (Continued)

<Timing Chart 1>

XC6130 Series



## OPERATIONAL EXPLANATION (Continued)

<Timing Chart 2>

XC6131A Series





■ OPERATIONAL EXPLANATION(Continued)

<Timing Chart 3>

XC6131B Series



## NOTES ON USE

1. Use this IC within the absolute maximum ratings. Risk of deterioration or damage if the absolute maximum ratings are exceeded during temporary or transient voltage drops or voltage jumps.
2. If a resistance is added between the power and the VIN pin, the flowthrough current when the IC operates will cause the VIN pin voltage to drop and the IC may malfunction.
3. When raising the input voltage from the minimum operating voltage or less, if changed suddenly, the release delay time may become short.
4. Sufficiently reinforce the VIN and GND lines, as power noise may cause malfunctioning of the watchdog function and voltage detector. It is recommended that a capacitor be added between VIN and GND.
5. Enter "H" level, or "L" level should be fed to MRB and EN/ENB pin.
6. To ensure stable operation of the watchdog function, be sure to add a capacitor at the Cd pin.  
The release delay time and watchdog timeout time are affected by the accuracy and temperature characteristics of the Cd pin capacitor.
7. If the Cd pin capacitor is unable to discharge to the ground level during recovery after a power interruption, the release delay may become noticeably shorter. Exercise caution.
8. The output voltage at detection is determined by the pull-up resistance connected to RESETB pin.  
Select the resistance based on the following considerations:

$$\text{At detection: } V_{\text{RESETB}} = (V_{\text{pull-Up}}) / (1 + R_{\text{pull}} / R_{\text{ON}})$$

Vpull-Up: Voltage after pull-up

R<sub>ON</sub><sup>(1)</sup>: ON resistance of N-ch driver (calculated from  $V_{\text{RESETB}} / I_{\text{RBOUT1}}$  in electrical characteristics)<sup>(3)</sup>

Example calculation:

When  $V_{\text{IN}} = 2.0\text{V}$ <sup>(2)</sup>,  $R_{\text{ON}} = 0.3 / 4.9 \times 10^{-3} \approx 61.2\Omega$  (MAX. ). If you wish to make the VRESETB voltage at detection 0.1V or lower with Vpull-Up=3.0V,

$$R_{\text{pull}} = (V_{\text{pull-Up}} / V_{\text{RESETB}} - 1) \times R_{\text{ON}} = (3 / 0.1 - 1) \times 61.2 \approx 1.8\text{k}\Omega,$$

and thus to make the output voltage at detection 0.1V or less under the above conditions, the pull-up resistance must be 1.8kΩ or higher.

<sup>(1)</sup> The smaller  $V_{\text{IN}}$  is, the larger  $R_{\text{ON}}$  becomes.

<sup>(2)</sup> When selecting  $V_{\text{IN}}$ , calculate using the lowest value of the input voltage range you will use.

<sup>(3)</sup>  $I_{\text{RBOUT1}}$  specified in the electrical characteristics is the value at  $T_a = 25^\circ\text{C}$ .  $I_{\text{RBOUT1}}$  varies depending on the ambient temperature.

To select the pull-up resistance taking ambient temperature into account, please calculate  $I_{\text{RBOUT}}$  with the MIN. value of the ambient temperature range of  $-40^\circ\text{C} \leq T_a \leq 125^\circ\text{C}$ .

$$\text{At release: } V_{\text{RESETB}} = (V_{\text{pull-Up}}) / (1 + R_{\text{pull}} / R_{\text{OFF}})$$

Vpull-Up: Voltage after pull-up

R<sub>OFF</sub>: Resistance value 60MΩ (MIN. )

when N-ch driver is OFF (calculated from  $V_{\text{RESETB}} / I_{\text{LEAK}}$  in electrical characteristics)

Calculation example:

If you wish to make  $V_{\text{RESETB}}$  5.99V or higher with Vpull-Up=6.0V

$$R_{\text{pull}} = (V_{\text{pull-Up}} / V_{\text{RESETB}} - 1) \times R_{\text{OFF}} = (6 / 5.99 - 1) \times 60 \times 10^9 \approx 100\text{k}\Omega,$$

and thus to make the output voltage 5.99V or higher at release under the above conditions, the pull-up resistance must be 100kΩ or less.

9. We place importance on improving our products and increasing reliability. However, please design safety into the device and system, including fail-safe design and post-aging treatment.

# TYPICAL PERFORMANCE CHARACTERISTICS

## (1) Detect, Release Voltage vs. Ambient Temperature

XC6130, XC6131 ( $V_{DF(T)}=1.6V$ )



XC6130, XC6131 ( $V_{DF(T)}=3.0V$ )



## (2) Detect, Release Voltage vs. Input Voltage

XC6130, XC6131 ( $V_{DF(T)}=5.0V$ )



XC6130, XC6131 ( $V_{DF(T)}=1.6V$ )



XC6130, XC6131 ( $V_{DF(T)}=3.0V$ )



XC6130, XC6131 ( $V_{DF(T)}=5.0V$ )



## TYPICAL PERFORMANCE CHARACTERISTICS (Continued)

### (3) Supply Current vs. Input Voltage



## TYPICAL PERFORMANCE CHARACTERISTICS (Continued)

### (3) Supply Current vs. Input Voltage (Continued)



### (4) Output Current vs. $V_{RESETB}$



### (5) Output Current vs. Input Voltage



## TYPICAL PERFORMANCE CHARACTERISTICS (Continued)

(6) Cd Sink Current vs. Ambient Temperature



(7) Release Delay Time1 vs. Ambient Temperature

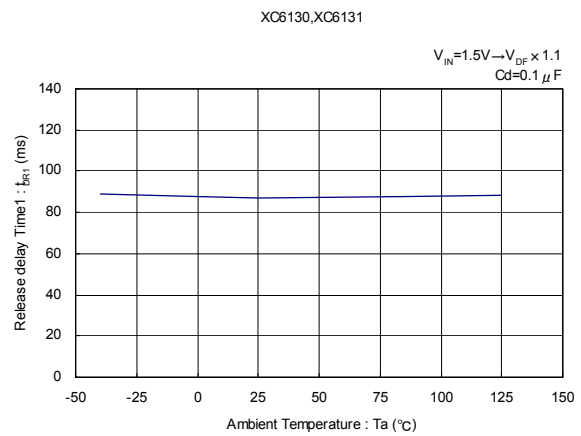

(8) Release Delay Time2 vs. Ambient Temperature

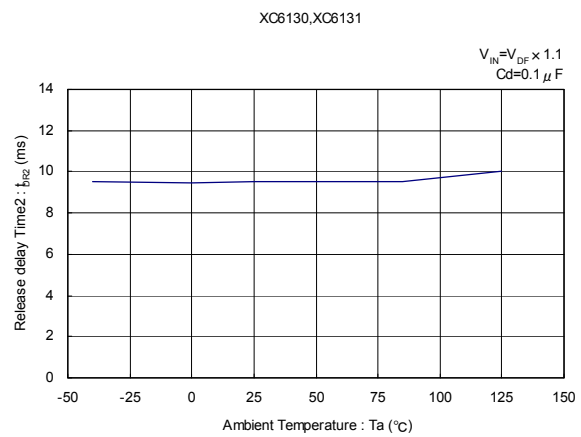

## TYPICAL PERFORMANCE CHARACTERISTICS (Continued)

(9) Watchdog Timeout Period vs. Ambient Temperature



(10) WD High Level Threshold Voltage vs. Ambient Temperature



(11) WD Low Level Threshold Voltage vs. Ambient Temperature



## TYPICAL PERFORMANCE CHARACTERISTICS (Continued)

(12) MRB High Level Threshold Voltage vs. Ambient Temperature



(13) MRB Low Level Threshold Voltage vs. Ambient Temperature



(14) EN High Level Threshold Voltage vs. Ambient Temperature



(15) EN Low Level Threshold Voltage vs. Ambient Temperature



(16) ENB High Level Threshold Voltage vs. Ambient Temperature



(17) ENB Low Level Threshold Voltage vs. Ambient Temperature





## ■ TYPICAL PERFORMANCE CHARACTERISTICS (Continued)

(18) MRB Pull-up Resistance vs. Ambient Temperature



(19) EN Pull-up Resistance vs. Ambient Temperature

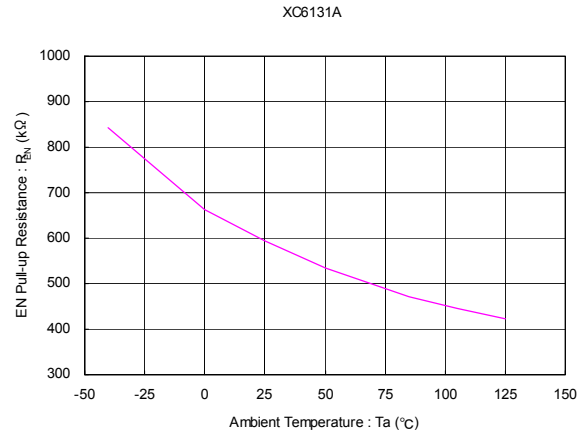

(20) ENB Pull-down Resistance vs. Ambient Temperature



(21) WD Pull-up Resistance vs. Ambient Temperature





## ■ PACKAGING INFORMATION (Continued)

### ● SOT-26 Power Dissipation (Topmax+125°C)

Power dissipation data for the SOT-26 is shown in this page.  
The value of power dissipation varies with the mount board conditions.  
Please use this data as the reference data taken in the following condition.

#### 1. Measurement Condition

- Condition: Mount on a board
- Ambient: Natural convection
- Soldering: Lead (Pb) free
- Board: Dimensions 40 x 40 mm (1600 mm<sup>2</sup> in one side)  
Copper (Cu) traces occupy 50% of the board area  
In top and back faces  
(Board of SOT-26 is used)
- Material: Glass Epoxy (FR-4)
- Thickness: 1.6mm
- Through-hole 4 x 0.8 Diameter



Evaluation Board (Unit: mm)

#### 2. Power Dissipation vs. Ambient Temperature

Board Mount (T<sub>jmax</sub>=125°C)

Ambient Temperature (°C)	Power Dissipation Pd (mW)	Thermal Resistance (°C/W)
25	600	166.67
85	240	

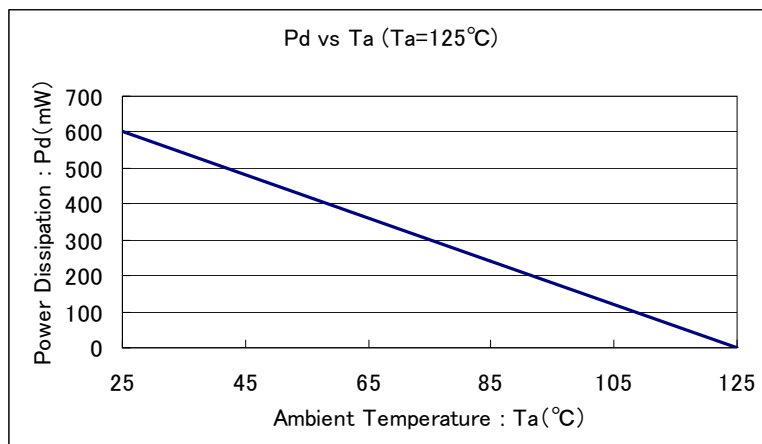

## MARKING RULE

### ●XC6130

SOT-26



① represents products series

MARK	PRODUCT SERIES
4	XC6130*****-G

② represents type of detector and detect voltage

MARK	DETECT VOLTAGE (V)	PRODUCT TYPE	PRODUCT SERIES
1	1.6~2.0	A	XC6130A*****-G
2	2.1~3.0		
3	3.1~4.0		
4	4.1~5.0		

③ represents detect voltage

MARK	DETECT VOLTAGE (V)	MARK	DETECT VOLTAGE (V)
1	x.1	6	x.6
2	x.2	7	x.7
3	x.3	8	x.8
4	x.4	9	x.9
5	x.5	0	x.0

④⑤ represents production lot number

01~09, 0A~0Z, 11~9Z, A1~A9, AA~AZ, B1~ZZ in order.

(G, I, J, O, Q, W excluded)

\* No character inversion used.

## MARKING RULE (Continued)

●XC6131

SOT-26

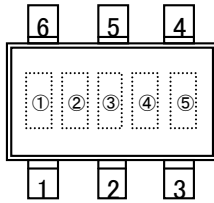

① represents products series

MARK	PRODUCT SERIES
4	XC6131*****-G

② represents type of detector and detect voltage

MARK	DETECT VOLTAGE (V)	PRODUCT TYPE	PRODUCT SERIES
A	1.6~2.0	A	XC6131A*****-G
B	2.1~3.0		
C	3.1~4.0		
D	4.1~5.0		
E	1.6~2.0	B	XC6131B*****-G
F	2.1~3.0		
H	3.1~4.0		
K	4.1~5.0		

③ represents detect voltage

MARK	DETECT VOLTAGE (V)	MARK	DETECT VOLTAGE (V)
1	x.1	6	x.6
2	x.2	7	x.7
3	x.3	8	x.8
4	x.4	9	x.9
5	x.5	0	x.0

④⑤ represents production lot number

01~09, 0A~0Z, 11~9Z, A1~A9, AA~AZ, B1~ZZ in order.

(G, I, J, O, Q, W excluded)

\* No character inversion used.

1. The products and product specifications contained herein are subject to change without notice to improve performance characteristics. Consult us, or our representatives before use, to confirm that the information in this datasheet is up to date.
2. We assume no responsibility for any infringement of patents, patent rights, or other rights arising from the use of any information and circuitry in this datasheet.
3. Please ensure suitable shipping controls (including fail-safe designs and aging protection) are in force for equipment employing products listed in this datasheet.
4. The products in this datasheet are not developed, designed, or approved for use with such equipment whose failure or malfunction can be reasonably expected to directly endanger the life of, or cause significant injury to, the user.  
(e.g. Atomic energy; aerospace; transport; combustion and associated safety equipment thereof.)
5. Please use the products listed in this datasheet within the specified ranges.  
Should you wish to use the products under conditions exceeding the specifications, please consult us or our representatives.
6. We assume no responsibility for damage or loss due to abnormal use.
7. All rights reserved. No part of this datasheet may be copied or reproduced without the prior permission of TOREX SEMICONDUCTOR LTD.

**TOREX SEMICONDUCTOR LTD.**



Компания «ЭлектроПласт» предлагает заключение долгосрочных отношений при поставках импортных электронных компонентов на взаимовыгодных условиях!

Наши преимущества:

- Оперативные поставки широкого спектра электронных компонентов отечественного и импортного производства напрямую от производителей и с крупнейших мировых складов;
- Поставка более 17-ти миллионов наименований электронных компонентов;
- Поставка сложных, дефицитных, либо снятых с производства позиций;
- Оперативные сроки поставки под заказ (от 5 рабочих дней);
- Экспресс доставка в любую точку России;
- Техническая поддержка проекта, помощь в подборе аналогов, поставка прототипов;
- Система менеджмента качества сертифицирована по Международному стандарту ISO 9001;
- Лицензия ФСБ на осуществление работ с использованием сведений, составляющих государственную тайну;
- Поставка специализированных компонентов (Xilinx, Altera, Analog Devices, Intersil, Interpoint, Microsemi, Aeroflex, Peregrine, Syfer, Eurofarad, Texas Instrument, Miteq, Cobham, E2V, MA-COM, Hittite, Mini-Circuits, General Dynamics и др.);

Помимо этого, одним из направлений компании «ЭлектроПласт» является направление «Источники питания». Мы предлагаем Вам помощь Конструкторского отдела:

- Подбор оптимального решения, техническое обоснование при выборе компонента;
- Подбор аналогов;
- Консультации по применению компонента;
- Поставка образцов и прототипов;
- Техническая поддержка проекта;
- Защита от снятия компонента с производства.



#### Как с нами связаться

**Телефон:** 8 (812) 309 58 32 (многоканальный)

**Факс:** 8 (812) 320-02-42

**Электронная почта:** [org@eplast1.ru](mailto:org@eplast1.ru)

**Адрес:** 198099, г. Санкт-Петербург, ул. Калинина, дом 2, корпус 4, литера А.