

General Purpose

Power Relay

SZR-LY Series

FEATURES

- Small package design
- ARC barrier equipped
- Silver Cadmium Oxide contact
- High dielectric strength (1,800 Vac)
- High reliability and long life
- Ultra-high sensitivity with quick response time (25 ms max.)
- High vibration and shock resistance
- Options include LED indicator, diode protection, and LED indicator/diode protection
- UL listed, CE certified, CSA certified

TYPICAL APPLICATIONS

- Control panels
- Elevator panels
- Machine tools
- Test equipment



SZR-LY Series general-purpose power relays are designed for a wide range of applications including power as well as logic control for factory machines and control panels.

SZR-LY Series relays break 10 A loads and are ideal for control panels that require stable and reliable relays.

One standard and three options are available: LED indicator, internal surge protection diode, and LED indicator/diode protection. Honeywell's global sales and distribution channels ensure a rapid response and excellent customer service.

⚠ WARNING

PERSONAL INJURY

DO NOT USE these products as safety or emergency stop devices or in any other application where failure of the product could result in personal injury.

Failure to comply with these instructions could result in death or serious injury.

⚠ WARNING

MISUSE OF DOCUMENTATION

- The information presented in this product sheet is for reference only. Do not use this document as a product installation guide.
- Complete installation, operation, and maintenance information is provided in the instructions supplied with each product.

Failure to comply with these instructions could result in death or serious injury.

General Purpose





Power Relays

SZR-LY Series

RELAY MODEL SELECTION GUIDE

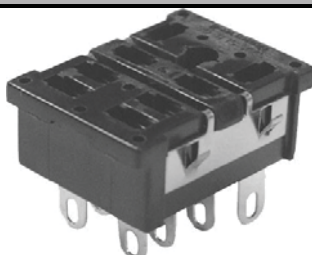
Type	Terminal	Contact	Catalog Listing
Standard	Plug-in/Solder	DPDT	SZR-LY2-1
		4PDT	SZR-LY4-1
	PCB	DPDT	SZR-LY2-1P
		4PDT	SZR-LY4-1P
LED Indicator	Plug-in/Solder	DPDT	SZR-LY2-N1
		4PDT	SZR-LY4-N1
DIODE surge suppression		DPDT	SZR-LY2-D1
		4PDT	SZR-LY4-D1
LED indicator + surge suppression		DPDT	SZR-LY2-X1
		4PDT	SZR-LY4-X1

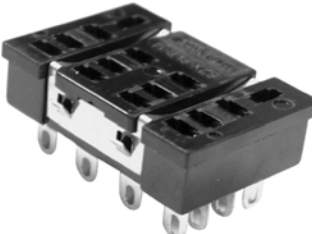
SOCKETS – REQUIRED ACCESSORIES

Relay Contact	Din-rail Mounting	Solder Terminal	PCB Terminal
DPDT For use with SZR-LY2-1, - N1, -D1, -X1	 SZX-SLF-08N	 SZX-SLB-08	 SZX-SLB-08P
4PDT For use with SZR-LY4-1, - N1, -D1, -X1	 SZX-SLF-14	 SZX-SLB-14	 SZX-SLB-14P

CONTACT RATINGS

Ratings	Load	Resistive Load (p.f. = 1)	Inductive load (p.f. = 0.4, L/R = 7 ms)
Rated load		110 Vac, 10 A 24 Vdc, 10 A	110 Vac, 7.5 A 24 Vdc, 5 A
Carry current		10 A	
Max. operating voltage		250 Vac, 125 Vdc	
Max. operating current		10 A	
Max. switching capacity		1,100 VA, 240 W	825 VA, 120 W
Min. permissible load		5 Vdc, 100 mA	

General Purpose

Power Relays

SZR-LY Series

COIL RATINGS (DPDT)

	Rated Voltage (V)	Rated Current (mA)		Coil resistance (Ω)	Coil Inductance (H)		Pick-up Voltage (V)	Dropout Voltage (V)	Maximum Voltage (V)	Power Consumption (W)
		50 Hz	60 Hz		Armature OFF	Armature ON				
AC	6	214.1	183	12.2	0.04	0.08	Max. 80 %	Min. 30%	110%	Approx. 1.0 W to 1.2 W (60 Hz)
	12	106.5	91	46	0.17	0.33				
	24	53.8	46	180	0.69	1.3				
	50	25.7	22	788	3.22	5.66				Approx. 0.9 W to 1.1 W (60 Hz)
	100/110	11.7/12.9	10/11	3,750	14.54	24.6				
	110/120	9.9/10.8	8.4/9.2	4,430	19.2	32.1				
	200/220	6.2/6.8	5.3/5.8	12,950	54.75	94.07				
220/240	4.8/5.3	4.2/4.6	18,790	83.5	136.4					
DC	6	150		40	0.17	0.33	Max. 80%	Min. 10%	110%	Approx. 0.9 W
	12	75		160	0.73	1.37				
	24	36.9		650	3.2	5.72				
	48	18.5		2,600	10.6	21.0				
	100/110	9.1/10		11,000	45.6	86.2				

COIL RATINGS (4PDT)

	Rated Voltage (V)	Rated Current (mA)		Coil resistance (Ω)	Coil Inductance (H)		Pick-up Voltage (V)	Dropout Voltage (V)	Maximum Voltage (V)	Power Consumption (W)
		50 Hz	60 Hz		Armature OFF	Armature ON				
AC	6	386	330	5	0.02	0.04	Max. 80 %	Min. 30%	110%	Approx. 1.95 W to 2.5 W (60 Hz)
	12	199	170	20	0.1	0.17				
	24	93.6	80	78	0.38	0.67				
	50	46.8	40	350	1.74	2.88				
	100/110	22.5/25.5	19/21.8	1,800	10.5	17.3				
	200/220	11.5/13.1	9.8/11.2	6,700	33.1	57.9				
DC	6	240		25	0.09	0.21	Max. 80%	Min. 10%	110%	Approx. 1.5 W
	12	120		100	0.39	0.84				
	24	69		350	1.41	2.91				
	48	30		1,600	6.39	13.6				
	100/110	15/15.9		6,900	32	63.7				

Note 1: The rated current and coil resistance are measured at a coil temperature of 23 °C [73.4 °F] with tolerances of +15%, -20% for AC rated current and ± 15% for DC coil resistance.

Note 2: The rated current of N1 and X1 types is 4 mA higher than the value in the table above.

General Purpose

Power Relays

SZR-LY Series

SPECIFICATIONS

Contact material		Silver Cadium Oxide
Contact resistance		Max. 50 MOhm
Operate time		Max. 25 ms
Release time		Max. 25 ms
Operating frequency	Mechanical	18,000 operations per hour
	Electrical	1,800 operations per hour
Insulation resistance		Min. 100 Mw at 500 Vdc
Dielectric withstand voltage		1,800 Vac 50 Hz/60 Hz for one minute between non-continuous current carrying terminals and between coil terminals and contact terminals 1,000 Vac 50/60 Hz for 1 minute between contacts of same polarity
Vibration resistance	Mechanical durability	10 Hz to 55 Hz at double amplitude of 1.0 mm
	Malfunction durability	10 Hz to 55 Hz at double amplitude of 1.0 mm
Shock resistance	Mechanical durability	1,000 m/s ² (approx. 100 g)
	Malfunction durability	200 m/s ² (approx. 20 g)
Service life	Mechanical	AC: Min. 50 million operations (at operating frequency of 18,000 operations/hour) DC: Min. 100 million operations (at operating frequency of 18,000 operations/hour)
	Electrical	DPDT: Min. 500,000 operations (at operating frequency of 1,800 operations/hour) 4PDT: Min. 200,000 operations (at operating frequency of 1,800 operations/hour)
Weight		DPDT: Approximately 35 g 4PDT: Approximately 65 g

Note 1: The data shown above are of initial value

CHARACTERISTIC DATA

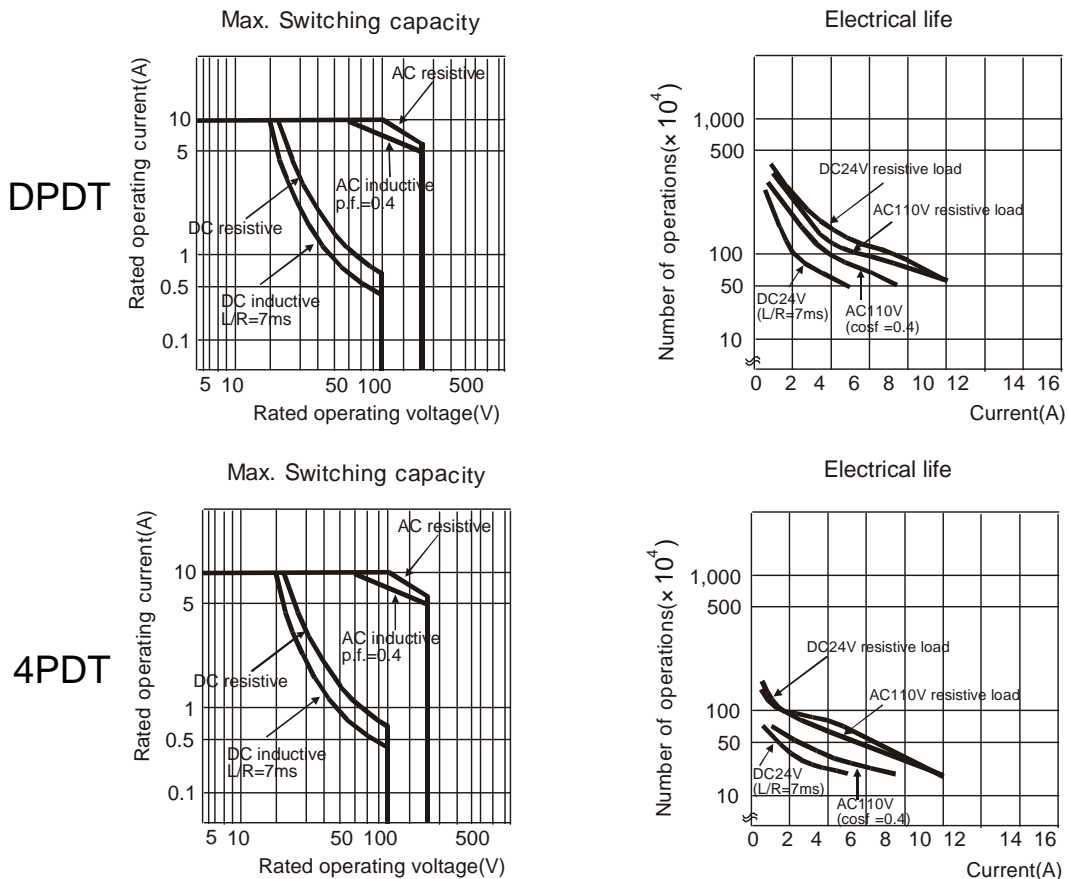

General Purpose

Power Relays

SZR-LY Series

CATALOG LISTING MATRIX

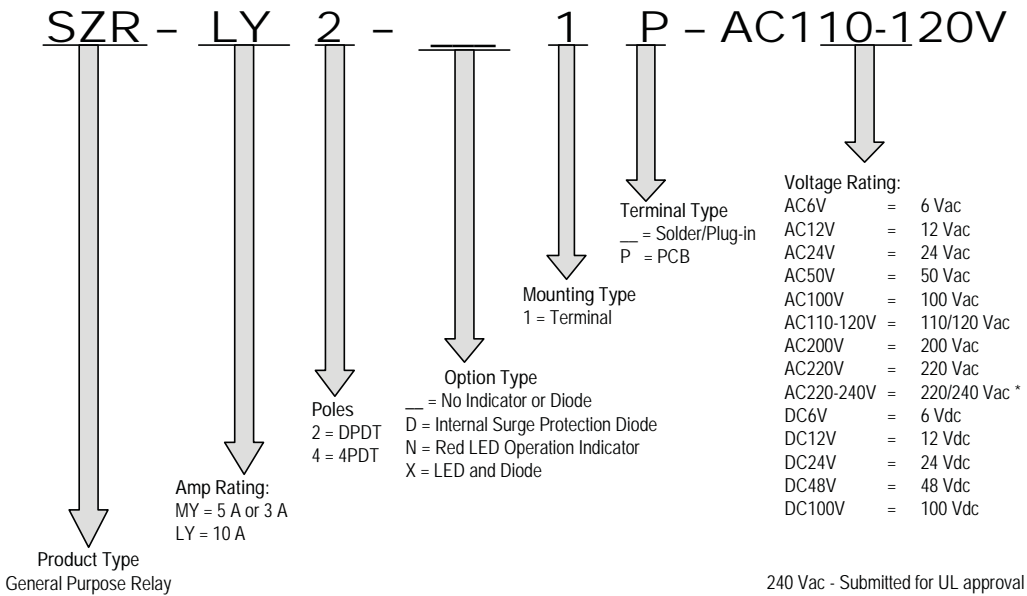

General Purpose

Power Relays

SZR-LY Series

HOLDING CLIPS

- Holding clips are included with the sockets
- Holding clips for the SLF-08N cannot be removed once inserted
- The holding clip for the SLF-14 can be removed by pushing the side of the inserting hold with a sharp object
- Holding clips for all SMB sockets are wire for easy removal
- Holding clips are to be inserted into the slots provided on the socket

DIMENSIONS (For reference only – mm/in)

Figure 1. Dimensions

For SZX-SLF-14 sockets

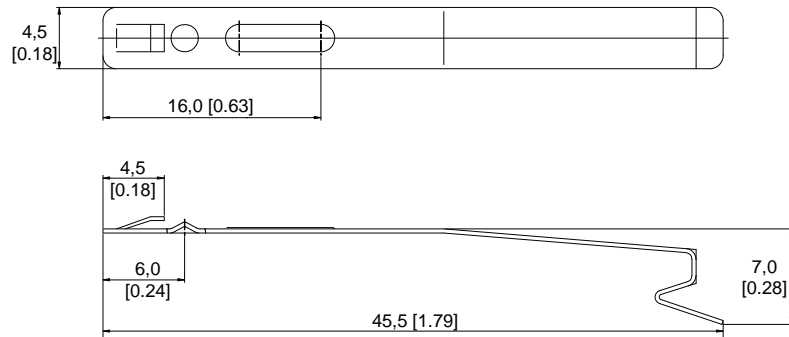

Figure 2. Dimensions

For SZX-SLF-08N sockets

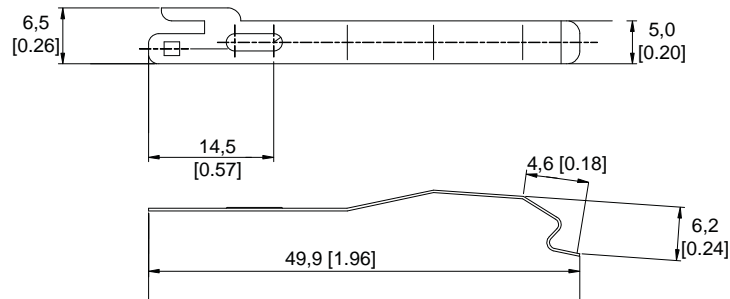
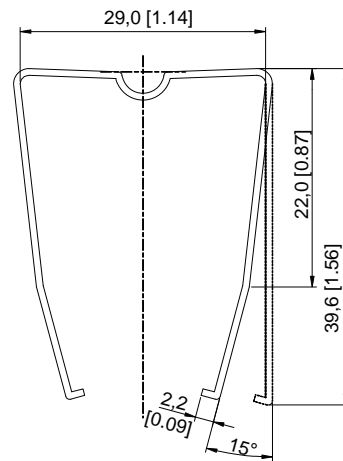

Figure 3. Dimensions

For all SZX-SLB sockets



General Purpose

Power Relays

SZR-LY Series

FIGURE 4. DIMENSION, CIRCUIT DIAGRAM, TERMINAL ARRANGEMENT, AND MOUNTING HOLE FOR SZR-LY2-1, SZR-LY2-N1, SZR-LY2-D1, and SZR-LY2-X1

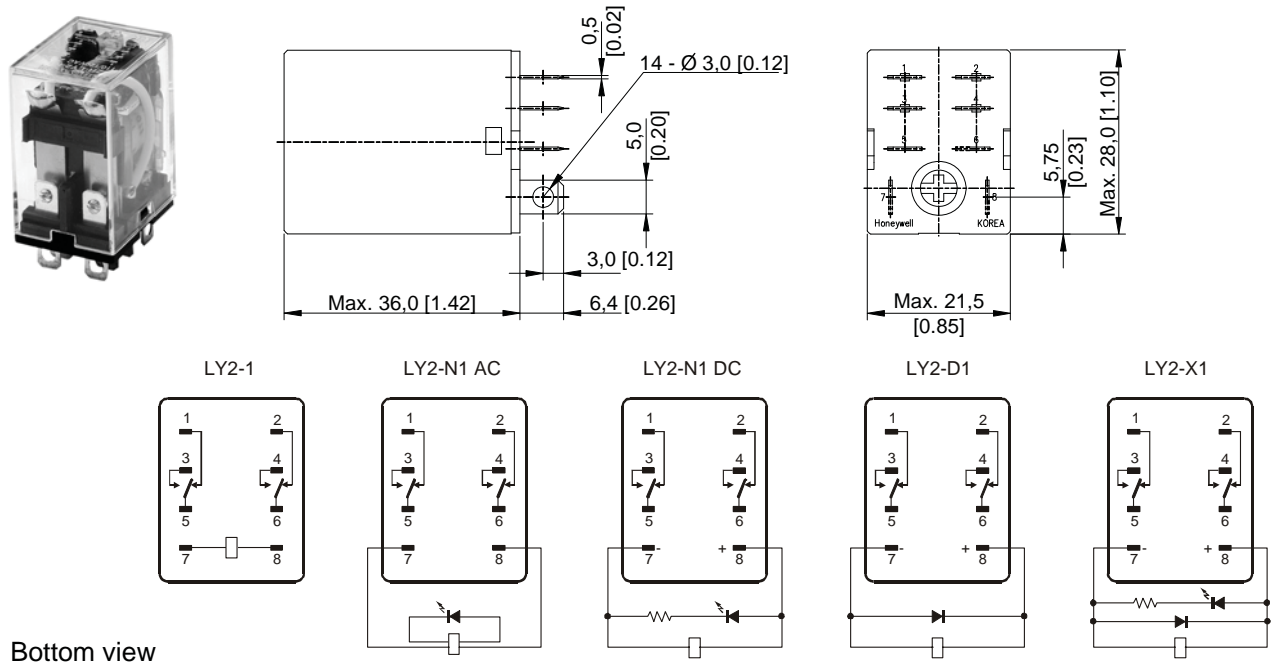
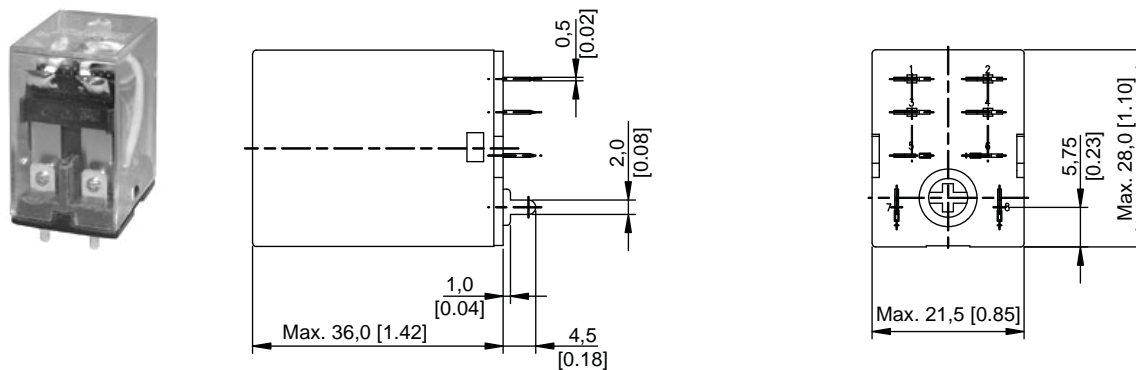

FIGURE 5. DIMENSION, CIRCUIT DIAGRAM, TERMINAL ARRANGEMENT, AND MOUNTING HOLE FOR SZR-MY2-1P and SZR-MY4-1P



The circuit diagram is the same with standard type of SZR-MY2-1 or the SZR-MY4-1

General Purpose

Power Relays

SZR-LY Series

FIGURE 6. DIMENSION, CIRCUIT DIAGRAM, TERMINAL ARRANGEMENT, AND MOUNTING HOLE FOR SZR-LY4-1, SZR-LY4-N1, SZR-LY4-D1, and SZR-LY4-X1

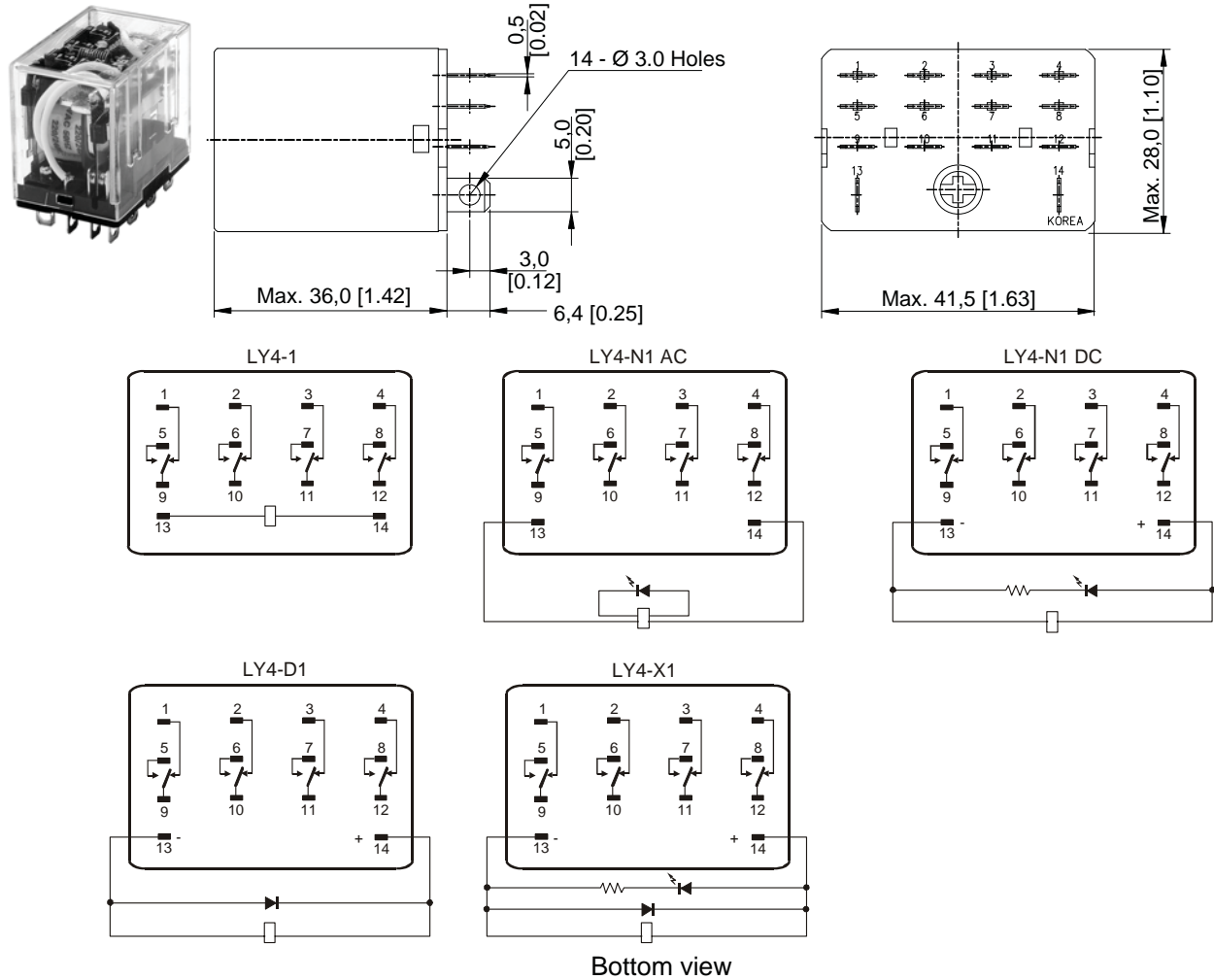
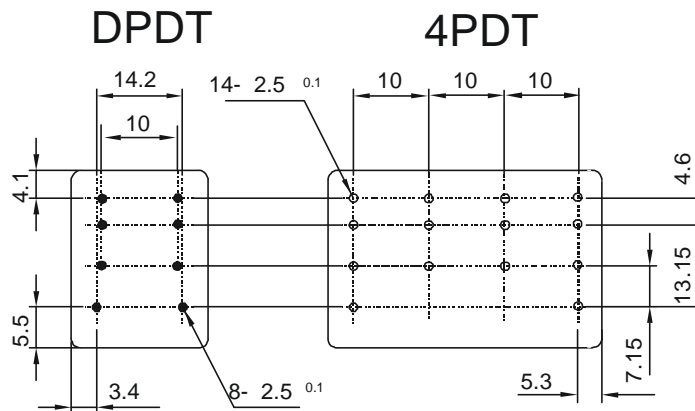

FIGURE 7. CIRCUIT DRAWING FOR SZR-LY2- and SZR-LY4-



General Purpose Power Relays

SZR-LY Series

SOCKETS

FIGURE 8. SZX-SLF-08N

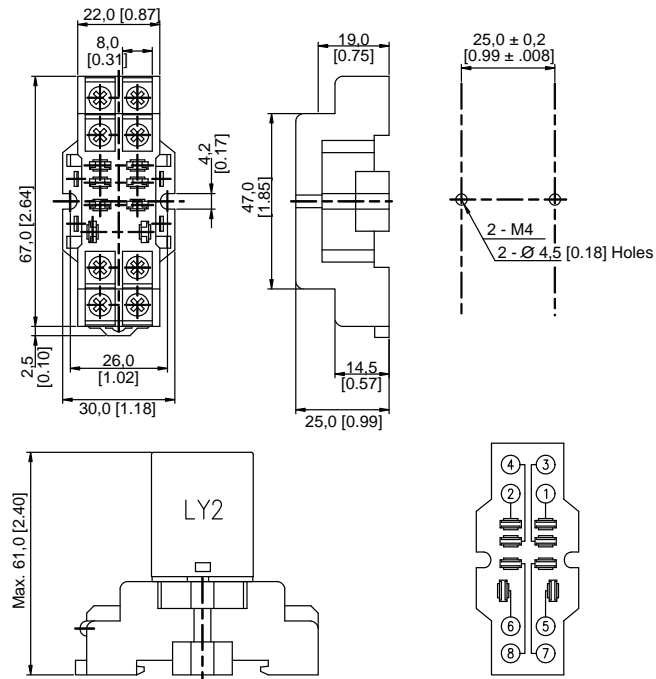

FIGURE 9. SZX-SLF-14

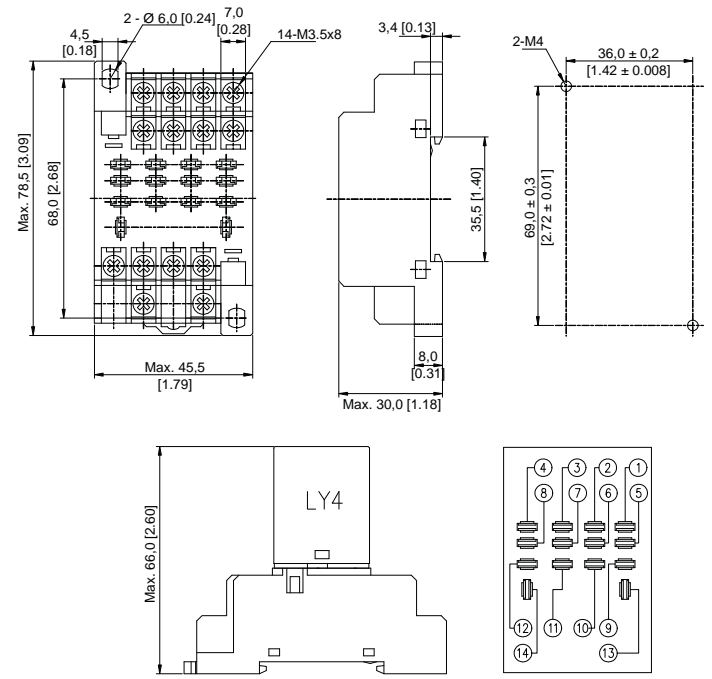

FIGURE 10. SZX-SLB-08

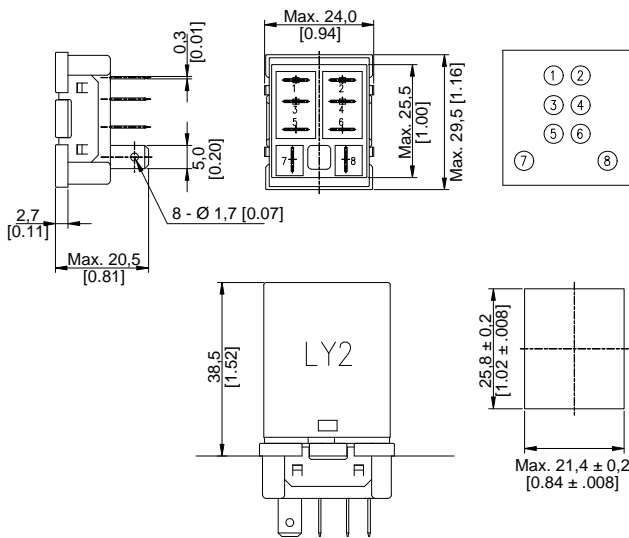
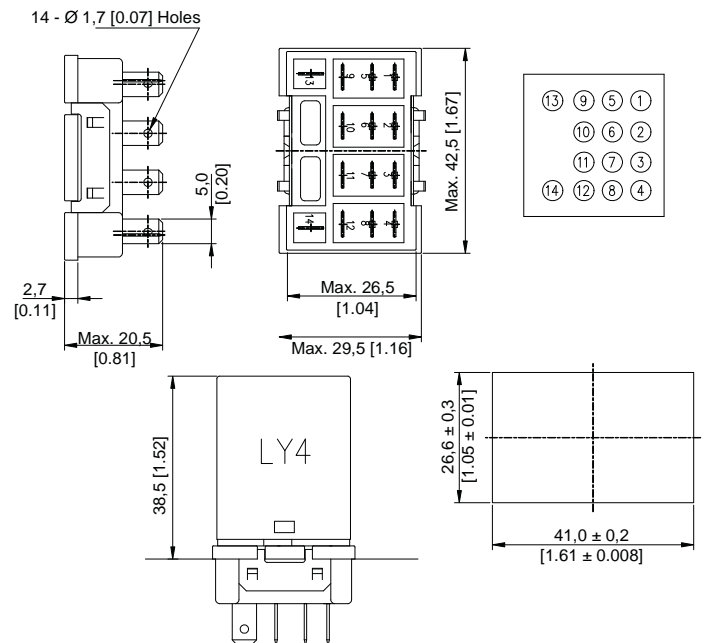

FIGURE 11. SZX-SLB-14



General Purpose

Power Relays

SZR-LY Series

FIGURE 12. SZX-SLB-08P

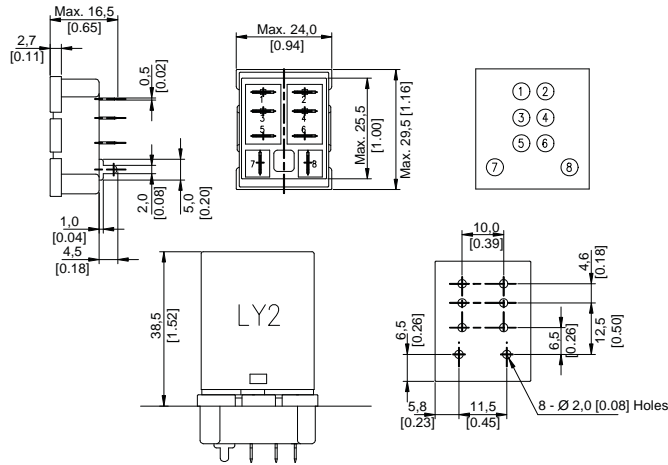
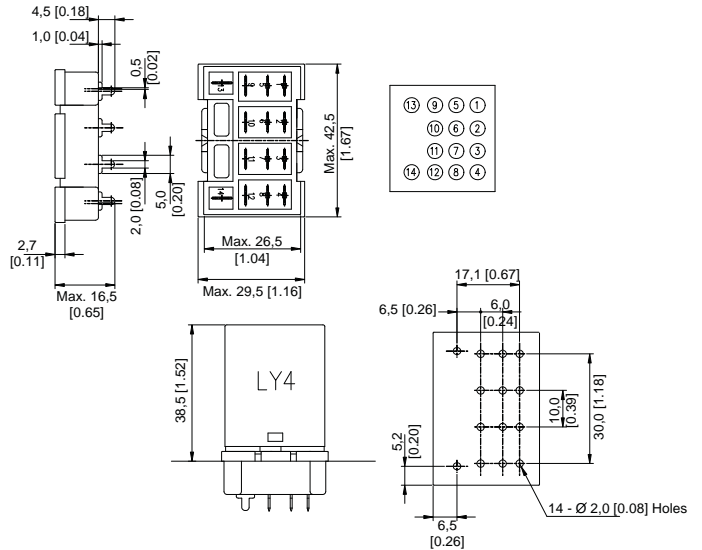

FIGURE 13. SZX-SLB-14P



WARRANTY/REMEDY

Honeywell warrants goods of its manufacture as being free of defective materials and faulty workmanship. Contact your local sales office for warranty information. If warranted goods are returned to Honeywell during the period of coverage, Honeywell will repair or replace without charge those items it finds defective. **The foregoing is Buyer's sole remedy and is in lieu of all other warranties, expressed or implied, including those of merchantability and fitness for a particular purpose.**

Specifications may change without notice. The information we supply is believed to be accurate and reliable as of this printing. However, we assume no responsibility for its use.

While we provide application assistance personally, through our literature and the Honeywell web site, it is up to the customer to determine the suitability of the product in the application.

For application assistance, current specifications, or name of the nearest Authorized Distributor, contact a nearby sales office. Or call:

1-800-537-6945 USA/Canada

1-815-235-6847 International

FAX

1-815-235-6545 USA

INTERNET

www.honeywell.com/sensing

info.sc@honeywell.com

Honeywell

Sensing and Control
www.honeywell.com/sensing

Honeywell
 11 West Spring Street
 Freeport, Illinois 61032



Компания «ЭлектроПласт» предлагает заключение долгосрочных отношений при поставках импортных электронных компонентов на взаимовыгодных условиях!

Наши преимущества:

- Оперативные поставки широкого спектра электронных компонентов отечественного и импортного производства напрямую от производителей и с крупнейших мировых складов;
- Поставка более 17-ти миллионов наименований электронных компонентов;
- Поставка сложных, дефицитных, либо снятых с производства позиций;
- Оперативные сроки поставки под заказ (от 5 рабочих дней);
- Экспресс доставка в любую точку России;
- Техническая поддержка проекта, помощь в подборе аналогов, поставка прототипов;
- Система менеджмента качества сертифицирована по Международному стандарту ISO 9001;
- Лицензия ФСБ на осуществление работ с использованием сведений, составляющих государственную тайну;
- Поставка специализированных компонентов (Xilinx, Altera, Analog Devices, Intersil, Interpoint, Microsemi, Aeroflex, Peregrine, Syfer, Eurofarad, Texas Instrument, Miteq, Cobham, E2V, MA-COM, Hittite, Mini-Circuits, General Dynamics и др.);

Помимо этого, одним из направлений компании «ЭлектроПласт» является направление «Источники питания». Мы предлагаем Вам помощь Конструкторского отдела:

- Подбор оптимального решения, техническое обоснование при выборе компонента;
- Подбор аналогов;
- Консультации по применению компонента;
- Поставка образцов и прототипов;
- Техническая поддержка проекта;
- Защита от снятия компонента с производства.



Как с нами связаться

Телефон: 8 (812) 309 58 32 (многоканальный)

Факс: 8 (812) 320-02-42

Электронная почта: org@eplast1.ru

Адрес: 198099, г. Санкт-Петербург, ул. Калинина, дом 2, корпус 4, литера А.