

IEC Appliance Inlet C14 with Filter, Line Switch 1- or 2-pole, Front or Rear Side Mounting



Screw-on mounting
from front side



Snap-in version
from front side



Screw-on mounting
from front side, protection class II



See below:
[Approvals and Compliances](#)

Description

- Panel mount :
Screw-on version from front or rear side, snap-in version from front side
- 3 Functions :
Appliance Inlet protection class I or II , Line Switch 1- or 2-pole , Line filter in standard and medical version
- Quick connect terminals 6.3 x 0.8 mm

Unique Selling Proposition

- Compact power entry module
- Available in white or black
- Switch for high inrush current
- V-Lock cord retaining

Characteristics

- Compact design with optimal shielding
- Rear side mounting for efficient cost-saving assembly
- All single elements are already wired
- Line switch non-illuminated or illuminated
- Universal line filter for standard applications
- Ideal for application with high transient loads
- For applications according IEC/UL 62368-1 we recommend variants with bleed resistor
- Suitable for use in medical equipment according to IEC/UL 60601-1

Other versions on request

- Solder terminals
- Other rocker marking
- Capacitance CX1

References

Alternative: version without line filter [DC11](#)
 Substitute for type [KFB1](#); [KFB2](#)

Weblinks

[pdf data sheet](#), [html datasheet](#), [General Product Information](#), [Approvals](#), [Distributor-Stock-Check](#), [Accessories](#), [Detailed request for product](#), [Landing Page](#)

Newly available variants corresponding to V-Lock mating cordset. The connector is equipped with a notch intended for use with the latching cordset. The cord latching system prevents against accidental removal of the cordset.

Technical Data

Ratings IEC	1 - 10A @ Ta 40 °C / 250VAC; 50Hz	Appliance inlet/-outlet	C14 / C18 acc. to IEC 60320-1, UL 498, CSA C22.2 no. 42 (for cold conditions) pin-temperature 70 °C, 10A, Protection Class I or II
Ratings UL/CSA	1 - 10A @ Ta 40 °C / 250VAC; 60Hz	Line Switch	Rocker switch 1 or 2 pole, non-illuminated or illuminated, acc. to IEC 61058-1 Technical Details
Leakage Current	standard < 0.5mA (250V / 60Hz) medical < 5 µA (250 V / 60 Hz)	Line Filter	Standard and Medical Version, IEC 60939, UL 1283, CSA C22.2 no. 8 Technical Details
Dielectric Strength	> 1.7kVDC between L-N > 2.7kVDC between L/N-PE Test voltage (2 sec)	MTBF	> 1'900'000h acc. to MIL-HB-217 F
Allowable Operation Temperature	-25 °C to 85 °C		
Climatic Category	25/085/21 acc. to IEC 60068-1		
IP-Protection	from front side IP40 acc. to IEC 60529		
Protection Class	Suitable for appliances with protection class I or II acc. to IEC 61140		
Terminal	Quick connect terminals 6.3 x 0.8 mm		
Panel Thickness S	Screw: max 8 mm Mounting screw torque max 0.5Nm Snap-in: 1 mm to 3 mm		
Material: Housing	Thermoplastic, black / white, UL 94V-0		

Approvals and Compliances



Detailed information on product approvals, code requirements, usage instructions and detailed test conditions can be looked up in [Details about Approvals](#)

SCHURTER products are designed for use in industrial environments. They have approvals from independent testing bodies according to national and international standards. Products with specific characteristics and requirements such as required in the automotive sector according to IATF 16949, medical technology according to ISO 13485 or in the aerospace industry can be offered exclusively with customer-specific, individual agreements by SCHURTER.

Approvals







The approval mark is used by the testing authorities to certify compliance with the safety requirements placed on electronic products.

Approval Reference Type: DC12

Approval Logo	Certificates	Certification Body	Description
	VDE Approvals	VDE	Certificate Number: 40001522
	UL Approvals	UL	UL File Number: E72928
	CQC Approvals	CQC	CQC Certificate Number: CQC18001188116



Product standards

Product standards that are referenced

Organization	Design	Standard	Description
	Designed according to	IEC 60320-1	Appliance couplers for household and similar general purposes
	Designed according to	IEC 60939	Passive filters for suppressing electromagnetic interference
	Designed according to	IEC 61058-1	Switches for appliances. Part 1. General requirements
	Designed according to	UL 498	Standard for Attachment Plugs and Receptacles
	Designed according to	UL 1283	Electromagnetic interference filters
	Designed according to	CSA C22.2 no. 42	General Use Receptacles, Attachment Plugs, and Similar Wiring Devices
	Designed according to	CSA C22.2 no. 8	Electromagnetic interference (EMI) filters







Application standards

Application standards where the product can be used

Organization	Design	Standard	Description
	Designed for applications acc.	IEC/UL 62368-1	IEC 62368-1 includes the basic requirements for safety of audio, video, information technology and office equipment.
	Designed for applications acc.	IEC 60601-1	Medical electrical equipment - Part 1: General requirements for basic safety and essential performance

Compliances

The product complies with following Guide Lines

Identification	Details	Initiator	Description
	CE declaration of conformity	SCHURTER AG	The CE marking declares that the product complies with the applicable requirements laid down in the harmonisation of Community legislation on its affixing in accordance with EU Regulation 765/2008.
	RoHS	SCHURTER AG	Directive RoHS 2011/65/EU, Amendment (EU) 2015/863
	China RoHS	SCHURTER AG	The law SJ / T 11363-2006 (China RoHS) has been in force since 1 March 2007. It is similar to the EU directive RoHS.
	REACH	SCHURTER AG	On 1 June 2007, Regulation (EC) No 1907/2006 on the Registration, Evaluation, Authorization and Restriction of Chemicals 1 (abbreviated as "REACH") entered into force.
	Landing Page V-Lock	SCHURTER AG	V-Lock system are based on a matching plug-dose combination. The connector is equipped with a notch intended for use with the latching cordset. The cord latching system prevents against accidental removal of the cordset.
	Medical Technology	SCHURTER AG	Suitable for use in medical equipment according to IEC/UL 60601-1

Dimension [mm]

Screw-on mounting from front side

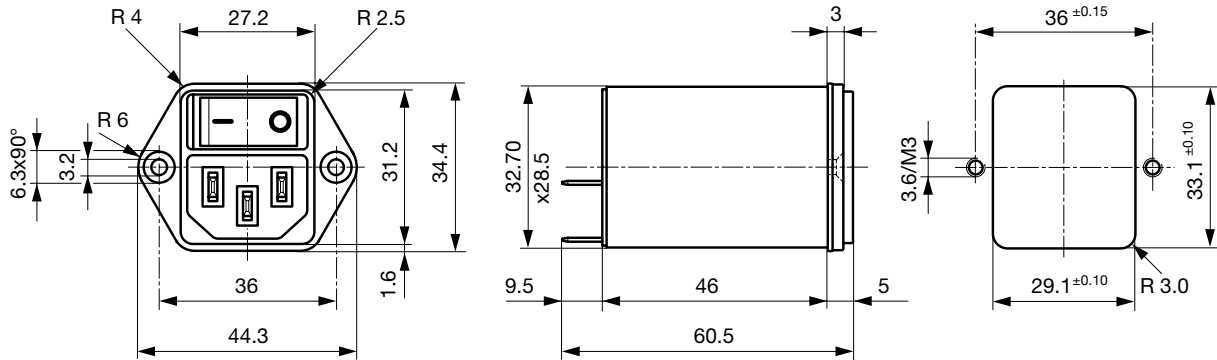

Screw-on mounting from rearside (metal flange)

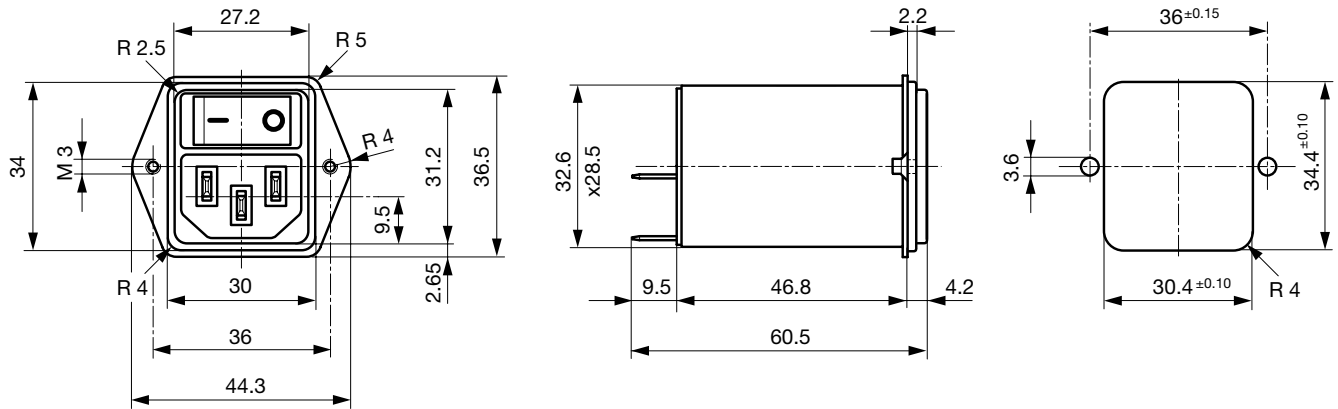

Snap-in mounting from front side

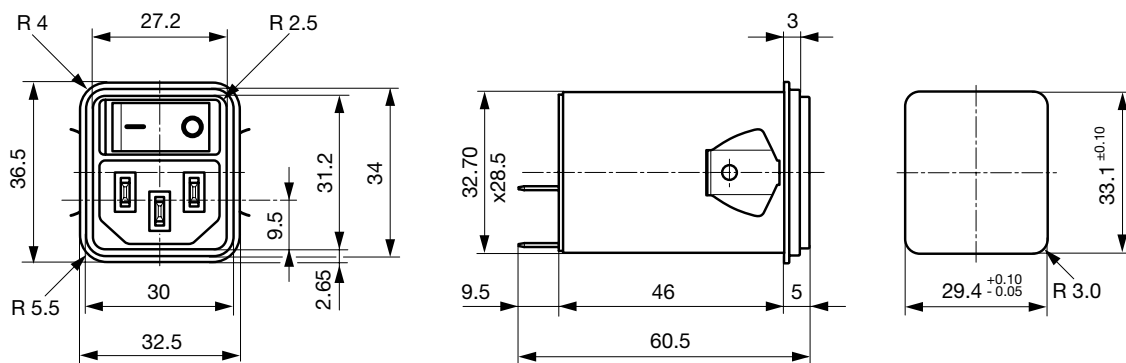

Screw-on mounting from front side (protection class II)

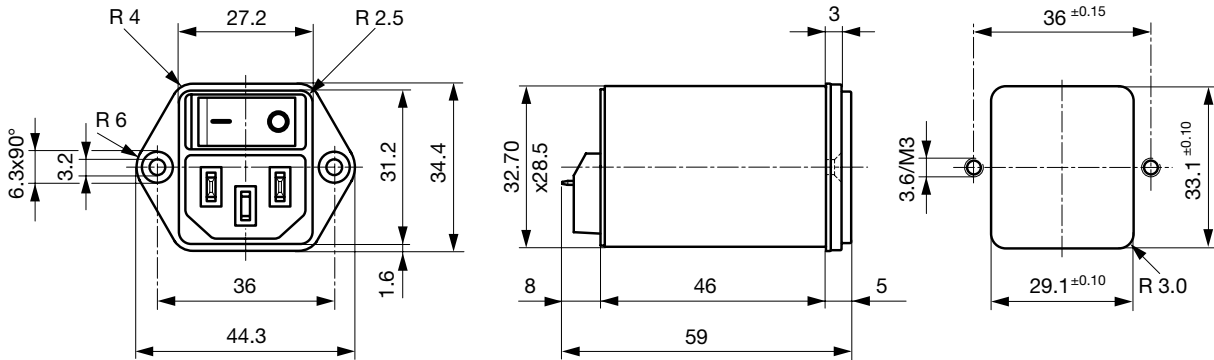

Screw-on mounting from rearside (protection class II)

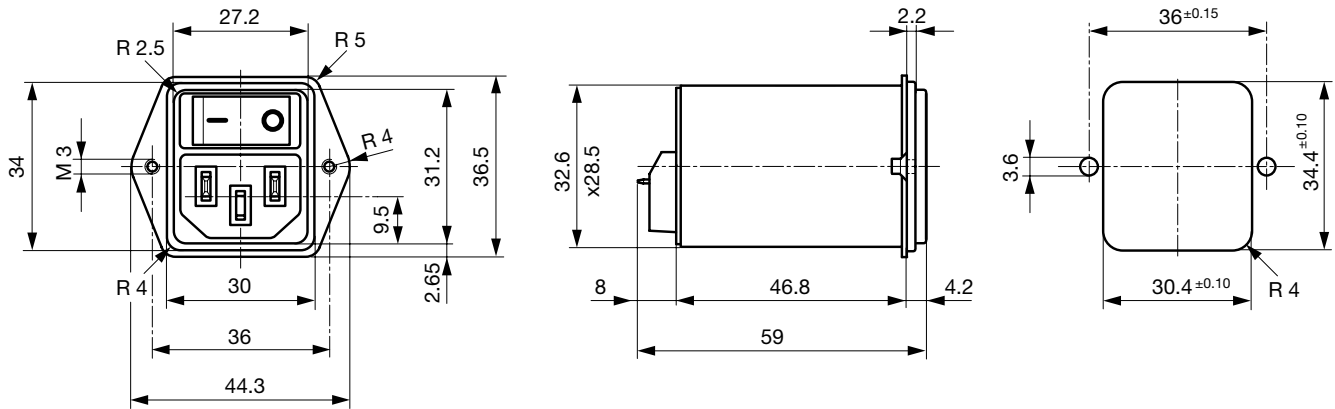

Snap-in mounting from front side (protection class II)

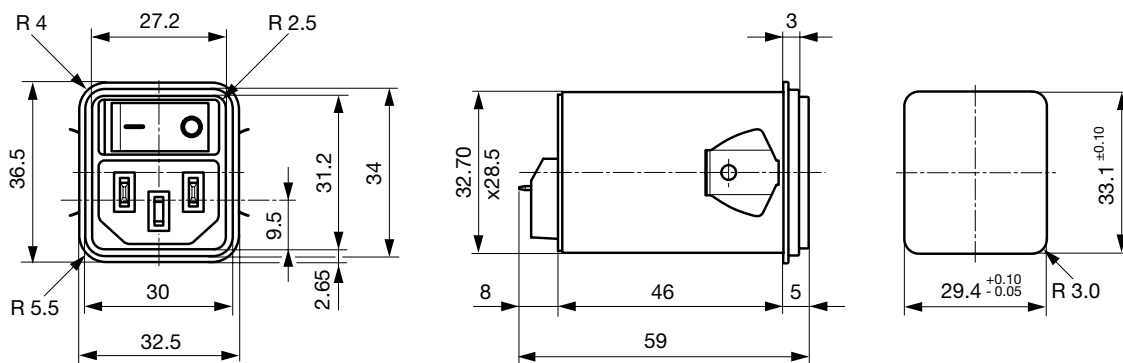

Technical Data of Filter-Components

Rated Current [A]	Filter-Type	Inductances L [mH]	Capacitance CX [nF]	Capacitance CY [nF]	R [MΩ]
1	Standard version	2 x 10	100	2.2	1
2	Standard version	2 x 4	100	2.2	1
4	Standard version	2 x 1.5	100	2.2	1
6	Standard version	2 x 0.8	100	2.2	1
10	Standard version	2 x 0.3	100	2.2	1
1	Medical Version (M5)	2 x 10	100	-	1
2	Medical Version (M5)	2 x 4	100	-	1
4	Medical Version (M5)	2 x 1.5	100	-	1
6	Medical Version (M5)	2 x 0.8	100	-	1
10	Medical Version (M5)	2 x 0.3	100	-	1
1	Medical Version (M80)	2 x 10	100	0.47	1
2	Medical Version (M80)	2 x 4	100	0.47	1
4	Medical Version (M80)	2 x 1.5	100	0.47	1
6	Medical Version (M80)	2 x 0.8	100	0.47	1
10	Medical Version (M80)	2 x 0.3	100	0.47	1

Diagrams

Standard filter 1-pole

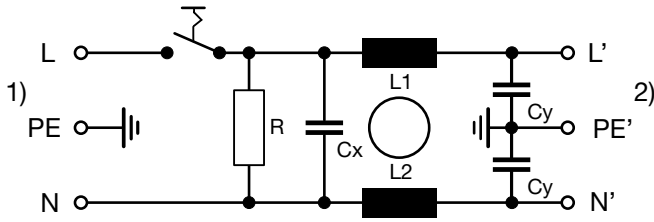

1) Line
 2) Load

Standard filter 2-pole

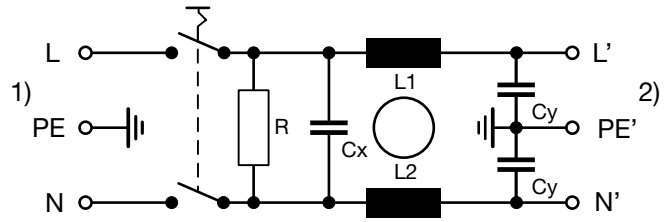

1) Line
 2) Load

Medical filter 1-pole (M5)

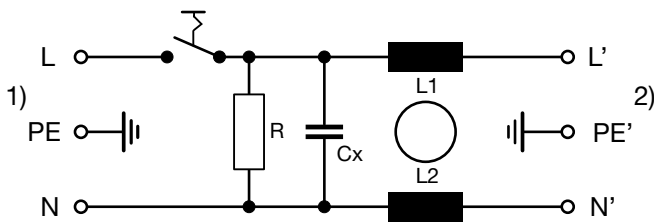

1) Line
 2) Load

Medical Version (M5)
 2-pole

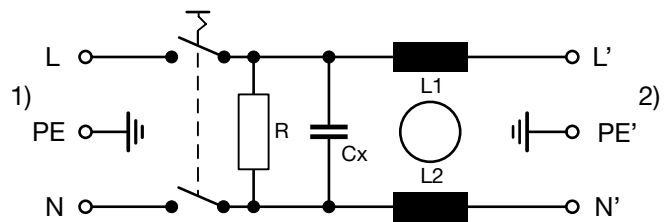

1) Line
 2) Load

Standard filter 2-pole illuminated

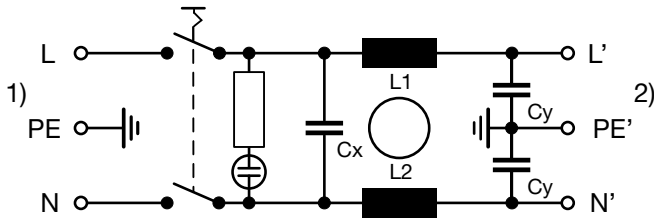

1) Line
 2) Load

Medical Filter 2-pole (M5)
 illuminated

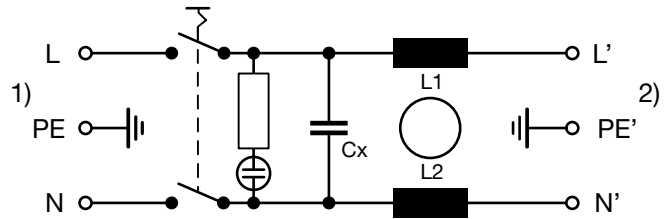

1) Line
 2) Load

Medical filter 2-pole (M5) protection class II

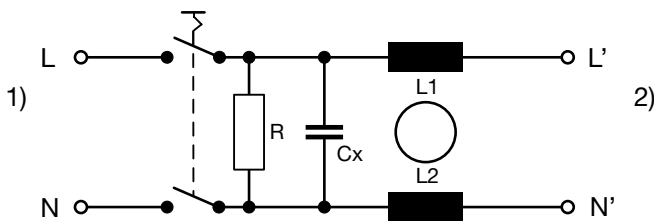

1) Line
 2) Load

Attenuation Loss

--- 50Ω differential mode ____ 50Ω common mode

Standard version

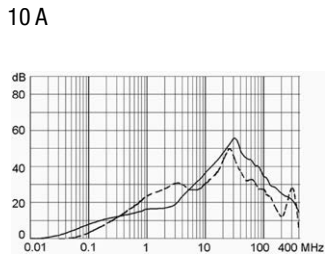
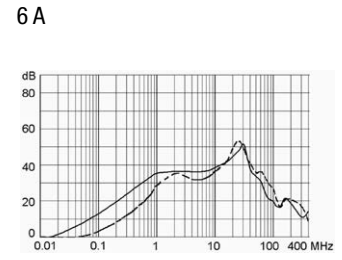
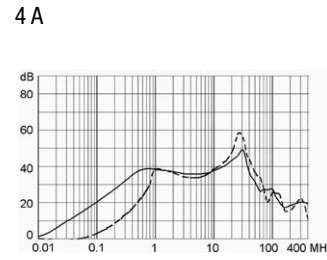
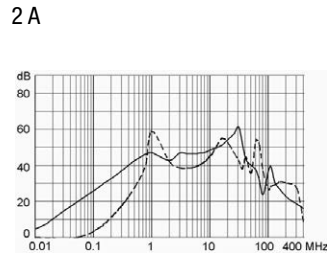
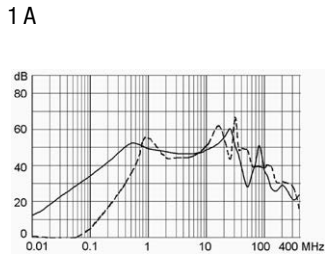

Medical version (M5)

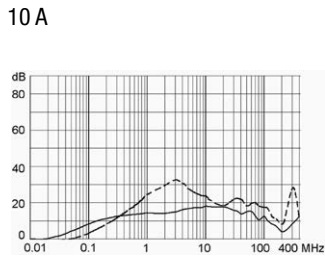
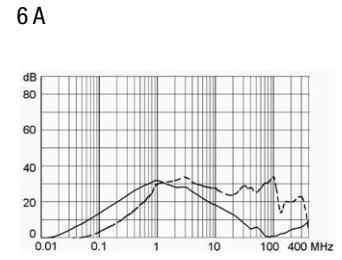
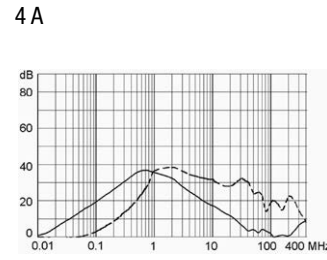
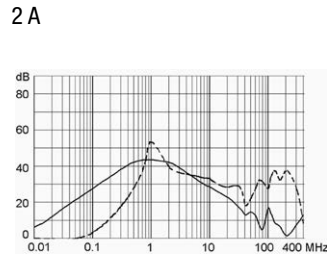
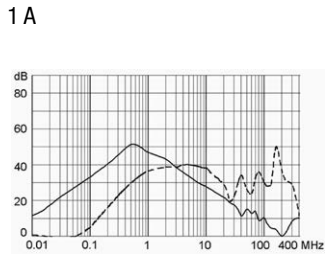

All Variants

Rated current	Filter-Type	Panel mounting	Mounting side	Line Switch	Illumination	Color	Pro-tection	V-Lock	Order Number
1	Standard version	Snap-in	Front Side	1-pole	non-illuminated	black		●	DC12.1102.103
2	Standard version	Snap-in	Front Side	1-pole	non-illuminated	black		●	DC12.2102.103
4	Standard version	Snap-in	Front Side	1-pole	non-illuminated	black		●	DC12.3102.103
6	Standard version	Snap-in	Front Side	1-pole	non-illuminated	black		●	DC12.4102.103
10	Standard version	Snap-in	Front Side	1-pole	non-illuminated	black		●	DC12.5102.103
1	Standard version	Snap-in	Front Side	2-pole	non-illuminated	black		●	DC12.1102.101
2	Standard version	Snap-in	Front Side	2-pole	non-illuminated	black		●	DC12.2102.101
4	Standard version	Snap-in	Front Side	2-pole	non-illuminated	black		●	DC12.3102.101
6	Standard version	Snap-in	Front Side	2-pole	non-illuminated	black		●	DC12.4102.101
10	Standard version	Snap-in	Front Side	2-pole	non-illuminated	black		●	DC12.5102.101
1	Standard version	Screw	Front Side	1-pole	non-illuminated	black		●	DC12.1102.003
2	Standard version	Screw	Front Side	1-pole	non-illuminated	black		●	DC12.2102.003
4	Standard version	Screw	Front Side	1-pole	non-illuminated	black		●	DC12.3102.003

Rated current	Filter-Type	Panel mounting	Mounting side	Line Switch	Illumination	Color	Pro-tection	V-Lock	Order Number
6	Standard version	Screw	Front Side	1-pole	non-illuminated	black	I	●	DC12.4102.003
10	Standard version	Screw	Front Side	1-pole	non-illuminated	black	I	●	DC12.5102.003
1	Standard version	Screw	Front Side	2-pole	non-illuminated	black	I	●	DC12.1102.001
2	Standard version	Screw	Front Side	2-pole	non-illuminated	black	I	●	DC12.2102.001
4	Standard version	Screw	Front Side	2-pole	non-illuminated	black	I	●	DC12.3102.001
6	Standard version	Screw	Front Side	2-pole	non-illuminated	black	I	●	DC12.4102.001
10	Standard version	Screw	Front Side	2-pole	non-illuminated	black	I	●	DC12.5102.001
1	Standard version	Screw	Rear Side	1-pole	non-illuminated	black	I	●	DC12.1102.203
2	Standard version	Screw	Rear Side	1-pole	non-illuminated	black	I	●	DC12.2102.203
4	Standard version	Screw	Rear Side	1-pole	non-illuminated	black	I	●	DC12.3102.203
6	Standard version	Screw	Rear Side	1-pole	non-illuminated	black	I	●	DC12.4102.203
10	Standard version	Screw	Rear Side	1-pole	non-illuminated	black	I	●	DC12.5102.203
1	Standard version	Screw	Rear Side	2-pole	non-illuminated	black	I	●	DC12.1102.201
2	Standard version	Screw	Rear Side	2-pole	non-illuminated	black	I	●	DC12.2102.201
4	Standard version	Screw	Rear Side	2-pole	non-illuminated	black	I	●	DC12.3102.201
6	Standard version	Screw	Rear Side	2-pole	non-illuminated	black	I	●	DC12.4102.201
10	Standard version	Screw	Rear Side	2-pole	non-illuminated	black	I	●	DC12.5102.201
1	Medical Version (M5)	Snap-in	Front Side	1-pole	non-illuminated	black	I	●	DC12.1202.103
2	Medical Version (M5)	Snap-in	Front Side	1-pole	non-illuminated	black	I	●	DC12.2202.103
4	Medical Version (M5)	Snap-in	Front Side	1-pole	non-illuminated	black	I	●	DC12.3202.103
6	Medical Version (M5)	Snap-in	Front Side	1-pole	non-illuminated	black	I	●	DC12.4202.103
10	Medical Version (M5)	Snap-in	Front Side	1-pole	non-illuminated	black	I	●	DC12.5202.103
1	Medical Version (M5)	Snap-in	Front Side	2-pole	non-illuminated	black	I	●	DC12.1202.101
1	Medical Version (M5)	Snap-in	Front Side	2-pole	non-illuminated	black	II	●	DC12.1202.121
1	Medical Version (M5)	Snap-in	Front Side	2-pole	non-illuminated	white	II	●	DC12.1202.131
2	Medical Version (M5)	Snap-in	Front Side	2-pole	non-illuminated	black	I	●	DC12.2202.101
2	Medical Version (M5)	Snap-in	Front Side	2-pole	non-illuminated	black	II	●	DC12.2202.121
2	Medical Version (M5)	Snap-in	Front Side	2-pole	non-illuminated	white	II	●	DC12.2202.131
4	Medical Version (M5)	Snap-in	Front Side	2-pole	non-illuminated	black	I	●	DC12.3202.101
4	Medical Version (M5)	Snap-in	Front Side	2-pole	non-illuminated	black	II	●	DC12.3202.121
4	Medical Version (M5)	Snap-in	Front Side	2-pole	non-illuminated	white	II	●	DC12.3202.131
6	Medical Version (M5)	Snap-in	Front Side	2-pole	non-illuminated	black	I	●	DC12.4202.101
6	Medical Version (M5)	Snap-in	Front Side	2-pole	non-illuminated	black	II	●	DC12.4202.121
6	Medical Version (M5)	Snap-in	Front Side	2-pole	non-illuminated	white	II	●	DC12.4202.131
10	Medical Version (M5)	Snap-in	Front Side	2-pole	non-illuminated	black	I	●	DC12.5202.101
10	Medical Version (M5)	Snap-in	Front Side	2-pole	non-illuminated	black	II	●	DC12.5202.121
10	Medical Version (M5)	Snap-in	Front Side	2-pole	non-illuminated	white	II	●	DC12.5202.131
6	Medical Version (M5)	Snap-in	Front Side	2-pole	illuminated green	black	I	●	DC12.4232.101
1	Medical Version (M5)	Screw	Front Side	1-pole	non-illuminated	black	I	●	DC12.1202.003
2	Medical Version (M5)	Screw	Front Side	1-pole	non-illuminated	black	I	●	DC12.2202.003
4	Medical Version (M5)	Screw	Front Side	1-pole	non-illuminated	black	I	●	DC12.3202.003
6	Medical Version (M5)	Screw	Front Side	1-pole	non-illuminated	black	I	●	DC12.4202.003
10	Medical Version (M5)	Screw	Front Side	1-pole	non-illuminated	black	I	●	DC12.5202.003
1	Medical Version (M5)	Screw	Front Side	2-pole	non-illuminated	black	I	●	DC12.1202.001
1	Medical Version (M5)	Screw	Front Side	2-pole	non-illuminated	black	II	●	DC12.1202.021
1	Medical Version (M5)	Screw	Front Side	2-pole	non-illuminated	white	II	●	DC12.1202.031
2	Medical Version (M5)	Screw	Front Side	2-pole	non-illuminated	black	I	●	DC12.2202.001

Rated current	Filter-Type	Panel mounting	Mounting side	Line Switch	Illumination	Color	Pro-tection	V-Lock	Order Number
2	Medical Version (M5)	Screw	Front Side	2-pole	non-illuminated	black	II	●	DC12.2202.021
2	Medical Version (M5)	Screw	Front Side	2-pole	non-illuminated	white	II	●	DC12.2202.031
4	Medical Version (M5)	Screw	Front Side	2-pole	non-illuminated	black	I	●	DC12.3202.001
4	Medical Version (M5)	Screw	Front Side	2-pole	non-illuminated	black	II	●	DC12.3202.021
4	Medical Version (M5)	Screw	Front Side	2-pole	non-illuminated	white	II	●	DC12.3202.031
6	Medical Version (M5)	Screw	Front Side	2-pole	non-illuminated	black	I	●	DC12.4202.001
6	Medical Version (M5)	Screw	Front Side	2-pole	non-illuminated	black	II	●	DC12.4202.021
6	Medical Version (M5)	Screw	Front Side	2-pole	non-illuminated	white	II	●	DC12.4202.031
10	Medical Version (M5)	Screw	Front Side	2-pole	non-illuminated	black	I	●	DC12.5202.001
10	Medical Version (M5)	Screw	Front Side	2-pole	non-illuminated	black	II	●	DC12.5202.021
10	Medical Version (M5)	Screw	Front Side	2-pole	non-illuminated	white	II	●	DC12.5202.031
1	Medical Version (M5)	Screw	Rear Side	2-pole	non-illuminated	black	I	●	DC12.1202.201
2	Medical Version (M5)	Screw	Rear Side	2-pole	non-illuminated	black	I	●	DC12.2202.201
4	Medical Version (M5)	Screw	Rear Side	2-pole	non-illuminated	black	I	●	DC12.3202.201
6	Medical Version (M5)	Screw	Rear Side	2-pole	non-illuminated	black	I	●	DC12.4202.201
10	Medical Version (M5)	Screw	Rear Side	2-pole	non-illuminated	black	I	●	DC12.5202.201
1	Medical Version (M80)	Screw	Rear Side	2-pole	non-illuminated	black	I	●	DC12.1602.201
2	Medical Version (M80)	Screw	Rear Side	2-pole	non-illuminated	black	I	●	DC12.2602.201
4	Medical Version (M80)	Screw	Rear Side	2-pole	non-illuminated	black	I	●	DC12.3602.201
6	Medical Version (M80)	Screw	Rear Side	2-pole	non-illuminated	black	I	●	DC12.4602.201
10	Medical Version (M80)	Screw	Rear Side	2-pole	non-illuminated	black	I	●	DC12.5602.201

Most Popular.

Availability for all products can be searched real-time: <https://www.schurter.com/en/Stock-Check/Stock-Check-SCHURTER>

Packaging unit 10 Pcs

Accessories

Description



Wire Harness
 Wire harness for SCHURTER products



Cord retaining kits
 Cord retaining strain relief

Flat head, A	4700.0001
Countersunk, B	4700.0002

Mating Outlets/Connectors

Category / Description

[Connector Overview complete](#)



4782 Mounting: Power Cord, 3 x 1 mm ² / 3 x 18 AWG, Cable, Connector: IEC C13	4782
4785 Mounting: Power Cord, 3 x 1 mm ² / 3 x 18 AWG, Cable, Connector: IEC C13	4785
4012 Mounting: Power Supply Cord, 3 x 1 mm ² , Screw clamps, Connector: IEC C13	4012
4300-06 Mounting: Power Cord, 3 x 1 mm ² / 3 x 18 AWG, Cable, Connector: IEC C13	4300-06
4781 Mounting: Power Cord, 3 x 1 mm ² / 3 x 18 AWG, Cable, Connector: IEC C15	4781
Connector further types to DC12	...

[Interconnection Cord Overview complete](#)



Cord Sets 10 A, Interconnection, 1.0 m, Connector IEC C13, H05VV-F3G1.0, black	6007.0212
Cord Sets 10 A, Interconnection, 2.0 m, Connector IEC C13, H05VV-F3G1.0, black	6007.0214
Interconnection Cord further types to DC12	...

[Power Supply Cord Overview complete](#)



Cord Sets 10 A, Europlug, 2.0 m, Connector IEC C13, H05VV-F3G0.75, black	6004.0114
Cord Sets 10 A, Europlug, 2.5 m, Connector IEC C13, H05VV-F3G1.0, black	6004.0215
Cord Sets 10 A, Europlug, 2.5 m, Connector IEC C13, H05VV-F3G1.0, black	6003.0215
Cord Sets 10 A, Europlug, Black, 2.5 m, H05VV-F 3G1,0mm2, Connector IEC C13, 002500 mm, H05VV-F3G1.0, black	6004.0225
Cord Sets 10 A, diverse, Black, 5.0 m, H05VV-F 3G1,0mm2, Connector IEC C13, 002500 mm, H05VV-F3G1.0, black	6052.0026
Power Supply Cord further types to DC12	...

Mating Outlets/Connectors shuttered

[Connector Overview complete](#)



4783 Mounting: Power Cord, 3 x 1 mm ² / 3 x 18 AWG, Cable, Connector: IEC C13	4783
Connector further types to DC12	...

[Power Cord Overview complete](#)



VAC13KS, Overview, V-Lock cord retaining, diverse Connector IEC C13, diverse, black	VAC13KS
VAC17KS, V-Lock cord retaining, diverse m, Connector IEC C17, diverse, black / grey / white	VAC17KS
Power Cord further types to DC12	...



Компания «ЭлектроПласт» предлагает заключение долгосрочных отношений при поставках импортных электронных компонентов на взаимовыгодных условиях!

Наши преимущества:

- Оперативные поставки широкого спектра электронных компонентов отечественного и импортного производства напрямую от производителей и с крупнейших мировых складов;
- Поставка более 17-ти миллионов наименований электронных компонентов;
- Поставка сложных, дефицитных, либо снятых с производства позиций;
- Оперативные сроки поставки под заказ (от 5 рабочих дней);
- Экспресс доставка в любую точку России;
- Техническая поддержка проекта, помощь в подборе аналогов, поставка прототипов;
- Система менеджмента качества сертифицирована по Международному стандарту ISO 9001;
- Лицензия ФСБ на осуществление работ с использованием сведений, составляющих государственную тайну;
- Поставка специализированных компонентов (Xilinx, Altera, Analog Devices, Intersil, Interpoint, Microsemi, Aeroflex, Peregrine, Syfer, Eurofarad, Texas Instrument, Miteq, Cobham, E2V, MA-COM, Hittite, Mini-Circuits, General Dynamics и др.);

Помимо этого, одним из направлений компании «ЭлектроПласт» является направление «Источники питания». Мы предлагаем Вам помощь Конструкторского отдела:

- Подбор оптимального решения, техническое обоснование при выборе компонента;
- Подбор аналогов;
- Консультации по применению компонента;
- Поставка образцов и прототипов;
- Техническая поддержка проекта;
- Защита от снятия компонента с производства.



Как с нами связаться

Телефон: 8 (812) 309 58 32 (многоканальный)

Факс: 8 (812) 320-02-42

Электронная почта: org@eplast1.ru

Адрес: 198099, г. Санкт-Петербург, ул. Калинина, дом 2, корпус 4, литера А.