

PART NO.	ENG. NO.	INTERLEAF PAPER OPTION
02-09-1104	1189-A(P901)L	
02-09-1102	1189-A(P901)	
02-09-5111	1189-A(P591)L	
02-09-5102	1189-A(P591)	
02-09-5106	1189-A(P550)L	
02-09-5100	1189-A(P550)	
02-09-6102	1189-A(P901)-I	YES

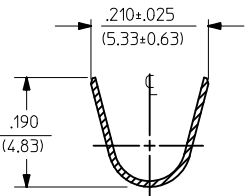

SECT. "A-A"

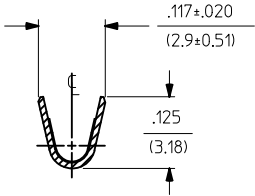

SECT. "B-B"

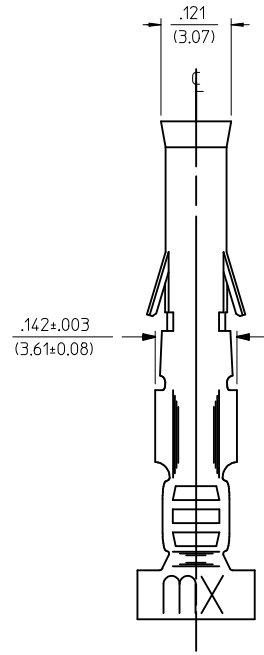
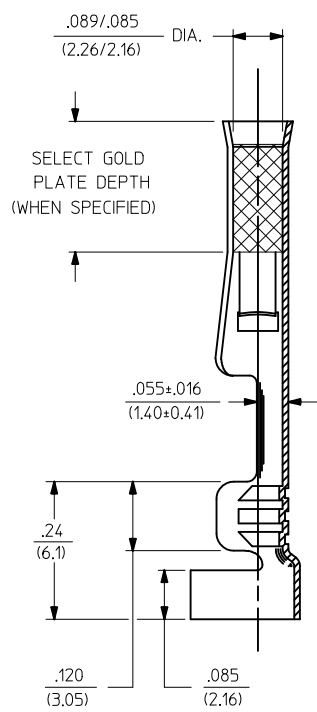
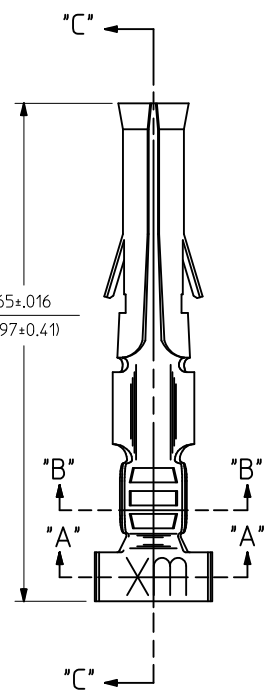
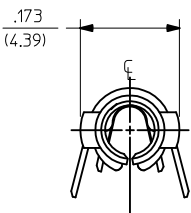
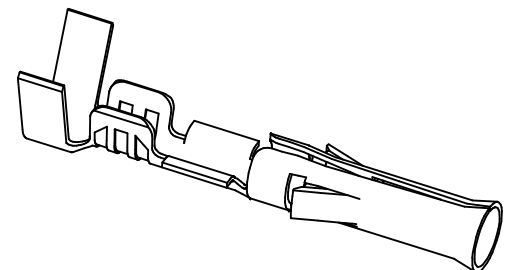

SECT. "C-C"



LEGEND

1189-A(****)*-*
 INTERLEAF PAPER OPTION
 FORM: BLANK=CHAIN, L=LOOSE
 FINISH CODE: P=PREPLATE, BLANK=POSTPLATE
 BLANK: INTERLEAF PAPER ON FIRST FEW WRAPS ONLY.
 I: INTERLEAF PAPER THROUGH OUT REEL.

- NOTES:
- MATERIAL: CARTRIDGE BRASS, ALLOY #C26000, .010/(0.25) THICK
 - FINISH CODES:
 - 901 HOT TIN DIP .000020/(0.00051) MIN.
 - 591 SELECT GOLD PLATE .000050/(0.00127) MIN. IN CONTACT AREA, OVER .000050/(0.00127) MIN. NICKEL OVERALL WITH .000010/(0.00025) MAX. GOLD FLASH OVERALL.
 - 550 SELECT GOLD PLATE .000015/(0.00038) MIN. IN CONTACT AREA, OVER .000030/(0.00076) MIN. NICKEL OVERALL WITH .000010/(0.00025) MAX. GOLD FLASH OVERALL.

*THE PRIMARY SHIPPING CARTON WILL BE LABELED, "COMPLIANT TO RoHS DIRECTIVE 2002/95/EC AND ELV ANNEX OF DIRECTIVE 2000/53/EC", AND CARTONS WITHOUT THIS LABEL MAY CONTAIN PRODUCT WITH TIN-LEAD.

- THIS PART CONFORMS TO PROD. SPEC. 02-09.
- PACKAGING INFORMATION: NOT AVAILABLE
- TERMINAL FOR USE WITH .093/(2.36) SERIES HOUSINGS AND WILL ACCEPT 14 THRU 20 AWG WIRE.
- INSERTION FORCE: 3.5 LBS. MAX. WHEN TERMINAL IS INSERTED INTO AN .093 SERIES HOUSING.
- RETENTION: 20 LBS. MIN. FROM HOUSING.

ADD P/N 02-09-6102 EC NO: UCP2012-2714 DRW:NAELHAG CHKD:JBELL APPR:FSMITH	2012/02/20 2012/02/22 2012/04/25	DESCRIPTION REV	QUALITY SYMBOLS ▽=0 ▽=0	GENERAL TOLERANCES (UNLESS SPECIFIED)	DIMENSION STYLE IN/MM	SCALE 6:1	DESIGN UNITS INCH	THIRD ANGLE PROJECTION																													
			<table border="1"> <thead> <tr> <th></th> <th>mm</th> <th>INCH</th> </tr> </thead> <tbody> <tr> <td>4 PLACES ± ---</td> <td>± ---</td> <td>± ---</td> </tr> <tr> <td>3 PLACES ± ---</td> <td>± .010</td> <td>± .010</td> </tr> <tr> <td>2 PLACES ± 0.25</td> <td>± .014</td> <td>± .014</td> </tr> <tr> <td>1 PLACE ± 0.35</td> <td>± ---</td> <td>± ---</td> </tr> </tbody> </table>		mm	INCH	4 PLACES ± ---	± ---	± ---	3 PLACES ± ---	± .010	± .010	2 PLACES ± 0.25	± .014	± .014	1 PLACE ± 0.35	± ---	± ---	<table border="1"> <thead> <tr> <th>mm</th> <th>INCH</th> </tr> </thead> <tbody> <tr> <td>ANGULAR ±1/2°</td> <td></td> </tr> </tbody> </table>	mm	INCH	ANGULAR ±1/2°		<table border="1"> <thead> <tr> <th>DRAWN BY</th> <th>DATE</th> </tr> </thead> <tbody> <tr> <td>GEP</td> <td>1987/10/26</td> </tr> <tr> <th>CHECKED BY</th> <th>DATE</th> </tr> <tr> <td>RW</td> <td>1987/10/26</td> </tr> <tr> <th>APPROVED BY</th> <th>DATE</th> </tr> <tr> <td>RAS</td> <td>1987/10/26</td> </tr> </tbody> </table>	DRAWN BY	DATE	GEP	1987/10/26	CHECKED BY	DATE	RW	1987/10/26	APPROVED BY	DATE	RAS	1987/10/26	TITLE CRIMP TERMINAL, FEMALE, .093/(2.36) DIA. 14-20 AWG
	mm	INCH																																			
4 PLACES ± ---	± ---	± ---																																			
3 PLACES ± ---	± .010	± .010																																			
2 PLACES ± 0.25	± .014	± .014																																			
1 PLACE ± 0.35	± ---	± ---																																			
mm	INCH																																				
ANGULAR ±1/2°																																					
DRAWN BY	DATE																																				
GEP	1987/10/26																																				
CHECKED BY	DATE																																				
RW	1987/10/26																																				
APPROVED BY	DATE																																				
RAS	1987/10/26																																				

THIS DRAWING CONTAINS INFORMATION THAT IS PROPRIETARY TO MOLEX INCORPORATED AND SHOULD NOT BE USED WITHOUT WRITTEN PERMISSION



Компания «ЭлектроПласт» предлагает заключение долгосрочных отношений при поставках импортных электронных компонентов на взаимовыгодных условиях!

Наши преимущества:

- Оперативные поставки широкого спектра электронных компонентов отечественного и импортного производства напрямую от производителей и с крупнейших мировых складов;
- Поставка более 17-ти миллионов наименований электронных компонентов;
- Поставка сложных, дефицитных, либо снятых с производства позиций;
- Оперативные сроки поставки под заказ (от 5 рабочих дней);
- Экспресс доставка в любую точку России;
- Техническая поддержка проекта, помощь в подборе аналогов, поставка прототипов;
- Система менеджмента качества сертифицирована по Международному стандарту ISO 9001;
- Лицензия ФСБ на осуществление работ с использованием сведений, составляющих государственную тайну;
- Поставка специализированных компонентов (Xilinx, Altera, Analog Devices, Intersil, Interpoint, Microsemi, Aeroflex, Peregrine, Syfer, Eurofarad, Texas Instrument, Miteq, Cobham, E2V, MA-COM, Hittite, Mini-Circuits, General Dynamics и др.);

Помимо этого, одним из направлений компании «ЭлектроПласт» является направление «Источники питания». Мы предлагаем Вам помощь Конструкторского отдела:

- Подбор оптимального решения, техническое обоснование при выборе компонента;
- Подбор аналогов;
- Консультации по применению компонента;
- Поставка образцов и прототипов;
- Техническая поддержка проекта;
- Защита от снятия компонента с производства.



Как с нами связаться

Телефон: 8 (812) 309 58 32 (многоканальный)

Факс: 8 (812) 320-02-42

Электронная почта: org@eplast1.ru

Адрес: 198099, г. Санкт-Петербург, ул. Калинина, дом 2, корпус 4, литера А.