

Voltage Detector IC Series

# Counter Timer Built-in CMOS Voltage Detector IC

**BU45Kxxxx, BU46Kxxxx, BU45Lxxxx, BU46Lxxxx series**

● **General Description**

ROHM's BU45xxxx and BU46xxxx series are highly accurate, low current consumption voltage detector IC series. Because the counter timer delay circuit is built-in, an external capacitor for the delay time setting is unnecessary. Two output types are available (Nch open drain and CMOS output) and detection voltages range from 2.3V to 4.8V in increments of 0.1V with fixed delay time of 200ms and 400ms, that may be selected according to application.

● **Features**

- Counter Timer Built-in
- No delay time setting capacitor required
- Low current consumption
- Two output types (Nch open drain and CMOS output)
- Package SSOP3 is similar to SOT-23-3 (JEDEC)

● **Typical Application Circuit**



(Open Drain Output Type)  
BU45xxxx series

● **Key Specifications**

- Detection voltage: 2.3V to 4.8V (Typ.)  
0.1V steps
- High accuracy detection voltage: ±1.0%
- Low current consumption: 2.3µA (Typ.)
- Operating temperature range: -40°C to +105°C
- Two internal, fixed delay time: 200ms  
400ms

● **Package**

SSOP3



2.92mm x 2.80mm x 1.25mm

● **Applications**

Circuits using microcontrollers or logic circuits that require a reset



(CMOS Output Type)  
BU46xxxx series

● **Connection Diagram**

SSOP3



● **Pin Descriptions**

BU45KxxxG / BU46KxxxG

PIN No.	Symbol	Function
1	GND	GND
2	VOUT	Reset Output
3	VDD	Power Supply Voltage

BU45LxxxG / BU46LxxxG

PIN No.	Symbol	Function
1	VOUT	Reset Output
2	VDD	Power Supply Voltage
3	GND	GND

○Product structure : Silicon monolithic integrated circuit ○This product is not designed for protection against radioactive rays.

●Ordering Information

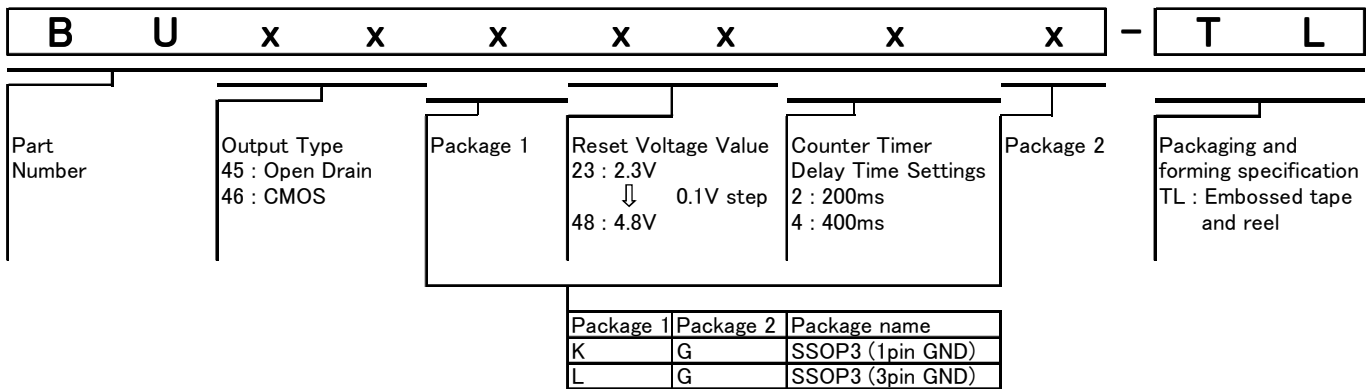

●Lineup

Table 1. Open Drain Output Type

	Counter Timer Delay Time Settings							
	1-Pin GND				3-Pin GND			
	200ms		400ms		200ms		400ms	
	Detection Voltage	Marking	Part Number	Marking	Part Number	Marking	Part Number	Marking
4.8V	bH	BU45K482	eF	BU45K484	hD	BU45L482	nB	BU45L484
4.7V	bG	BU45K472	eE	BU45K474	hC	BU45L472	nA	BU45L474
4.6V	bF	BU45K462	eD	BU45K464	hB	BU45L462	mY	BU45L464
4.5V	bE	BU45K452	eC	BU45K454	hA	BU45L452	mX	BU45L454
4.4V	bD	BU45K442	eB	BU45K444	gY	BU45L442	mW	BU45L444
4.3V	bC	BU45K432	eA	BU45K434	gX	BU45L432	mT	BU45L434
4.2V	bB	BU45K422	dY	BU45K424	gW	BU45L422	mS	BU45L424
4.1V	bA	BU45K412	dX	BU45K414	gT	BU45L412	mR	BU45L414
4.0V	aY	BU45K402	dW	BU45K404	gS	BU45L402	mP	BU45L404
3.9V	aX	BU45K392	dT	BU45K394	gR	BU45L392	mN	BU45L394
3.8V	aW	BU45K382	dS	BU45K384	gP	BU45L382	mM	BU45L384
3.7V	aT	BU45K372	dR	BU45K374	gN	BU45L372	mK	BU45L374
3.6V	aS	BU45K362	dP	BU45K364	gM	BU45L362	mH	BU45L364
3.5V	aR	BU45K352	dN	BU45K354	gK	BU45L352	mG	BU45L354
3.4V	aP	BU45K342	dM	BU45K344	gH	BU45L342	mF	BU45L344
3.3V	aN	BU45K332	dK	BU45K334	gG	BU45L332	mE	BU45L334
3.2V	aM	BU45K322	dH	BU45K324	gF	BU45L322	mD	BU45L324
3.1V	aK	BU45K312	dG	BU45K314	gE	BU45L312	mC	BU45L314
3.0V	aH	BU45K302	dF	BU45K304	gD	BU45L302	mB	BU45L304
2.9V	aG	BU45K292	dE	BU45K294	gC	BU45L292	mA	BU45L294
2.8V	aF	BU45K282	dD	BU45K284	gB	BU45L282	kY	BU45L284
2.7V	aE	BU45K272	dC	BU45K274	gA	BU45L272	kX	BU45L274
2.6V	aD	BU45K262	dB	BU45K264	fY	BU45L262	kW	BU45L264
2.5V	aC	BU45K252	dA	BU45K254	fX	BU45L252	kT	BU45L254
2.4V	aB	BU45K242	cY	BU45K244	fW	BU45L242	kS	BU45L244
2.3V	aA	BU45K232	cX	BU45K234	fT	BU45L232	kR	BU45L234

## ●Lineup - Continued

Table 2. CMOS Output Type

	Counter Timer Delay Time Settings							
	1-Pin GND				3-Pin GND			
	200ms		400ms		200ms		400ms	
	Marking	Part Number	Marking	Part Number	Marking	Part Number	Marking	Part Number
4.8V	cW	BU46K482	fS	BU46K484	kP	BU46L482	pM	BU46L484
4.7V	cT	BU46K472	fR	BU46K474	kN	BU46L472	pK	BU46L474
4.6V	cS	BU46K462	fP	BU46K464	kM	BU46L462	pH	BU46L464
4.5V	cR	BU46K452	fN	BU46K454	kK	BU46L452	pG	BU46L454
4.4V	cP	BU46K442	fM	BU46K444	kH	BU46L442	pF	BU46L444
4.3V	cN	BU46K432	fK	BU46K434	kG	BU46L432	pE	BU46L434
4.2V	cM	BU46K422	fH	BU46K424	kF	BU46L422	pD	BU46L424
4.1V	cK	BU46K412	fG	BU46K414	kE	BU46L412	pC	BU46L414
4.0V	cH	BU46K402	fF	BU46K404	kD	BU46L402	pB	BU46L404
3.9V	cG	BU46K392	fE	BU46K394	kC	BU46L392	pA	BU46L394
3.8V	cF	BU46K382	fD	BU46K384	kB	BU46L382	nY	BU46L384
3.7V	cE	BU46K372	fC	BU46K374	kA	BU46L372	nX	BU46L374
3.6V	cD	BU46K362	fB	BU46K364	hY	BU46L362	nW	BU46L364
3.5V	cC	BU46K352	fA	BU46K354	hX	BU46L352	nT	BU45L354
3.4V	cB	BU46K342	eY	BU46K344	hW	BU46L342	nS	BU46L344
3.3V	cA	BU46K332	eX	BU46K334	hT	BU46L332	nR	BU46L334
3.2V	bY	BU46K322	eW	BU46K324	hS	BU46L322	nP	BU46L324
3.1V	bX	BU46K312	eT	BU46K314	hR	BU46L312	nN	BU46L314
3.0V	bW	BU46K302	eS	BU46K304	hP	BU46L302	nM	BU46L304
2.9V	bT	BU46K292	eR	BU46K294	hN	BU46L292	nK	BU46L294
2.8V	bS	BU46K282	eP	BU46K284	hM	BU46L282	nH	BU46L284
2.7V	bR	BU46K272	eN	BU46K274	hK	BU46L272	nG	BU46L274
2.6V	bP	BU46K262	eM	BU46K264	hH	BU46L262	nF	BU46L264
2.5V	bN	BU46K252	eK	BU46K254	hG	BU46L252	nE	BU46L254
2.4V	bM	BU46K242	eH	BU46K244	hF	BU46L242	nD	BU46L244
2.3V	bK	BU46K232	eG	BU46K234	hE	BU46L232	nC	BU46L234

## ● Absolute maximum ratings (Ta=25°C)

Parameter	Symbol	Limit	Unit
Power Supply Voltage	VDD-GND	-0.3 to +6.0	V
Output Voltage	Nch Open Drain Output	GND-0.3 to +6.0	V
	CMOS Output	GND-0.3 to VDD+0.3	
Output Current	Io	70	mA
Power Dissipation (Note1, Note2)	Pd	700	mW
Operating Temperature	Topr	-40 to +105	°C
Ambient Storage Temperature	Tstg	-55 to +125	°C

(Note 1) Use above Ta=25°C results in a 7.0mW loss per degree.

(Note 2) When mounted on ROHM standard circuit board (70mmx70mmx1.6mm, glass epoxy board).

**Caution:** Operating the IC over the absolute maximum ratings may damage the IC. The damage can either be a short circuit between pins or an open circuit between pins and the internal circuitry. Therefore, it is important to consider circuit protection measures, such as adding a fuse, in case the IC is operated over the absolute maximum ratings.

## ● Electrical characteristics (Unless Otherwise Specified Ta=-40 to 105°C)

Parameter	Symbol	Condition	Limit			Unit		
			Min.	Typ.	Max.			
Operating Voltage Range	VOPL	VOL≤0.4V, RL=470kΩ, Ta=25~105°C	0.6	-	6.0	V		
		VOL≤0.4V, RL=470kΩ, Ta=-40~25°C	0.9	-	6.0			
Detection Voltage	VDET	VDD=H→L, RL=470kΩ (Note 1)	VDET(T) x0.99	VDET(T)	VDET(T) x1.01	V		
		VDET=2.5V	Ta=25°C	2.475	2.5		2.525	
			Ta=-40°C to 85°C	2.418	-		2.584	
			Ta=85°C to 105°C	2.404	-		2.597	
		VDET=3.0V	Ta=25°C	2.970	3.0		3.030	
			Ta=-40°C to 85°C	2.901	-		3.100	
			Ta=85°C to 105°C	2.885	-		3.117	
		VDET=3.3V	Ta=25°C	3.267	3.3		3.333	
			Ta=-40°C to 85°C	3.191	-		3.410	
			Ta=85°C to 105°C	3.173	-		3.428	
		VDET=4.2V	Ta=25°C	4.158	4.2		4.242	
			Ta=-40°C to 85°C	4.061	-		4.341	
Ta=85°C to 105°C	4.039		-	4.364				
VDET=4.8V	Ta=25°C	4.752	4.8	4.848				
	Ta=-40°C to 85°C	4.641	-	4.961				
	Ta=85°C to 105°C	4.616	-	4.987				
Detection Voltage Temperature coefficient	VDET/ΔT	-40°C~105°C	-	±50	±360	ppm/°C		
Hysteresis Voltage	ΔVDET	VDD=L→H→L, RL=470kΩ	VDET(T) x0.03	VDET(T) x0.05	VDET(T) x0.08	V		
'High' Output Delay time	tPLH	CL=100pF, RL=100kΩ ( Note1, Note 2, Note 3 )	BU4xxxx2G	Ta=25°C	120	200	280	ms
				Ta=-40°C to 85°C	95	-	460	
			Ta=85°C to 105°C	85	-	235		
			BU4xxxx4G	Ta=25°C	240	400	560	
				Ta=-40°C to 85°C	190	-	920	
				Ta=85°C to 105°C	170	-	470	
Circuit Current when ON	IDD1	VDD=VDET-0.2V, VDET=2.3V~4.8V	0.60	2.30	7.00	μA		
Circuit Current when OFF	IDD2	VDD=VDET+1.0V, VDET=2.3V~4.8V	1.10	2.80	8.00	μA		
'High' Output Voltage (Pch)	VOH	VDD=5.0V, ISOURCE= 6.8mA, VDET(4.3V to 4.8V)	VDD-0.5		-	V		
'Low' Output Voltage (Nch)	VOL	VDD=1.2V, ISINK= 2.0mA	-	-	0.3	V		
		VDD=2.4V, ISINK= 8.5mA, VDET(2.7V to 4.8V)	-	-	0.3	V		
Leak Current when OFF	Ileak	VDD=VDS=6.0V (Note 1)	-	-	1.0	μA		

VDET(T):Standard Detection Voltage (2.3V to 4.8V, 0.1V step)

RL :Pull-up resistor to be connected between VOUT and power supply.

CL :Capacitor to be connected between VOUT and GND.

(Note 1) Guarantee is Ta=25°C.

(Note 2) tPLH:VDD=(VDET(T)-0.5V)→(VDET(T)+0.5V)

(Note 3) tPLH:VDD=Please set up the rise up time between VDD=VOPL→VDET more than 10μs.

●Block Diagrams



Fig.1 BU45xxxx Series



Fig.2 BU46xxxx Series

● Typical Performance Curves

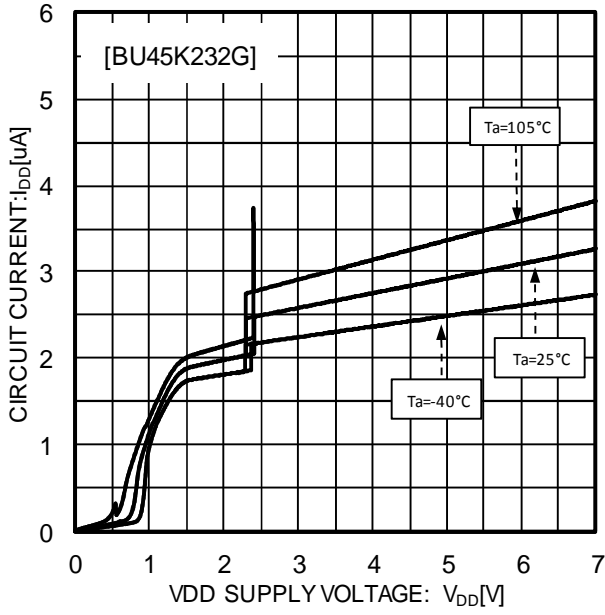

Fig.3 Circuit Current

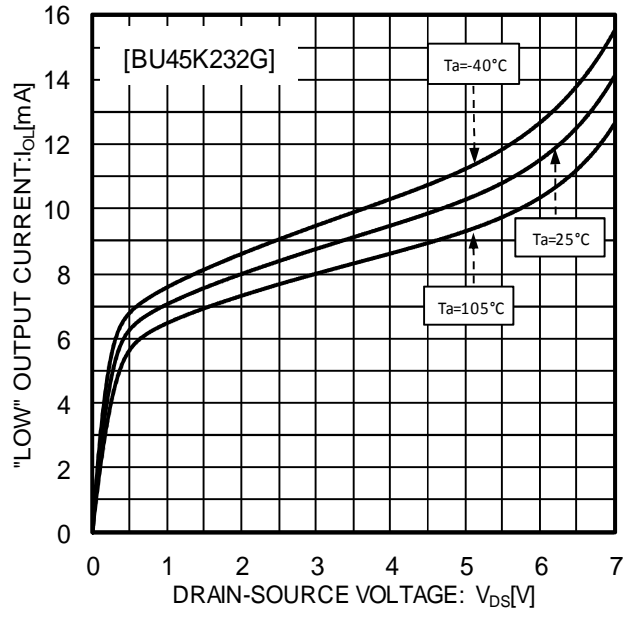

Fig.4 "LOW" Output Current  
VDD=1.2V

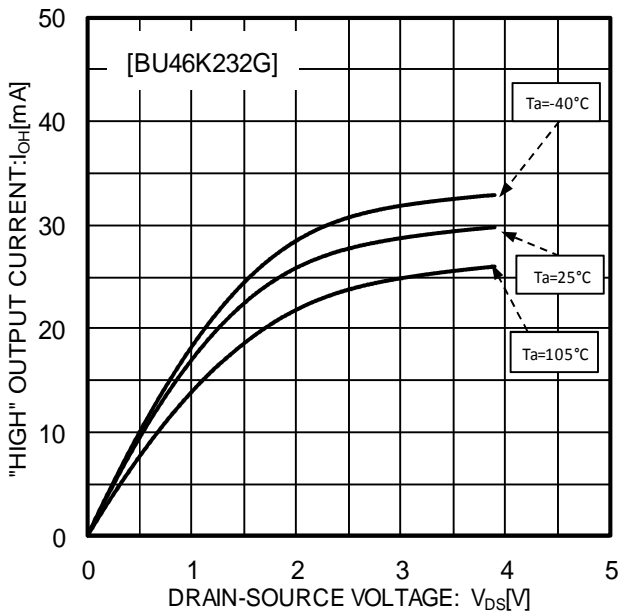

Fig.5 "HIGH" Output Current  
VDD=3.9V

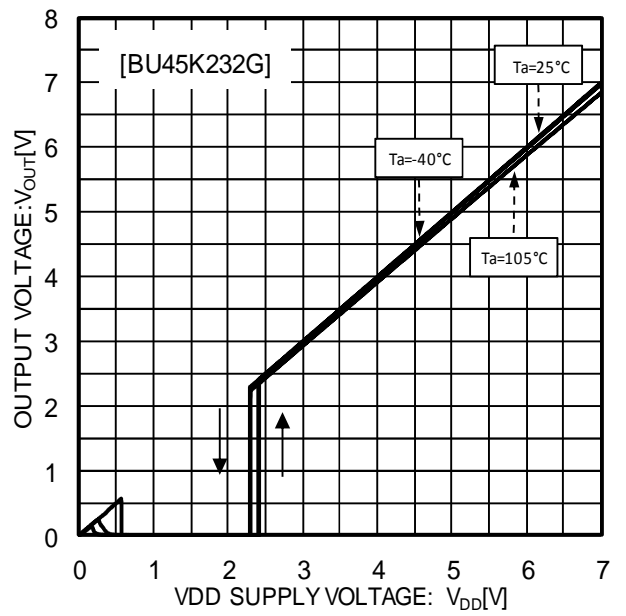

Fig.6 I/O Characteristics

● Typical Performance Curves - Continued



Fig.7 Detection Voltage Release Voltage



Fig.8 Circuit Current when ON  
( $V_{DD} = V_{DET} - 0.2V$ )  
 $V_{DD} = 2.1V$



Fig.9 Circuit Current when OFF  
( $V_{DD} = V_{DET} + 1V$ )  
 $V_{DD} = 3.3V$



Fig.10 Operating Limit Voltage

● Typical Performance Curves - Continued

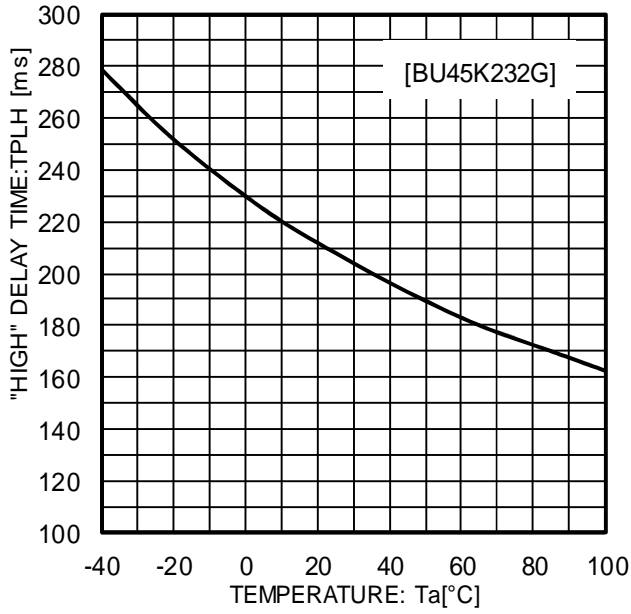

Fig.11 Output Delay Time  
"Low" → "High"

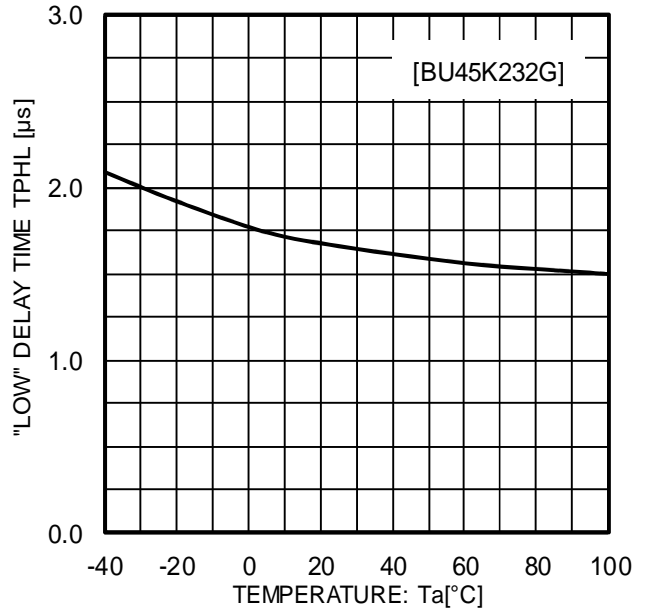

Fig.11 Output Delay Time  
"High" → "Low"



●Application Information

Explanation of Operation

For both the open drain type (Fig.13) and the CMOS output type (Fig.14), the detection and release voltages are used as threshold voltages. When the voltage applied to the V<sub>DD</sub> pins reaches the applicable threshold voltage, the V<sub>OUT</sub> terminal voltage switches from either “High” to “Low” or from “Low” to “High”. Because the BU45xxxx series uses an open drain output type, it is necessary to connect a pull-up resistor to V<sub>DD</sub> or another power supply if needed [The output “High” voltage (V<sub>OUT</sub>) in this case becomes V<sub>DD</sub> or the voltage of the other power supply].



Fig. 13 (BU45xxxx Type Internal Block Diagram)



Fig. 14 (BU46xxxx Type Internal Block Diagram)

Reference Data

Examples of Leading (t<sub>PLH</sub>) and Falling (t<sub>PHL</sub>) Output

Part Number	t <sub>PLH</sub> [ms]	t <sub>PHL</sub> [μs]
BU45K232G	208	1.4
BU46K232G	208	1.4

V<sub>DD</sub>=1.8V→2.8V                      V<sub>DD</sub>=2.8V→1.8V

\*This data is for reference only.

The figures will vary with the application, so please confirm actual operating conditions before use.

Timing Waveform

Example: The following shows the relationship between the input voltages V<sub>DD</sub> and the output voltage V<sub>OUT</sub> when the input power supply voltage V<sub>DD</sub> is made to sweep up and sweep down (the circuits are those in Fig. 13 and 14).

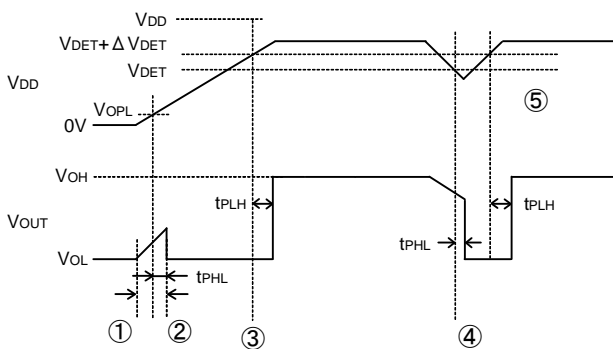

Fig.15 Timing Waveform

- ① When the power supply is turned on, the output is unstable from after over the operating limit voltage (V<sub>OPL</sub>) until t<sub>PHL</sub>. Therefore it is possible that the reset signal is not outputted when the rise time of V<sub>DD</sub> is faster than t<sub>PHL</sub>.
- ② When V<sub>DD</sub> is greater than V<sub>OPL</sub> but less than the reset release voltage (V<sub>DET</sub> + ΔV<sub>DET</sub>), the output voltages will switch to Low.
- ③ If V<sub>DD</sub> exceeds the reset release voltage (V<sub>DET</sub> + ΔV<sub>DET</sub>), the counter timer start and V<sub>OUT</sub> switches from L to H.
- ④ If V<sub>DD</sub> drops below the detection voltage (V<sub>DET</sub>) when the power supply is powered down or when there is a power supply fluctuation, V<sub>OUT</sub> switches to L (with a delay of t<sub>PHL</sub>).
- ⑤ The potential difference between the detection voltage and the release voltage is known as the hysteresis width (ΔV<sub>DET</sub>). The system is designed such that the output does not toggle with power supply fluctuations within this hysteresis width, thus, preventing malfunctions due to noise.

Timing may change depending on application and use. Please verify and confirm using practical applications.

●Circuit Applications

1. Examples of a common power supply detection reset circuit.



Fig.16 Open Drain Output Type

Application examples of BU45xxxxx series (Open Drain output type) and BU46xxxxx series (CMOS output type) are shown below.

CASE1: Power supply of microcontroller ( $V_{DD2}$ ) differs from the power supply of the reset detection ( $V_{DD1}$ ). Use an open drain output Type (BU45xxxxx series) device with a load resistance  $R_L$  as shown Fig.16.



Fig.17 CMOS Output Type

CASE2: Power supply of the microcontroller ( $V_{DD1}$ ) is same as the power supply of the reset detection ( $V_{DD1}$ ). Use a CMOS output type (BU46xxxxx) device or an open drain output type (BU45xxxxx) with pull up resistor between the output and  $V_{DD1}$ . (As shown Fig.17)

When a capacitance  $C_L$  for noise filtering is connected to the  $V_{OUT}$  pin (the reset signal input terminal of the microcontroller), please take into account the waveform of the rise and fall of the output voltage ( $V_{OUT}$ ).

2. The following is an example of a circuit application in which an OR connection between two types of detection voltage resets the microcontroller.



Fig. 18

To reset the microcontroller when many independent power supplies are used in the system, OR connect an open drain output type (BU45xxxxx series) to the microcontroller's input with pull-up resistor to the supply voltage of the microcontroller ( $V_{DD3}$ ) as shown in Fig. 18. By pulling-up to  $V_{DD3}$ , output "High" voltage of micro-controller power supply is possible.

Examples of the power supply with resistor dividers.

In applications wherein the power supply voltage of an IC comes from a resistor divider circuit, an in-rush current will flow into the circuit when the output level switches from “High” to “Low” or vice versa. In-rush current is a sudden surge of current that flows from the power supply (VDD) to ground (GND) as the output logic changes its state. This current flow may cause malfunction in the systems operation such as output oscillations, etc.

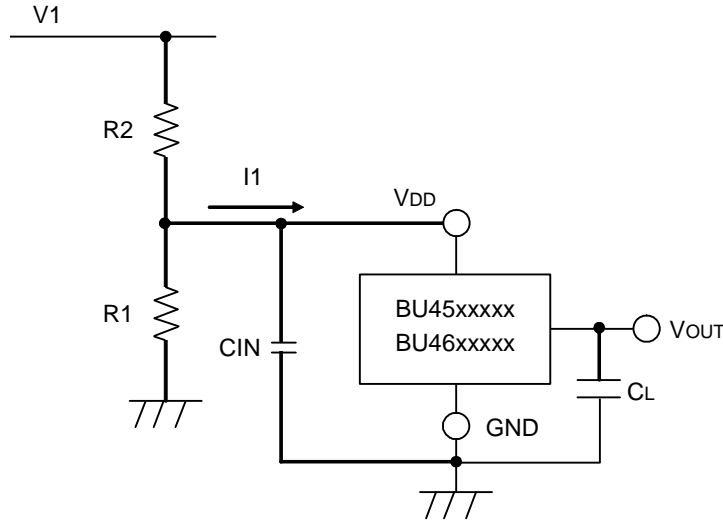

Fig. 19

When an in-rush current (I1) flows into the circuit (Refer to Fig. 19) at the time when output switches from “Low” to “High”, a voltage drop of  $I1 \times R2$  (input resistor) will occur in the circuit causing the VDD supply voltage to decrease. When the VDD voltage drops below the detection voltage, the output will switch from “High” to “Low”. While the output voltage is at “Low” condition, in-rush current will stop flowing and the voltage drop will be reduced. As a result, the output voltage will switch again from “Low” to “High” which causes an in-rush current and a voltage drop. This operation repeats and will result to oscillation.

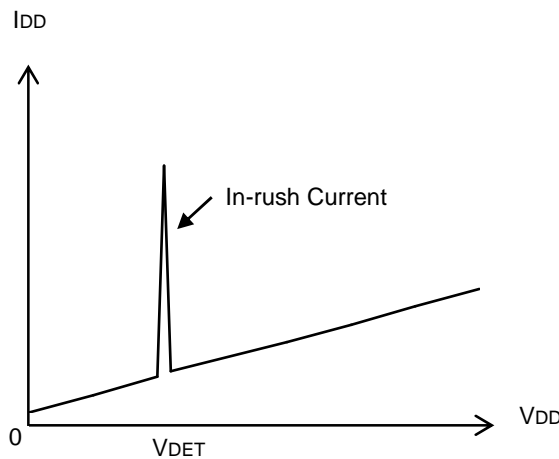

Fig. 20 Current Consumption vs. Power Supply Voltage

**●Operational Notes****1. Reverse Connection of Power Supply**

Connecting the power supply in reverse polarity can damage the IC. Take precautions against reverse polarity when connecting the power supply, such as mounting an external diode between the power supply and the IC's power supply terminals.

**2. Power Supply Lines**

Design the PCB layout pattern to provide low impedance ground and supply lines. Separate the ground and supply lines of the digital and analog blocks to prevent noise in the ground and supply lines of the digital block from affecting the analog block. Furthermore, connect a capacitor to ground at all power supply pins. Consider the effect of temperature and aging on the capacitance value when using electrolytic capacitors.

**3. Ground Voltage**

Ensure that no pins are at a voltage below that of the ground pin at any time, even during transient condition.

**4. Ground Wiring Pattern**

When using both small-signal and large-current GND traces, the two ground traces should be routed separately but connected to a single ground at the reference point of the application board to avoid fluctuations in the small-signal ground caused by large currents. Also ensure that the GND traces of external components do not cause variations on the GND voltage. The power supply and ground lines must be as short and thick as possible to reduce line impedance.

**5. Thermal Consideration**

Should by any chance the power dissipation rating be exceeded, the rise in temperature of the chip may result in deterioration of the properties of the chip. The absolute maximum rating of the Pd stated in this specification is when the IC is mounted on a 70mm x 70mm x 1.6mm glass epoxy board. In case of exceeding this absolute maximum rating, increase the board size and copper area to prevent exceeding the Pd rating.

**6. Recommended Operating Conditions**

These conditions represent a range within which the expected characteristics of the IC can be approximately obtained. The electrical characteristics are guaranteed under the conditions of each parameter.

**7. Rush Current**

When power is first supplied to the IC, it is possible that the internal logic may be unstable and inrush current may flow instantaneously due to the internal powering sequence and delays, especially if the IC has more than one power supply. Therefore, give special consideration to power coupling capacitance, power wiring, width of GND wiring, and routing of connections.

**8. Operation Under Strong Electromagnetic Field**

Operating the IC in the presence of a strong electromagnetic field may cause the IC to malfunction.

**9. Testing on Application Boards**

When testing the IC on an application board, connecting a capacitor directly to a low-impedance output pin may subject the IC to stress. Always discharge capacitors completely after each process or step. The IC's power supply should always be turned off completely before connecting or removing it from the test setup during the inspection process. To prevent damage from static discharge, ground the IC during assembly and use similar precautions during transport and storage.

**10. Inter-pin Short and Mounting Errors**

Ensure that the direction and position are correct when mounting the IC on the PCB. Incorrect mounting may result in damaging the IC. Avoid nearby pins being shorted to each other especially to ground. Inter-pin shorts could be due to many reasons such as metal particles, water droplets (in very humid environment) and unintentional solder bridge deposited in between pins during assembly to name a few.

**11. Unused Input Terminals**

Input terminals of an IC are often connected to the gate of a MOS transistor. The gate has extremely high impedance and extremely low capacitance. If left unconnected, the electric field from the outside can easily charge it. The small charge acquired in this way is enough to produce a significant effect on the conduction through the transistor and cause unexpected operation of the IC. So unless otherwise specified, unused input terminals should be connected to the power supply or ground line.

## 12. Regarding Input Pins of the IC

This monolithic IC contains P+ isolation and P substrate layers between adjacent elements in order to keep them isolated. P-N junctions are formed at the intersection of the P layers with the N layers of other elements, creating a parasitic diode or transistor. For example (refer to figure below):

When  $GND > Pin A$  and  $GND > Pin B$ , the P-N junction operates as a parasitic diode.  
When  $GND > Pin B$ , the P-N junction operates as a parasitic transistor.

Parasitic diodes inevitably occur in the structure of the IC. The operation of parasitic diodes can result in mutual interference among circuits, operational faults, or physical damage. Therefore, conditions that cause these diodes to operate, such as applying a voltage lower than the GND voltage to an input pin (and thus to the P substrate) should be avoided.



Figure 21. Example of monolithic IC structure

## 13. Ceramic Capacitor

When using a ceramic capacitor, determine the dielectric constant considering the change of capacitance with temperature and the decrease in nominal capacitance due to DC bias and others.

## 14. Bypass Capacitor for Noise Rejection

To help reject noise, put a  $1\mu\text{F}$  capacitor between VDD pin and GND and  $1000\text{pF}$  capacitor between VOUT pin and GND. Be careful when using extremely big capacitor as transient response will be affected.

15. The VDD line impedance might cause oscillation because of the detection current.

16. A VDD to GND capacitor (as close connection as possible) should be used in high VDD line impedance condition.

## 17. External Parameters

The recommended parameter range for  $R_L$  is  $50\text{k}\Omega$  to  $470\text{k}\Omega$ . There are many factors (board layout, etc) that can affect characteristics. Please verify and confirm using practical applications.

18. Lower than the minimum input voltage puts the VOUT in high impedance state, and it must be VDD in pull up (VDD) condition.

## 19. Power-on Reset Operation

Please note that the power on reset output varies with the VDD rise time. Please verify the behavior in the actual operation.

20. This IC has extremely high impedance terminals. Small leak current due to the uncleanness of PCB surface might cause unexpected operations. Application values in these conditions should be selected carefully.

Physical Dimension, Tape and Reel Information



## ●Revision History

Date	Revision	Changes
03.Feb.2014	004	New Release
03.July.2014	005	Updated Fig.5 VDD condition Updated Operational Notes and Notice

# Notice

## Precaution on using ROHM Products

- Our Products are designed and manufactured for application in ordinary electronic equipments (such as AV equipment, OA equipment, telecommunication equipment, home electronic appliances, amusement equipment, etc.). If you intend to use our Products in devices requiring extremely high reliability (such as medical equipment <sup>(Note 1)</sup>, transport equipment, traffic equipment, aircraft/spacecraft, nuclear power controllers, fuel controllers, car equipment including car accessories, safety devices, etc.) and whose malfunction or failure may cause loss of human life, bodily injury or serious damage to property ("Specific Applications"), please consult with the ROHM sales representative in advance. Unless otherwise agreed in writing by ROHM in advance, ROHM shall not be in any way responsible or liable for any damages, expenses or losses incurred by you or third parties arising from the use of any ROHM's Products for Specific Applications.

(Note1) Medical Equipment Classification of the Specific Applications

JAPAN	USA	EU	CHINA
CLASS III	CLASS III	CLASS II b	CLASS III
CLASS IV		CLASS III	

- ROHM designs and manufactures its Products subject to strict quality control system. However, semiconductor products can fail or malfunction at a certain rate. Please be sure to implement, at your own responsibilities, adequate safety measures including but not limited to fail-safe design against the physical injury, damage to any property, which a failure or malfunction of our Products may cause. The following are examples of safety measures:
  - Installation of protection circuits or other protective devices to improve system safety
  - Installation of redundant circuits to reduce the impact of single or multiple circuit failure
- Our Products are designed and manufactured for use under standard conditions and not under any special or extraordinary environments or conditions, as exemplified below. Accordingly, ROHM shall not be in any way responsible or liable for any damages, expenses or losses arising from the use of any ROHM's Products under any special or extraordinary environments or conditions. If you intend to use our Products under any special or extraordinary environments or conditions (as exemplified below), your independent verification and confirmation of product performance, reliability, etc. prior to use, must be necessary:
  - Use of our Products in any types of liquid, including water, oils, chemicals, and organic solvents
  - Use of our Products outdoors or in places where the Products are exposed to direct sunlight or dust
  - Use of our Products in places where the Products are exposed to sea wind or corrosive gases, including Cl<sub>2</sub>, H<sub>2</sub>S, NH<sub>3</sub>, SO<sub>2</sub>, and NO<sub>2</sub>
  - Use of our Products in places where the Products are exposed to static electricity or electromagnetic waves
  - Use of our Products in proximity to heat-producing components, plastic cords, or other flammable items
  - Sealing or coating our Products with resin or other coating materials
  - Use of our Products without cleaning residue of flux (even if you use no-clean type fluxes, cleaning residue of flux is recommended); or Washing our Products by using water or water-soluble cleaning agents for cleaning residue after soldering
  - Use of the Products in places subject to dew condensation
- The Products are not subject to radiation-proof design.
- Please verify and confirm characteristics of the final or mounted products in using the Products.
- In particular, if a transient load (a large amount of load applied in a short period of time, such as pulse. is applied, confirmation of performance characteristics after on-board mounting is strongly recommended. Avoid applying power exceeding normal rated power; exceeding the power rating under steady-state loading condition may negatively affect product performance and reliability.
- De-rate Power Dissipation (Pd) depending on Ambient temperature (Ta). When used in sealed area, confirm the actual ambient temperature.
- Confirm that operation temperature is within the specified range described in the product specification.
- ROHM shall not be in any way responsible or liable for failure induced under deviant condition from what is defined in this document.

## Precaution for Mounting / Circuit board design

- When a highly active halogenous (chlorine, bromine, etc.) flux is used, the residue of flux may negatively affect product performance and reliability.
- In principle, the reflow soldering method must be used; if flow soldering method is preferred, please consult with the ROHM representative in advance.

For details, please refer to ROHM Mounting specification



**Precautions Regarding Application Examples and External Circuits**

1. If change is made to the constant of an external circuit, please allow a sufficient margin considering variations of the characteristics of the Products and external components, including transient characteristics, as well as static characteristics.
2. You agree that application notes, reference designs, and associated data and information contained in this document are presented only as guidance for Products use. Therefore, in case you use such information, you are solely responsible for it and you must exercise your own independent verification and judgment in the use of such information contained in this document. ROHM shall not be in any way responsible or liable for any damages, expenses or losses incurred by you or third parties arising from the use of such information.

**Precaution for Electrostatic**

This Product is electrostatic sensitive product, which may be damaged due to electrostatic discharge. Please take proper caution in your manufacturing process and storage so that voltage exceeding the Products maximum rating will not be applied to Products. Please take special care under dry condition (e.g. Grounding of human body / equipment / solder iron, isolation from charged objects, setting of Ionizer, friction prevention and temperature / humidity control).

**Precaution for Storage / Transportation**

1. Product performance and soldered connections may deteriorate if the Products are stored in the places where:
  - [a] the Products are exposed to sea winds or corrosive gases, including Cl<sub>2</sub>, H<sub>2</sub>S, NH<sub>3</sub>, SO<sub>2</sub>, and NO<sub>2</sub>
  - [b] the temperature or humidity exceeds those recommended by ROHM
  - [c] the Products are exposed to direct sunshine or condensation
  - [d] the Products are exposed to high Electrostatic
2. Even under ROHM recommended storage condition, solderability of products out of recommended storage time period may be degraded. It is strongly recommended to confirm solderability before using Products of which storage time is exceeding the recommended storage time period.
3. Store / transport cartons in the correct direction, which is indicated on a carton with a symbol. Otherwise bent leads may occur due to excessive stress applied when dropping of a carton.
4. Use Products within the specified time after opening a humidity barrier bag. Baking is required before using Products of which storage time is exceeding the recommended storage time period.

**Precaution for Product Label**

QR code printed on ROHM Products label is for ROHM's internal use only.

**Precaution for Disposition**

When disposing Products please dispose them properly using an authorized industry waste company.

**Precaution for Foreign Exchange and Foreign Trade act**

Since our Products might fall under controlled goods prescribed by the applicable foreign exchange and foreign trade act, please consult with ROHM representative in case of export.

**Precaution Regarding Intellectual Property Rights**

1. All information and data including but not limited to application example contained in this document is for reference only. ROHM does not warrant that foregoing information or data will not infringe any intellectual property rights or any other rights of any third party regarding such information or data. ROHM shall not be in any way responsible or liable for infringement of any intellectual property rights or other damages arising from use of such information or data.:
2. No license, expressly or implied, is granted hereby under any intellectual property rights or other rights of ROHM or any third parties with respect to the information contained in this document.

**Other Precaution**

1. This document may not be reprinted or reproduced, in whole or in part, without prior written consent of ROHM.
2. The Products may not be disassembled, converted, modified, reproduced or otherwise changed without prior written consent of ROHM.
3. In no event shall you use in any way whatsoever the Products and the related technical information contained in the Products or this document for any military purposes, including but not limited to, the development of mass-destruction weapons.
4. The proper names of companies or products described in this document are trademarks or registered trademarks of ROHM, its affiliated companies or third parties.

**General Precaution**

1. Before you use our Products, you are requested to carefully read this document and fully understand its contents. ROHM shall not be in any way responsible or liable for failure, malfunction or accident arising from the use of any ROHM's Products against warning, caution or note contained in this document.
2. All information contained in this document is current as of the issuing date and subject to change without any prior notice. Before purchasing or using ROHM's Products, please confirm the latest information with a ROHM sales representative.
3. The information contained in this document is provided on an "as is" basis and ROHM does not warrant that all information contained in this document is accurate and/or error-free. ROHM shall not be in any way responsible or liable for any damages, expenses or losses incurred by you or third parties resulting from inaccuracy or errors of or concerning such information.



Компания «ЭлектроПласт» предлагает заключение долгосрочных отношений при поставках импортных электронных компонентов на взаимовыгодных условиях!

Наши преимущества:

- Оперативные поставки широкого спектра электронных компонентов отечественного и импортного производства напрямую от производителей и с крупнейших мировых складов;
- Поставка более 17-ти миллионов наименований электронных компонентов;
- Поставка сложных, дефицитных, либо снятых с производства позиций;
- Оперативные сроки поставки под заказ (от 5 рабочих дней);
- Экспресс доставка в любую точку России;
- Техническая поддержка проекта, помощь в подборе аналогов, поставка прототипов;
- Система менеджмента качества сертифицирована по Международному стандарту ISO 9001;
- Лицензия ФСБ на осуществление работ с использованием сведений, составляющих государственную тайну;
- Поставка специализированных компонентов (Xilinx, Altera, Analog Devices, Intersil, Interpoint, Microsemi, Aeroflex, Peregrine, Syfer, Eurofarad, Texas Instrument, Miteq, Cobham, E2V, MA-COM, Hittite, Mini-Circuits, General Dynamics и др.);

Помимо этого, одним из направлений компании «ЭлектроПласт» является направление «Источники питания». Мы предлагаем Вам помощь Конструкторского отдела:

- Подбор оптимального решения, техническое обоснование при выборе компонента;
- Подбор аналогов;
- Консультации по применению компонента;
- Поставка образцов и прототипов;
- Техническая поддержка проекта;
- Защита от снятия компонента с производства.



#### Как с нами связаться

**Телефон:** 8 (812) 309 58 32 (многоканальный)

**Факс:** 8 (812) 320-02-42

**Электронная почта:** [org@eplast1.ru](mailto:org@eplast1.ru)

**Адрес:** 198099, г. Санкт-Петербург, ул. Калинина, дом 2, корпус 4, литера А.