

### FEATURES

#### Excellent ac performance

- 3 dB bandwidth
- 800 MHz (200 mV p-p)
- 750 MHz (2 V p-p)
- Slew rate: 2400 V/ $\mu$ s

#### Low power: 75 mW, $V_S = \pm 5$ V

#### Excellent video performance

- 100 MHz, 0.1 dB gain flatness
- 0.02% differential gain error/0.02° differential phase error  
( $R_L = 150 \Omega$ )

ADV3221 is a pin-for-pin upgrade to the HA4344

Gain = +1 (ADV3221) or gain = +2 (ADV3222)

Low all hostile crosstalk of -85 dB @ 5 MHz, and

- 58 dB @ 100 MHz

Latched control lines for synchronous switching

High impedance output disable allows connection of multiple devices without loading the output bus

16-lead SOIC

### APPLICATIONS

#### Routing of high speed signals including

- Video (NTSC, PAL, S, SECAM, YUV, RGB)
- Compressed video (MPEG, wavelet)
- 3-level digital video (HDB3)

#### Data communications

#### Telecommunications

### GENERAL DESCRIPTION

The ADV3221 and ADV3222 are high speed, high slew rate, buffered 4:1 analog multiplexers. They offer a -3 dB signal bandwidth greater than 800 MHz and channel switch times of less than 20 ns with 1% settling. With lower than -58 dB of crosstalk and -67 dB isolation (at 100 MHz), the ADV3221 and ADV3222 are useful in many high speed applications. The differential gain error of less than 0.02% and differential phase error of less than 0.02°, together with 0.1 dB gain flatness out to 100 MHz while driving a 75  $\Omega$  back terminated load, make the ADV3221 and ADV3222 ideal for all types of signal switching.

The ADV3221/ADV3222 include an output buffer that can be placed into a high impedance state. This allows multiple outputs

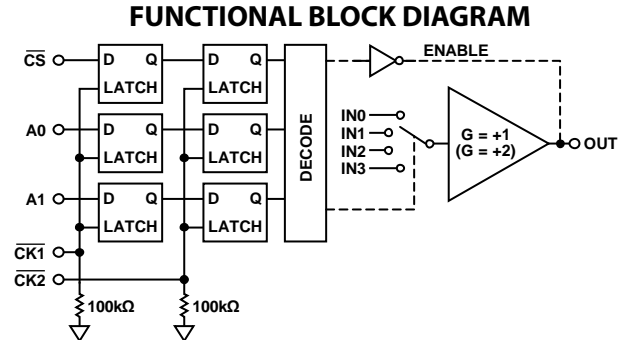

Figure 1.

to be connected together for cascading stages without the off channels loading the output bus. The ADV3221 has a gain of +1, and the ADV3222 has a gain of +2; they both operate on  $\pm 5$  V supplies while consuming less than 7.5 mA of idle current. The channel switching is performed via latched control lines, allowing synchronous updating in a multiple ADV3221/ADV3222 environment.

The ADV3221/ADV3222 are offered in a 16-lead SOIC package and are available over the extended industrial temperature range of -40°C to +85°C.

#### Rev. 0

Information furnished by Analog Devices is believed to be accurate and reliable. However, no responsibility is assumed by Analog Devices for its use, nor for any infringements of patents or other rights of third parties that may result from its use. Specifications subject to change without notice. No license is granted by implication or otherwise under any patent or patent rights of Analog Devices. Trademarks and registered trademarks are the property of their respective owners.

**TABLE OF CONTENTS**

Features .....	1	Typical Performance Characteristics .....	8
Applications.....	1	Circuit Diagrams .....	16
Functional Block Diagram .....	1	Theory of Operation .....	17
General Description .....	1	Applications Information .....	18
Revision History .....	2	CK1/CK2 Operation .....	18
Specifications.....	3	Circuit Layout .....	18
Timing and Logic Characteristics.....	4	Termination.....	18
Absolute Maximum Ratings.....	6	Capacitive Load .....	18
Thermal Resistance .....	6	Outline Dimensions .....	19
Power Dissipation.....	6	Ordering Guide .....	19
ESD Caution.....	6		
Pin Configuration and Function Descriptions.....	7		

**REVISION HISTORY**

**3/10—Revision 0: Initial Version**

## SPECIFICATIONS

$V_S = \pm 5\text{ V}$ ,  $T_A = 25^\circ\text{C}$ ,  $R_L = 150\ \Omega$ ,  $C_L = 2\ \text{pF}$ , ADV3221 at  $G = +1$ , ADV3222 at  $G = +2$ , unless otherwise noted.

**Table 1.**

Parameter	Test Conditions/Comments	ADV3221			ADV3222			Unit
		Min	Typ	Max	Min	Typ	Max	
<b>DYNAMIC PERFORMANCE</b>								
–3 dB Bandwidth	200 mV p-p		1000		800			MHz
	2 V p-p		750		750			MHz
Gain Flatness	0.1 dB, 200 mV p-p		100		100			MHz
	0.1 dB, 2 V p-p		100		100			MHz
Propagation Delay	2 V p-p		700		650			ps
Settling Time	1%, 2 V step		5		5			ns
Slew Rate	2 V step, peak		2400		2700			V/ $\mu\text{s}$
<b>NOISE/DISTORTION PERFORMANCE</b>								
Differential Gain Error	NTSC or PAL		0.01		0.02			%
Differential Phase Error	NTSC or PAL		0.01		0.02			Degrees
Crosstalk, All Hostile	$f = 100\ \text{MHz}$		–87		–58			dB
	$f = 5\ \text{MHz}$		–100		–85			dB
Off Isolation, Input to Output	$f = 100\ \text{MHz}$ , one channel		–67		–72			dB
Input Second-Order Intercept (ADV3222 Only)	$f = 70\ \text{MHz}$ , $R_L = 100\ \Omega$				54			dBm
Input Third-Order Intercept (ADV3222 Only)	$f = 70\ \text{MHz}$ , $R_L = 100\ \Omega$				17			dBm
Output 1 dB Compression Point (ADV3222 Only)	$f = 70\ \text{MHz}$ , $R_L = 100\ \Omega$				18.5			dBm
Input Voltage Noise	10 MHz to 100 MHz		16		17			nV/ $\sqrt{\text{Hz}}$
<b>DC PERFORMANCE</b>								
Gain Error	No load			1			1	%
	$R_L = 150\ \Omega$		0.75		0.75			%
Gain Matching	Channel-to-channel, no load		1		1			%
<b>OUTPUT CHARACTERISTICS</b>								
Output Impedance	DC, enabled		0.02		0.04			$\Omega$
	Disabled	1			1			M $\Omega$
Output Disable Capacitance	Disabled		2.8		3			pF
Output Leakage Current	Disabled		2		2			$\mu\text{A}$
Output Voltage Range	No load	$\pm 2.9$	$\pm 3$		$\pm 2.9$	$\pm 3$		V
	$R_L = 150\ \Omega$	$\pm 2.8$	$\pm 3$		$\pm 2.75$	$\pm 3$		V
Short-Circuit Current			50		50			mA
<b>INPUT CHARACTERISTICS</b>								
Input Offset Voltage	Worst case (all configurations)		$\pm 5$	$\pm 21$		$\pm 5$	$\pm 21$	mV
Input Offset Voltage Drift			$\pm 10$		$\pm 10$			$\mu\text{V}/^\circ\text{C}$
Input Voltage Range			$\pm 3$		$\pm 1.5$			V
Input Capacitance	Any switch configuration		1.8		1.8			pF
Input Resistance	Output enabled	1	10		1	10		M $\Omega$
Input Bias Current	Output enabled		5	12		6	12	$\mu\text{A}$
<b>SWITCHING CHARACTERISTICS</b>								
Enable On Time			15		15			ns
Switching Time, 2 V Step	50% A0 to 1% settling		20		20			ns
Switching Transient (Glitch)	IN0 to IN1 switching		28		55			mV p-p

# ADV3221/ADV3222

Parameter	Test Conditions/Comments	ADV3221			ADV3222			Unit
		Min	Typ	Max	Min	Typ	Max	
POWER SUPPLIES								
Supply Current	V+, output enabled, no load	7	8		7.5	9		mA
	V+, output disabled ( $\overline{CS}$ high)	1.6	2.0		1.8	2.2		mA
	V-, output enabled, no load	7	8		7.5	9		mA
	V-, output disabled ( $\overline{CS}$ high)	1.6	2.0		1.8	2.2		mA
Supply Voltage Range		±4.5		±5.5	±4.5		±5.5	V
Power Supply Rejection (PSR)	f = 100 kHz		-70			-65		dB
	f = 1 MHz		-60			-55		dB
TEMPERATURE								
Operating Temperature Range	Still air	-40		+85	-40		+85	°C
Junction-to-Ambient Thermal Impedance ( $\theta_{JA}$ )	Operating (still air)		81			81		°C/W

## TIMING AND LOGIC CHARACTERISTICS

Table 2.

Parameter	Symbol	Min	Typ	Max	Unit
A0, A1, $\overline{CS}$ Setup Time	$t_1$	20			ns
$\overline{CK1}$ Pulse Width	$t_2$	40			ns
$\overline{CK1}$ to $\overline{CK2}$ Pulse Separation	$t_3$	40			ns
$\overline{CK2}$ Pulse Width	$t_4$	40			ns
A0, A1, $\overline{CS}$ Hold Time	$t_5$	20			ns

Table 3. Logic Levels

$V_{IH}$	$V_{IL}$	$I_{IH}$	$I_{IL}$	$I_{IH}$	$I_{IL}$
A0, A1, $\overline{CK1}$ , $\overline{CK2}$ , $\overline{CS}$	A0, A1, $\overline{CK1}$ , $\overline{CK2}$ , $\overline{CS}$	A0, A1, $\overline{CS}$	A0, A1, $\overline{CS}$	$\overline{CK1}$ , $\overline{CK2}$	$\overline{CK1}$ , $\overline{CK2}$
+2.0 V min	+0.8 V max	±2 $\mu$ A max	±2 $\mu$ A max	+60 $\mu$ A max	+10 $\mu$ A max

Timing and Programming Diagrams

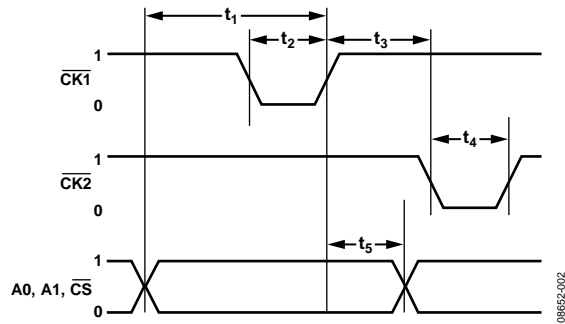

Figure 2. Timing Diagram

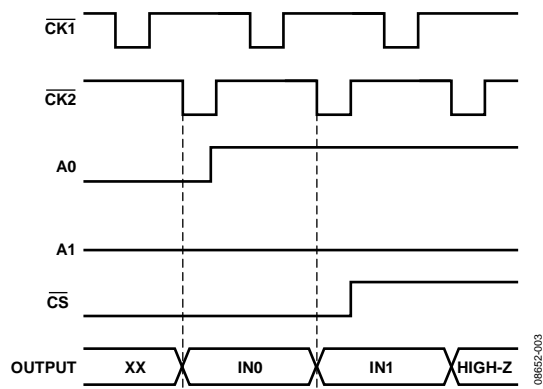

Figure 3. Programming Example

## ABSOLUTE MAXIMUM RATINGS

Table 4.

Parameter	Rating
Supply Voltage (V+ – V–)	12 V
Analog Input Voltage	V– to V+
Digital Input Voltage	0 V to V+
Output Voltage (Disabled Output)	(V+ – 1 V) to (V– + 1 V)
Output Short-Circuit Duration	Momentary
Output Short-Circuit Current	50 mA
Storage Temperature Range	–65°C to +150°C
Operating Temperature Range	–40°C to +85°C
Lead Temperature (Soldering, 10 sec)	300°C
Junction Temperature	150°C

Stresses above those listed under Absolute Maximum Ratings may cause permanent damage to the device. This is a stress rating only; functional operation of the device at these or any other conditions above those indicated in the operational section of this specification is not implied. Exposure to absolute maximum rating conditions for extended periods may affect device reliability.

### THERMAL RESISTANCE

$\theta_{JA}$  is specified for the worst-case conditions, that is, a device soldered in a circuit board for surface-mount packages.

Table 5. Thermal Resistance

Package Type	$\theta_{JA}$	$\theta_{JC}$	Unit
16-Lead Narrow-Body SOIC	81	43	°C/W

### POWER DISSIPATION

The ADV3221/ADV3222 are operated with  $\pm 5$  V supplies and can drive loads down to 150  $\Omega$ , resulting in a wide range of possible power dissipations. For this reason, extra care must be taken to adjust the operating conditions based on ambient temperature.

Packaged in a 16-lead narrow-body SOIC, the ADV3221 and ADV3222 junction-to-ambient thermal impedance ( $\theta_{JA}$ ) is 81°C/W. For long-term reliability, the maximum allowed junction temperature of the die,  $T_J$ , should not exceed 125°C. Temporarily exceeding this limit may cause a shift in parametric performance due to a change in stresses exerted on the die by the package. Figure 4 shows the range of the allowed internal die power dissipations that meet these conditions over the –40°C to +85°C ambient temperature range. When using Figure 4, do not include the external load power in the maximum power calculation, but do include the load current through the die output transistors.

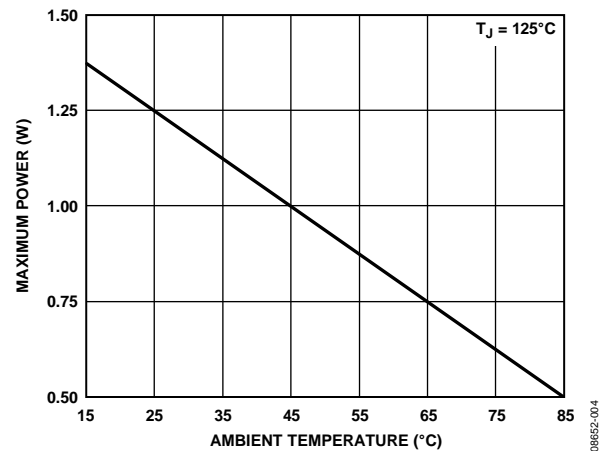

Figure 4. Maximum Die Power Dissipation vs. Ambient Temperature

### ESD CAUTION



**ESD (electrostatic discharge) sensitive device.** Charged devices and circuit boards can discharge without detection. Although this product features patented or proprietary protection circuitry, damage may occur on devices subjected to high energy ESD. Therefore, proper ESD precautions should be taken to avoid performance degradation or loss of functionality.

## PIN CONFIGURATION AND FUNCTION DESCRIPTIONS

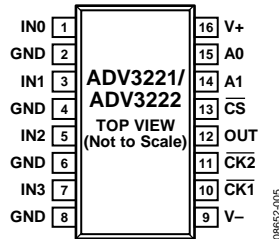

Figure 5. Pin Configuration

Table 6. Pin Function Descriptions

Pin No.	Mnemonic	Description
1	IN0	Analog Input
2	GND	Ground
3	IN1	Analog Input
4	GND	Ground
5	IN2	Analog Input
6	GND	Ground
7	IN3	Analog Input
8	GND	Ground
9	V <sub>-</sub>	Negative Power Supply
10	$\overline{\text{CK1}}$	First Rank Clock
11	$\overline{\text{CK2}}$	Second Rank Clock
12	OUT	Analog Output
13	$\overline{\text{CS}}$	Chip Select (Output Enable)
14	A1	Select Address Most Significant Bit
15	A0	Select Address Least Significant Bit
16	V <sub>+</sub>	Positive Power Supply

Table 7. Truth Table

CS	A1	A0	CK1	CK2	Output
0	0	0	0	0	IN0
0	0	1	0	0	IN1
0	1	0	0	0	IN2
0	1	1	0	0	IN3
1	X <sup>1</sup>	X <sup>1</sup>	0	0	High-Z

<sup>1</sup> X is don't care.

## TYPICAL PERFORMANCE CHARACTERISTICS

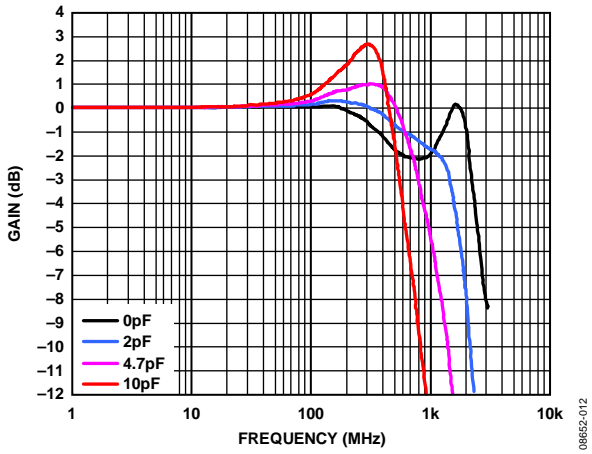

Figure 6. ADV3221 Small Signal Response vs. Capacitive Load, 200 mV p-p

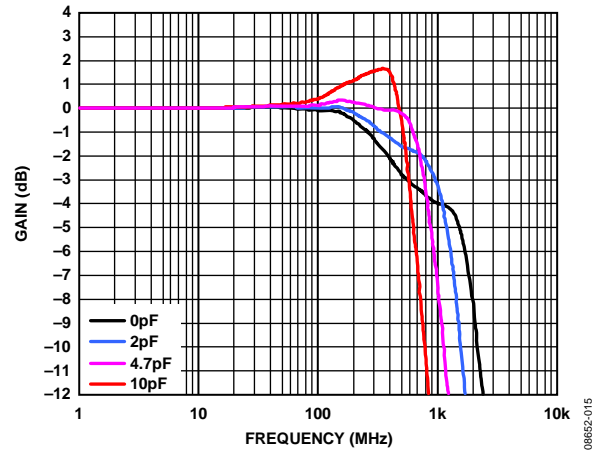

Figure 9. ADV3222 Small Signal Response vs. Capacitive Load, 200 mV p-p

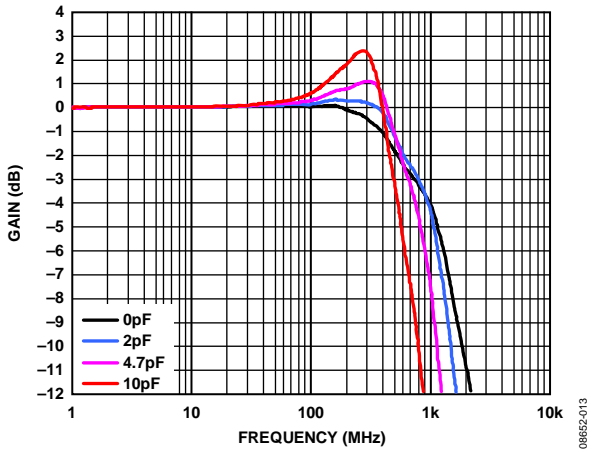

Figure 7. ADV3221 Large Signal Response vs. Capacitive Load, 2 V p-p

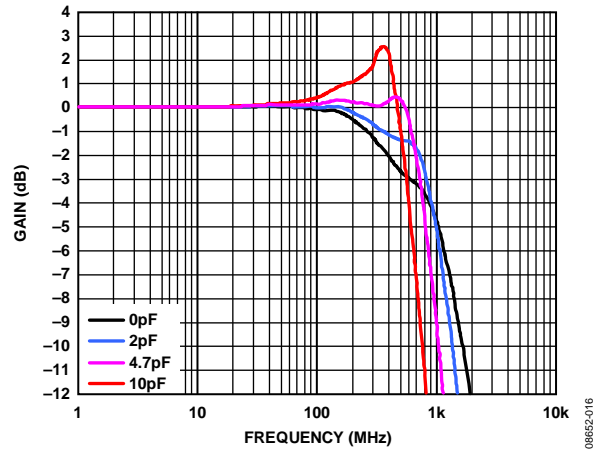

Figure 10. ADV3222 Large Signal Response vs. Capacitive Load, 2 V p-p

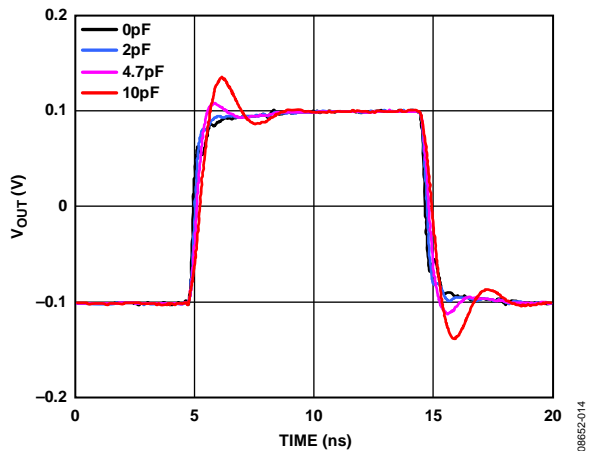

Figure 8. ADV3221 Small Signal Pulse Response vs. Capacitive Load, 200 mV p-p

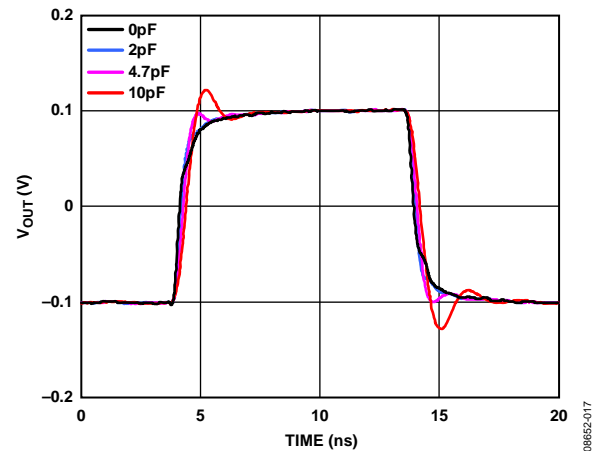

Figure 11. ADV3222 Small Signal Pulse Response vs. Capacitive Load, 200 mV p-p



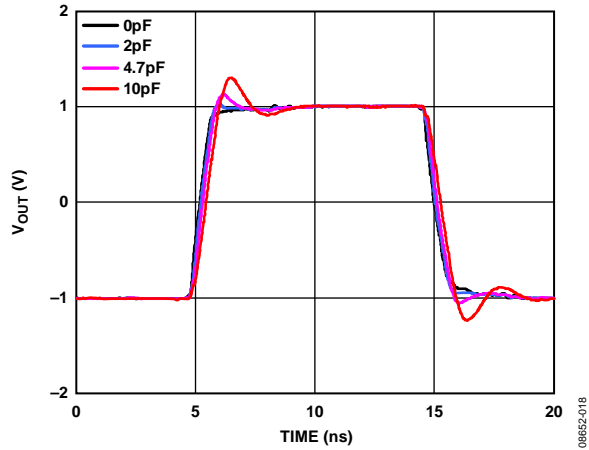

Figure 12. ADV3221 Large Signal Pulse Response vs. Capacitive Load, 2 V p-p

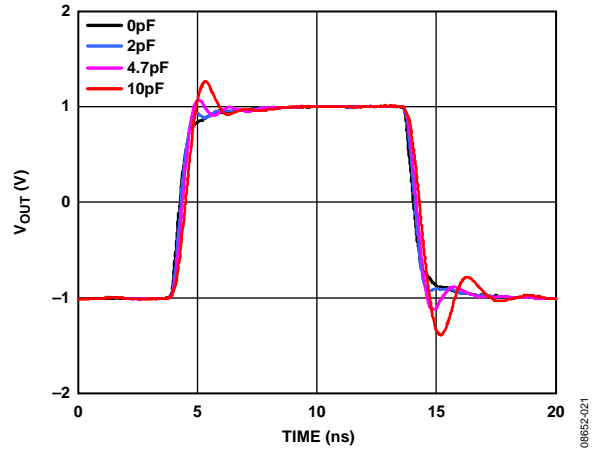

Figure 15. ADV3222 Large Signal Pulse Response vs. Capacitive Load, 2 V p-p

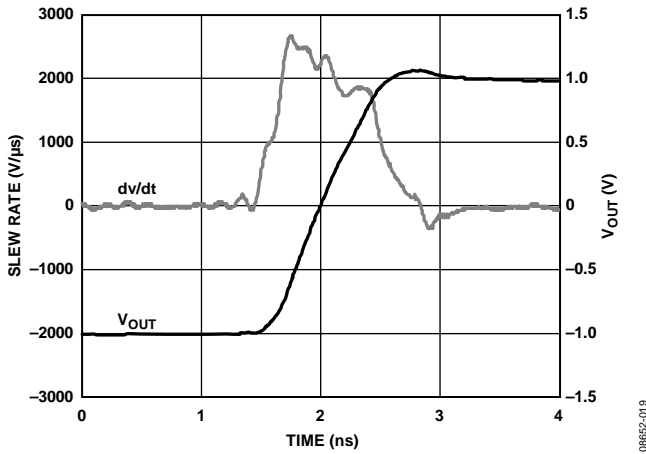

Figure 13. ADV3221 Large Signal Rising Slew Rate with 3 pF Load, 2 V p-p

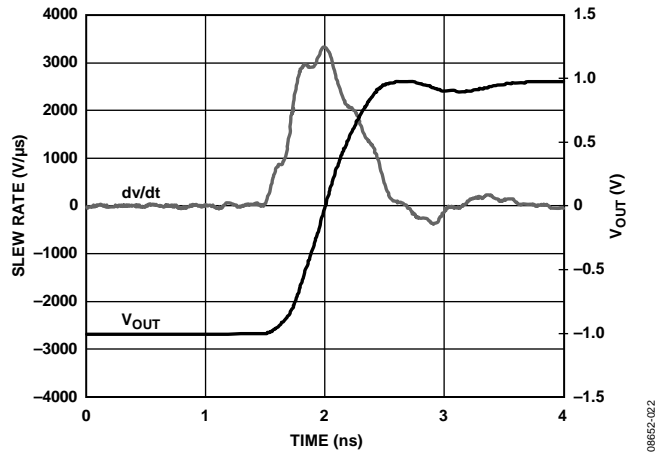

Figure 16. ADV3222 Large Signal Rising Slew Rate with 3 pF Load, 2 V p-p

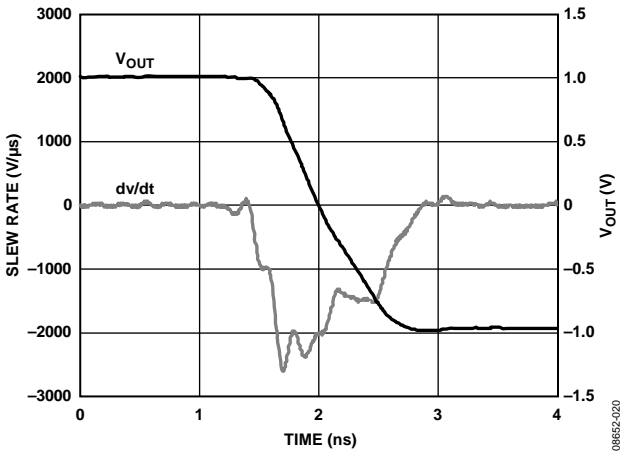

Figure 14. ADV3221 Large Signal Falling Slew Rate with 3 pF Load, 2 V p-p

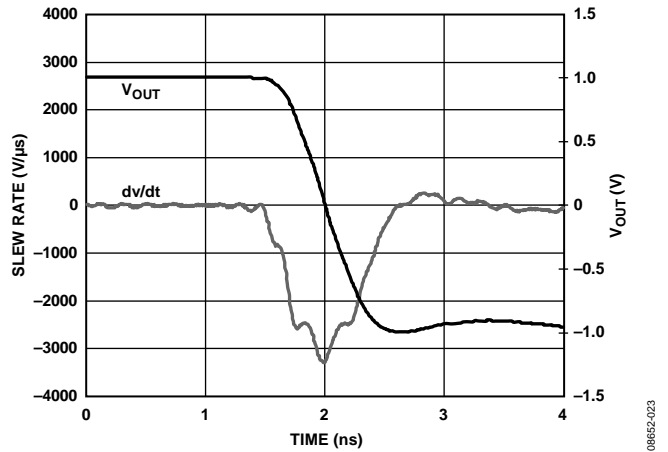

Figure 17. ADV3222 Large Signal Falling Slew Rate with 3 pF Load, 2 V p-p

# ADV3221/ADV3222

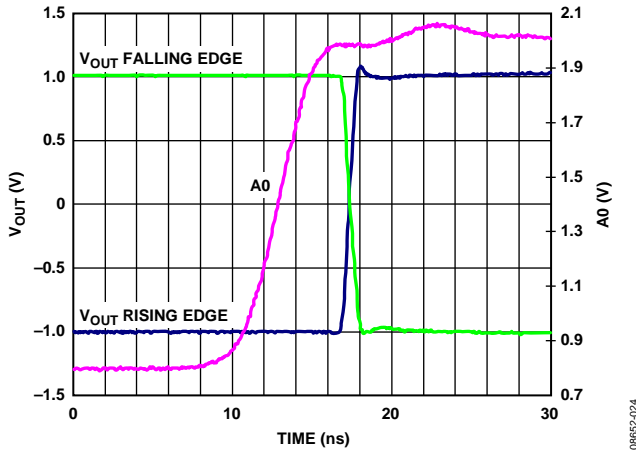

Figure 18. ADV3221 Switching Time

08852-024

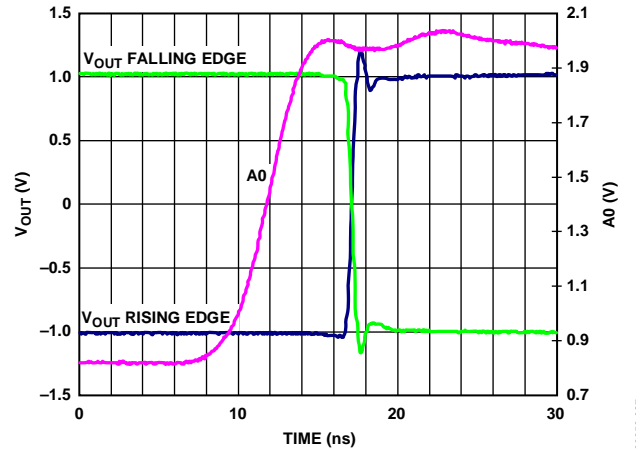

Figure 21. ADV3222 Switching Time

08852-027

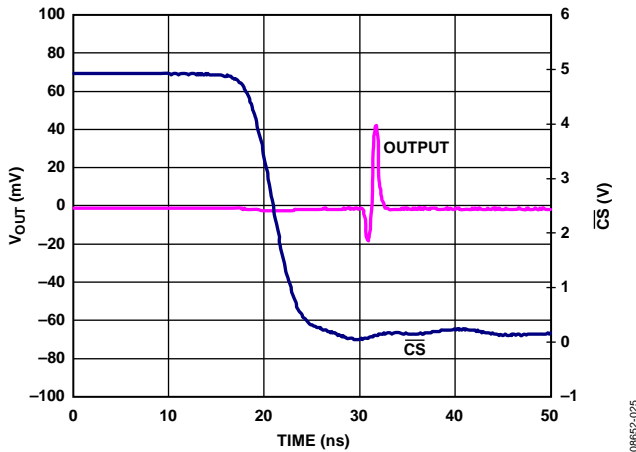

Figure 19. ADV3221 Enable Glitch

08852-025

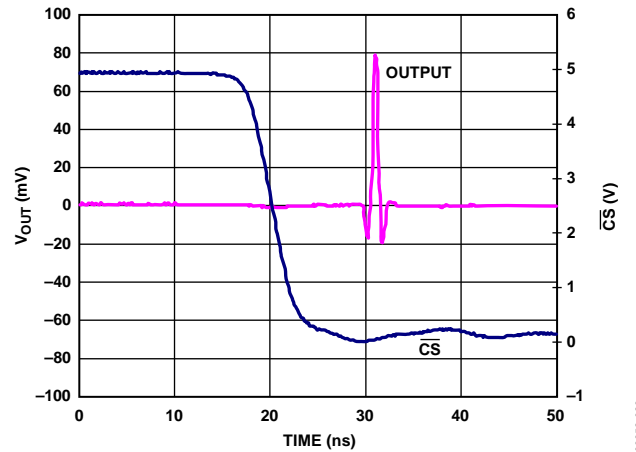

Figure 22. ADV3222 Enable Glitch

08852-028

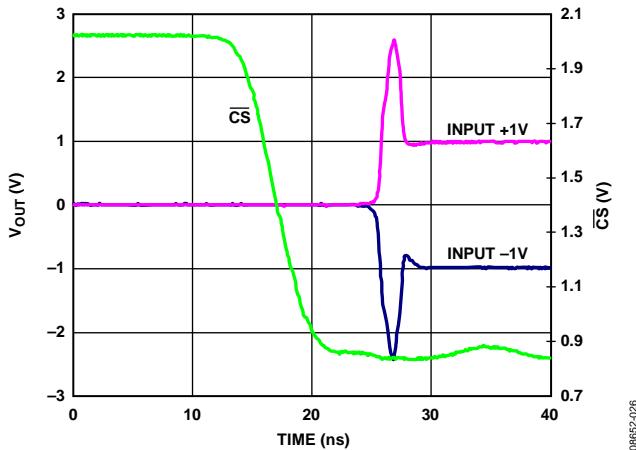

Figure 20. ADV3221 Enable On Timing

08852-026

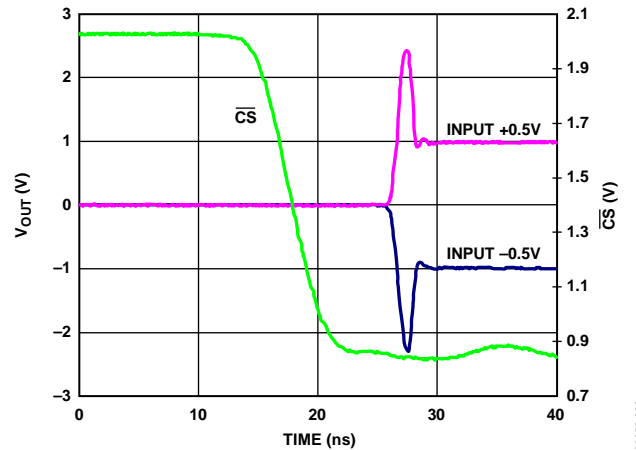

Figure 23. ADV3222 Enable On Timing

08852-029

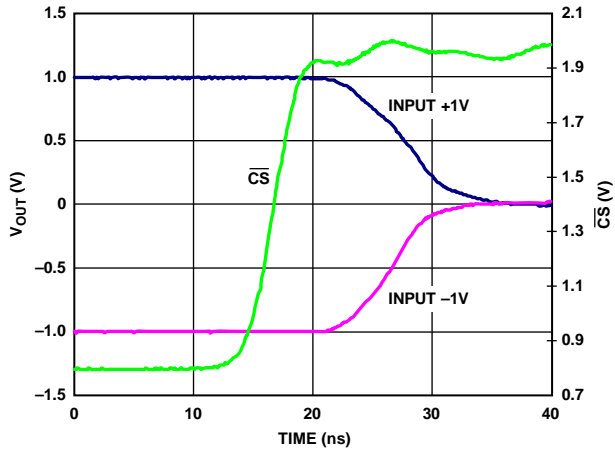

Figure 24. ADV3221 Disable Timing

08652-030

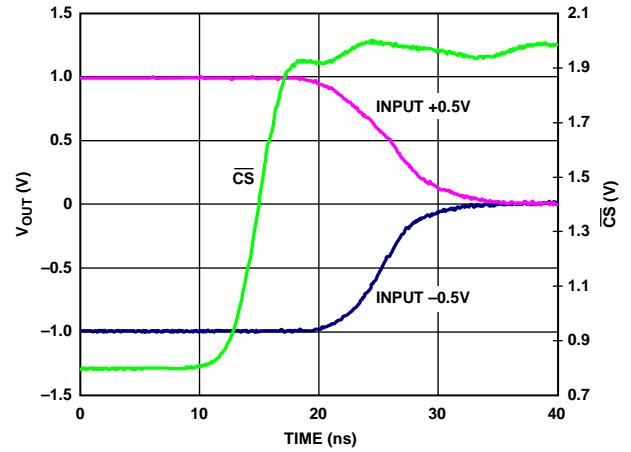

Figure 27. ADV3222 Disable Timing

08652-033

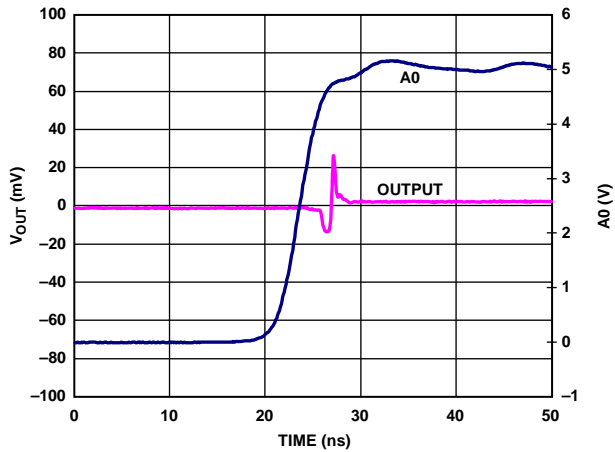

Figure 25. ADV3221 Switching Glitch Rising Edge

08652-031

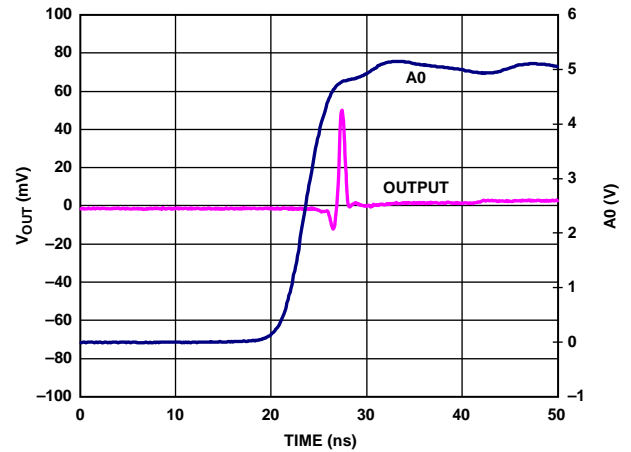

Figure 28. ADV3222 Switching Glitch Rising Edge

08652-034

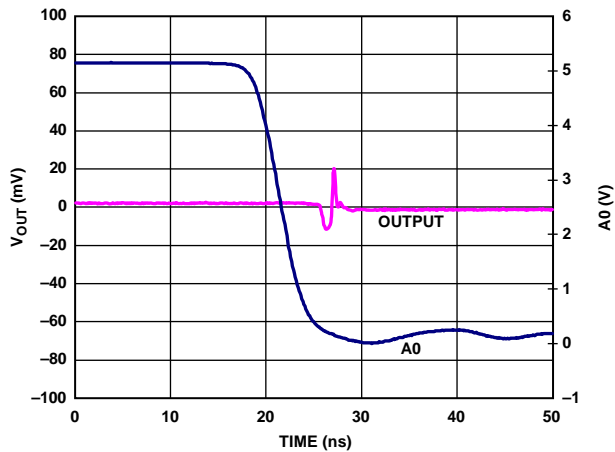

Figure 26. ADV3221 Switching Glitch Falling Edge

08652-032

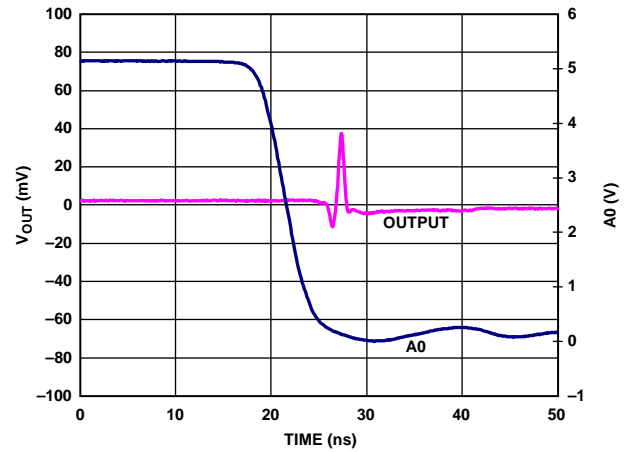

Figure 29. ADV3222 Switching Glitch Falling Edge

08652-035

# ADV3221/ADV3222

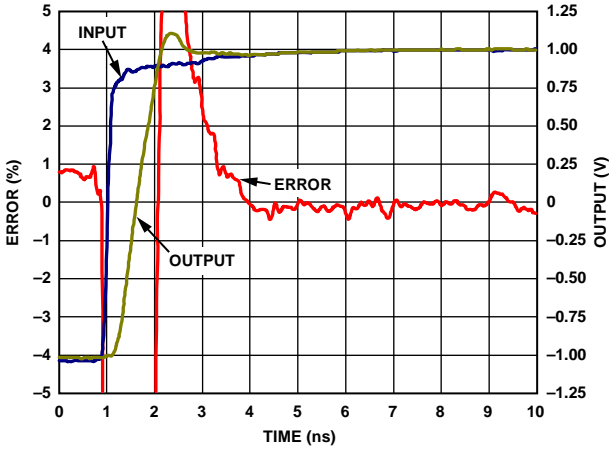

Figure 30. ADV3221 Settling Time, 2 V Step

08652-036

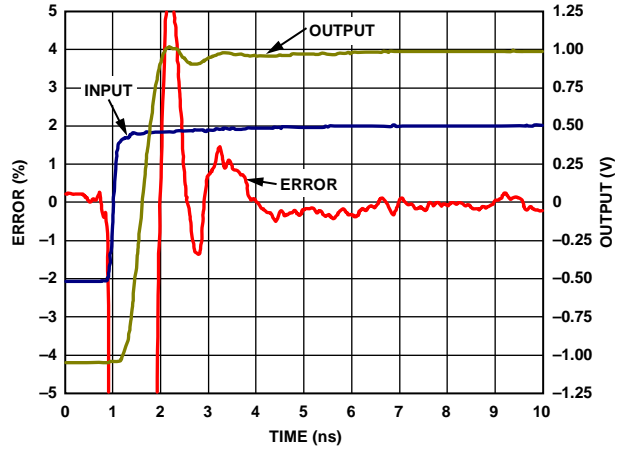

Figure 33. ADV3222 Settling Time, 2 V Step

08652-039

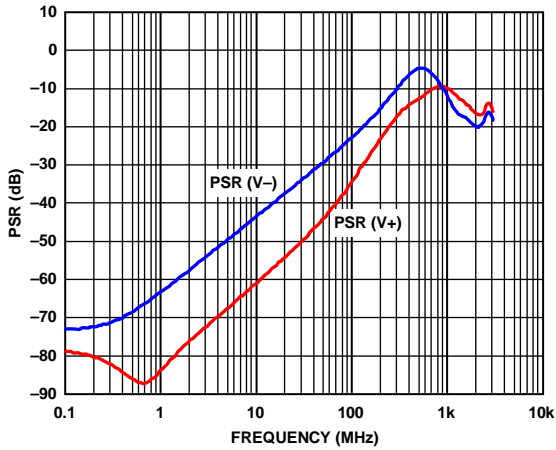

Figure 31. ADV3221 PSR

08652-037

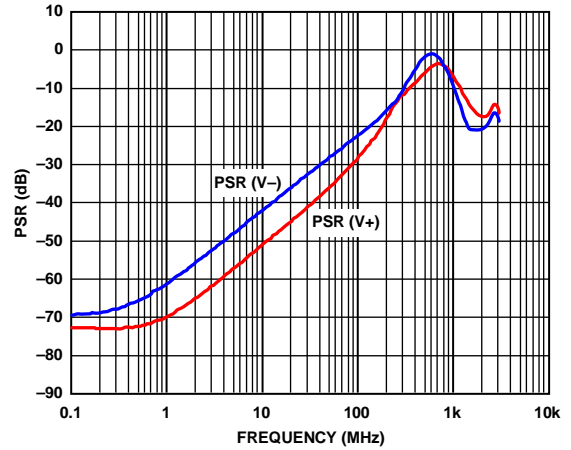

Figure 34. ADV3222 PSR

08652-040

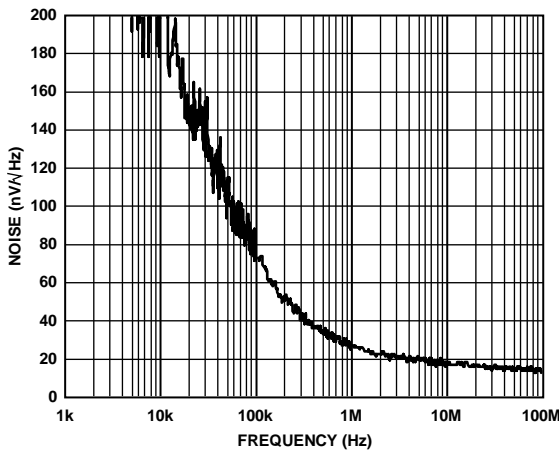

Figure 32. ADV3221 Output Noise vs. Frequency

08652-038

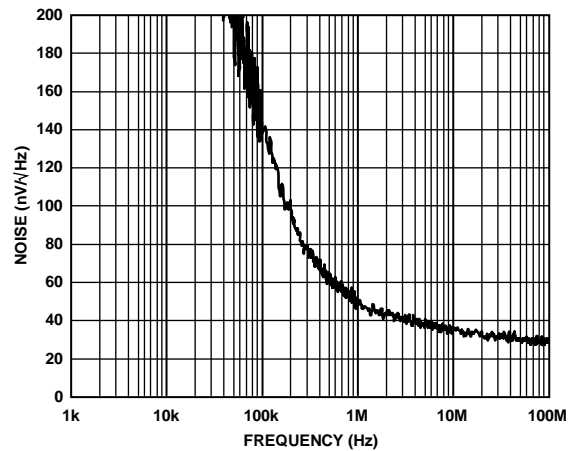

Figure 35. ADV3222 Output Noise vs. Frequency

08652-041

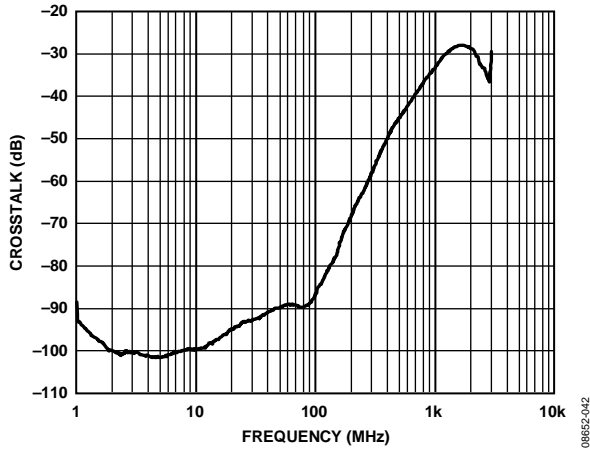

Figure 36. ADV3221 All Hostile Crosstalk

08652-042

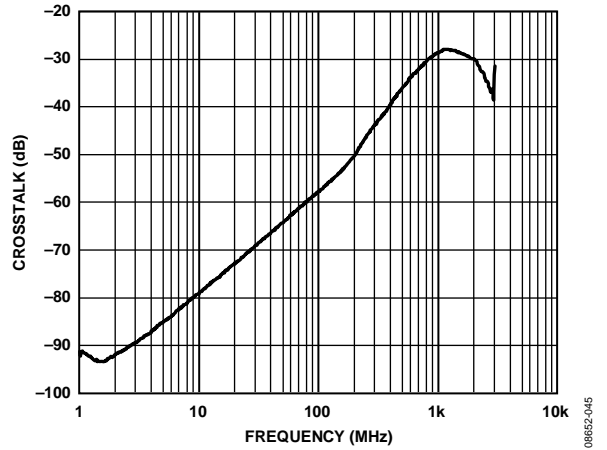

Figure 39. ADV3222 All Hostile Crosstalk

08652-045

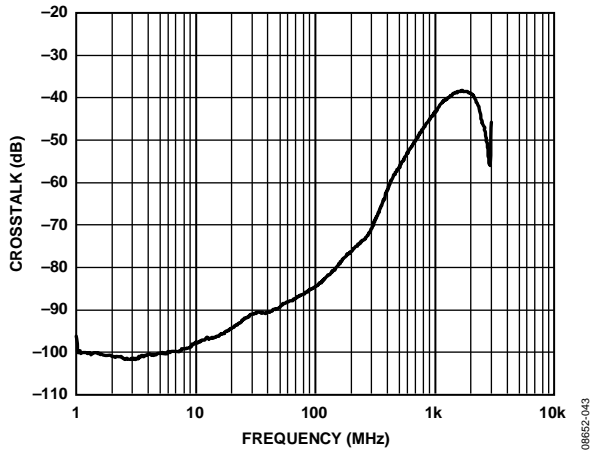

Figure 37. ADV3221 Crosstalk, Adjacent Channel

08652-043

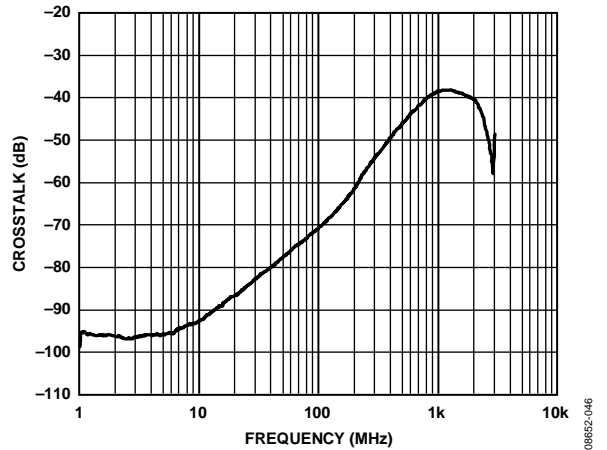

Figure 40. ADV3222 Crosstalk, Adjacent Channel

08652-046

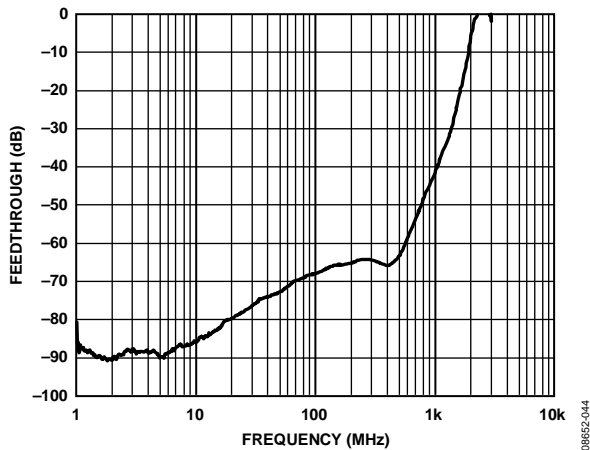

Figure 38. ADV3221 Off Isolation

08652-044

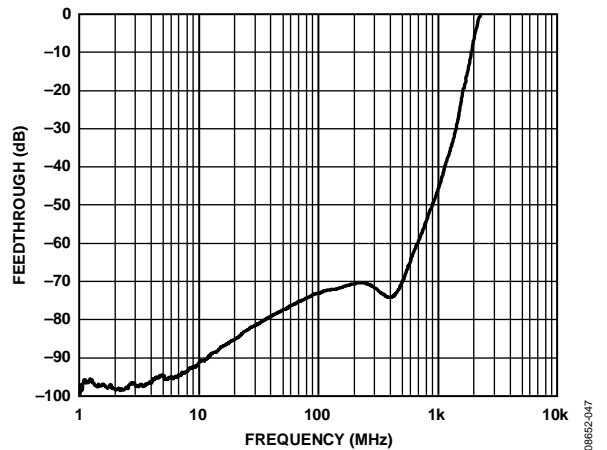

Figure 41. ADV3222 Off Isolation

08652-047

# ADV3221/ADV3222

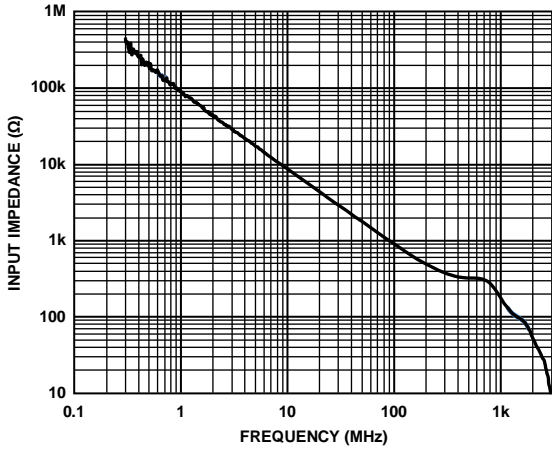

Figure 42. ADV3221/ADV3222 Input Impedance

08652-048

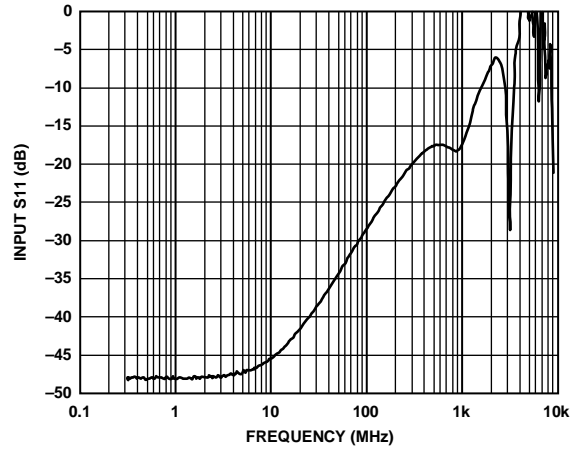

Figure 45. ADV3221/ADV3222 S11 (Including Evaluation Board)

08652-051

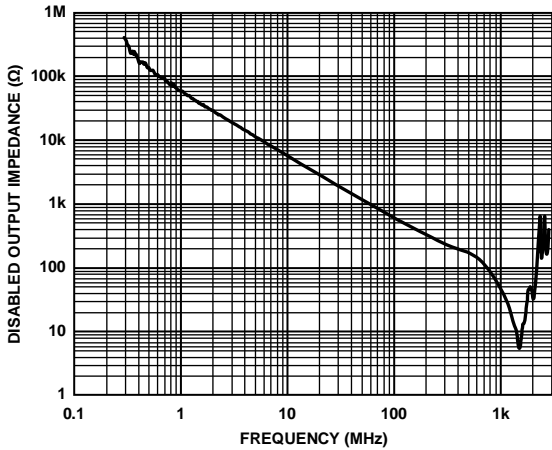

Figure 43. ADV3221 Disabled Output Impedance

08652-049

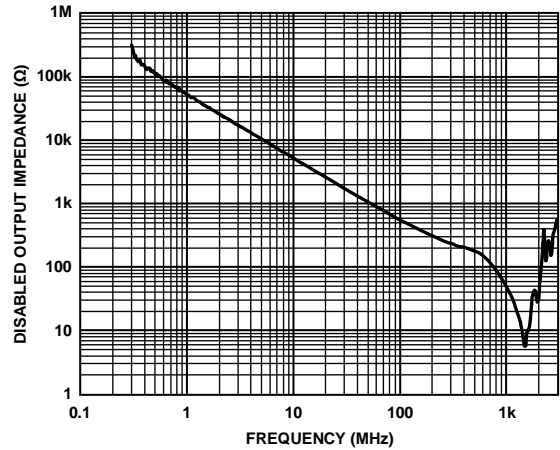

Figure 46. ADV3222 Disabled Output Impedance

08652-052

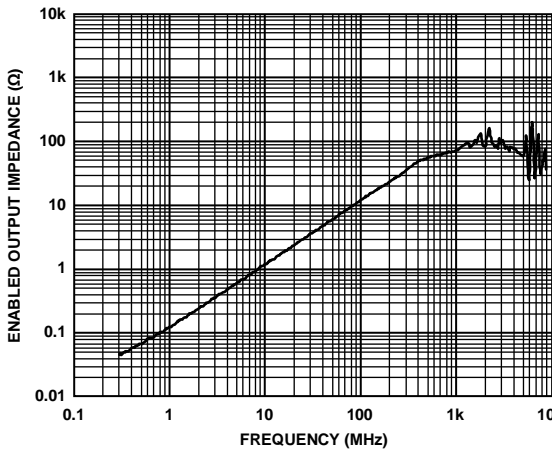

Figure 44. ADV3221 Enabled Output Impedance

08652-050

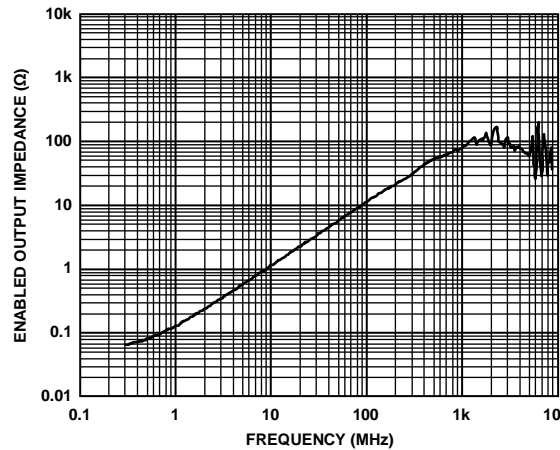

Figure 47. ADV3222 Enabled Output Impedance

08652-053

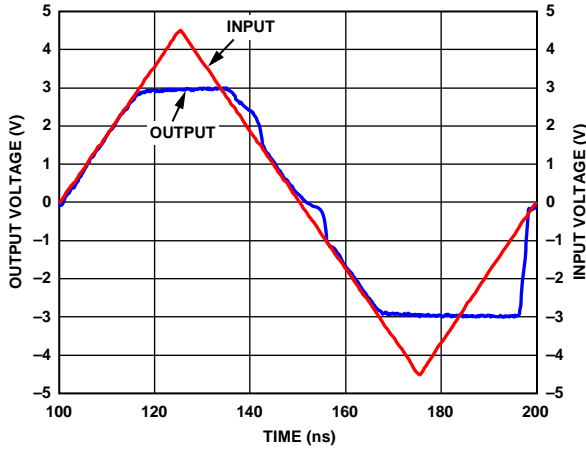

Figure 48. ADV3221 Overdrive Recovery

08652-054

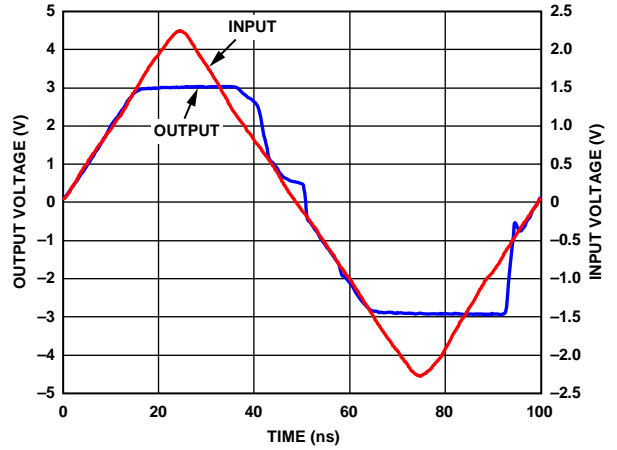

Figure 51. ADV3222 Overdrive Recovery

08652-057

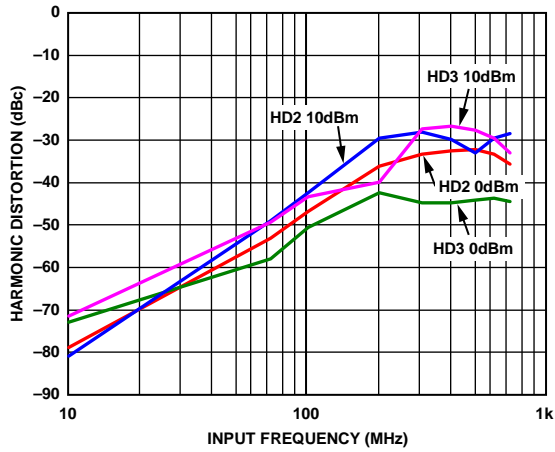

Figure 49. ADV3222 Harmonic Distortion,  $R_L = 100 \Omega$ ,  $C_L = 4 \text{ pF}$

08652-055

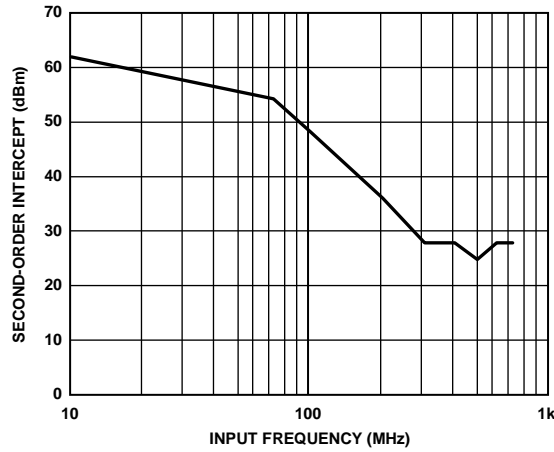

Figure 52. ADV3222 Input Second-Order Intercept,  $R_L = 100 \Omega$ ,  $C_L = 4 \text{ pF}$

08652-058

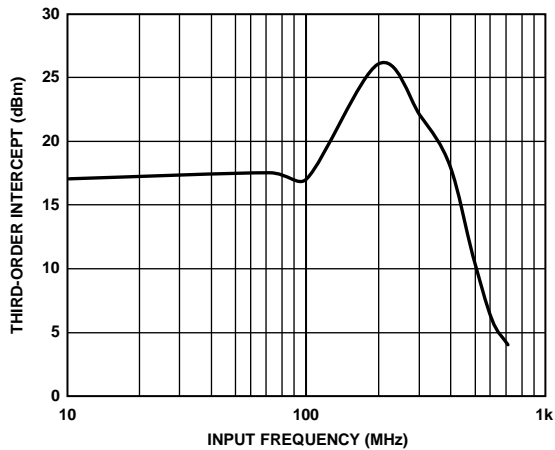

Figure 50. ADV3222 Input Third-Order Intercept,  $R_L = 100 \Omega$ ,  $C_L = 4 \text{ pF}$

08652-056

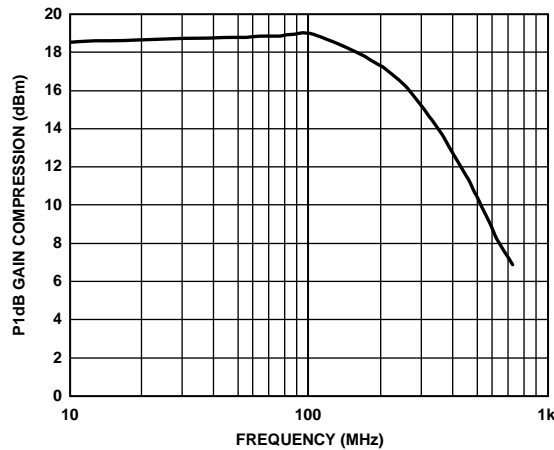

Figure 53. ADV3222 Output P1dB,  $R_L = 100 \Omega$ ,  $C_L = 4 \text{ pF}$

08652-059

## CIRCUIT DIAGRAMS

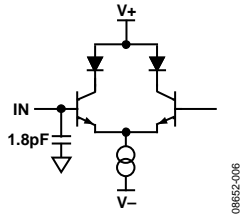

Figure 54. ADV3221/ADV3222 Analog Input

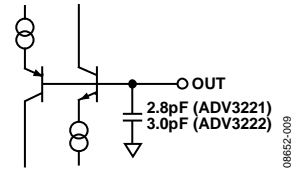

Figure 57. ADV3221/ADV3222 Disabled Output

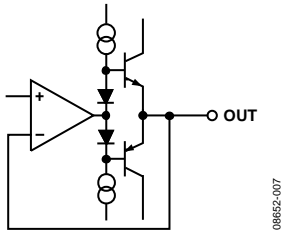

Figure 55. ADV3221 Enabled Analog Output

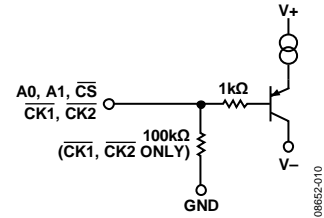

Figure 58. ADV3221/ADV3222 Logic Input

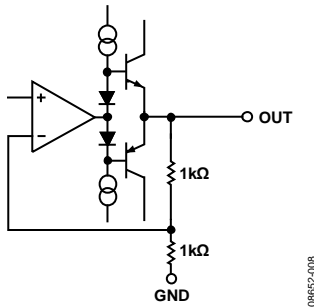

Figure 56. ADV3222 Enabled Analog Output

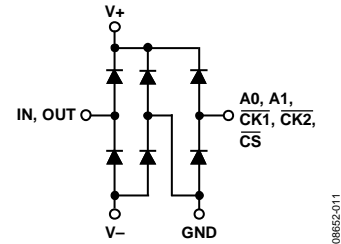

Figure 59. ADV3221/ADV3222 ESD Schematic



## THEORY OF OPERATION

The ADV3221/ADV3222 are dual-supply, high performance 4:1 analog multiplexers, optimized for switching between multiple video sources. High peak slew rates enable wide bandwidth operation for large input signals. Internal compensation provides for high phase margin, allowing low overshoot and fast settling for pulsed inputs. Low enabled and disabled power consumption make the ADV3221 and ADV3222 ideal for constructing larger arrays.

The ADV3221/ADV3222 are organized as four input transconductance stages tied in parallel with a single output transimpedance stage followed by a unity-gain buffer. Internal voltage feedback sets the gain. The ADV3221 is configured as a gain of 1, while the ADV3222 uses a resistive feedback network and ground buffer to realize gain-of-two operation (see Figure 60).

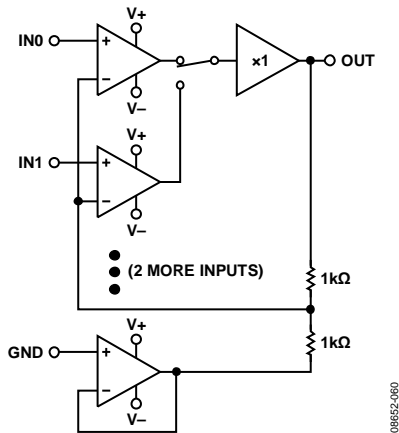

Figure 60. Conceptual Diagram of ADV3222

When not in use, the output can be placed in a low power, high impedance disabled mode via the  $\overline{CS}$  logic input. This is useful when paralleling multiple ADV3221/ADV3222 devices in a system to create larger switching arrays.

Switching between the inputs is controlled with the A0, A1, and  $\overline{CS}$  logic inputs, which are latched through two stages of asynchronous latches.  $\overline{CK1}$  controls the first stage latch, and  $\overline{CK2}$  controls the second stage latch. The latch state is dependent on the level of the  $\overline{CK1}$  and  $\overline{CK2}$  signals, and it is not edge triggered. When using multiple ADV3221/ADV3222 devices in a switch design, this double buffered logic allows the use of the  $\overline{CK2}$  signal to simultaneously update all ADV3221/ADV3222 devices in a system. The A0 and A1 logic inputs select which input is connected to the output (A1 is the most significant bit, A0 is the least significant bit), and the  $\overline{CS}$  logic input determines whether the output is enabled or disabled.

## APPLICATIONS INFORMATION

The ADV3221 and ADV3222 are high speed multiplexers used to switch video or RF signals. The low output impedance of the ADV3221/ADV3222 allows the output environment to be optimized for use in 75  $\Omega$  or 50  $\Omega$  systems by choosing the appropriate series termination resistor. For composite video applications, the ADV3222 (gain of +2) is typically used to provide compensation for the loss of the output termination.

### CK1/CK2 OPERATION

The ADV3221/ADV3222 provide a double latched architecture for the A0, A1 (channel selection) and  $\overline{CS}$  (output enable) logic. This allows for simultaneous update of multiple devices in bank switching applications or large multiplexer systems consisting of multiple devices connected to common output busses.

Holding  $\overline{CK1}$  and  $\overline{CK2}$  low places the ADV3221/ADV3222 in a transparent mode. In transparent mode, all logic changes to A0, A1, and  $\overline{CS}$  immediately affects the input selection and output enable/disable.

### CIRCUIT LAYOUT

Use of proper high speed design techniques is important to ensure optimum performance. Use a low inductance ground plane for power supply bypassing and to provide high quality return paths for the input and output signals. For best performance, it is recommended that power supplies be bypassed with 0.1  $\mu\text{F}$  ceramic capacitors as close to the body of the device as possible. To provide stored energy for lower frequency, high current output driving, place 10  $\mu\text{F}$  tantalum capacitors farther from the device.

The input and output signal paths should be stripline or microstrip controlled impedance. Video systems typically use 75  $\Omega$  characteristic impedance, whereas RF systems typically use 50  $\Omega$ . Various calculators are available to calculate the trace geometry required to produce the proper characteristic impedance.

### TERMINATION

For a controlled impedance situation, termination resistors are required at the inputs and output of the device. The input termination should be a shunt resistor to ground with a value matching the characteristic impedance of the input trace. To reduce reflections, place the input termination resistor as close to the device input pin as possible. To minimize the input-to-input crosstalk, it is important to utilize a low inductance shield between input traces to isolate each input. Consideration of ground current paths must be taken to minimize loop currents in the shields to prevent them from providing a coupling medium for crosstalk.

For proper matching, the output series termination resistor should be the same value as the characteristic impedance of the output trace and placed as close to the output of the device as possible. This placement reduces the high frequency effect of series parasitic inductance, which can affect gain flatness and -3 dB bandwidth.

### CAPACITIVE LOAD

A high frequency output can have difficulties when driving a large capacitive load, usually resulting in peaking in the frequency domain or overshoot in the time domain. If these effects become too large, oscillation can result.

The response of the device under various capacitive loads is shown in Figure 6 through Figure 12, and in Figure 15. If a condition arises where excessive load capacitance is encountered and the overshoot is too great or the device oscillates, a small series resistor of a few tens of ohms can be used to improve the performance.

# OUTLINE DIMENSIONS

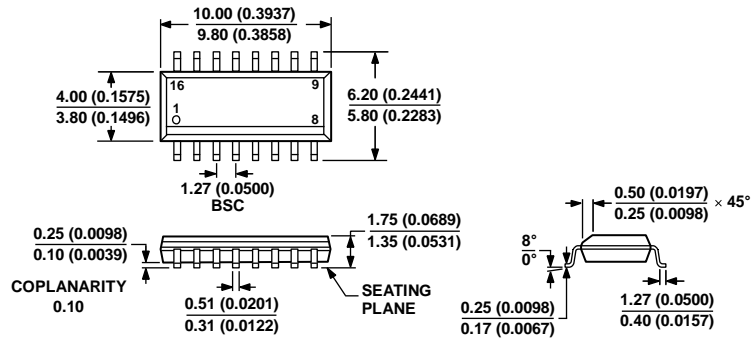

COMPLIANT TO JEDEC STANDARDS MS-012-AC  
 CONTROLLING DIMENSIONS ARE IN MILLIMETERS; INCH DIMENSIONS (IN PARENTHESES) ARE ROUNDED-OFF MILLIMETER EQUIVALENTS FOR REFERENCE ONLY AND ARE NOT APPROPRIATE FOR USE IN DESIGN.

Figure 61. 16-Lead Standard Small Outline Package [SOIC\_N]  
 Narrow Body  
 [R-16]  
 Dimensions shown in millimeters and (inches)

060606-A

## ORDERING GUIDE

Model <sup>1</sup>	Temperature Range	Package Description	Package Option
ADV3221ARZ	-40°C to +85°C	16-Lead SOIC_N	R-16
ADV3221ARZ-RL	-40°C to +85°C	16-Lead SOIC_N, 13" Reel	R-16
ADV3221ARZ-R7	-40°C to +85°C	16-Lead SOIC_N, 7" Reel	R-16
ADV3222ARZ	-40°C to +85°C	16-Lead SOIC_N	R-16
ADV3222ARZ-RL	-40°C to +85°C	16-Lead SOIC_N, 13" Reel	R-16
ADV3222ARZ-R7	-40°C to +85°C	16-Lead SOIC_N, 7" Reel	R-16
ADV3221-EVALZ		Evaluation Board	
ADV3222-EVALZ		Evaluation Board	

<sup>1</sup> Z = RoHS Compliant Part.

**NOTES**



Компания «ЭлектроПласт» предлагает заключение долгосрочных отношений при поставках импортных электронных компонентов на взаимовыгодных условиях!

Наши преимущества:

- Оперативные поставки широкого спектра электронных компонентов отечественного и импортного производства напрямую от производителей и с крупнейших мировых складов;
- Поставка более 17-ти миллионов наименований электронных компонентов;
- Поставка сложных, дефицитных, либо снятых с производства позиций;
- Оперативные сроки поставки под заказ (от 5 рабочих дней);
- Экспресс доставка в любую точку России;
- Техническая поддержка проекта, помощь в подборе аналогов, поставка прототипов;
- Система менеджмента качества сертифицирована по Международному стандарту ISO 9001;
- Лицензия ФСБ на осуществление работ с использованием сведений, составляющих государственную тайну;
- Поставка специализированных компонентов (Xilinx, Altera, Analog Devices, Intersil, Interpoint, Microsemi, Aeroflex, Peregrine, Syfer, Eurofarad, Texas Instrument, Miteq, Cobham, E2V, MA-COM, Hittite, Mini-Circuits, General Dynamics и др.);

Помимо этого, одним из направлений компании «ЭлектроПласт» является направление «Источники питания». Мы предлагаем Вам помощь Конструкторского отдела:

- Подбор оптимального решения, техническое обоснование при выборе компонента;
- Подбор аналогов;
- Консультации по применению компонента;
- Поставка образцов и прототипов;
- Техническая поддержка проекта;
- Защита от снятия компонента с производства.



#### Как с нами связаться

**Телефон:** 8 (812) 309 58 32 (многоканальный)

**Факс:** 8 (812) 320-02-42

**Электронная почта:** [org@eplast1.ru](mailto:org@eplast1.ru)

**Адрес:** 198099, г. Санкт-Петербург, ул. Калинина, дом 2, корпус 4, литера А.