

THIS DRAWING IS UNPUBLISHED. RELEASED FOR PUBLICATION  
 © COPYRIGHT BY TYCO ELECTRONICS CORPORATION. ALL RIGHTS RESERVED.

LOC		DIST		REVISIONS			
P	LTR	DATE	DWN	APVD			
AD	00						
	H	REVISED PER EC 0512-0273-05	19SEP05	JDP	DD		

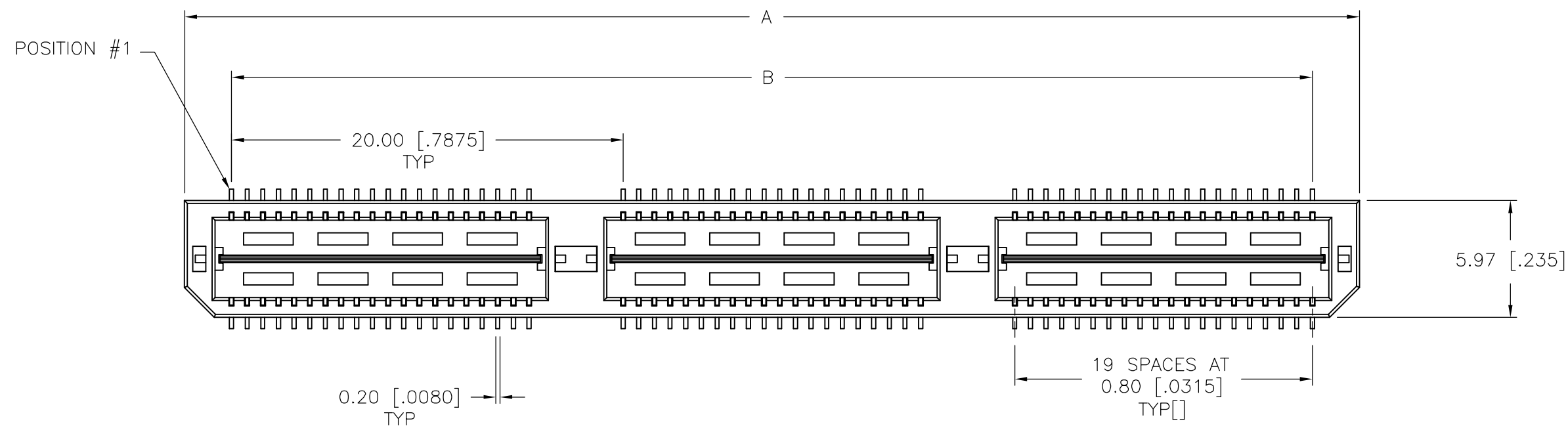

- 1 HOUSING: LCP, BLACK.  
CONTACT & GROUND PLANE: PHOS BRONZE.
- 2 CONTACT PLATING: SELECT 0.25 MICROMETERS (.000010 IN.) MIN. GOLD.
- 3 FOR STANDARD APPLICATIONS, ORIENTATION HOLE TO BE  $\phi 1.02$  [ $\phi .0400$ ].

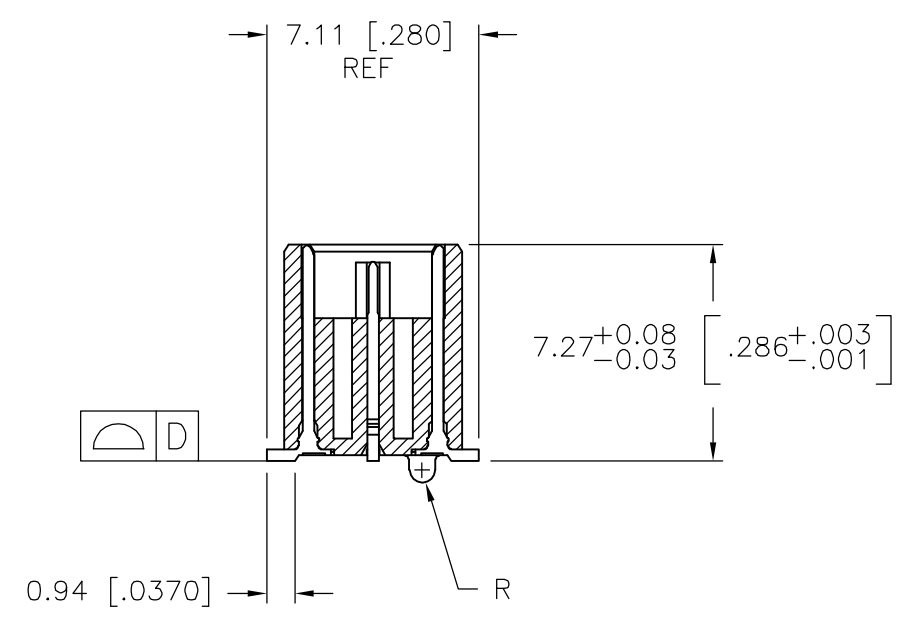
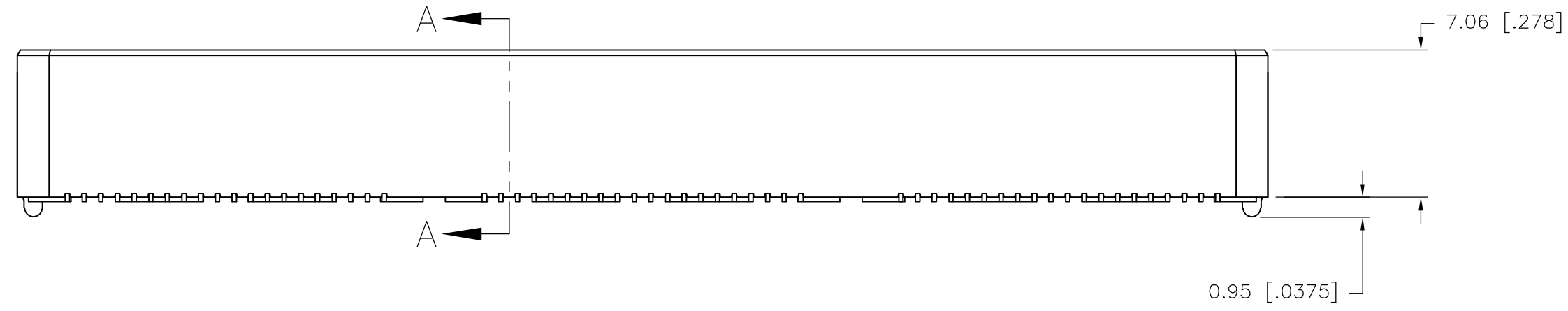

SECTION A-A

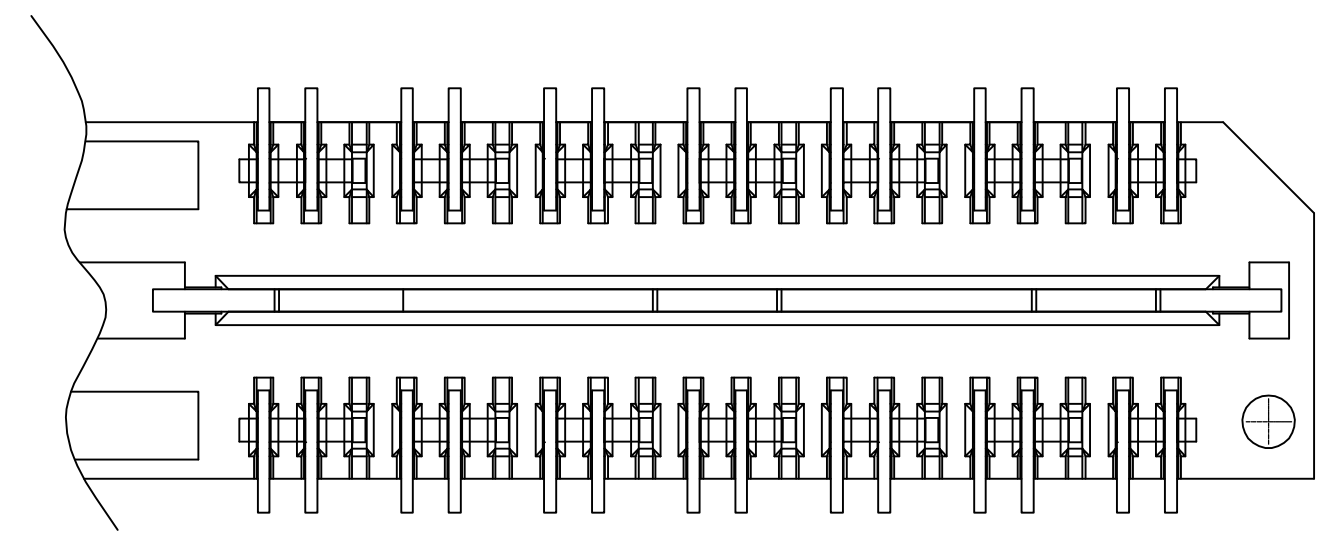
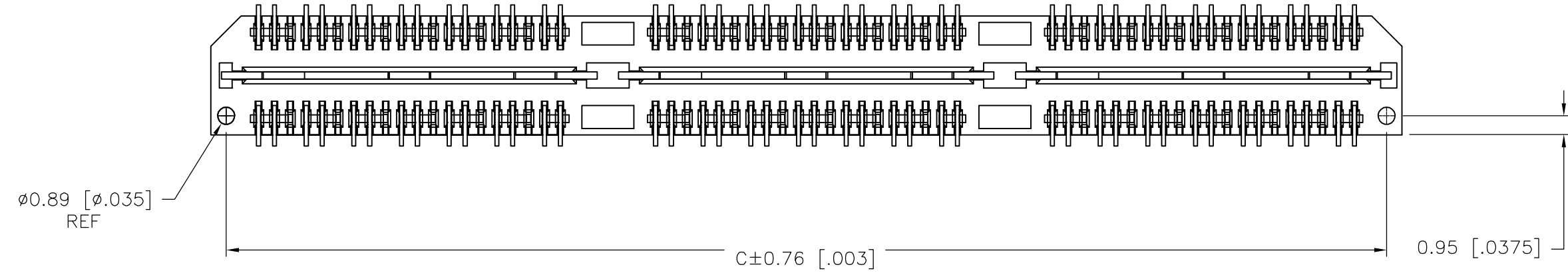

DIFFERENTIAL PAIR LOADING  
(BOTTOM VIEW)  
SCALE 2:1

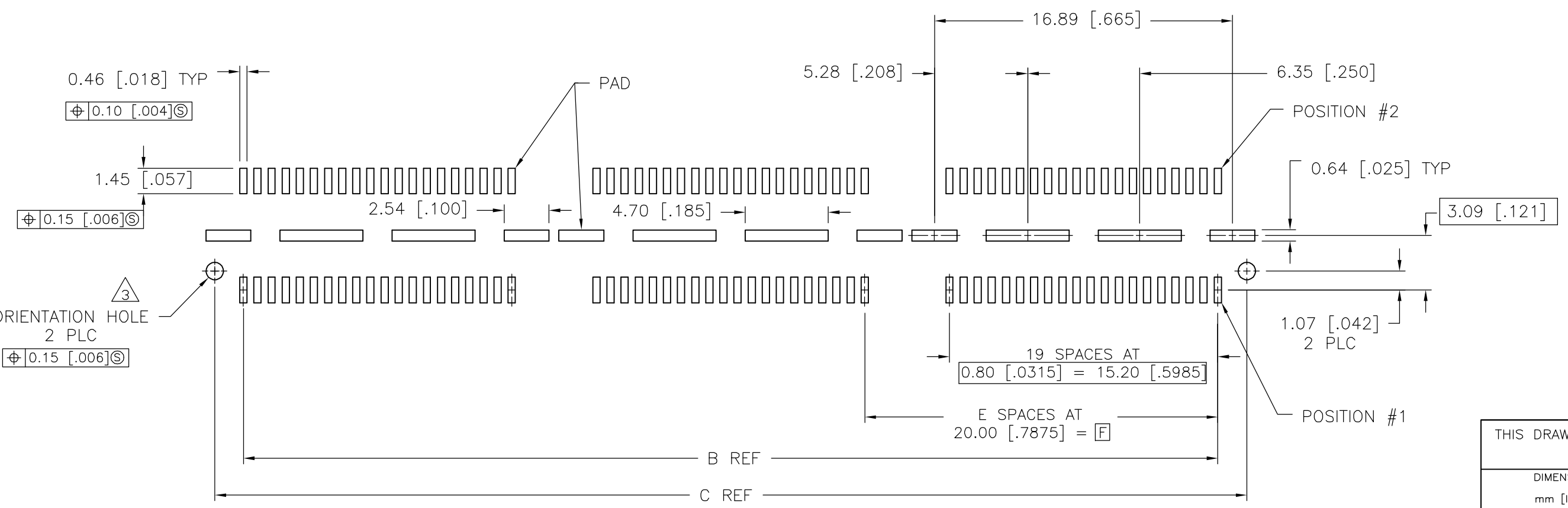

RECOMMENDED PC BOARD LAYOUT  
(VIEWED FROM CONNECTOR SIDE)

THIS DRAWING IS A CONTROLLED DOCUMENT.		DWN B.CARBO 30JAN03	Tyco Electronics Corporation Harrisburg, PA 17105-3608
DIMENSIONS: mm [INCHES]		CHK D.DIXON 30JAN03	
TOLERANCES UNLESS OTHERWISE SPECIFIED:		APVD D.DIXON 30JAN03	NAME
0 PLC ± -		PRODUCT SPEC	HEADER ASSEMBLY, 8.0MM [.315] VERTICAL, 0.80MM CL, MICTOR SB
1 PLC ± 0.3[.01]		APPLICATION SPEC	SIZE CAGE CODE DRAWING NO RESTRICTED TO
2 PLC ± 0.13[.005]			A2 00779 C=1658014
3 PLC ± 0.051[.0020]			SCALE 3:1 SHEET 1 of 2 REV H
4 PLC ± -			
ANGLES ± 2°			
MATERIAL	1	WEIGHT -	
	2	CUSTOMER DRAWING	

THIS DRAWING IS UNPUBLISHED. RELEASED FOR PUBLICATION  
 © COPYRIGHT BY TYCO ELECTRONICS CORPORATION. ALL RIGHTS RESERVED.

LOC	DIST	REVISIONS			
P	LTR	DESCRIPTION	DATE	DWN	APVD
AD	00	SEE SHEET 1	-	-	-

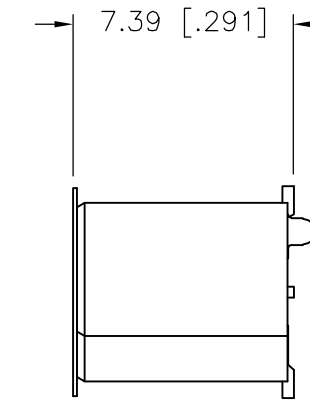
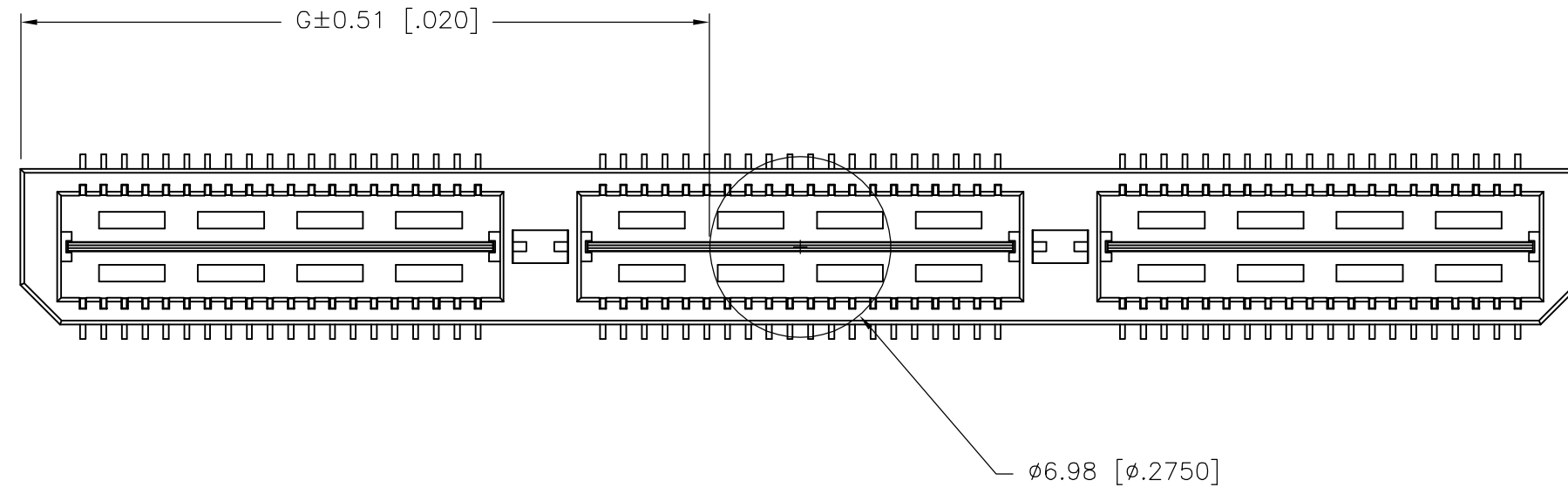

G	F	E	D	C	B	A	POLYIMIDE FILM PAD ▲	PACKAGING TYPE	DIFF. PAIR	NO OF POS	PART NUMBER
26.52(1.044)	40.00(1.575)	2	0.102(.0040)	58.50(2.303)	55.20(2.173)	60.00(2.362)	YES	POCKET TAPE	YES	84	7-1658014-3
16.51(.650)	20.00(.7874)	1	0.102(.0040)	38.48(1.515)	35.20(1.386)	40.00(1.575)	YES	POCKET TAPE	YES	56	7-1658014-2
6.50(.256)	0(.000)	0	0.102(.0040)	18.49(.728)	15.20(.598)	20.00(.787)	YES	POCKET TAPE	YES	28	7-1658014-1
26.52(1.044)	40.00(1.575)	2	0.102(.0040)	58.50(2.303)	55.20(2.173)	60.00(2.362)	YES	POCKET TAPE	NO	120	6-1658014-3
16.51(.650)	20.00(.7874)	1	0.102(.0040)	38.48(1.515)	35.20(1.386)	40.00(1.575)	YES	POCKET TAPE	NO	80	6-1658014-2
6.50(.256)	0(.000)	0	0.102(.0040)	18.49(.728)	15.20(.598)	20.00(.787)	YES	POCKET TAPE	NO	40	6-1658014-1
-	40.00(1.575)	2	0.102(.0040)	58.50(2.303)	55.20(2.173)	60.00(2.362)	NO	POCKET TAPE	YES	84	5-1658014-3
-	20.00(.7874)	1	0.102(.0040)	38.48(1.515)	35.20(1.386)	40.00(1.575)	NO	POCKET TAPE	YES	56	5-1658014-2
-	0(.000)	0	0.102(.0040)	18.49(.728)	15.20(.598)	20.00(.787)	NO	POCKET TAPE	YES	28	5-1658014-1
-	40.00(1.575)	2	0.102(.0040)	58.50(2.303)	55.20(2.173)	60.00(2.362)	NO	POCKET TAPE	NO	120	4-1658014-3
-	20.00(.7874)	1	0.102(.0040)	38.48(1.515)	35.20(1.386)	40.00(1.575)	NO	POCKET TAPE	NO	80	4-1658014-2
-	0(.000)	0	0.102(.0040)	18.49(.728)	15.20(.598)	20.00(.787)	NO	POCKET TAPE	NO	40	4-1658014-1
46.51(1.831)	80.00(3.150)	4	0.152(.0060)	98.50(3.748)	95.20(3.748)	100.00(3.937)	YES	TRAY	YES	140	3-1658014-5
36.53(1.438)	60.00(2.362)	3	0.152(.0060)	78.49(3.090)	75.20(2.961)	80.00(3.150)	YES	TRAY	YES	112	3-1658014-4
26.52(1.044)	40.00(1.575)	2	0.102(.0040)	58.50(2.303)	55.20(2.173)	60.00(2.362)	YES	TRAY	YES	84	3-1658014-3
16.51(.650)	20.00(.7874)	1	0.102(.0040)	38.48(1.515)	35.20(1.386)	40.00(1.575)	YES	TRAY	YES	56	3-1658014-2
6.50(.256)	0(.000)	0	0.102(.0040)	18.49(.728)	15.20(.598)	20.00(.787)	YES	TRAY	YES	28	3-1658014-1
46.51(1.831)	80.00(3.150)	4	0.152(.0060)	98.50(3.748)	95.20(3.748)	100.00(3.937)	YES	TRAY	NO	200	2-1658014-5
36.53(1.438)	60.00(2.362)	3	0.152(.0060)	78.49(3.090)	75.20(2.961)	80.00(3.150)	YES	TRAY	NO	160	2-1658014-4
26.52(1.044)	40.00(1.575)	2	0.102(.0040)	58.50(2.303)	55.20(2.173)	60.00(2.362)	YES	TRAY	NO	120	2-1658014-3
16.51(.650)	20.00(.7874)	1	0.102(.0040)	38.48(1.515)	35.20(1.386)	40.00(1.575)	YES	TRAY	NO	80	2-1658014-2
6.50(.256)	0(.000)	0	0.102(.0040)	18.49(.728)	15.20(.598)	20.00(.787)	YES	TRAY	NO	40	2-1658014-1
-	80.00(3.150)	4	0.152(.0060)	98.50(3.748)	95.20(3.748)	100.00(3.937)	NO	TRAY	YES	140	1-1658014-5
-	60.00(2.362)	3	0.152(.0060)	78.49(3.090)	75.20(2.961)	80.00(3.150)	NO	TRAY	YES	112	1-1658014-4
-	40.00(1.575)	2	0.102(.0040)	58.50(2.303)	55.20(2.173)	60.00(2.362)	NO	TRAY	YES	84	1-1658014-3
-	20.00(.7874)	1	0.102(.0040)	38.48(1.515)	35.20(1.386)	40.00(1.575)	NO	TRAY	YES	56	1-1658014-2
-	0(.000)	0	0.102(.0040)	18.49(.728)	15.20(.598)	20.00(.787)	NO	TRAY	YES	28	1-1658014-1
-	80.00(3.150)	4	0.152(.0060)	98.50(3.748)	95.20(3.748)	100.00(3.937)	NO	TRAY	NO	200	1658014-5
-	60.00(2.362)	3	0.152(.0060)	78.49(3.090)	75.20(2.961)	80.00(3.150)	NO	TRAY	NO	160	1658014-4
-	40.00(1.575)	2	0.102(.0040)	58.50(2.303)	55.20(2.173)	60.00(2.362)	NO	TRAY	NO	120	1658014-3
-	20.00(.7874)	1	0.102(.0040)	38.48(1.515)	35.20(1.386)	40.00(1.575)	NO	TRAY	NO	80	1658014-2
-	0(.000)	0	0.102(.0040)	18.49(.728)	15.20(.598)	20.00(.787)	NO	TRAY	NO	40	1658014-1

THIS DRAWING IS A CONTROLLED DOCUMENT.

DWN B.CARRO 30JAN03  
 CHK D.DIXON 30JAN03  
 APVD D.DIXON 30JAN03

TOLERANCES UNLESS OTHERWISE SPECIFIED:  
 0 PLC ± -  
 1 PLC ± 0.3[.01]  
 2 PLC ± 0.13[.005]  
 3 PLC ± 0.05[.0020]  
 4 PLC ± -  
 ANGLES ± 2'

MATERIAL FINISH SEE SHEET 1

WEIGHT -

CUSTOMER DRAWING

**tyco Electronics** Tyco Electronics Corporation  
 Harrisburg, PA 17105-3608

NAME: HEADER ASSEMBLY, 8.0MM [.315] VERTICAL, 0.80MM CL, MICTOR SB

SIZE: A2 CAGE CODE: 00779 DRAWING NO: C=1658014 RESTRICTED TO: -

SCALE: 3:1 SHEET: 2 of 2 REV: H



Компания «ЭлектроПласт» предлагает заключение долгосрочных отношений при поставках импортных электронных компонентов на взаимовыгодных условиях!

Наши преимущества:

- Оперативные поставки широкого спектра электронных компонентов отечественного и импортного производства напрямую от производителей и с крупнейших мировых складов;
- Поставка более 17-ти миллионов наименований электронных компонентов;
- Поставка сложных, дефицитных, либо снятых с производства позиций;
- Оперативные сроки поставки под заказ (от 5 рабочих дней);
- Экспресс доставка в любую точку России;
- Техническая поддержка проекта, помощь в подборе аналогов, поставка прототипов;
- Система менеджмента качества сертифицирована по Международному стандарту ISO 9001;
- Лицензия ФСБ на осуществление работ с использованием сведений, составляющих государственную тайну;
- Поставка специализированных компонентов (Xilinx, Altera, Analog Devices, Intersil, Interpoint, Microsemi, Aeroflex, Peregrine, Syfer, Eurofarad, Texas Instrument, Miteq, Cobham, E2V, MA-COM, Hittite, Mini-Circuits, General Dynamics и др.);

Помимо этого, одним из направлений компании «ЭлектроПласт» является направление «Источники питания». Мы предлагаем Вам помощь Конструкторского отдела:

- Подбор оптимального решения, техническое обоснование при выборе компонента;
- Подбор аналогов;
- Консультации по применению компонента;
- Поставка образцов и прототипов;
- Техническая поддержка проекта;
- Защита от снятия компонента с производства.



#### Как с нами связаться

**Телефон:** 8 (812) 309 58 32 (многоканальный)

**Факс:** 8 (812) 320-02-42

**Электронная почта:** [org@eplast1.ru](mailto:org@eplast1.ru)

**Адрес:** 198099, г. Санкт-Петербург, ул. Калинина, дом 2, корпус 4, литера А.