



Standard Recovery Diodes (Hockey PUK), 2100 A



DO-200AC (K-PUK)

FEATURES

- Wide current range
- High voltage ratings up to 4500 V
- High surge current capabilities
- Diffused junction
- Hockey PUK version
- Case style DO-200AC (K-PUK)
- Material categorization: For definitions of compliance please see www.vishay.com/doc?99912



RoHS
COMPLIANT

TYPICAL APPLICATIONS

- Converters
- Power supplies
- Machine tool controls
- High power drives
- Medium traction applications

PRODUCT SUMMARY	
$I_{F(AV)}$	2100 A
Package	DO-200AC (K-PUK)
Circuit configuration	Single diode

MAJOR RATINGS AND CHARACTERISTICS				
PARAMETER	TEST CONDITIONS	SD1700C..K		UNITS
		24 to 36	40 to 45	
$I_{F(AV)}$		2080	1875	A
	T_{hs}	55	55	°C
$I_{F(RMS)}$		3600	3280	A
	T_{hs}	25	25	°C
I_{FSM}	50 Hz	24 000	20 000	A
	60 Hz	25 150	20 950	
I^2t	50 Hz	2890	2000	kA ² s
	60 Hz	2630	1826	
V_{RRM}	Range	2400 to 3600	4000 to 4500	V
T_J		-40 to 150		°C

ELECTRICAL SPECIFICATIONS

VOLTAGE RATINGS				
TYPE NUMBER	VOLTAGE CODE	V_{RRM} , MAXIMUM REPETITIVE PEAK REVERSE VOLTAGE V	V_{RSM} , MAXIMUM NON-REPETITIVE PEAK REVERSE VOLTAGE V	I_{RRM} MAXIMUM AT $T_J = T_J$ MAXIMUM mA
VS-SD1700C..K	24	2400	2500	75
	30	3000	3100	
	36	3600	3700	
	40	4000	4100	
	45	4500	4600	



FORWARD CONDUCTION							
PARAMETER	SYMBOL	TEST CONDITIONS		SD1700C..K		UNITS	
				24 to 36	40 to 45		
Maximum average forward current at heatsink temperature	$I_{F(AV)}$	180° conduction, half sine wave Double side (single side) cooled		2080 (1000)	1875 (920)	A	
				55 (85)	55 (85)	°C	
Maximum RMS forward current	$I_{F(RMS)}$	25 °C heatsink temperature double side cooled		3600	3280		
Maximum peak, one cycle forward, non-repetitive surge current	I_{FSM}	t = 10 ms	No voltage reapplied	Sinusoidal half wave, initial $T_J = T_J$ maximum	24 000	20 000	A
		t = 8.3 ms			25 150	20 950	
		t = 10 ms	50 % V_{RRM} reapplied		20 200	16 800	
		t = 8.3 ms			21 150	17 600	
Maximum I^2t for fusing	I^2t	t = 10 ms	No voltage reapplied		2890	2000	kA ² s
		t = 8.3 ms			2630	1826	
		t = 10 ms	50 % V_{RRM} reapplied		2040	1415	
		t = 8.3 ms			1860	1292	
Maximum $I^2\sqrt{t}$ for fusing	$I^2\sqrt{t}$	t = 0.1 to 10 ms, no voltage reapplied		28 900	20 000	kA ² √s	
Low level value of threshold voltage	$V_{F(TO)1}$	(16.7 % $\times \pi \times I_{F(AV)} < I < \pi \times I_{F(AV)}$, $T_J = T_J$ maximum)		0.89	0.88	V	
High level value of threshold voltage	$V_{F(TO)2}$	(I > $\pi \times I_{F(AV)}$, $T_J = T_J$ maximum)		1.02	0.99		
Low level value of forward slope resistance	r_{f1}	(16.7 % $\times \pi \times I_{F(AV)} < I < \pi \times I_{F(AV)}$, $T_J = T_J$ maximum)		0.23	0.31	mΩ	
High level value of forward slope resistance	r_{f2}	(I > $\pi \times I_{F(AV)}$, $T_J = T_J$ maximum)		0.21	0.29		
Maximum forward voltage drop	V_{FM}	$I_{pk} = 4000$ A, $T_J = T_J$ maximum, $t_p = 10$ ms sinusoidal wave		1.81	2.11	V	

THERMAL AND MECHANICAL SPECIFICATIONS				
PARAMETER	SYMBOL	TEST CONDITIONS	VALUES	UNITS
Maximum junction operating temperature range	T_J		-40 to 150	°C
Maximum storage temperature range	T_{Stg}		-55 to 200	
Maximum thermal resistance, junction to heatsink	R_{thJ-hs}	DC operation single side cooled	0.042	K/W
		DC operation double side cooled	0.020	
Mounting force, ± 10 %			22 250 (2250)	N (kg)
Approximate weight			425	g
Case style		See dimensions - link at the end of datasheet	DO-200AC (K-PUK)	

ΔR_{thJ-hs} CONDUCTION						
CONDUCTION ANGLE	SINUSOIDAL CONDUCTION		RECTANGULAR CONDUCTION		TEST CONDITIONS	UNITS
	Single Side	Double Side	Single Side	Double Side		
180°	0.002	0.002	0.001	0.001	$T_J = T_J$ maximum	K/W
120°	0.002	0.002	0.002	0.002		
90°	0.003	0.003	0.003	0.003		
60°	0.004	0.004	0.004	0.004		
30°	0.007	0.007	0.007	0.007		

Note

- The table above shows the increment of thermal resistance R_{thJ-hs} when devices operate at different conduction angles than DC

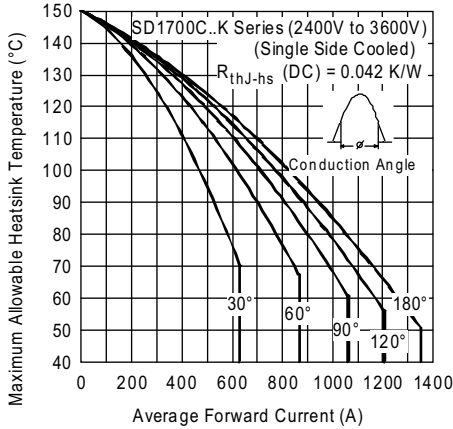

Fig. 1 - Current Ratings Characteristics

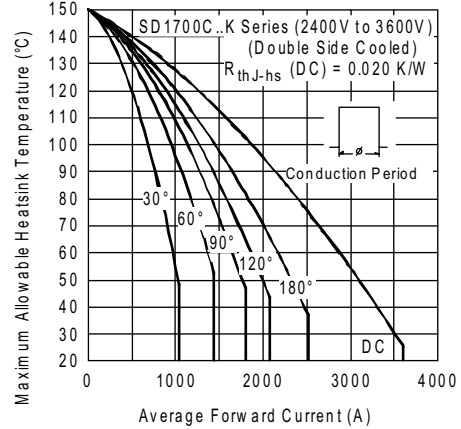

Fig. 4 - Current Ratings Characteristics

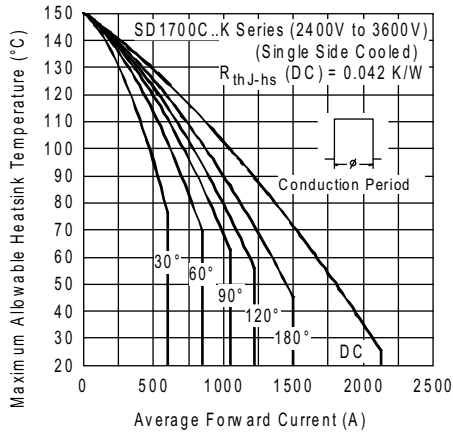

Fig. 2 - Current Ratings Characteristics

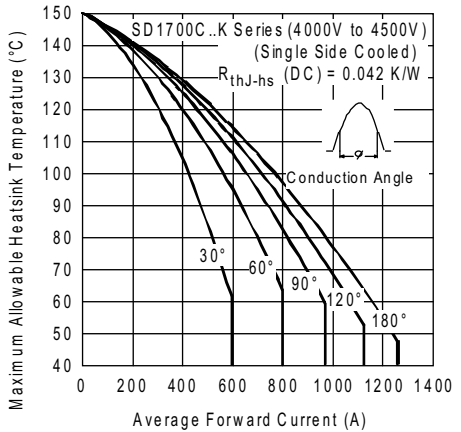

Fig. 5 - Current Ratings Characteristics

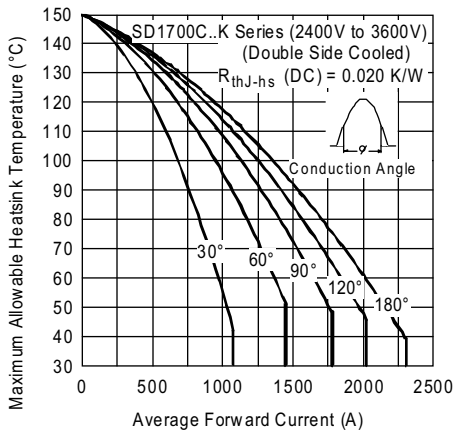

Fig. 3 - Current Ratings Characteristics

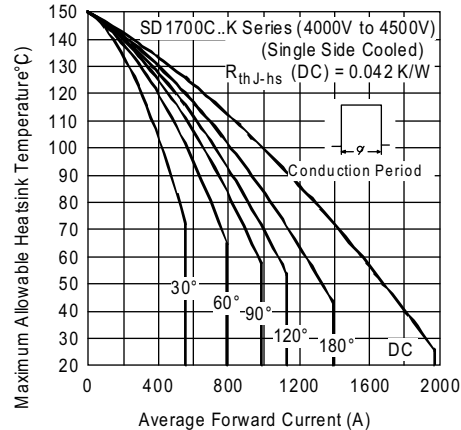

Fig. 6 - Current Ratings Characteristics

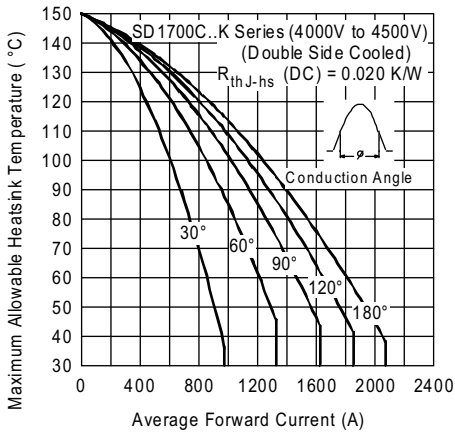

Fig. 7 - Current Ratings Characteristics

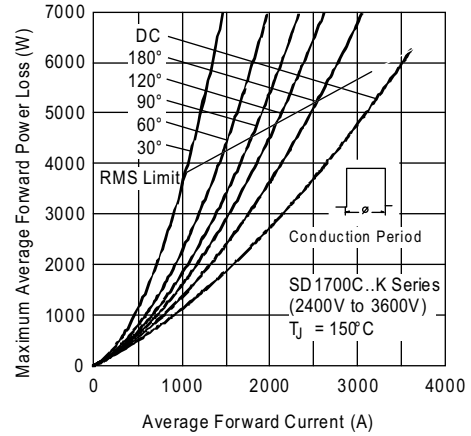

Fig. 10 - Forward Power Loss Characteristics

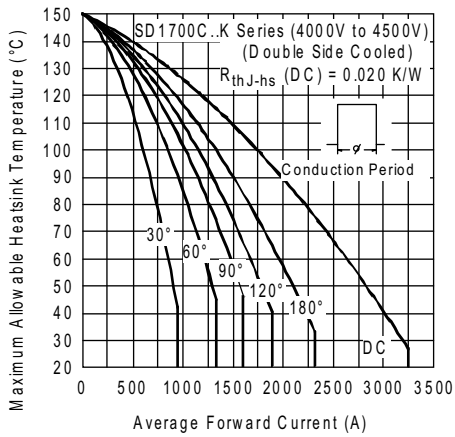

Fig. 8 - Current Ratings Characteristics

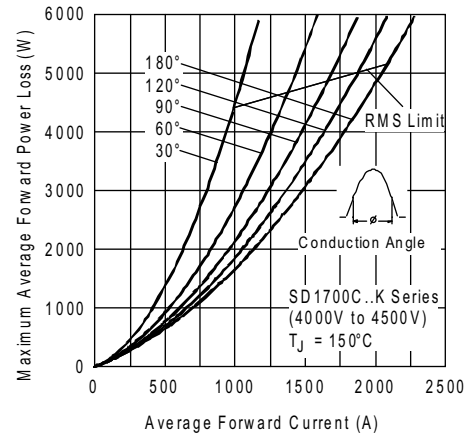

Fig. 11 - Forward Power Loss Characteristics

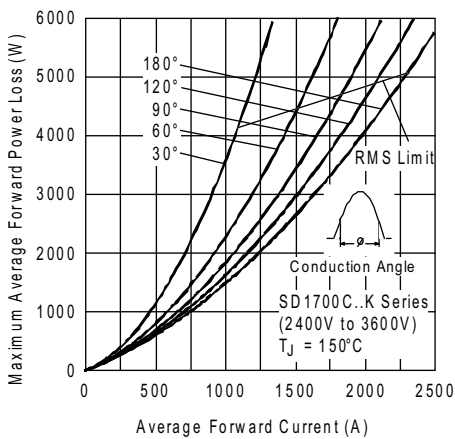

Fig. 9 - Forward Power Loss Characteristics

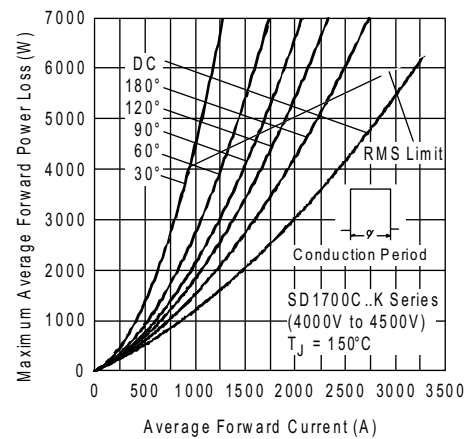

Fig. 12 - Forward Power Loss Characteristics

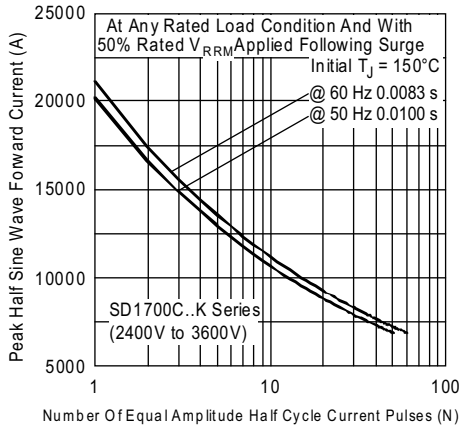

Fig. 13 - Maximum Non-Repetitive Surge Current Single and Double Side Cooled

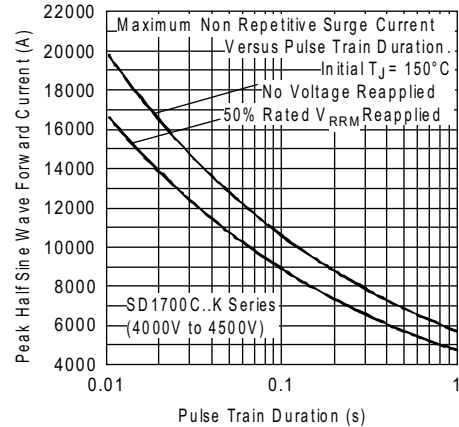

Fig. 16 - Maximum Non-Repetitive Surge Current Single and Double Side Cooled

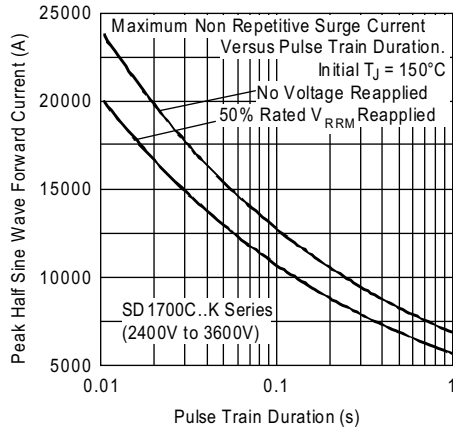

Fig. 14 - Maximum Non-Repetitive Surge Current Single and Double Side Cooled

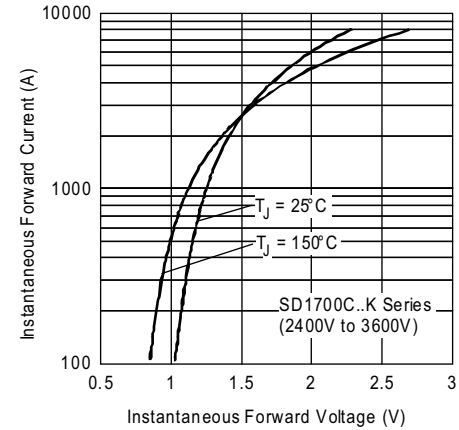

Fig. 17 - Forward Voltage Drop Characteristics

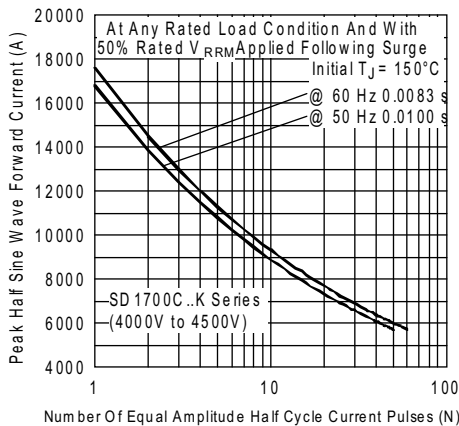

Fig. 15 - Maximum Non-Repetitive Surge Current Single and Double Side Cooled

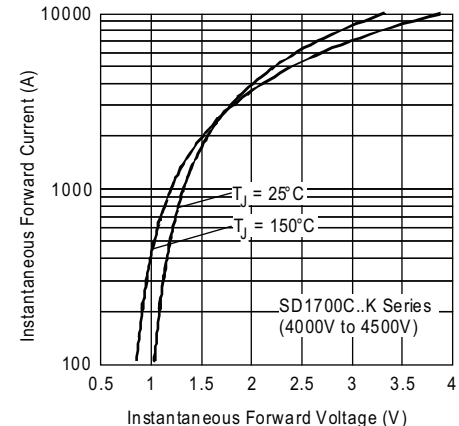

Fig. 18 - Forward Voltage Drop Characteristics

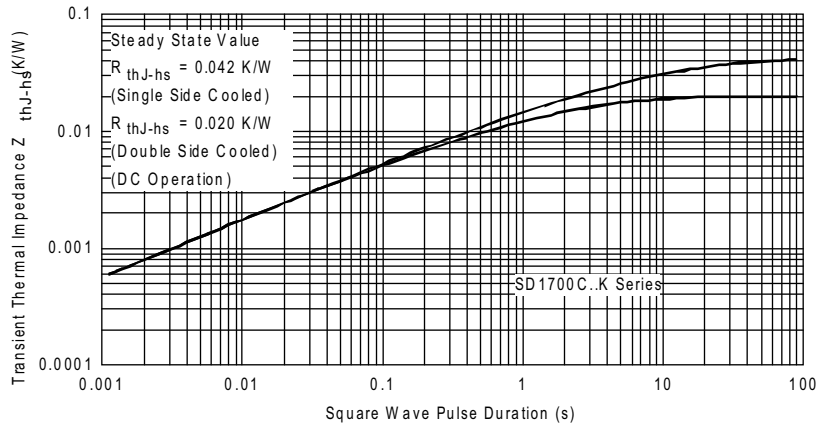

Fig. 19 - Thermal Impedance Z_{thJC} Characteristics

ORDERING INFORMATION TABLE

Device code	VS-	SD	170	0	C	45	K		
	①	②	③	④	⑤	⑥	⑦		
	1	-	Vishay Semiconductors product	2	-	Diode	3	-	Essential part number
	4	-	0 = Standard recovery	5	-	C = Ceramic PUK	6	-	Voltage code x 100 = V_{RRM} (see Voltage Ratings table)
	7	-	K = PUK case DO-200AC (K-PUK)						

LINKS TO RELATED DOCUMENTS

Dimensions	www.vishay.com/doc?95247
------------	--

DO-200AC (K-PUK)

DIMENSIONS in millimeters (inches)

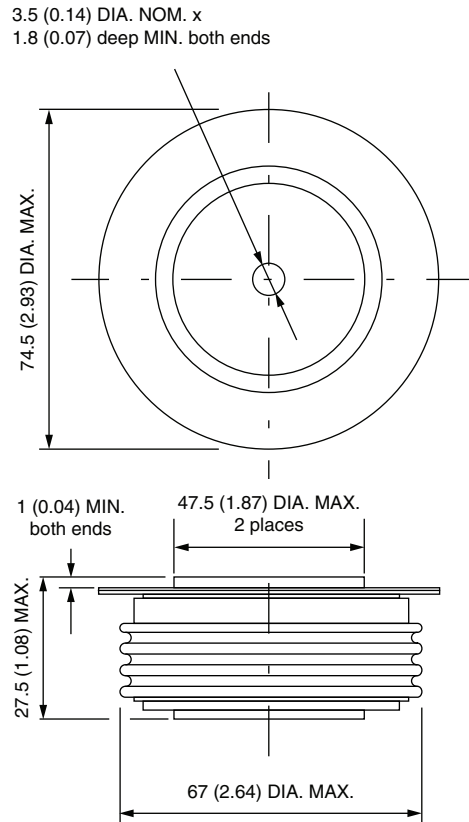

Quote between upper and lower pole pieces has to be considered after application of mounting force (see Thermal and Mechanical Specifications)



Disclaimer

ALL PRODUCT, PRODUCT SPECIFICATIONS AND DATA ARE SUBJECT TO CHANGE WITHOUT NOTICE TO IMPROVE RELIABILITY, FUNCTION OR DESIGN OR OTHERWISE.

Vishay Intertechnology, Inc., its affiliates, agents, and employees, and all persons acting on its or their behalf (collectively, "Vishay"), disclaim any and all liability for any errors, inaccuracies or incompleteness contained in any datasheet or in any other disclosure relating to any product.

Vishay makes no warranty, representation or guarantee regarding the suitability of the products for any particular purpose or the continuing production of any product. To the maximum extent permitted by applicable law, Vishay disclaims (i) any and all liability arising out of the application or use of any product, (ii) any and all liability, including without limitation special, consequential or incidental damages, and (iii) any and all implied warranties, including warranties of fitness for particular purpose, non-infringement and merchantability.

Statements regarding the suitability of products for certain types of applications are based on Vishay's knowledge of typical requirements that are often placed on Vishay products in generic applications. Such statements are not binding statements about the suitability of products for a particular application. It is the customer's responsibility to validate that a particular product with the properties described in the product specification is suitable for use in a particular application. Parameters provided in datasheets and/or specifications may vary in different applications and performance may vary over time. All operating parameters, including typical parameters, must be validated for each customer application by the customer's technical experts. Product specifications do not expand or otherwise modify Vishay's terms and conditions of purchase, including but not limited to the warranty expressed therein.

Except as expressly indicated in writing, Vishay products are not designed for use in medical, life-saving, or life-sustaining applications or for any other application in which the failure of the Vishay product could result in personal injury or death. Customers using or selling Vishay products not expressly indicated for use in such applications do so at their own risk. Please contact authorized Vishay personnel to obtain written terms and conditions regarding products designed for such applications.

No license, express or implied, by estoppel or otherwise, to any intellectual property rights is granted by this document or by any conduct of Vishay. Product names and markings noted herein may be trademarks of their respective owners.

Material Category Policy

Vishay Intertechnology, Inc. hereby certifies that all its products that are identified as RoHS-Compliant fulfill the definitions and restrictions defined under Directive 2011/65/EU of The European Parliament and of the Council of June 8, 2011 on the restriction of the use of certain hazardous substances in electrical and electronic equipment (EEE) - recast, unless otherwise specified as non-compliant.

Please note that some Vishay documentation may still make reference to RoHS Directive 2002/95/EC. We confirm that all the products identified as being compliant to Directive 2002/95/EC conform to Directive 2011/65/EU.

Vishay Intertechnology, Inc. hereby certifies that all its products that are identified as Halogen-Free follow Halogen-Free requirements as per JEDEC JS709A standards. Please note that some Vishay documentation may still make reference to the IEC 61249-2-21 definition. We confirm that all the products identified as being compliant to IEC 61249-2-21 conform to JEDEC JS709A standards.



Компания «ЭлектроПласт» предлагает заключение долгосрочных отношений при поставках импортных электронных компонентов на взаимовыгодных условиях!

Наши преимущества:

- Оперативные поставки широкого спектра электронных компонентов отечественного и импортного производства напрямую от производителей и с крупнейших мировых складов;
- Поставка более 17-ти миллионов наименований электронных компонентов;
- Поставка сложных, дефицитных, либо снятых с производства позиций;
- Оперативные сроки поставки под заказ (от 5 рабочих дней);
- Экспресс доставка в любую точку России;
- Техническая поддержка проекта, помощь в подборе аналогов, поставка прототипов;
- Система менеджмента качества сертифицирована по Международному стандарту ISO 9001;
- Лицензия ФСБ на осуществление работ с использованием сведений, составляющих государственную тайну;
- Поставка специализированных компонентов (Xilinx, Altera, Analog Devices, Intersil, Interpoint, Microsemi, Aeroflex, Peregrine, Syfer, Eurofarad, Texas Instrument, Miteq, Cobham, E2V, MA-COM, Hittite, Mini-Circuits, General Dynamics и др.);

Помимо этого, одним из направлений компании «ЭлектроПласт» является направление «Источники питания». Мы предлагаем Вам помощь Конструкторского отдела:

- Подбор оптимального решения, техническое обоснование при выборе компонента;
- Подбор аналогов;
- Консультации по применению компонента;
- Поставка образцов и прототипов;
- Техническая поддержка проекта;
- Защита от снятия компонента с производства.



Как с нами связаться

Телефон: 8 (812) 309 58 32 (многоканальный)

Факс: 8 (812) 320-02-42

Электронная почта: org@eplast1.ru

Адрес: 198099, г. Санкт-Петербург, ул. Калинина, дом 2, корпус 4, литера А.