

# Octal 12-/10-/8-Bit I<sup>2</sup>C V<sub>OUT</sub> DACs with 10ppm/°C Reference

## FEATURES

- Integrated Precision Reference:
  - 2.5V Full-Scale 10ppm/°C (LTC2637-L)
  - 4.096V Full-Scale 10ppm/°C (LTC2637-H)
- Maximum INL Error: 2.5LSB (LTC2637-12)
- Low Noise: 0.75mV<sub>P-P</sub> 0.1Hz to 200kHz
- Guaranteed Monotonic Over -40°C to 125°C Temperature Range
- Selectable Internal or External Reference
- 2.7V to 5.5V Supply Range (LTC2637-L)
- Ultralow Crosstalk Between DACs (<3nV•s)
- Low Power: 100µA per DAC at 3V (LTC2637-L)
- Power-On-Reset to Zero-Scale/Mid-Scale
- Double-Buffered Data Latches
- Tiny 14-Lead 4mm × 3mm DFN and 16-Lead MSOP Packages

## APPLICATIONS

- Mobile Communications
- Process Control and Industrial Automation
- Automatic Test Equipment
- Portable Equipment
- Automotive
- Optical Networking

## DESCRIPTION

The LTC<sup>®</sup>2637 is a family of octal 12-, 10-, and 8-bit voltage-output DACs with an integrated, high-accuracy, low-drift 10ppm/°C reference in 14-lead DFN and 16-lead MSOP packages. It has a rail-to-rail output buffer and is guaranteed monotonic. The LTC2637-L has a full-scale output of 2.5V, and operates from a single 2.7V to 5.5V supply. The LTC2637-H has a full-scale output of 4.096V, and operates from a 4.5V to 5.5V supply. Each DAC can also operate with an external reference, which sets the DAC full-scale output to the external reference voltage.

These DACs communicate via a 2-wire I<sup>2</sup>C-compatible serial interface. The LTC2637 operates in both the standard mode (clock rate of 100kHz) and the fast mode (clock rate of 400kHz). The LTC2637 incorporates a power-on reset circuit. Options are available for reset to zero-scale or reset to mid-scale in internal reference mode, or reset to mid-scale in external reference mode after power-up.

All registered trademarks and trademarks are the property of their respective owners. Protected by U.S. patents, including 5396245, 5859606, 6891433, 6937178, 7414561.

## BLOCK DIAGRAM



Integral Nonlinearity (LTC2637-LZ12)



# LTC2637

## ABSOLUTE MAXIMUM RATINGS (Notes 1, 2)

|  |  |                                      |                |
|--|--|--------------------------------------|----------------|
| Supply Voltage ( $V_{CC}$ ) .....              | -0.3V to 6V                              | LTC2637I .....                       | -40°C to 85°C  |
| SCL, SDA .....                                 | -0.3V to 6V                              | LTC2637H (Note 3) .....              | -40°C to 125°C |
| $V_{OUTA} - V_{OUTH}$ ,<br>CA0, CA1, CA2 ..... | -0.3V to $\text{Min}(V_{CC} + 0.3V, 6V)$ | Maximum Junction Temperature .....   | 150°C          |
| REF .....                                      | -0.3V to $\text{Min}(V_{CC} + 0.3V, 6V)$ | Storage Temperature Range .....      | -65°C to 150°C |
| Operating Temperature Range                    |  | Lead Temperature (Soldering, 10 sec) |                |
| LTC2637C .....                                 | 0°C to 70°C                              | MS Package .....                     | 300°C          |

## PIN CONFIGURATION



## ORDER INFORMATION <http://www.linear.com/product/LTC2637#orderinfo>

| LTC2637 | C | DE | -L | Z | 12 | #TR | PBF |   |
|---------|---|----|----|---|----|-----|-----|---|
|         |   |    |    |   |    |     |     | <b>LEAD FREE DESIGNATOR</b>   |
|         |   |    |    |   |    |     |     | <b>TAPE AND REEL</b><br>TR = 2500-Piece Tape and Reel   |
|         |   |    |    |   |    |     |     | <b>RESOLUTION</b><br>12 = 12-Bit<br>10 = 10-Bit<br>8 = 8-Bit  |
|         |   |    |    |   |    |     |     | <b>POWER-ON RESET</b><br>MI = Reset to Mid-Scale in Internal Reference Mode<br>MX = Reset to Mid-Scale in External Reference Mode<br>Z = Reset to Zero-Scale in Internal Reference Mode |
|         |   |    |    |   |    |     |     | <b>FULL-SCALE VOLTAGE, INTERNAL REFERENCE MODE</b><br>L = 2.5V<br>H = 4.096V  |
|         |   |    |    |   |    |     |     | <b>PACKAGE TYPE</b><br>DE = 14-Lead DFN<br>MS = 16-Lead MSOP  |
|         |   |    |    |   |    |     |     | <b>TEMPERATURE GRADE</b><br>C = Commercial Temperature Range (0°C to 70°C)<br>I = Industrial Temperature Range (-40°C to 85°C)<br>H = Automotive Temperature Range (-40°C to 125°C)     |
|         |   |    |    |   |    |     |     | <b>PRODUCT PART NUMBER</b>  |

Consult LTC Marketing for information on non-standard lead based finish parts.

For more information on lead free part marking, go to: <http://www.linear.com/leadfree/>

For more information on tape and reel specifications, go to: <http://www.linear.com/tapeandreel/>. Some packages are available in 500 unit reels through designated sales channels with #TRMPBF suffix.

## PRODUCT SELECTION GUIDE

| PART NUMBER   | PART MARKING* |        | V <sub>FS</sub> WITH INTERNAL REFERENCE | POWER-ON RESET TO CODE | POWER-ON REFERENCE MODE | RESOLUTION | V <sub>CC</sub> | MAXIMUM INL |
|---------------|---------------|--------|---|------------------------|-------------------------|------------|-----------------|-------------|
|               | DFN           | MSOP   |   |                        |                         |            |                 |             |
| LTC2637-LMI12 | 7LMI2         | 7LMI12 | 2.5V • (4095/4096)                      | Mid-Scale              | Internal                | 12-Bit     | 2.7V to 5.5V    | ±2.5LSB     |
| LTC2637-LMI10 | 7LMI1         | 7LMI10 | 2.5V • (1023/1024)                      | Mid-Scale              | Internal                | 10-Bit     | 2.7V to 5.5V    | ±1LSB       |
| LTC2637-LMI8  | 7LMI8         | 37LMI8 | 2.5V • (255/256)                        | Mid-Scale              | Internal                | 8-Bit      | 2.7V to 5.5V    | ±0.5LSB     |
| LTC2637-LMX12 | 7LMX2         | 7LMX12 | 2.5V • (4095/4096)                      | Mid-Scale              | External                | 12-Bit     | 2.7V to 5.5V    | ±2.5LSB     |
| LTC2637-LMX10 | 7LMX1         | 7LMX10 | 2.5V • (1023/1024)                      | Mid-Scale              | External                | 10-Bit     | 2.7V to 5.5V    | ±1LSB       |
| LTC2637-LMX8  | 7LMX8         | 37LMX8 | 2.5V • (255/256)                        | Mid-Scale              | External                | 8-Bit      | 2.7V to 5.5V    | ±0.5LSB     |
| LTC2637-LZ12  | 7LZ12         | 37LZ12 | 2.5V • (4095/4096)                      | Zero-Scale             | Internal                | 12-Bit     | 2.7V to 5.5V    | ±2.5LSB     |
| LTC2637-LZ10  | 7LZ10         | 37LZ10 | 2.5V • (1023/1024)                      | Zero-Scale             | Internal                | 10-Bit     | 2.7V to 5.5V    | ±1LSB       |
| LTC2637-LZ8   | 37LZ8         | 637LZ8 | 2.5V • (255/256)                        | Zero-Scale             | Internal                | 8-Bit      | 2.7V to 5.5V    | ±0.5LSB     |
| LTC2637-HMI12 | 7HMI2         | 7HMI12 | 4.096V • (4095/4096)                    | Mid-Scale              | Internal                | 12-Bit     | 4.5V to 5.5V    | ±2.5LSB     |
| LTC2637-HMI10 | 7HMI1         | 7HMI10 | 4.096V • (1023/1024)                    | Mid-Scale              | Internal                | 10-Bit     | 4.5V to 5.5V    | ±1LSB       |
| LTC2637-HMI8  | 7HMI8         | 37HMI8 | 4.096V • (255/256)                      | Mid-Scale              | Internal                | 8-Bit      | 4.5V to 5.5V    | ±0.5LSB     |
| LTC2637-HMX12 | 7HMX2         | 7HMX12 | 4.096V • (4095/4096)                    | Mid-Scale              | External                | 12-Bit     | 4.5V to 5.5V    | ±2.5LSB     |
| LTC2637-HMX10 | 7HMX1         | 7HMX10 | 4.096V • (1023/1024)                    | Mid-Scale              | External                | 10-Bit     | 4.5V to 5.5V    | ±1LSB       |
| LTC2637-HMX8  | 7HMX8         | 37HMX8 | 4.096V • (255/256)                      | Mid-Scale              | External                | 8-Bit      | 4.5V to 5.5V    | ±0.5LSB     |
| LTC2637-HZ12  | 7HZ12         | 37HZ12 | 4.096V • (4095/4096)                    | Zero-Scale             | Internal                | 12-Bit     | 4.5V to 5.5V    | ±2.5LSB     |
| LTC2637-HZ10  | 7HZ10         | 37HZ10 | 4.096V • (1023/1024)                    | Zero-Scale             | Internal                | 10-Bit     | 4.5V to 5.5V    | ±1LSB       |
| LTC2637-HZ8   | 37HZ8         | 637HZ8 | 4.096V • (255/256)                      | Zero-Scale             | Internal                | 8-Bit      | 4.5V to 5.5V    | ±0.5LSB     |

\*Above options are available in a 14-lead DFN package (LTC2637xDE) or 16-lead MSOP package (LTC2637xMS).

## ELECTRICAL CHARACTERISTICS

The ● denotes the specifications which apply over the full operating temperature range, otherwise specifications are at  $T_A = 25^\circ\text{C}$ .  $V_{CC} = 2.7\text{V}$  to  $5.5\text{V}$ ,  $V_{OUT}$  unloaded unless otherwise specified.

LTC2637-LMI12/ LTC2637-LMI10/ LTC2637-LMI8/ LTC2637-LMX12/ LTC2637-LMX10/ LTC2637-LMX8/ LTC2637-LZ12/  
LTC2637-LZ10/ LTC2637-LZ8 ( $V_{FS} = 2.5\text{V}$ )

| SYMBOL     | PARAMETER                        | CONDITIONS  | LTC2637-8 |                |           | LTC2637-10     |           |                | LTC2637-12 |   |                              | UNITS |
|------------|----------------------------------|---|-----------|----------------|-----------|----------------|-----------|----------------|------------|---|------------------------------|-------|
|            |                                  |   | MIN       | TYP            | MAX       | MIN            | TYP       | MAX            | MIN        | TYP   | MAX                          |       |
|            | Resolution                       |   | ●         | 8              |           | 10             |           | 12             |            |   | Bits                         |       |
|            | Monotonicity                     | $V_{CC} = 3\text{V}$ , Internal Reference (Note 4)  | ●         | 8              |           | 10             |           | 12             |            |   | Bits                         |       |
| DNL        | Differential Nonlinearity        | $V_{CC} = 3\text{V}$ , Internal Reference (Note 4)  | ●         |                | $\pm 0.5$ |                | $\pm 0.5$ |                | $\pm 1$    |   | LSB                          |       |
| INL        | Integral Nonlinearity            | $V_{CC} = 3\text{V}$ , Internal Reference (Note 4)  | ●         | $\pm 0.05$     | $\pm 0.5$ | $\pm 0.2$      | $\pm 1$   | $\pm 1$        | $\pm 2.5$  |   | LSB                          |       |
| ZSE        | Zero-Scale Error                 | $V_{CC} = 3\text{V}$ , Internal Reference, Code = 0   | ●         | 0.5            | 5         | 0.5            | 5         | 0.5            | 5          |   | mV                           |       |
| $V_{OS}$   | Offset Error                     | $V_{CC} = 3\text{V}$ , Internal Reference (Note 5)  | ●         | $\pm 0.5$      | $\pm 5$   | $\pm 0.5$      | $\pm 5$   | $\pm 0.5$      | $\pm 5$    |   | mV                           |       |
| $V_{OSTC}$ | $V_{OS}$ Temperature Coefficient | $V_{CC} = 3\text{V}$ , Internal Reference   |           | $\pm 10$       |           | $\pm 10$       |           | $\pm 10$       |            |   | $\mu\text{V}/^\circ\text{C}$ |       |
| GE         | Gain Error                       | $V_{CC} = 3\text{V}$ , Internal Reference   | ●         | $\pm 0.2$      | $\pm 0.8$ | $\pm 0.2$      | $\pm 0.8$ | $\pm 0.2$      | $\pm 0.8$  |   | %FSR                         |       |
| $GE_{TC}$  | Gain Temperature Coefficient     | $V_{CC} = 3\text{V}$ , Internal Reference (Note 10)<br>C-Grade<br>I-Grade<br>H-Grade                            |           | 10<br>10<br>10 |           | 10<br>10<br>10 |           | 10<br>10<br>10 |            | ppm/ $^\circ\text{C}$<br>ppm/ $^\circ\text{C}$<br>ppm/ $^\circ\text{C}$ |                              |       |
|            | Load Regulation                  | Internal Reference, Mid-Scale,<br>$V_{CC} = 3\text{V} \pm 10\%$ ,<br>$-5\text{mA} \leq I_{OUT} \leq 5\text{mA}$ | ●         | 0.009          | 0.016     | 0.035          | 0.064     | 0.14           | 0.256      |   | LSB/<br>mA                   |       |
|            |                                  | $V_{CC} = 5\text{V} \pm 10\%$ , (Note 15)<br>$-10\text{mA} \leq I_{OUT} \leq 10\text{mA}$                       | ●         | 0.009          | 0.016     | 0.035          | 0.064     | 0.14           | 0.256      |   | LSB/<br>mA                   |       |
| $R_{OUT}$  | DC Output Impedance              | Internal Reference, Mid-Scale,<br>$V_{CC} = 3\text{V} \pm 10\%$ ,<br>$-5\text{mA} \leq I_{OUT} \leq 5\text{mA}$ | ●         | 0.09           | 0.156     | 0.09           | 0.156     | 0.09           | 0.156      |   | $\Omega$                     |       |
|            |                                  | $V_{CC} = 5\text{V} \pm 10\%$ , (Note 15)<br>$-10\text{mA} \leq I_{OUT} \leq 10\text{mA}$                       | ●         | 0.09           | 0.156     | 0.09           | 0.156     | 0.09           | 0.156      |   | $\Omega$                     |       |

| SYMBOL    | PARAMETER  | CONDITIONS   | MIN    | TYP                        | MAX       | UNITS    |
|-----------|--|--|--------|----------------------------|-----------|----------|
| $V_{OUT}$ | DAC Output Span  | External Reference<br>Internal Reference   |        | 0 to $V_{REF}$<br>0 to 2.5 |           | V<br>V   |
| PSR       | Power Supply Rejection                                       | $V_{CC} = 3\text{V} \pm 10\%$ or $5\text{V} \pm 10\%$  |        | -80                        |           | dB       |
| $I_{SC}$  | Short Circuit Output Current (Note 6)<br>Sinking<br>Sourcing | $V_{FS} = V_{CC} = 5.5\text{V}$<br>Zero-Scale; $V_{OUT}$ shorted to $V_{CC}$<br>Full-Scale; $V_{OUT}$ shorted to GND | ●<br>● | 27<br>-28                  | 48<br>-48 | mA<br>mA |

### Power Supply

| SYMBOL   | PARAMETER                                  | CONDITIONS  | MIN | TYP | MAX | UNITS         |
|----------|--|---|-----|-----|-----|---------------|
| $V_{CC}$ | Positive Supply Voltage                    | For Specified Performance   | ●   | 2.7 | 5.5 | V             |
| $I_{CC}$ | Supply Current (Note 7)                    | $V_{CC} = 3\text{V}$ , $V_{REF} = 2.5\text{V}$ , External Reference | ●   | 0.8 | 1.1 | mA            |
|          |  | $V_{CC} = 3\text{V}$ , Internal Reference                           | ●   | 0.9 | 1.3 | mA            |
|          |  | $V_{CC} = 5\text{V}$ , $V_{REF} = 2.5\text{V}$ , External Reference | ●   | 0.9 | 1.3 | mA            |
|          |  | $V_{CC} = 5\text{V}$ , Internal Reference                           | ●   | 1   | 1.5 | mA            |
| $I_{SD}$ | Supply Current in Power-Down Mode (Note 7) | $V_{CC} = 5\text{V}$ , C-Grade, I-Grade                             | ●   | 1   | 20  | $\mu\text{A}$ |
|          |  | $V_{CC} = 5\text{V}$ , H-Grade                                      | ●   | 1   | 30  | $\mu\text{A}$ |

## ELECTRICAL CHARACTERISTICS

The ● denotes the specifications which apply over the full operating temperature range, otherwise specifications are at  $T_A = 25^\circ\text{C}$ .  $V_{CC} = 2.7\text{V}$  to  $5.5\text{V}$ ,  $V_{OUT}$  unloaded unless otherwise specified.

LTC2637-LMI12/ LTC2637-LMI10/ LTC2637-LMI8/ LTC2637-LMX12/ LTC2637-LMX10/ LTC2637-LMX8/ LTC2637-LZ12/  
LTC2637-LZ10/ LTC2637-LZ8 ( $V_{FS} = 2.5\text{V}$ )

| SYMBOL                  | PARAMETER   | CONDITIONS  | MIN | TYP           | MAX          | UNITS                 |           |
|-------------------------|---|---|-----|---------------|--------------|-----------------------|-----------|
| <b>Reference Input</b>  |   |   |     |               |              |                       |           |
|                         | Input Voltage Range   |   | ●   | 1             | $V_{CC}$     | V                     |           |
|                         | Resistance  |   | ●   | 120           | 160          | 200                   | $k\Omega$ |
|                         | Capacitance   |   |     | 12            |              | pF                    |           |
| $I_{REF}$               | Reference Current, Power-Down Mode  | DAC Powered Down  | ●   | 0.005         | 1.5          | $\mu\text{A}$         |           |
| <b>Reference Output</b> |   |   |     |               |              |                       |           |
|                         | Output Voltage  |   | ●   | 1.24          | 1.25         | 1.26                  | V         |
|                         | Reference Temperature Coefficient   |   |     | $\pm 10$      |              | ppm/ $^\circ\text{C}$ |           |
|                         | Output Impedance  |   |     | 0.5           |              | $k\Omega$             |           |
|                         | Capacitive Load Driving   |   |     | 10            |              | $\mu\text{F}$         |           |
|                         | Short Circuit Current   | $V_{CC} = 5.5\text{V}$ ; REF Shorted to GND   |     | 2.5           |              | mA                    |           |
| <b>Digital I/O</b>      |   |   |     |               |              |                       |           |
| $V_{IL}$                | Low Level Input Voltage (SDA and SCL)   | (Note 14)   | ●   | -0.5          | $0.3V_{CC}$  | V                     |           |
| $V_{IH}$                | High Level Input Voltage (SDA and SCL)  | (Note 11)   | ●   | $0.7V_{CC}$   |              | V                     |           |
| $V_{IL(CAn)}$           | Low Level Input Voltage on $CA_n$<br>( $n = 0, 1, 2$ )                                    | See Test Circuit 1  | ●   |               | $0.15V_{CC}$ | V                     |           |
| $V_{IH(CAn)}$           | High Level Input Voltage on $CA_n$<br>( $n = 0, 1, 2$ )                                   | See Test Circuit 1  | ●   | $0.85V_{CC}$  |              | V                     |           |
| $R_{INH}$               | Resistance from $CA_n$ ( $n=0, 1, 2$ )<br>to $V_{CC}$ to Set $CA_n = V_{CC}$              | See Test Circuit 2  | ●   |               | 10           | $k\Omega$             |           |
| $R_{INL}$               | Resistance from $CA_n$ ( $n=0, 1, 2$ )<br>to GND to Set $CA_n = \text{GND}$               | See Test Circuit 2  | ●   |               | 10           | $k\Omega$             |           |
| $R_{INF}$               | Resistance from $CA_n$ ( $n=0, 1, 2$ )<br>to $V_{CC}$ or GND to Set $CA_n = \text{Float}$ | See Test Circuit 2  | ●   | 2             |              | $M\Omega$             |           |
| $V_{OL}$                | Low Level Output Voltage  | Sink Current = 3mA  | ●   | 0             | 0.4          | V                     |           |
| $t_{OF}$                | Output Fall Time  | $V_O = V_{IH(MIN)}$ to $V_O = V_{IL(MAX)}$ ,<br>$C_B = 10\text{pF}$ to $400\text{pF}$ (Note 12) | ●   | $20 + 0.1C_B$ | 250          | ns                    |           |
| $t_{SP}$                | Pulse Width of Spikes Suppressed<br>by Input Filter                                       |   | ●   | 0             | 50           | ns                    |           |
| $I_{IN}$                | Input Leakage   | $0.1V_{CC} \leq V_{IN} \leq 0.9V_{CC}$  | ●   |               | $\pm 1$      | $\mu\text{A}$         |           |
| $C_{IN}$                | I/O Pin Capacitance   | (Note 8)  | ●   |               | 10           | pF                    |           |
| $C_B$                   | Capacitive Load for Each Bus Line   |   | ●   |               | 400          | pF                    |           |
| $C_{CA_n}$              | External Capacitive Load on Address<br>Pin $CA_n$ ( $n=0, 1, 2$ )                         |   | ●   |               | 10           | pF                    |           |

## ELECTRICAL CHARACTERISTICS

The ● denotes the specifications which apply over the full operating temperature range, otherwise specifications are at  $T_A = 25^\circ\text{C}$ .  $V_{CC} = 2.7\text{V}$  to  $5.5\text{V}$ ,  $V_{OUT}$  unloaded unless otherwise specified.

LTC2637-LMI12/ LTC2637-LMI10/ LTC2637-LMI8/ LTC2637-LMX12/ LTC2637-LMX10/ LTC2637-LMX8/ LTC2637-LZ12/  
LTC2637-LZ10/ LTC2637-LZ8 ( $V_{FS} = 2.5\text{V}$ )

| SYMBOL                | PARAMETER                    | CONDITIONS   | MIN | TYP | MAX | UNITS                        |
|-----------------------|------------------------------|--|-----|-----|-----|------------------------------|
| <b>AC Performance</b> |                              |  |     |     |     |                              |
| $t_S$                 | Settling Time                | $V_{CC} = 3\text{V}$ (Note 9)<br>$\pm 0.39\%$ ( $\pm 1\text{LSB}$ at 8 Bits)<br>$\pm 0.098\%$ ( $\pm 1\text{LSB}$ at 10 Bits)<br>$\pm 0.024\%$ ( $\pm 1\text{LSB}$ at 12 Bits)     |     | 3.5 |     | $\mu\text{s}$                |
|                       |                              |  |     | 4.1 |     | $\mu\text{s}$                |
|                       |                              |  |     | 4.5 |     | $\mu\text{s}$                |
|                       | Voltage Output Slew Rate     |  |     | 1.0 |     | $\text{V}/\mu\text{s}$       |
|                       | Capacitive Load Driving      |  |     | 500 |     | $\text{pF}$                  |
|                       | Glitch Impulse               | At Mid-Scale Transition  |     | 2.1 |     | $\text{nV}\cdot\text{s}$     |
|                       | DAC-to-DAC Crosstalk         | 1 DAC held at FS, 1 DAC Switched 0 to FS   |     | 2.6 |     | $\text{nV}\cdot\text{s}$     |
|                       | Multiplying Bandwidth        | External Reference   |     | 320 |     | $\text{kHz}$                 |
| $e_n$                 | Output Voltage Noise Density | At $f = 1\text{kHz}$ , External Reference<br>At $f = 10\text{kHz}$ , External Reference<br>At $f = 1\text{kHz}$ , Internal Reference<br>At $f = 10\text{kHz}$ , Internal Reference |     | 180 |     | $\text{nV}/\sqrt{\text{Hz}}$ |
|                       |                              |  |     | 160 |     | $\text{nV}/\sqrt{\text{Hz}}$ |
|                       |                              |  |     | 200 |     | $\text{nV}/\sqrt{\text{Hz}}$ |
|                       |                              |  |     | 180 |     | $\text{nV}/\sqrt{\text{Hz}}$ |
|                       | Output Voltage Noise         | 0.1Hz to 10Hz, External Reference<br>0.1Hz to 10Hz, Internal Reference<br>0.1Hz to 200kHz, External Reference<br>0.1Hz to 200kHz, Internal Reference                               |     | 35  |     | $\mu\text{V}_{\text{P-P}}$   |
|                       |                              |  |     | 40  |     | $\mu\text{V}_{\text{P-P}}$   |
|                       |                              |  |     | 680 |     | $\mu\text{V}_{\text{P-P}}$   |
|                       |                              |  |     | 730 |     | $\mu\text{V}_{\text{P-P}}$   |

## TIMING CHARACTERISTICS

The ● denotes the specifications which apply over the full operating temperature range, otherwise specifications are at  $T_A = 25^\circ\text{C}$ .  $V_{CC} = 2.7\text{V}$  to  $5.5\text{V}$ . (See Figure 1) (Note 13)

LTC2637-LMI12/ LTC2637-LMI10/ LTC2637-LMI8/ LTC2637-LMX12/ LTC2637-LMX10/ LTC2637-LMX8/ LTC2637-LZ12/  
LTC2637-LZ10/ LTC2637-LZ8 ( $V_{FS} = 2.5\text{V}$ )

| SYMBOL               | PARAMETER  | CONDITIONS | MIN | TYP           | MAX | UNITS         |
|----------------------|--|------------|-----|---------------|-----|---------------|
| $f_{\text{SCL}}$     | SCL Clock Frequency                              |            | ●   | 0             | 400 | $\text{kHz}$  |
| $t_{\text{HD(STA)}}$ | Hold Time (Repeated) Start Condition             |            | ●   | 0.6           |     | $\mu\text{s}$ |
| $t_{\text{LOW}}$     | Low Period of the SCL Clock Pin                  |            | ●   | 1.3           |     | $\mu\text{s}$ |
| $t_{\text{HIGH}}$    | High Period of the SCL Clock Pin                 |            | ●   | 0.6           |     | $\mu\text{s}$ |
| $t_{\text{SU(STA)}}$ | Set-Up Time for a Repeated Start Condition       |            | ●   | 0.6           |     | $\mu\text{s}$ |
| $t_{\text{HD(DAT)}}$ | Data Hold Time                                   |            | ●   | 0             | 0.9 | $\mu\text{s}$ |
| $t_{\text{SU(DAT)}}$ | Data Set-Up Time                                 |            | ●   | 100           |     | $\text{ns}$   |
| $t_r$                | Rise Time of Both SDA and SCL Signals            | (Note 12)  | ●   | $20 + 0.1C_B$ | 300 | $\text{ns}$   |
| $t_f$                | Fall Time of Both SDA and SCL Signals            | (Note 12)  | ●   | $20 + 0.1C_B$ | 300 | $\text{ns}$   |
| $t_{\text{SU(STO)}}$ | Set-Up Time for Stop Condition                   |            | ●   | 0.6           |     | $\mu\text{s}$ |
| $t_{\text{BUF}}$     | Bus Free Time Between a Stop and Start Condition |            | ●   | 1.3           |     | $\mu\text{s}$ |

## ELECTRICAL CHARACTERISTICS

The ● denotes the specifications which apply over the full operating temperature range, otherwise specifications are at  $T_A = 25^\circ\text{C}$ .  $V_{CC} = 4.5\text{V}$  to  $5.5\text{V}$ ,  $V_{OUT}$  unloaded unless otherwise specified.

LTC2637-HMI12/ LTC2637-HMI10/ LTC2637-HMI8/ LTC2637-HMX12/ LTC2637-HMX10/ LTC2637-HMX8/ LTC2637-HZ12/  
LTC2637-HZ10/ LTC2637-HZ8 ( $V_{FS} = 4.096\text{V}$ )

| SYMBOL     | PARAMETER                        | CONDITIONS  | LTC2637-8 |                |           | LTC2637-10     |           |                | LTC2637-12 |     |   | UNITS |
|------------|----------------------------------|---|-----------|----------------|-----------|----------------|-----------|----------------|------------|-----|---|-------|
|            |                                  |   | MIN       | TYP            | MAX       | MIN            | TYP       | MAX            | MIN        | TYP | MAX   |       |
|            | Resolution                       |   | ●         | 8              |           | 10             |           | 12             |            |     | Bits  |       |
|            | Monotonicity                     | $V_{CC} = 5\text{V}$ , Internal Reference (Note 4)  | ●         | 8              |           | 10             |           | 12             |            |     | Bits  |       |
| DNL        | Differential Nonlinearity        | $V_{CC} = 5\text{V}$ , Internal Reference (Note 4)  | ●         |                | $\pm 0.5$ |                | $\pm 0.5$ |                | $\pm 1$    |     | LSB   |       |
| INL        | Integral Nonlinearity            | $V_{CC} = 5\text{V}$ , Internal Reference (Note 4)  | ●         | $\pm 0.05$     | $\pm 0.5$ | $\pm 0.2$      | $\pm 1$   | $\pm 1$        | $\pm 2.5$  |     | LSB   |       |
| ZSE        | Zero-Scale Error                 | $V_{CC} = 5\text{V}$ , Internal Reference, Code = 0   | ●         | 0.5            | 5         | 0.5            | 5         | 0.5            | 5          |     | mV  |       |
| $V_{OS}$   | Offset Error                     | $V_{CC} = 5\text{V}$ , Internal Reference (Note 5)  | ●         | $\pm 0.5$      | $\pm 5$   | $\pm 0.5$      | $\pm 5$   | $\pm 0.5$      | $\pm 5$    |     | mV  |       |
| $V_{OSTC}$ | $V_{OS}$ Temperature Coefficient | $V_{CC} = 5\text{V}$ , Internal Reference   |           | $\pm 10$       |           | $\pm 10$       |           | $\pm 10$       |            |     | $\mu\text{V}/^\circ\text{C}$  |       |
| GE         | Gain Error                       | $V_{CC} = 5\text{V}$ , Internal Reference   | ●         | $\pm 0.2$      | $\pm 0.8$ | $\pm 0.2$      | $\pm 0.8$ | $\pm 0.2$      | $\pm 0.8$  |     | %FSR  |       |
| $GE_{TC}$  | Gain Temperature Coefficient     | $V_{CC} = 5\text{V}$ , Internal Reference (Note 10)<br>C-Grade<br>I-Grade<br>H-Grade  |           | 10<br>10<br>10 |           | 10<br>10<br>10 |           | 10<br>10<br>10 |            |     | ppm/ $^\circ\text{C}$<br>ppm/ $^\circ\text{C}$<br>ppm/ $^\circ\text{C}$ |       |
|            | Load Regulation                  | $V_{CC} = 5\text{V} \pm 10\%$ , (Note 15)<br>Internal Reference, Mid-Scale,<br>$-10\text{mA} \leq I_{OUT} \leq 10\text{mA}$ | ●         | 0.006          | 0.01      | 0.022          | 0.04      | 0.09           | 0.16       |     | LSB/mA  |       |
| $R_{OUT}$  | DC Output Impedance              | $V_{CC} = 5\text{V} \pm 10\%$ , (Note 15)<br>Internal Reference, Mid-Scale,<br>$-10\text{mA} \leq I_{OUT} \leq 10\text{mA}$ | ●         | 0.09           | 0.156     | 0.09           | 0.156     | 0.09           | 0.156      |     | $\Omega$  |       |

| SYMBOL    | PARAMETER  | CONDITIONS   | MIN    | TYP                          | MAX       | UNITS    |
|-----------|--|--|--------|------------------------------|-----------|----------|
| $V_{OUT}$ | DAC Output Span  | External Reference<br>Internal Reference   |        | 0 to $V_{REF}$<br>0 to 4.096 |           | V<br>V   |
| PSR       | Power Supply Rejection                                       | $V_{CC} = 5\text{V} \pm 10\%$  |        | -80                          |           | dB       |
| $I_{SC}$  | Short Circuit Output Current (Note 6)<br>Sinking<br>Sourcing | $V_{FS} = V_{CC} = 5.5\text{V}$<br>Zero-Scale; $V_{OUT}$ Shorted to $V_{CC}$<br>Full-Scale; $V_{OUT}$ Shorted to GND | ●<br>● | 27<br>-28                    | 48<br>-48 | mA<br>mA |

### Power Supply

|          |  |  |        |            |            |                                |
|----------|--|--|--------|------------|------------|--------------------------------|
| $V_{CC}$ | Positive Supply Voltage                    | For Specified Performance  | ●      | 4.5        | 5.5        | V                              |
| $I_{CC}$ | Supply Current (Note 7)                    | $V_{CC} = 5\text{V}$ , $V_{REF} = 4.096\text{V}$ , External Reference<br>$V_{CC} = 5\text{V}$ , Internal Reference | ●<br>● | 1.0<br>1.1 | 1.3<br>1.5 | mA<br>mA                       |
| $I_{SD}$ | Supply Current in Power-Down Mode (Note 7) | $V_{CC} = 5\text{V}$ , C-Grade, I-Grade<br>$V_{CC} = 5\text{V}$ , H-Grade  | ●<br>● | 1<br>1     | 20<br>30   | $\mu\text{A}$<br>$\mu\text{A}$ |

### Reference Input

|           |                                    |                  |   |       |          |               |            |
|-----------|------------------------------------|------------------|---|-------|----------|---------------|------------|
|           | Input Voltage Range                |                  | ● | 1     | $V_{CC}$ | V             |            |
|           | Resistance                         |                  | ● | 120   | 160      | 200           | k $\Omega$ |
|           | Capacitance                        |                  |   | 12    |          |               | pF         |
| $I_{REF}$ | Reference Current, Power-Down Mode | DAC Powered Down | ● | 0.005 | 1.5      | $\mu\text{A}$ |            |

### Reference Output

|  |                                   |  |   |          |       |       |                       |
|--|-----------------------------------|--|---|----------|-------|-------|-----------------------|
|  | Output Voltage                    |  | ● | 2.032    | 2.048 | 2.064 | V                     |
|  | Reference Temperature Coefficient |  |   | $\pm 10$ |       |       | ppm/ $^\circ\text{C}$ |



## ELECTRICAL CHARACTERISTICS

The ● denotes the specifications which apply over the full operating temperature range, otherwise specifications are at  $T_A = 25^\circ\text{C}$ .  $V_{CC} = 4.5\text{V}$  to  $5.5\text{V}$ ,  $V_{OUT}$  unloaded unless otherwise specified.

LTC2637-HMI12/ LTC2637-HMI10/ LTC2637-HMI8/ LTC2637-HMX12/ LTC2637-HMX10/ LTC2637-HMX8/ LTC2637-HZ12/  
LTC2637-HZ10/ LTC2637-HZ8 ( $V_{FS} = 4.096\text{V}$ )

| SYMBOL | PARAMETER               | CONDITIONS                                  | MIN | TYP | MAX | UNITS         |
|--------|-------------------------|---|-----|-----|-----|---------------|
|        | Output Impedance        |   |     | 0.5 |     | k $\Omega$    |
|        | Capacitive Load Driving |   |     | 10  |     | $\mu\text{F}$ |
|        | Short Circuit Current   | $V_{CC} = 5.5\text{V}$ ; REF Shorted to GND |     | 4   |     | mA            |

### Digital I/O

|                |  |   |   |               |              |               |
|----------------|--|---|---|---------------|--------------|---------------|
| $V_{IL}$       | Low Level Input Voltage (SDA and SCL)  | (Note 14)   | ● | -0.5          | $0.3V_{CC}$  | V             |
| $V_{IH}$       | High Level Input Voltage (SDA and SCL)   | (Note 11)   | ● | $0.7V_{CC}$   |              | V             |
| $V_{IL(CA_n)}$ | Low Level Input Voltage on $CA_n$<br>( $n = 0, 1, 2$ )                                   | See Test Circuit 1  | ● |               | $0.15V_{CC}$ | V             |
| $V_{IH(CA_n)}$ | High Level Input Voltage on $CA_n$<br>( $n = 0, 1, 2$ )                                  | See Test Circuit 1  | ● | $0.85V_{CC}$  |              | V             |
| $R_{INH}$      | Resistance from $CA_n$ ( $n=0, 1,2$ )<br>to $V_{CC}$ to Set $CA_n = V_{CC}$              | See Test Circuit 2  | ● |               | 10           | k $\Omega$    |
| $R_{INL}$      | Resistance from $CA_n$ ( $n=0, 1,2$ )<br>to GND to Set $CA_n = \text{GND}$               | See Test Circuit 2  | ● |               | 10           | k $\Omega$    |
| $R_{INF}$      | Resistance from $CA_n$ ( $n=0, 1,2$ )<br>to $V_{CC}$ or GND to Set $CA_n = \text{Float}$ | See Test Circuit 2  | ● | 2             |              | M $\Omega$    |
| $V_{OL}$       | Low Level Output Voltage   | Sink Current = 3mA  | ● | 0             | 0.4          | V             |
| $t_{OF}$       | Output Fall Time   | $V_O = V_{IH(MIN)}$ to $V_O = V_{IL(MAX)}$ ,<br>$C_B = 10\text{pF}$ to $400\text{pF}$ (Note 12) | ● | $20 + 0.1C_B$ | 250          | ns            |
| $t_{SP}$       | Pulse Width of Spikes Suppressed<br>by Input Filter                                      |   | ● | 0             | 50           | ns            |
| $I_{IN}$       | Input Leakage  | $0.1V_{CC} \leq V_{IN} \leq 0.9V_{CC}$  | ● |               | $\pm 1$      | $\mu\text{A}$ |
| $C_{IN}$       | I/O Pin Capacitance  | (Note 8)  | ● |               | 10           | pF            |
| $C_B$          | Capacitive Load for Each Bus Line  |   | ● |               | 400          | pF            |
| $C_{CA_n}$     | External Capacitive Load on Address<br>Pin $CA_n$ ( $n=0, 1,2$ )                         |   | ● |               | 10           | pF            |

### AC Performance

|       |                              |  |  |  |                          |  |
|-------|------------------------------|--|--|--|--------------------------|--|
| $t_S$ | Settling Time                | $V_{CC} = 3\text{V}$ (Note 9)<br>$\pm 0.39\%$ ( $\pm 1\text{LSB}$ at 8 Bits)<br>$\pm 0.098\%$ ( $\pm 1\text{LSB}$ at 10 Bits)<br>$\pm 0.024\%$ ( $\pm 1\text{LSB}$ at 12 Bits)     |  |  | 3.9<br>4.3<br>5          | $\mu\text{s}$<br>$\mu\text{s}$<br>$\mu\text{s}$  |
|       | Voltage Output Slew Rate     |  |  |  | 1                        | V/ $\mu\text{s}$   |
|       | Capacitive Load Driving      |  |  |  | 500                      | pF   |
|       | Glitch Impulse               | At Mid-Scale Transition  |  |  | 3                        | nV $\cdot\text{s}$   |
|       | DAC-to-DAC Crosstalk         | 1 DAC held at FS, 1 DAC Switched 0 to FS   |  |  | 3                        | nV $\cdot\text{s}$   |
|       | Multiplying Bandwidth        | External Reference   |  |  | 320                      | kHz  |
| $e_n$ | Output Voltage Noise Density | At $f = 1\text{kHz}$ , External Reference<br>At $f = 10\text{kHz}$ , External Reference<br>At $f = 1\text{kHz}$ , Internal Reference<br>At $f = 10\text{kHz}$ , Internal Reference |  |  | 180<br>160<br>250<br>230 | nV/ $\sqrt{\text{Hz}}$<br>nV/ $\sqrt{\text{Hz}}$<br>nV/ $\sqrt{\text{Hz}}$<br>nV/ $\sqrt{\text{Hz}}$ |
|       | Output Voltage Noise         | 0.1Hz to 10Hz, External Reference<br>0.1Hz to 10Hz, Internal Reference<br>0.1Hz to 200kHz, External Reference<br>0.1Hz to 200kHz, Internal Reference                               |  |  | 35<br>50<br>680<br>750   | $\mu\text{V}_{P-P}$<br>$\mu\text{V}_{P-P}$<br>$\mu\text{V}_{P-P}$<br>$\mu\text{V}_{P-P}$             |

## TIMING CHARACTERISTICS

The ● denotes specifications that apply over the full operating temperature range, otherwise specifications are at  $T_A = 25^\circ\text{C}$ .  $V_{CC} = 4.5\text{V}$  to  $5.5\text{V}$ . (See Figure 1) (Note 13).

LTC2637-HMI12/ LTC2637-HMI10/ LTC2637-HMI8/ LTC2637-HMX12/ LTC2637-HMX10/ LTC2637-HMX8/ LTC2637-HZ12/  
LTC2637-HZ10/ LTC2637-HZ8 ( $V_{FS} = 4.096\text{V}$ )

| SYMBOL               | PARAMETER  | CONDITIONS | MIN | TYP           | MAX | UNITS         |
|----------------------|--|------------|-----|---------------|-----|---------------|
| $f_{\text{SCL}}$     | SCL Clock Frequency                              |            | ●   | 0             | 400 | kHz           |
| $t_{\text{HD(STA)}}$ | Hold Time (Repeated) Start Condition             |            | ●   | 0.6           |     | $\mu\text{s}$ |
| $t_{\text{LOW}}$     | Low Period of the SCL Clock Pin                  |            | ●   | 1.3           |     | $\mu\text{s}$ |
| $t_{\text{HIGH}}$    | High Period of the SCL Clock Pin                 |            | ●   | 0.6           |     | $\mu\text{s}$ |
| $t_{\text{SU(STA)}}$ | Set-Up Time for a Repeated Start Condition       |            | ●   | 0.6           |     | $\mu\text{s}$ |
| $t_{\text{HD(DAT)}}$ | Data Hold Time                                   |            | ●   | 0             | 0.9 | $\mu\text{s}$ |
| $t_{\text{SU(DAT)}}$ | Data Set-Up Time                                 |            | ●   | 100           |     | ns            |
| $t_r$                | Rise Time of Both SDA and SCL Signals            | (Note 12)  | ●   | $20 + 0.1C_B$ | 300 | ns            |
| $t_f$                | Fall Time of Both SDA and SCL Signals            | (Note 12)  | ●   | $20 + 0.1C_B$ | 300 | ns            |
| $t_{\text{SU(STO)}}$ | Set-Up Time for Stop Condition                   |            | ●   | 0.6           |     | $\mu\text{s}$ |
| $t_{\text{BUF}}$     | Bus Free Time Between a Stop and Start Condition |            | ●   | 1.3           |     | $\mu\text{s}$ |

**Note 1:** Stresses beyond those listed under Absolute Maximum Ratings may cause permanent damage to the device. Exposure to any Absolute Maximum Rating condition for extended periods may affect device reliability and lifetime.

**Note 2:** All voltages are with respect to GND.

**Note 3:** Operating at temperatures above  $90^\circ\text{C}$  and with  $V_{CC} > 4\text{V}$  requires  $V_{CC}$  slew rates to be no greater than  $110\text{mV}/\mu\text{s}$ .

**Note 4:** Linearity and monotonicity are defined from code  $k_L$  to code  $2^N - 1$ , where  $N$  is the resolution and  $k_L$  is given by  $k_L = 0.016 \cdot (2^N / V_{FS})$ , rounded to the nearest whole code. For  $V_{FS} = 2.5\text{V}$  and  $N = 12$ ,  $k_L = 26$  and linearity is defined from code 26 to code 4,095. For  $V_{FS} = 4.096\text{V}$  and  $N = 12$ ,  $k_L = 16$  and linearity is defined from code 16 to code 4,095.

**Note 5:** Inferred from measurement at code 16 (LTC2637-12), code 4 (LTC2637-10) or code 1 (LTC2637-8), and at full-scale.

**Note 6:** This IC includes current limiting that is intended to protect the device during momentary overload conditions. Junction temperature can exceed the rated maximum during current limiting. Continuous operation above the specified maximum operating junction temperature may impair device reliability.

**Note 7:** Digital inputs at  $0\text{V}$  or  $V_{CC}$ .

**Note 8:** Guaranteed by design and not production tested.

**Note 9:** Internal Reference mode. DAC is stepped 1/4 scale to 3/4 scale and 3/4 scale to 1/4 scale. Load is  $2\text{k}\Omega$  in parallel with  $100\text{pF}$  to GND.

**Note 10:** Temperature coefficient is calculated by dividing the maximum change in output voltage by the specified temperature range.

**Note 11:** Maximum  $V_{IH} = V_{CC(\text{MAX})} + 0.5\text{V}$ .

**Note 12:**  $C_B$  = Capacitance of one bus line in pF.

**Note 13:** All values refer to  $V_{IH} = V_{IN(\text{MIN})}$  and  $V_{IL} = V_{IL(\text{MAX})}$  levels.

**Note 14:** Minimum  $V_{IL}$  exceeds Absolute Maximum rating. This condition won't damage the IC, but could degrade performance.

**Note 15:** Thermal resistance of MSOP package limits  $I_{OUT}$  to  $-5\text{mA} \leq I_{OUT} \leq 5\text{mA}$  for H-grade MSOP parts and  $V_{CC} = 5\text{V} \pm 10\%$ .

# TYPICAL PERFORMANCE CHARACTERISTICS

$T_A = 25^\circ\text{C}$ , unless otherwise noted. LTC2637-L12 (Internal Reference,  $V_{FS} = 2.5\text{V}$ )

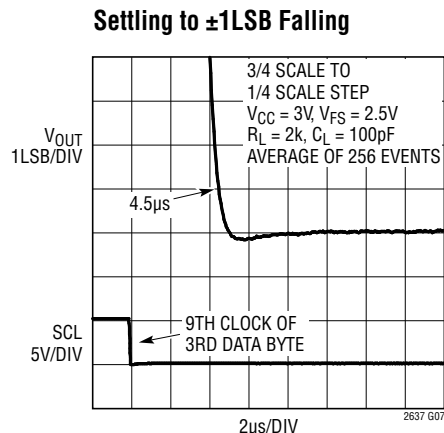
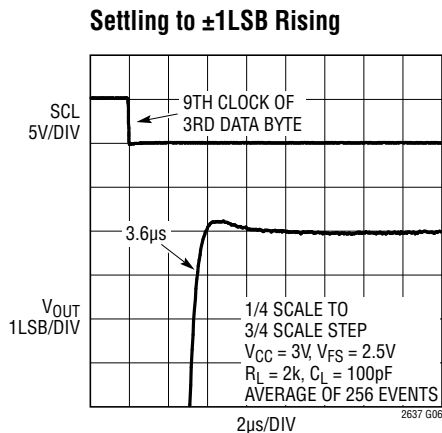
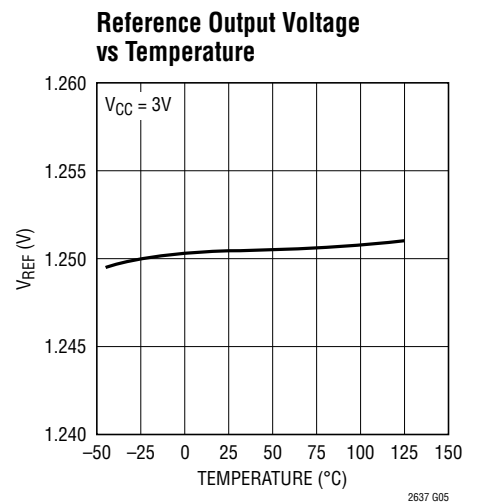
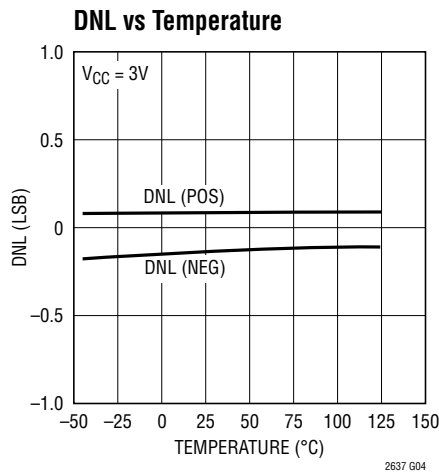
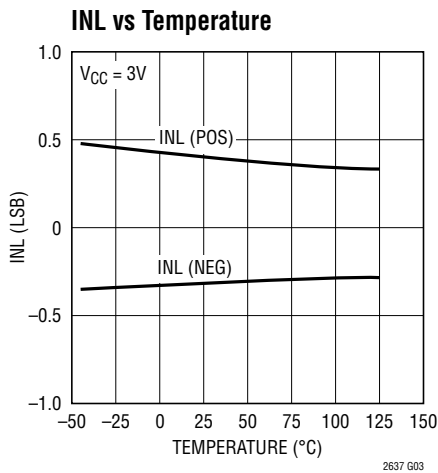
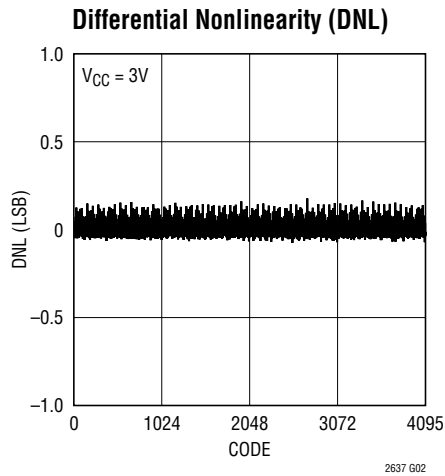
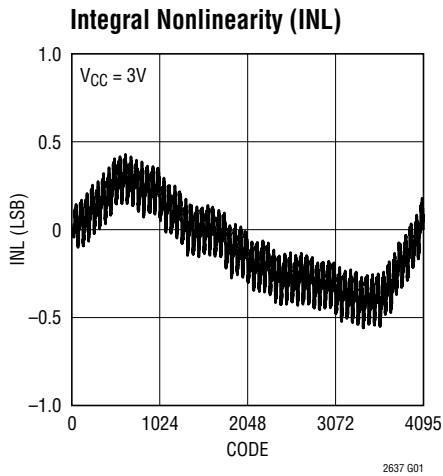

## TYPICAL PERFORMANCE CHARACTERISTICS

$T_A = 25^\circ\text{C}$ , unless otherwise noted. LTC2637-H12 (Internal Reference,  $V_{FS} = 4.096\text{V}$ )



**TYPICAL PERFORMANCE CHARACTERISTICS**  $T_A = 25^\circ\text{C}$ , unless otherwise noted.

LTC2637-10



LTC2637-8



LTC2637

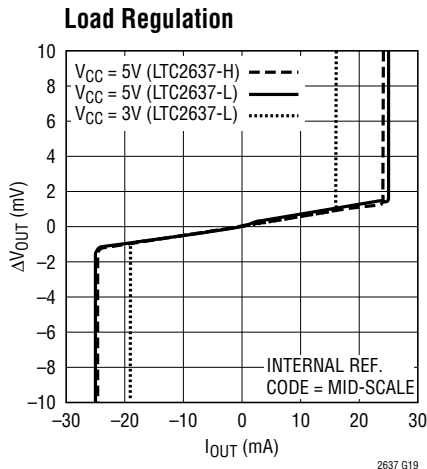

## TYPICAL PERFORMANCE CHARACTERISTICS $T_A = 25^\circ\text{C}$ , unless otherwise noted.

LTC2637

**Large-Signal Response**



**Mid-Scale Glitch Impulse**



**Power-On Reset Glitch**

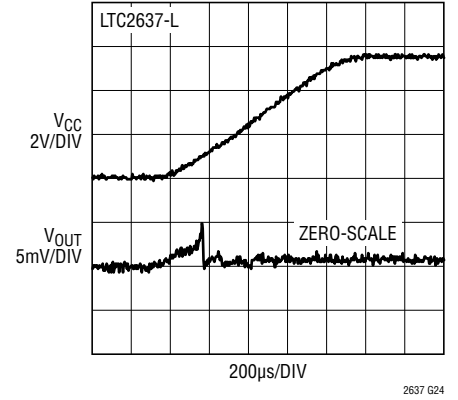

**Headroom at Rails vs Output Current**



**Exiting Power-Down to Mid-Scale**



**Power-On Reset to Mid-Scale**

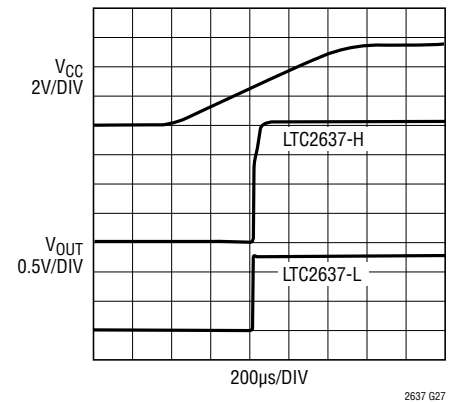

**Supply Current vs Logic Voltage**



**DAC to DAC Crosstalk (Dynamic)**



**Multiplying Bandwidth**



**TYPICAL PERFORMANCE CHARACTERISTICS**  $T_A = 25^\circ\text{C}$ , unless otherwise noted.

LTC2637

**Gain Error vs. Temperature**

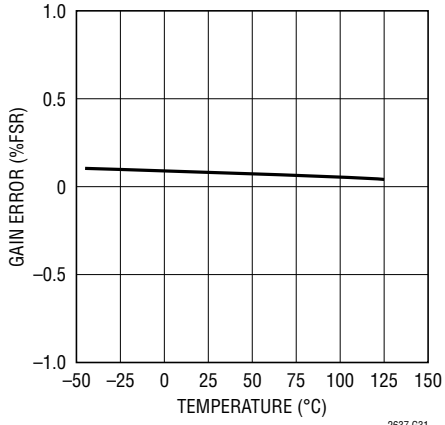

**Noise Voltage vs. Frequency**

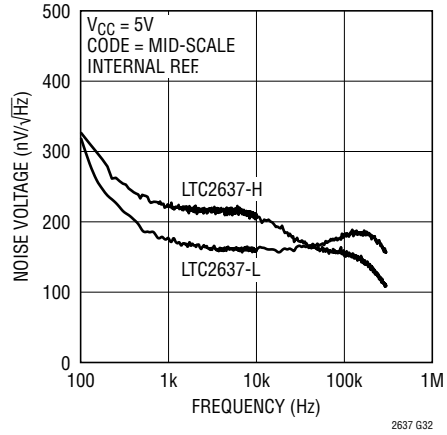

**Gain Error vs Reference Input**

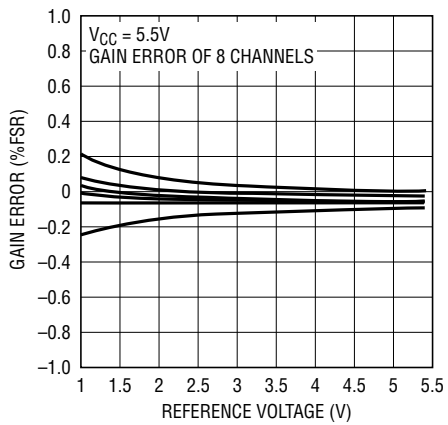

**0.1Hz to 10Hz Voltage Noise**

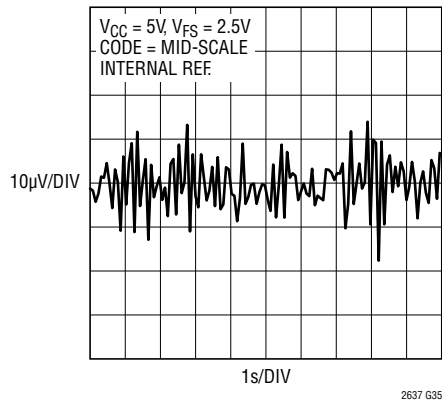

## PIN FUNCTIONS (DFN/MSOP)

**V<sub>CC</sub> (Pin 1/Pin 1):** Supply Voltage Input.  $2.7V \leq V_{CC} \leq 5.5V$  (LTC2637-L) or  $4.5V \leq V_{CC} \leq 5.5V$  (LTC2637-H). Bypass to GND with a 0.1 $\mu$ F capacitor.

**V<sub>OUTA</sub> to V<sub>OUTH</sub> (Pins 2–5, 10–13/Pins 2–5, 12–15):** DAC Analog Voltage Outputs.

**CA0 (Pin 6/Pin 7):** Chip Address Bit 0. Tie this pin to V<sub>CC</sub>, GND or leave it floating to select an I<sup>2</sup>C slave address for the part (See Tables 1 and 2).

**SCL (Pin 7/Pin 8):** Serial Clock Input Pin. Data is shifted into the SDA pin at the rising edges of the clock. This high impedance pin requires a pull-up resistor or current source to V<sub>CC</sub>.

**SDA (Pin 8/Pin 9):** Serial Data Bidirectional Pin. Data is shifted into the SDA pin and acknowledged by the SDA pin. This pin is high impedance while data is shifted in. Open drain N-channel output during acknowledgment. SDA requires a pull-up resistor or current source to V<sub>CC</sub>.

**REF (Pin 9/Pin 11):** Reference Voltage Input or Output. When External Reference mode is selected, REF is an input ( $1V \leq V_{REF} \leq V_{CC}$ ) where the voltage supplied sets the full-scale DAC output voltage. When Internal Reference is selected, the 10ppm/°C 1.25V (LTC2637-L) or 2.048V (LTC2637-H) internal reference (half full-scale) is available at the pin. This output may be bypassed to GND with up to 10 $\mu$ F, and must be buffered when driving external DC load current.

**GND (Pin 14/Pin 16):** Ground.

**CA2 (Pin 6, MSOP only):** Chip Address Bit 2. Tie this pin to V<sub>CC</sub>, GND or leave it floating to select an I<sup>2</sup>C slave address for the part (See Table 1).

**CA1 (Pin 10, MSOP only):** Chip Address Bit 1. Tie this pin to V<sub>CC</sub>, GND or leave it floating to select an I<sup>2</sup>C slave address for the part (See Table 1).

**Exposed Pad (Pin 15, DFN Only):** Ground. Must be soldered to PCB Ground.



**BLOCK DIAGRAM**



TEST CIRCUITS

Test Circuit 1

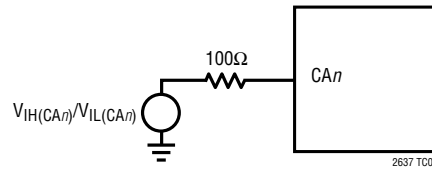

Test Circuit 2

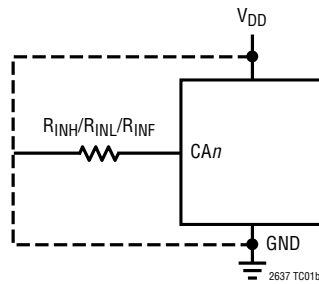

# TIMING DIAGRAM



ALL VOLTAGE LEVELS REFER TO  $V_{IH(MIN)}$  AND  $V_{IL(MAX)}$  LEVELS

Figure 1. I<sup>2</sup>C Timing

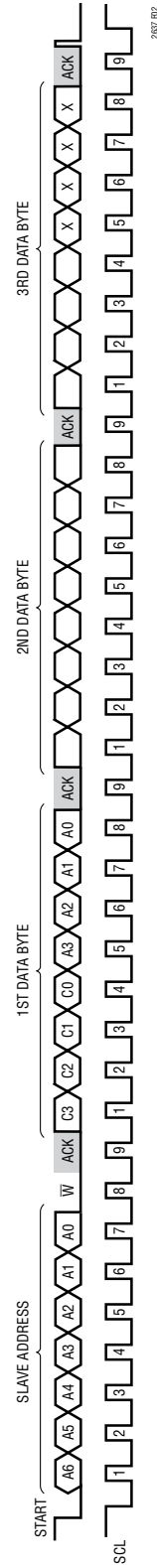

Figure 2. Typical LTC2637 Write Transaction

## OPERATION

The LTC2637 is a family of octal voltage output DACs in 14-lead DFN and 16-lead MSOP packages. Each DAC can operate rail-to-rail using an external reference, or with its full-scale voltage set by an integrated reference. Eighteen combinations of accuracy (12-, 10-, and 8-bit), power-on reset value (zero-scale, mid-scale in internal reference mode, or mid-scale in external reference mode), and full-scale voltage (2.5V or 4.096V) are available. The LTC2637 is controlled using a 2-wire I<sup>2</sup>C interface.

### Power-On Reset

The LTC2637-HZ/LTC2637-LZ clear the output to zero-scale when power is first applied, making system initialization consistent and repeatable.

For some applications, downstream circuits are active during DAC power-up, and may be sensitive to nonzero outputs from the DAC during this time. The LTC2637 contains circuitry to reduce the power-on glitch: the analog output typically rises less than 5mV above zero-scale during power on. In general, the glitch amplitude decreases as the power supply ramp time is increased. See Power-On Reset Glitch in the Typical Performance Characteristics section.

The LTC2637-HMI/LTC2637-HMX/LTC2637-LMI/LTC2637-LMX provide an alternative reset, setting the output to mid-scale when power is first applied. The LTC2637-LMI and LTC2637-HMI power up in internal reference mode, with the output set to a mid-scale voltage of 1.25V and 2.048V, respectively. The LTC2637-LMX and LTC2637-HMX power-up in external reference mode, with the output set to mid-scale of the external reference. Default reference mode selection is described in the Reference Modes section.

### Power Supply Sequencing

The voltage at REF (Pin 9, DFN; Pin 11, MSOP) must be kept within the range  $-0.3V \leq V_{REF} \leq V_{CC} + 0.3V$  (see Absolute Maximum Ratings). Particular care should be taken to observe these limits during power supply turn-on and turn-off sequences, when the voltage at V<sub>CC</sub> is in transition.

### Transfer Function

The digital-to-analog transfer function is:

$$V_{OUT(IDEAL)} = \left( \frac{k}{2^N} \right) V_{REF}$$

where k is the decimal equivalent of the binary DAC input code, N is the resolution, and V<sub>REF</sub> is either 2.5V (LTC2637-LMI/LTC2637-LMX/LTC2637-LZ) or 4.096V (LTC2637-HMI/LTC2637-HMX/LTC2637-HZ) when in Internal Reference mode, and the voltage at REF when in External Reference mode.

### I<sup>2</sup>C Serial Interface

The LTC2637 communicates with a host using the standard 2-wire I<sup>2</sup>C interface. The timing diagrams (Figures 1 and 2) show the timing relationship of the signals on the bus. The two bus lines, SDA and SCL, must be high when the bus is not in use. External pull-up resistors or current sources are required on these lines. The value of these pull-up resistors is dependent on the power supply and can be obtained from the I<sup>2</sup>C specifications. For an I<sup>2</sup>C bus operating in the fast mode, an active pull-up will be necessary if the bus capacitance is greater than 200pF.

The LTC2637 is a receive-only (slave) device. The master can write to the LTC2637. The LTC2637 will not acknowledge (NAK) a read request from the master.

### START (S) and STOP (P) Conditions

When the bus is not in use, both SCL and SDA must be high. A bus master signals the beginning of a communication to a slave device by transmitting a START condition. A START condition is generated by transitioning SDA from high to low while SCL is high.

When the master has finished communicating with the slave, it issues a STOP condition. A STOP condition is generated by transitioning SDA from low to high while SCL is high. The bus is then free for communication with another I<sup>2</sup>C device.

## OPERATION

### Acknowledge

The Acknowledge (ACK) signal is used for handshaking between the master and the slave. An ACK (active LOW) generated by the slave lets the master know that the latest byte of information was properly received. The ACK related clock pulse is generated by the master. The master releases the SDA line (HIGH) during the ACK clock pulse. The slave-receiver must pull down the SDA bus line during the ACK clock pulse so that it remains a stable LOW during the HIGH period of this clock pulse. The LTC2637 responds to a write by a master in this manner but does not acknowledge a read operation; in that case, SDA is retained HIGH during the period of the ACK clock pulse.

### Chip Address

The state of pins CA0, CA1 and CA2 (CA1 and CA2 are only available on the MSOP package) determines the slave address of the part. These pins can each be set to any one of three states:  $V_{CC}$ , GND or float. This results in 27 (MSOP Package) or 3 (DFN Package) selectable addresses for the part. The slave address assignments are shown in Tables 1 and 2.

In addition to the address selected by the address pins, the part also responds to a global address. This address allows a common write to all LTC2637 parts to be accomplished using one 3-byte write transaction on the I<sup>2</sup>C bus. The global address, listed at the end of Tables 1 and 2, is a 7-bit hardwired address not selectable by CA0, CA1 or CA2. If another global address is required, please consult the factory.

The maximum capacitive load allowed on the address pins (CA0, CA1 and CA2) is 10pF, as these pins are driven during address detection to determine if they are floating.

**Table 1. Slave Address Map (MSOP Package)**

| CA2            | CA1      | CA0      | A6 | A5 | A4 | A3 | A2 | A1 | A0 |
|----------------|----------|----------|----|----|----|----|----|----|----|
| GND            | GND      | GND      | 0  | 0  | 1  | 0  | 0  | 0  | 0  |
| GND            | GND      | FLOAT    | 0  | 0  | 1  | 0  | 0  | 0  | 1  |
| GND            | GND      | $V_{CC}$ | 0  | 0  | 1  | 0  | 0  | 1  | 0  |
| GND            | FLOAT    | GND      | 0  | 0  | 1  | 0  | 0  | 1  | 1  |
| GND            | FLOAT    | FLOAT    | 0  | 1  | 0  | 0  | 0  | 0  | 0  |
| GND            | FLOAT    | $V_{CC}$ | 0  | 1  | 0  | 0  | 0  | 0  | 1  |
| GND            | $V_{CC}$ | GND      | 0  | 1  | 0  | 0  | 0  | 1  | 0  |
| GND            | $V_{CC}$ | FLOAT    | 0  | 1  | 0  | 0  | 0  | 1  | 1  |
| GND            | $V_{CC}$ | $V_{CC}$ | 0  | 1  | 1  | 0  | 0  | 0  | 0  |
| FLOAT          | GND      | GND      | 0  | 1  | 1  | 0  | 0  | 0  | 1  |
| FLOAT          | GND      | FLOAT    | 0  | 1  | 1  | 0  | 0  | 1  | 0  |
| FLOAT          | GND      | $V_{CC}$ | 0  | 1  | 1  | 0  | 0  | 1  | 1  |
| FLOAT          | FLOAT    | GND      | 1  | 0  | 0  | 0  | 0  | 0  | 0  |
| FLOAT          | FLOAT    | FLOAT    | 1  | 0  | 0  | 0  | 0  | 0  | 1  |
| FLOAT          | FLOAT    | $V_{CC}$ | 1  | 0  | 0  | 0  | 0  | 1  | 0  |
| FLOAT          | $V_{CC}$ | GND      | 1  | 0  | 0  | 0  | 0  | 1  | 1  |
| FLOAT          | $V_{CC}$ | FLOAT    | 1  | 0  | 1  | 0  | 0  | 0  | 0  |
| FLOAT          | $V_{CC}$ | $V_{CC}$ | 1  | 0  | 1  | 0  | 0  | 0  | 1  |
| $V_{CC}$       | GND      | GND      | 1  | 0  | 1  | 0  | 0  | 1  | 0  |
| $V_{CC}$       | GND      | FLOAT    | 1  | 0  | 1  | 0  | 0  | 1  | 1  |
| $V_{CC}$       | GND      | $V_{CC}$ | 1  | 1  | 0  | 0  | 0  | 0  | 0  |
| $V_{CC}$       | FLOAT    | GND      | 1  | 1  | 0  | 0  | 0  | 0  | 1  |
| $V_{CC}$       | FLOAT    | FLOAT    | 1  | 1  | 0  | 0  | 0  | 1  | 0  |
| $V_{CC}$       | FLOAT    | $V_{CC}$ | 1  | 1  | 0  | 0  | 0  | 1  | 1  |
| $V_{CC}$       | $V_{CC}$ | GND      | 1  | 1  | 1  | 0  | 0  | 0  | 0  |
| $V_{CC}$       | $V_{CC}$ | FLOAT    | 1  | 1  | 1  | 0  | 0  | 0  | 1  |
| $V_{CC}$       | $V_{CC}$ | $V_{CC}$ | 1  | 1  | 1  | 0  | 0  | 1  | 0  |
| GLOBAL ADDRESS |          |          | 1  | 1  | 1  | 0  | 0  | 1  | 1  |

**Table 2. Slave Address Map (DFN Package)**

| CA0            | A6 | A5 | A4 | A3 | A2 | A1 | A0 |
|----------------|----|----|----|----|----|----|----|
| GND            | 0  | 0  | 1  | 0  | 0  | 0  | 0  |
| FLOAT          | 0  | 0  | 1  | 0  | 0  | 0  | 1  |
| $V_{CC}$       | 0  | 0  | 1  | 0  | 0  | 1  | 0  |
| GLOBAL ADDRESS | 1  | 1  | 1  | 0  | 0  | 1  | 1  |

## OPERATION

### Write Word Protocol

The master initiates communication with the LTC2637 with a START condition and a 7-bit slave address followed by the Write bit ( $\overline{W}$ ) = 0. The LTC2637 acknowledges by pulling the SDA pin low at the 9th clock if the 7-bit slave address matches the address of the part (set by CA0, CA1 or CA2) or the global address. The master then transmits three bytes of data. The LTC2637 acknowledges each byte of data by pulling the SDA line low at the 9th clock of each data byte transmission. After receiving three complete bytes of data, the LTC2637 executes the command specified in the 24-bit input word.

If more than three data bytes are transmitted after a valid 7-bit slave address, the LTC2637 does not acknowledge the extra bytes of data (SDA is high during the 9th clock).

The format of the three data bytes is shown in Figure 3. The first byte of the input word consists of the 4-bit command, followed by the 4-bit DAC address. The next two bytes contain the 16-bit data word, which consists of the 12-, 10- or 8-bit input code, MSB to LSB, followed by 4, 6 or 8 don't-care bits (LTC2637-12, LTC2637-10 and LTC2637-8, respectively). A typical LTC2637 write transaction is shown in Figure 4.

The command bit assignments (C3-C0) and address (A3-A0) assignments are shown in Tables 3 and 4. The first four commands in the table consist of write and update operations. A write operation loads a 16-bit data word from the 32-bit shift register into the input register. In an update operation, the data word is copied from the input register to the DAC register. Once copied into the DAC register, the data word becomes the active 12-, 10-, or 8-bit input code, and is converted to an analog voltage at the DAC output. Write to and Update combines the first two commands. The Update operation also powers up the DAC if it had been in power-down mode. The data path and registers are shown in the Block Diagram.

**Table 3. Command Codes**

| COMMAND* |    |    |    |   |
|----------|----|----|----|---|
| C3       | C2 | C1 | C0 |   |
| 0        | 0  | 0  | 0  | Write to Input Register n                                 |
| 0        | 0  | 0  | 1  | Update (Power Up) DAC Register n                          |
| 0        | 0  | 1  | 0  | Write to Input Register n, Update (Power Up) All          |
| 0        | 0  | 1  | 1  | Write to and Update (Power Up) DAC Register n             |
| 0        | 1  | 0  | 0  | Power Down n  |
| 0        | 1  | 0  | 1  | Power Down Chip (All DAC's and Reference)                 |
| 0        | 1  | 1  | 0  | Select Internal Reference (Power Up Reference)            |
| 0        | 1  | 1  | 1  | Select External Reference (Power Down Internal Reference) |
| 1        | 1  | 1  | 1  | No Operation  |

\*Command codes not shown are reserved and should not be used.

**Table 4. Address Codes**

| ADDRESS (n)* |    |    |    |          |
|--------------|----|----|----|----------|
| A3           | A2 | A1 | A0 |          |
| 0            | 0  | 0  | 0  | DAC A    |
| 0            | 0  | 0  | 1  | DAC B    |
| 0            | 0  | 1  | 0  | DAC C    |
| 0            | 0  | 1  | 1  | DAC D    |
| 0            | 1  | 0  | 0  | DAC E    |
| 0            | 1  | 0  | 1  | DAC F    |
| 0            | 1  | 1  | 0  | DAC G    |
| 0            | 1  | 1  | 1  | DAC H    |
| 1            | 1  | 1  | 1  | All DACs |

\*Address codes not shown are reserved and should not be used.

### Reference Modes

For applications where an accurate external reference is either not available, or not desirable due to limited space, the LTC2637 has a user-selectable, integrated reference. The integrated reference voltage is internally amplified by 2x to provide the full-scale DAC output voltage range.

## OPERATION



Figure 3. Command and Data Input Format

The LTC2637-LMI/LTC2637-LMX/LTC2637-LZ provides a full-scale output of 2.5V. The LTC2637-HMI/LTC2637-HMX/LTC2637-HZ provides a full-scale output of 4.096V. The internal reference can be useful in applications where the supply voltage is poorly regulated. Internal Reference mode can be selected by using command 0110b, and is the power-on default for LTC2637-HZ/LTC2637-LZ, as well as for LTC2637-HMI/LTC2637-LMI.

The 10ppm/°C, 1.25V (LTC2637-LMI/LTC2637-LMX/LTC2637-LZ) or 2.048V (LTC2637-HMI/LTC2637-HMX/LTC2637-HZ) internal reference is available at the REF pin. Adding bypass capacitance to the REF pin will improve noise performance; and up to 10 $\mu$ F can be driven without oscillation. The REF output must be buffered when driving an external DC load current.

Alternatively, the DAC can operate in External Reference mode using command 0111b. In this mode, an input voltage supplied externally to the REF pin provides the reference ( $1V \leq V_{REF} \leq V_{CC}$ ) and the supply current is reduced. The external reference voltage supplied sets the full-scale DAC output voltage. External Reference mode is the power-on default for LTC2637-HMX/LTC2637-LMX.

The reference mode of LTC2637-HZ/LTC2637-LZ/LTC2637-HMI/LTC2637-LMI (internal reference power-on default), can be changed by software command after power up. The same is true for LTC2637-HMX/LTC2637-LMX (external reference power-on default).

### Power-Down Mode

For power-constrained applications, power-down mode can be used to reduce the supply current whenever less than eight DAC outputs are needed. When in power-down, the buffer amplifiers, bias circuits, and integrated reference circuits are disabled, and draw essentially zero current. The DAC outputs are put into a high-impedance state, and the output pins are passively pulled to ground through individual 200k $\Omega$  resistors. Input and DAC register contents are not disturbed during power down.

Any DAC channel or combination of channels can be put into power-down mode by using command 0100b in combination with the appropriate DAC address, (n). The supply current is reduced approximately 10% for each DAC powered down. The integrated reference is automatically powered down when external reference is selected using

## OPERATION

command 0111b. In addition, all the DAC channels and the integrated reference together can be put into power-down mode using Power Down Chip command 0101b. When the integrated reference and all DAC channels are in power-down mode, the REF pin becomes high impedance (typically  $> 1\text{G}\Omega$ ). For all power-down commands the 16-bit data word is ignored.

Normal operation resumes after executing any command that includes a DAC update, (as shown in Table 1). The selected DAC is powered up as its voltage output is updated. When a DAC which is in a powered-down state is powered up and updated, normal settling is delayed. If less than eight DACs are in a powered-down state prior to the update command, the power-up delay time is  $10\mu\text{s}$ . However, if all eight DACs and the integrated reference are powered down, then the main bias generation circuit block has been automatically shut down in addition to the DAC amplifiers and reference buffers. In this case, the power up delay time is  $12\mu\text{s}$ . The power-up of the integrated reference depends on the command that powered it down. If the reference is powered down using the Select External Reference Command (0111b), then it can only be powered back up using Select Internal Reference Command (0110b). However, if the reference was powered down using Power Down Chip Command (0101b), then in addition to Select Internal Reference Command (0110b), any command that powers up the DACs will also power up the integrated reference.

### Voltage Output

The LTC2637's DAC output integrated rail-to-rail amplifiers have guaranteed load regulation when sourcing or sinking up to  $10\text{mA}$  at  $5\text{V}$ , and  $5\text{mA}$  at  $3\text{V}$ .

Load regulation is a measure of the amplifier's ability to maintain the rated voltage accuracy over a wide range of load current. The measured change in output voltage per change in forced load current is expressed in  $\text{LSB}/\text{mA}$ .

DC output impedance is equivalent to load regulation, and may be derived from it by simply calculating a change in units from  $\text{LSB}/\text{mA}$  to ohms. The amplifier's DC output impedance is  $0.1\Omega$  when driving a load well away from the rails.

When drawing a load current from either rail, the output voltage headroom with respect to that rail is limited by the  $50\Omega$  typical channel resistance of the output devices (e.g., when sinking  $1\text{mA}$ , the minimum output voltage is  $50\Omega \cdot 1\text{mA}$ , or  $50\text{mV}$ ). See the graph Headroom at Rails vs Output Current in the Typical Performance Characteristics section.

The amplifier is stable driving capacitive loads of up to  $500\text{pF}$ .

### Rail-to-Rail Output Considerations

In any rail-to-rail voltage output device, the output is limited to voltages within the supply range.

Since the analog output of the DAC cannot go below ground, it may limit for the lowest codes as shown in Figure 5b. Similarly, limiting can occur near full scale when the REF pin is tied to  $V_{\text{CC}}$ . If  $V_{\text{REF}} = V_{\text{CC}}$  and the DAC full-scale error (FSE) is positive, the output for the highest codes limits at  $V_{\text{CC}}$ , as shown in Figure 5c. No full-scale limiting can occur if  $V_{\text{REF}}$  is less than  $V_{\text{CC}} - \text{FSE}$ .

Offset and linearity are defined and tested over the region of the DAC transfer function where no output limiting can occur.

### Board Layout

The PC board should have separate areas for the analog and digital sections of the circuit. A single, solid ground plane should be used, with analog and digital signals carefully routed over separate areas of the plane. This keeps digital signals away from sensitive analog signals and minimizes the interaction between digital ground currents



## OPERATION

and the analog section of the ground plane. The resistance from the LTC2637 GND pin to the ground plane should be as low as possible. Resistance here will add directly to the effective DC output impedance of the device (typically  $0.1\Omega$ ). Note that the LTC2637 is no more susceptible to this effect than any other parts of this type; on the contrary, it allows layout-based performance improvements to shine rather than limiting attainable performance with excessive internal resistance.

Another technique for minimizing errors is to use a separate power ground return trace on another board layer. The trace should run between the point where the power

supply is connected to the board and the DAC ground pin. Thus the DAC ground pin becomes the common point for analog ground, digital ground, and power ground. When the LTC2637 is sinking large currents, this current flows out the ground pin and directly to the power ground trace without affecting the analog ground plane voltage.

It is sometimes necessary to interrupt the ground plane to confine digital ground currents to the digital portion of the plane. When doing this, make the gap in the plane only as long as it needs to be to serve its purpose and ensure that no traces cross over the gap.

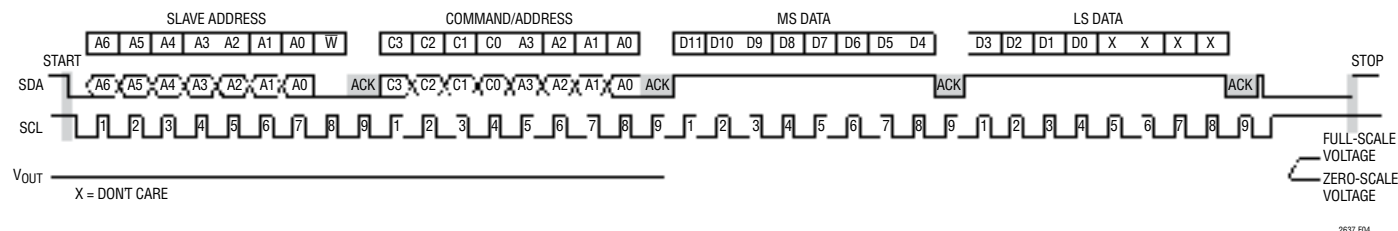

Figure 4. Typical LTC2637 Input Waveform—Programming DAC Output for Full-Scale



Figure 5. Effects of Rail-to-Rail Operation On a DAC Transfer Curve (Shown for 12 Bits).  
 (a) Overall Transfer Function  
 (b) Effect of Negative Offset for Codes Near Zero  
 (c) Effect of Positive Full-Scale Error for Codes Near Full-Scale

## TYPICAL APPLICATION

LTC2637 DACs Adjust LTC2755-16 Offsets, Amplified with LT1991 PGA to  $\pm 5V$



## PACKAGE DESCRIPTION

Please refer to <http://www.linear.com/product/LTC2637#packaging> for the most recent package drawings.

**DE Package**  
**14-Lead Plastic DFN (4mm × 3mm)**  
 (Reference LTC DWG # 05-08-1708 Rev B)



RECOMMENDED SOLDER PAD PITCH AND DIMENSIONS  
 APPLY SOLDER MASK TO AREAS THAT ARE NOT SOLDERED



**NOTE:**

1. DRAWING PROPOSED TO BE MADE VARIATION OF VERSION (WGED-3) IN JEDEC PACKAGE OUTLINE MO-229
2. DRAWING NOT TO SCALE
3. ALL DIMENSIONS ARE IN MILLIMETERS
4. DIMENSIONS OF EXPOSED PAD ON BOTTOM OF PACKAGE DO NOT INCLUDE MOLD FLASH. MOLD FLASH, IF PRESENT, SHALL NOT EXCEED 0.15mm ON ANY SIDE
5. EXPOSED PAD SHALL BE SOLDER PLATED
6. SHADED AREA IS ONLY A REFERENCE FOR PIN 1 LOCATION ON THE TOP AND BOTTOM OF PACKAGE

## PACKAGE DESCRIPTION

Please refer to <http://www.linear.com/product/LTC2637#packaging> for the most recent package drawings.

### MS Package 16-Lead Plastic MSOP (Reference LTC DWG # 05-08-1669 Rev A)



**NOTE:**

1. DIMENSIONS IN MILLIMETER/(INCH)
2. DRAWING NOT TO SCALE
3. DIMENSION DOES NOT INCLUDE MOLD FLASH, PROTRUSIONS OR GATE BURRS.  
MOLD FLASH, PROTRUSIONS OR GATE BURRS SHALL NOT EXCEED 0.152mm (.006") PER SIDE
4. DIMENSION DOES NOT INCLUDE INTERLEAD FLASH OR PROTRUSIONS.  
INTERLEAD FLASH OR PROTRUSIONS SHALL NOT EXCEED 0.152mm (.006") PER SIDE
5. LEAD COPLANARITY (BOTTOM OF LEADS AFTER FORMING) SHALL BE 0.102mm (.004") MAX

## REVISION HISTORY

| REV | DATE  | DESCRIPTION  | PAGE NUMBER    |
|-----|-------|--|----------------|
| A   | 10/09 | Update LTC2637-12 Maximum Limits.  | 5, 6, 8        |
| B   | 06/10 | Added details to Note 3.<br>Revised Typical Application circuit.<br>Added Typical Application drawing and revised Related Parts. | 10<br>25<br>28 |
| C   | 06/17 | Updated Note 3.  | 10             |
| D   | 04/18 | Edits to Note 3.   | 10             |

## TYPICAL APPLICATION

LTC2637 DACs Adjust LTC2755-16 Offsets, Amplified with LT<sup>®</sup>1991 PGA to ±5V

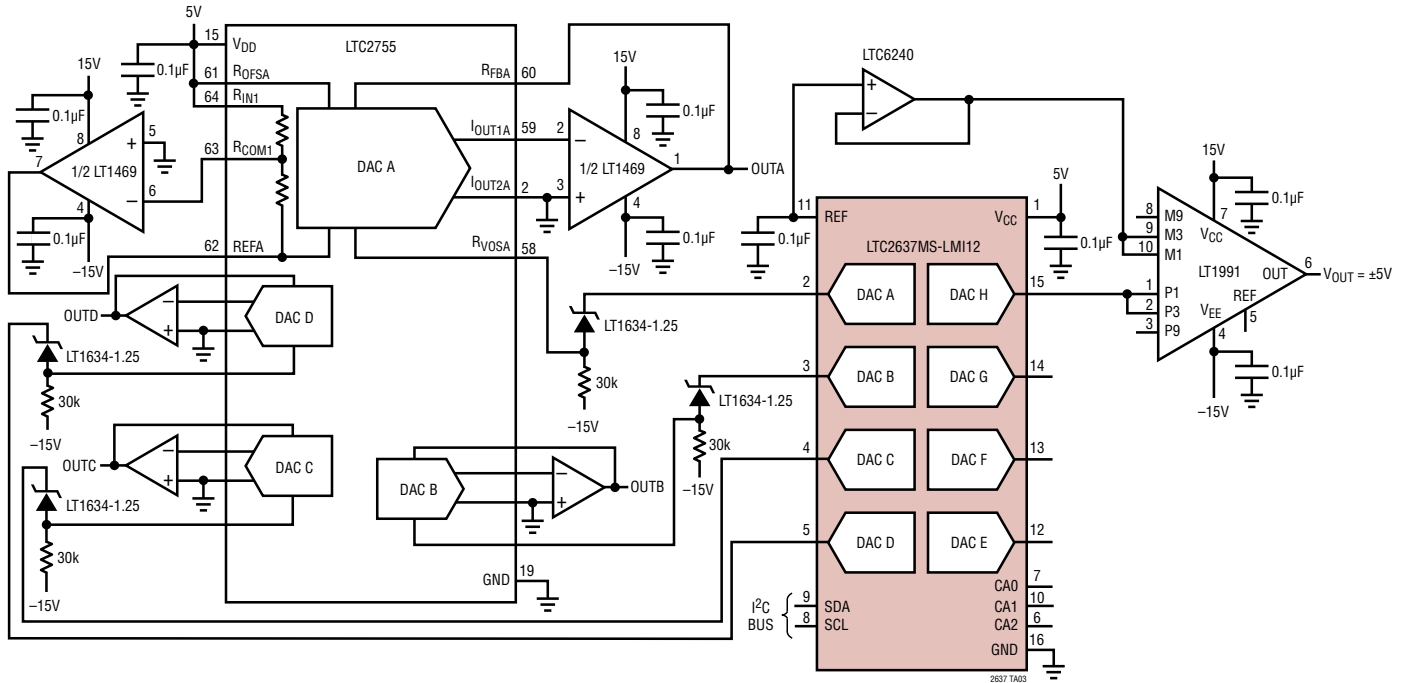

## RELATED PARTS

| PART NUMBER                             | DESCRIPTION   | COMMENTS  |
|---|---|---|
| <a href="#">LTC2636</a>                 | Octal 12-/10-/8-Bit, SPI V <sub>OUT</sub> DACs with 10ppm/°C Reference                    | 125µA per DAC, 2.7V to 5.5V Supply Range, 10ppm/°C Reference, External REF Mode, Rail-to-Rail Output, 14-Lead 4mm × 3mm DFN and 16-Lead MSOP Packages |
| <a href="#">LTC1660/LTC1665</a>         | Octal 10-/8-Bit V <sub>OUT</sub> DACs in 16-Pin Narrow SSOP                               | V <sub>CC</sub> = 2.7V to 5.5V, Micropower, Rail-to-Rail Output   |
| <a href="#">LTC2605/LTC2615/LTC2625</a> | Octal 16-/14-/12-Bit V <sub>OUT</sub> DACs with I <sup>2</sup> C Interface                | 250µA per DAC, 2.7V to 5.5V Supply Range, Rail-to-Rail Output, I <sup>2</sup> C Interface   |
| <a href="#">LTC2600/LTC2610/LTC2620</a> | Octal 16-/14-/12-Bit V <sub>OUT</sub> DACs in 16-Lead Narrow SSOP                         | 250µA per DAC, 2.5V to 5.5V Supply Range, Rail-to-Rail Output, SPI Serial Interface   |
| <a href="#">LTC2656/LTC2657</a>         | Octal 16-/12 Bit, SPI/I <sup>2</sup> C V <sub>OUT</sub> DACs with 10ppm/°C Max Reference  | ±4LSB INL max at 16-Bits and ±2mV Offset Error, Rail-to-Rail Output, 20-Lead 4mm × 5mm QFN and 16-Lead TSSOP Packages                                 |
| <a href="#">LTC2654/LTC2655</a>         | Quad 16-/12 Bit, SPI/I <sup>2</sup> C V <sub>OUT</sub> DACs with 10ppm/°C Max Reference   | ±4LSB INL max at 16-Bits and ±2mV Offset Error, Rail-to-Rail Output, 20-Lead 4mm × 4mm QFN and 16-Lead Narrow SSOP Packages                           |
| <a href="#">LTC2634/LTC2635</a>         | Quad 12-/10-/8-Bit SPI/I <sup>2</sup> C V <sub>OUT</sub> DACs with 10ppm/°C Reference     | ±2.5 LSB INL, 2.7V to 5.5V Supply Range, 10ppm/°C Reference, External REF Mode, 16-Pin 3mm × 3mm QFN and 10-Lead MSOP Packages                        |
| <a href="#">LTC2630/LTC2632</a>         | Single 12-/10-/8-Bit, SPI/ I <sup>2</sup> C V <sub>OUT</sub> DACs with 10ppm/°C Reference | 180µA per DAC, 2.7V to 5.5V Supply Range, 10ppm/°C Reference, Rail-to-Rail Output, in SC70 (LTC2630)/ ThinSOT <sup>™</sup> (LTC2631)                  |
| <a href="#">LTC2640</a>                 | Single 12-/10-/8-Bit, SPI V <sub>OUT</sub> DACs with 10ppm/°C Reference                   | 180µA per DAC, 2.7V to 5.5V Supply Range, 10ppm/°C Reference, External REF Mode, Rail-to-Rail Output, in ThinSOT                                      |

### Amplifiers

|                        |  |  |
|------------------------|--|--|
| <a href="#">LT1991</a> | Precision, 100µA Gain Selectable Amplifier               | Gain Accuracy of 0.04%, Gains from -13 to 14, 100µA Precision Op-Amp         |
| <a href="#">LT1469</a> | Dual 90MHz, 22V/µs 16-Bit Accurate Operational Amplifier | 90MHz Gain Bandwidth, 125µV offset, 900ns, 22V/µs Slew Rate Precision Op-Amp |



Компания «ЭлектроПласт» предлагает заключение долгосрочных отношений при поставках импортных электронных компонентов на взаимовыгодных условиях!

Наши преимущества:

- Оперативные поставки широкого спектра электронных компонентов отечественного и импортного производства напрямую от производителей и с крупнейших мировых складов;
- Поставка более 17-ти миллионов наименований электронных компонентов;
- Поставка сложных, дефицитных, либо снятых с производства позиций;
- Оперативные сроки поставки под заказ (от 5 рабочих дней);
- Экспресс доставка в любую точку России;
- Техническая поддержка проекта, помощь в подборе аналогов, поставка прототипов;
- Система менеджмента качества сертифицирована по Международному стандарту ISO 9001;
- Лицензия ФСБ на осуществление работ с использованием сведений, составляющих государственную тайну;
- Поставка специализированных компонентов (Xilinx, Altera, Analog Devices, Intersil, Interpoint, Microsemi, Aeroflex, Peregrine, Syfer, Eurofarad, Texas Instrument, Miteq, Cobham, E2V, MA-COM, Hittite, Mini-Circuits, General Dynamics и др.);

Помимо этого, одним из направлений компании «ЭлектроПласт» является направление «Источники питания». Мы предлагаем Вам помощь Конструкторского отдела:

- Подбор оптимального решения, техническое обоснование при выборе компонента;
- Подбор аналогов;
- Консультации по применению компонента;
- Поставка образцов и прототипов;
- Техническая поддержка проекта;
- Защита от снятия компонента с производства.



#### Как с нами связаться

**Телефон:** 8 (812) 309 58 32 (многоканальный)

**Факс:** 8 (812) 320-02-42

**Электронная почта:** [org@eplast1.ru](mailto:org@eplast1.ru)

**Адрес:** 198099, г. Санкт-Петербург, ул. Калинина, дом 2, корпус 4, литера А.