

## Optocoupler, Phototransistor Output, AC Input, with Base Connection

Single Channel

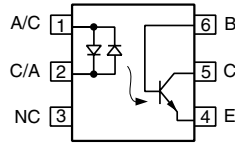

Dual Channel

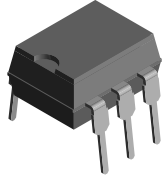
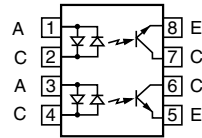
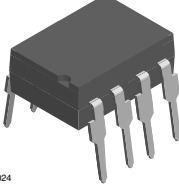

1179024

### DESCRIPTION

The IL250/251/252/ILD250/251/252 are bidirectional input optically coupled isolators consisting of two gallium arsenide infrared LEDs coupled to a silicon NPN phototransistor per channel.

The IL250/ILD250 has a minimum CTR of 50 %, the IL251/ILD251 has a minimum CTR of 20 %, and the IL252/ILD252 has a minimum CTR of 100 %.

The IL250/IL251/IL252 are single channel optocouplers. The ILD250/ILD251/ILD252 has two isolated channels in a single DIP package.

### FEATURES

- AC or polarity insensitive input
- Built-in reverse polarity input protection
- Improved CTR symmetry
- Industry standard DIP package
- Lead (Pb)-free component
- Component in accordance to RoHS 2002/95/EC and WEEE 2002/96/EC



**RoHS**  
COMPLIANT

### APPLICATIONS

- Ideal for AC signal detection and monitoring

### AGENCY APPROVALS

- UL1577, file no. E52744 system code H or J, double protection
- CSA 93751
- BSI IEC 60950; IEC 60065
- DIN EN 60747-5-5 available with option 1

ORDER INFORMATION	
PART	REMARKS
IL250	CTR > 50 %, single channel DIP-6
IL251	CTR > 20 %, single channel DIP-6
IL252	CTR > 100 %, single channel DIP-6
ILD250	CTR > 50 %, dual channel DIP-8
ILD251	CTR > 20 %, dual channel DIP-8
ILD252	CTR > 100 %, dual channel DIP-8
IL250-X007	CTR > 50 %, single channel SMD-6 (option 7)
IL250-X009	CTR > 50 %, single channel SMD-6 (option 9)
IL251-X009	CTR > 20 %, single channel SMD-6 (option 9)
IL252-X007	CTR > 100 %, single channel SMD-6 (option 7)
IL252-X009	CTR > 100 %, single channel SMD-6 (option 9)
ILD250-X009	CTR > 50 %, dual channel SMD-6 (option 9)
ILD251-X006	CTR > 20 %, dual channel DIP-8 400 mil (option 6)
ILD251-X007	CTR > 20 %, dual channel SMD-6 (option 7)
ILD251-X009	CTR > 20 %, dual channel SMD-6 (option 9)
ILD252-X009	CTR > 100 %, dual channel SMD-6 (option 9)

### Note

For additional information on the available options refer to option information.

# IL250/251/252/ILD250/251/252



Vishay Semiconductors Optocoupler, Phototransistor Output,  
AC Input, with Base Connection

ABSOLUTE MAXIMUM RATINGS				
PARAMETER	TEST CONDITION	SYMBOL	VALUE	UNIT
<b>INPUT</b>				
Forward continuous current		$I_F$	60	mA
Power dissipation		$P_{diss}$	100	mW
Derate linearly from 25 °C			1.33	mW/°C
<b>OUTPUT</b>				
Collector emitter breakdown voltage		$BV_{CEO}$	30	V
Emitter base breakdown voltage		$BV_{EBO}$	5.0	V
Collector base breakdown voltage		$BV_{CBO}$	70	V
Power dissipation single channel		$P_{diss}$	200	mW
Power dissipation dual channel		$P_{diss}$	150	mW
Derate linearly from 25 °C single channel			2.6	mW/°C
Derate linearly from 25 °C dual channel			2.0	mW/°C
<b>COUPLER</b>				
Isolation test voltage (between emitter and detector referred to standard climate 23 °C/ 50 % RH, DIN 50014)		$V_{ISO}$	5300	$V_{RMS}$
Creepage distance			≥ 7.0	mm
Clearance distance			≥ 7.0	mm
Isolation resistance	$V_{IO} = 500\text{ V}, T_{amb} = 25\text{ °C}$	$R_{IO}$	$10^{12}$	$\Omega$
	$V_{IO} = 500\text{ V}, T_{amb} = 100\text{ °C}$	$R_{IO}$	$10^{11}$	$\Omega$
Total dissipation single channel		$P_{tot}$	250	mW
Total dissipation dual channel		$P_{tot}$	400	mW
Derate linearly from 25 °C single channel			3.3	mW/°C
Derate linearly from 25 °C dual channel			5.3	mW/°C
Storage temperature		$T_{stg}$	- 55 to + 150	°C
Operating temperature		$T_{amb}$	- 55 to + 100	°C
Lead soldering time at 260 °C			10	s

## Note

$T_{amb} = 25\text{ °C}$ , unless otherwise specified

Stresses in excess of the absolute maximum ratings can cause permanent damage to the device. Functional operation of the device is not implied at these or any other conditions in excess of those given in the operational sections of this document. Exposure to absolute maximum ratings for extended periods of the time can adversely affect reliability.

ELECTRICAL CHARACTERISTICS							
PARAMETER	TEST CONDITION	PART	SYMBOL	MIN.	TYP.	MAX.	UNIT
<b>INPUT</b>							
Forward voltage	$I_F = \pm 10\text{ mA}$		$V_F$		1.2	1.5	V
<b>OUTPUT</b>							
Collector emitter breakdown voltage	$I_C = 1.0\text{ mA}$		$BV_{CEO}$	30	50		V
Emitter base breakdown voltage	$I_E = 100\text{ }\mu\text{A}$		$BV_{EBO}$	7.0	10		V
Collector base breakdown voltage	$I_C = 10\text{ }\mu\text{A}$		$BV_{CBO}$	70	90		V
Collector emitter leakage current	$V_{CE} = 10\text{ V}$		$I_{CEO}$		5.0	50	nA
<b>COUPLER</b>							
Collector emitter saturation voltage	$I_F = \pm 16\text{ mA}, I_C = 2.0\text{ mA}$		$V_{CEsat}$			0.4	V

## Note

$T_{amb} = 25\text{ °C}$ , unless otherwise specified

Minimum and maximum values are testing requirements. Typical values are characteristics of the device and are the result of engineering evaluation. Typical values are for information only and are not part of the testing requirements.



CURRENT TRANSFER RATIO							
PARAMETER	TEST CONDITION	PART	SYMBOL	MIN.	TYP.	MAX.	UNIT
DC current transfer ratio	$I_F = \pm 10 \text{ mA}, V_{CE} = 10 \text{ V}$	IL250/ILD250	$CTR_{DC}$	50			%
		IL251/ILD251	$CTR_{DC}$	20			%
		IL251/ILD251	$CTR_{DC}$	100			%
Symmetry (CTR at +10 mA)/ (CTR at -10 mA)				0.50	1.0	2.0	

**TYPICAL CHARACTERISTICS**

$T_{amb} = 25 \text{ }^\circ\text{C}$ , unless otherwise specified

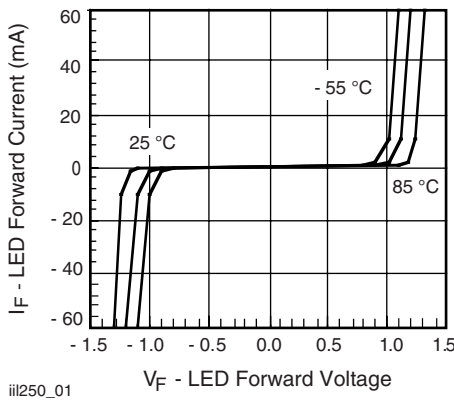

Fig. 1 - LED Forward Current vs. Forward Voltage

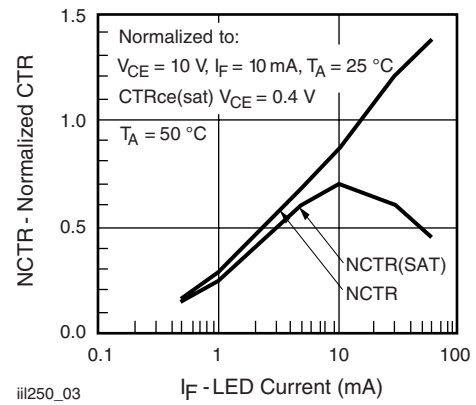

Fig. 3 - Normalized Non-Saturated and Saturated CTR vs. LED Current

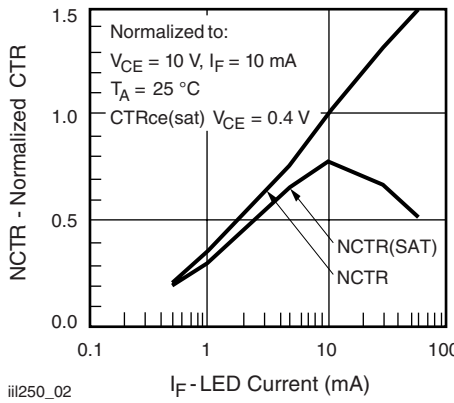

Fig. 2 - Normalized Non-Saturated and Saturated CTR vs. LED Current

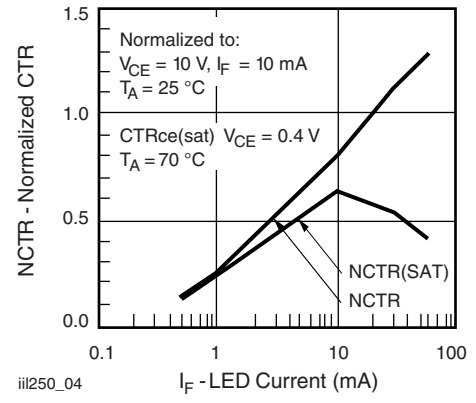

Fig. 4 - Normalized Non-Saturated and Saturated CTR vs. LED Current

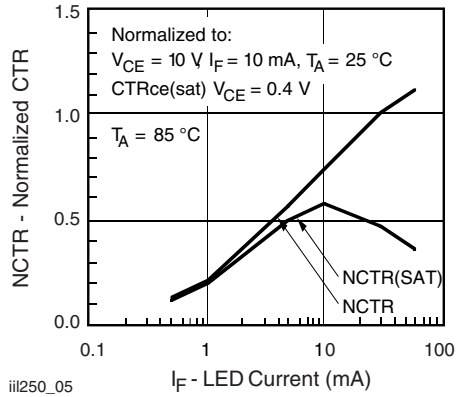

Fig. 5 - Normalized Non-Saturated and Saturated CTR vs. LED Current

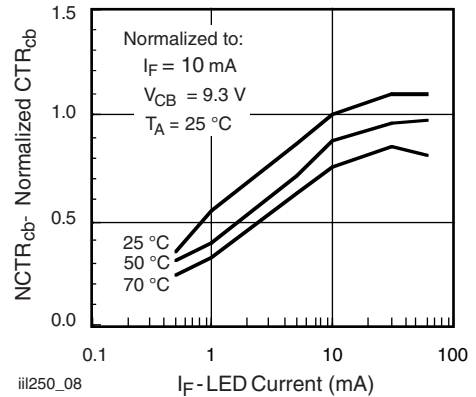

Fig. 8 - Normalized  $CTR_{CB}$  vs. LED Current and Temperature

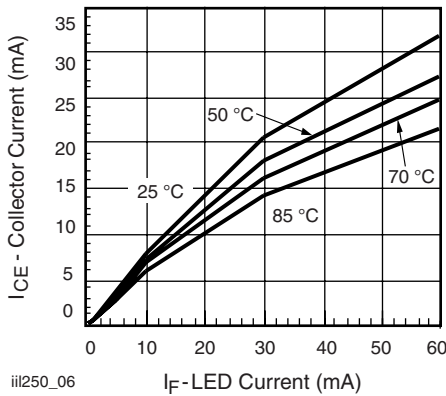

Fig. 6 - Collector Emitter Current vs. Temperature and LED Current

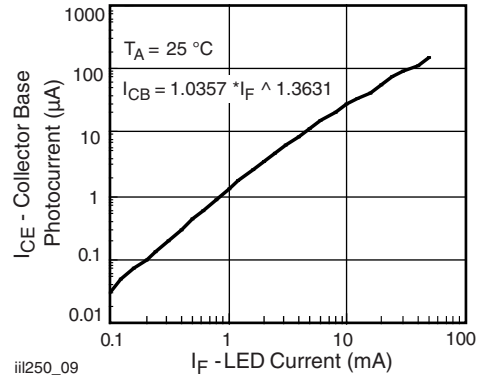

Fig. 9 - Collector Base Photocurrent vs. LED Current

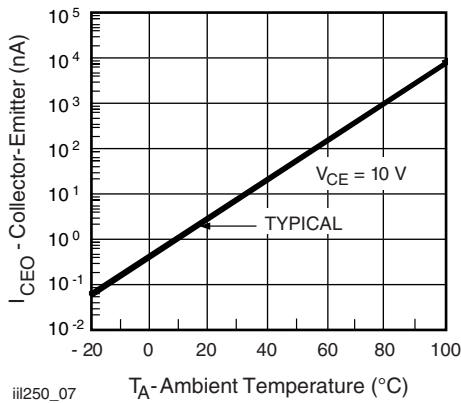

Fig. 7 - Collector Emitter Leakage Current vs. Temperature

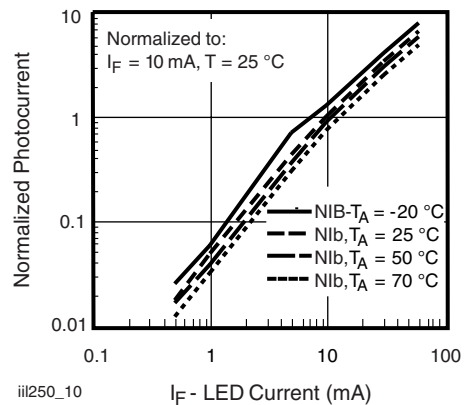

Fig. 10 - Normalized Photocurrent vs.  $I_F$  and Temperature

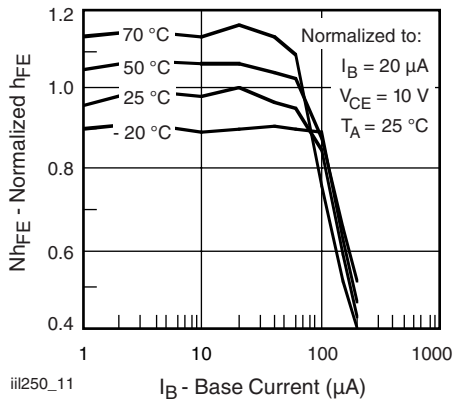

Fig. 11 - Normalized Non Saturated  $h_{FE}$  vs. Base Current and Temperature

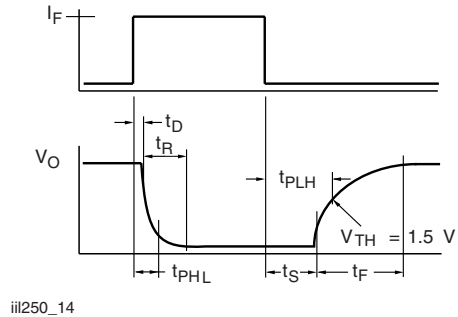

Fig. 14 - Switching Timing

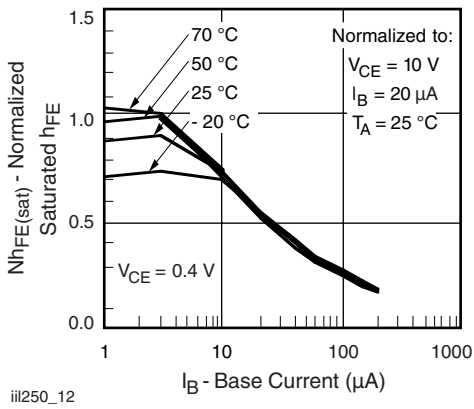

Fig. 12 - Normalized Saturated  $h_{FE}$  vs. Base Current and Temperature

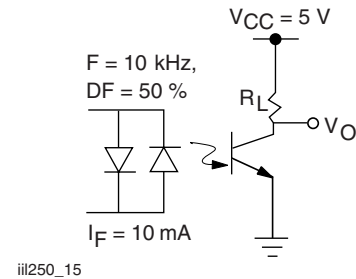

Fig. 15 - Switching Schematic

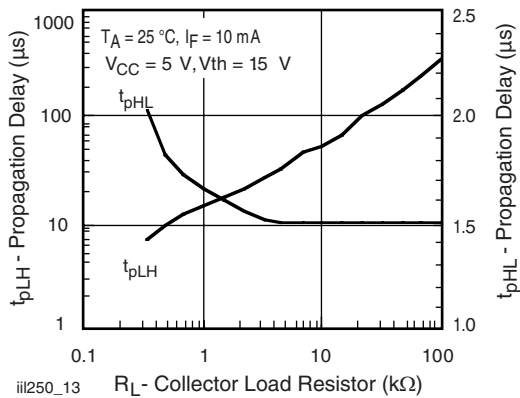

Fig. 13 - Propagation Delay vs. Collector Load Resistor

# IL250/251/252/ILD250/251/252



Vishay Semiconductors Optocoupler, Phototransistor Output,  
AC Input, with Base Connection

## PACKAGE DIMENSIONS in inches (millimeters)

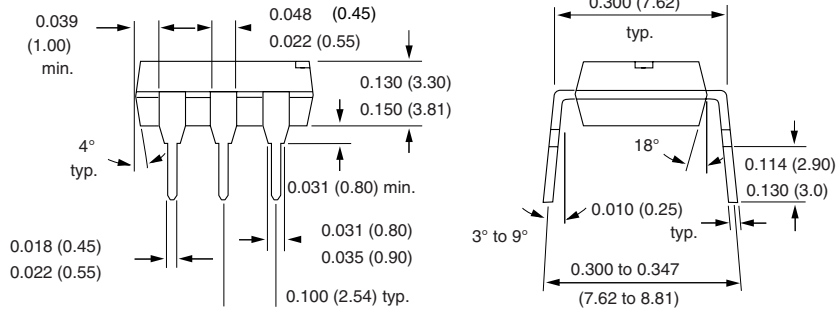
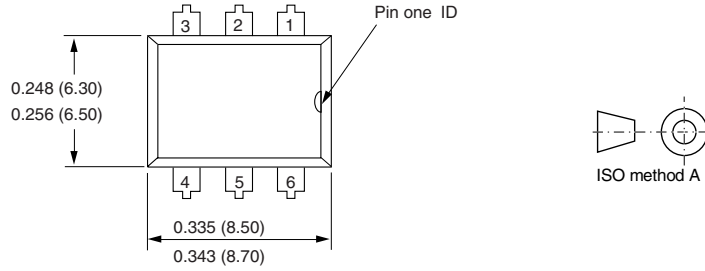

i178004

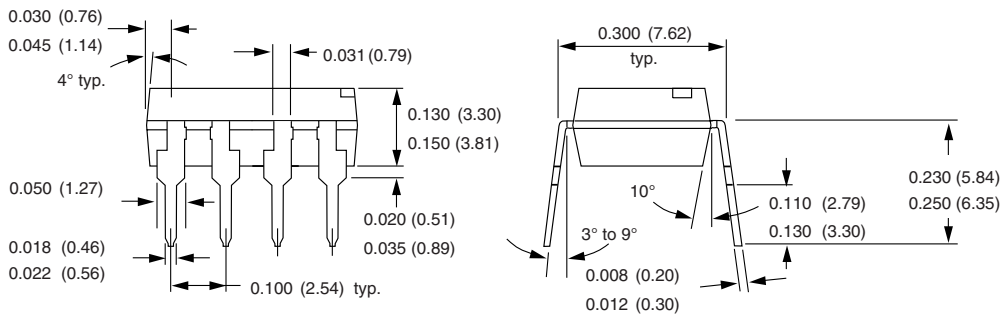
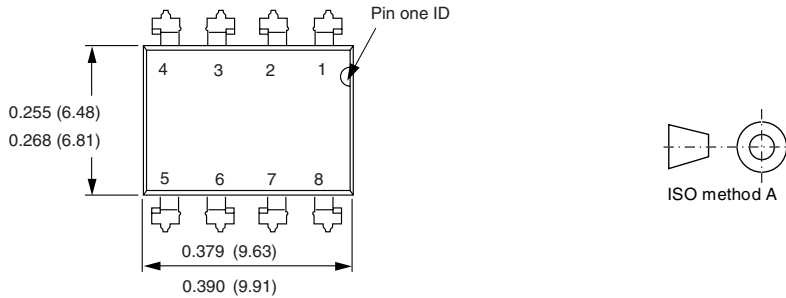

i178006

### Option 6

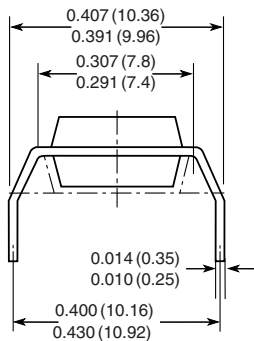

### Option 7

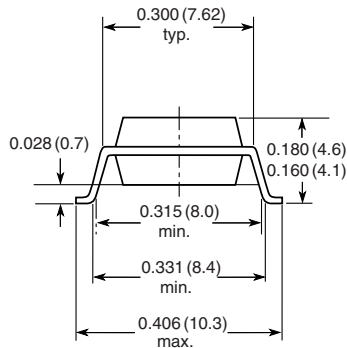

### Option 9

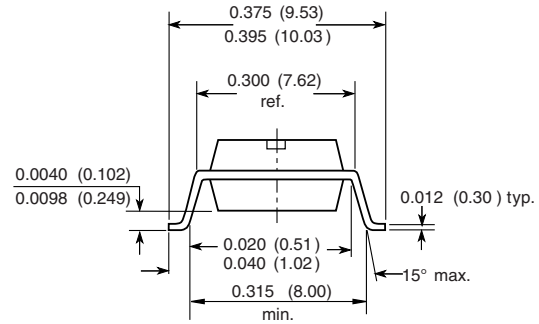

18450



**OZONE DEPLETING SUBSTANCES POLICY STATEMENT**

It is the policy of Vishay Semiconductor GmbH to

1. Meet all present and future national and international statutory requirements.
2. Regularly and continuously improve the performance of our products, processes, distribution and operating systems with respect to their impact on the health and safety of our employees and the public, as well as their impact on the environment.

It is particular concern to control or eliminate releases of those substances into the atmosphere which are known as ozone depleting substances (ODSs).

The Montreal Protocol (1987) and its London Amendments (1990) intend to severely restrict the use of ODSs and forbid their use within the next ten years. Various national and international initiatives are pressing for an earlier ban on these substances.

Vishay Semiconductor GmbH has been able to use its policy of continuous improvements to eliminate the use of ODSs listed in the following documents.

1. Annex A, B and list of transitional substances of the Montreal Protocol and the London Amendments respectively.
2. Class I and II ozone depleting substances in the Clean Air Act Amendments of 1990 by the Environmental Protection Agency (EPA) in the USA
3. Council Decision 88/540/EEC and 91/690/EEC Annex A, B and C (transitional substances) respectively.

Vishay Semiconductor GmbH can certify that our semiconductors are not manufactured with ozone depleting substances and do not contain such substances.

We reserve the right to make changes to improve technical design  
and may do so without further notice.

Parameters can vary in different applications. All operating parameters must be validated for each customer application by the customer. Should the buyer use Vishay Semiconductors products for any unintended or unauthorized application, the buyer shall indemnify Vishay Semiconductors against all claims, costs, damages, and expenses, arising out of, directly or indirectly, any claim of personal damage, injury or death associated with such unintended or unauthorized use.

Vishay Semiconductor GmbH, P.O.B. 3535, D-74025 Heilbronn, Germany



## Disclaimer

All product specifications and data are subject to change without notice.

Vishay Intertechnology, Inc., its affiliates, agents, and employees, and all persons acting on its or their behalf (collectively, "Vishay"), disclaim any and all liability for any errors, inaccuracies or incompleteness contained herein or in any other disclosure relating to any product.

Vishay disclaims any and all liability arising out of the use or application of any product described herein or of any information provided herein to the maximum extent permitted by law. The product specifications do not expand or otherwise modify Vishay's terms and conditions of purchase, including but not limited to the warranty expressed therein, which apply to these products.

No license, express or implied, by estoppel or otherwise, to any intellectual property rights is granted by this document or by any conduct of Vishay.

The products shown herein are not designed for use in medical, life-saving, or life-sustaining applications unless otherwise expressly indicated. Customers using or selling Vishay products not expressly indicated for use in such applications do so entirely at their own risk and agree to fully indemnify Vishay for any damages arising or resulting from such use or sale. Please contact authorized Vishay personnel to obtain written terms and conditions regarding products designed for such applications.

Product names and markings noted herein may be trademarks of their respective owners.





Компания «ЭлектроПласт» предлагает заключение долгосрочных отношений при поставках импортных электронных компонентов на взаимовыгодных условиях!

Наши преимущества:

- Оперативные поставки широкого спектра электронных компонентов отечественного и импортного производства напрямую от производителей и с крупнейших мировых складов;
- Поставка более 17-ти миллионов наименований электронных компонентов;
- Поставка сложных, дефицитных, либо снятых с производства позиций;
- Оперативные сроки поставки под заказ (от 5 рабочих дней);
- Экспресс доставка в любую точку России;
- Техническая поддержка проекта, помощь в подборе аналогов, поставка прототипов;
- Система менеджмента качества сертифицирована по Международному стандарту ISO 9001;
- Лицензия ФСБ на осуществление работ с использованием сведений, составляющих государственную тайну;
- Поставка специализированных компонентов (Xilinx, Altera, Analog Devices, Intersil, Interpoint, Microsemi, Aeroflex, Peregrine, Syfer, Eurofarad, Texas Instrument, Miteq, Cobham, E2V, MA-COM, Hittite, Mini-Circuits, General Dynamics и др.);

Помимо этого, одним из направлений компании «ЭлектроПласт» является направление «Источники питания». Мы предлагаем Вам помощь Конструкторского отдела:

- Подбор оптимального решения, техническое обоснование при выборе компонента;
- Подбор аналогов;
- Консультации по применению компонента;
- Поставка образцов и прототипов;
- Техническая поддержка проекта;
- Защита от снятия компонента с производства.



#### Как с нами связаться

**Телефон:** 8 (812) 309 58 32 (многоканальный)

**Факс:** 8 (812) 320-02-42

**Электронная почта:** [org@eplast1.ru](mailto:org@eplast1.ru)

**Адрес:** 198099, г. Санкт-Петербург, ул. Калинина, дом 2, корпус 4, литера А.