

# Chip Wire Wound Common Mode Choke

ACM-21



RoHS  
Compliant



2.0 x 1.2 x 1.2mm

## FEATURES:

- Small size with ferrite base
- Two line type wire wound
- High common-mode impedance at noise band and low differential-mode impedance at signal band
- Suitable for high-speed signal.

## APPLICATIONS:

- EMI and Noise Suppression
- USB Line Filter for Personal Computers and Peripheral
- IEEE 1394 Line for Personal Computers, DVC, STB
- Low-Voltage Differential Signal (LVDS) for LCD panels

## STANDARD SPECIFICATIONS

Abrakon P/N:	ACM-21
Operating Temperature & Humidity:	-40°C to +85°C
Storage Temperature & Humidity:	22°C to 28°C, Humidity < 80%RH (In tape and reel)

Part Number	Z	DCR	IDC	Rated Voltage	Withstanding Voltage	Insulation Resistance
Units	$\Omega \pm 20\%$	$\Omega$ (max.)	mA	Vdc	Vdc	M $\Omega$ (min.)
ACM-21-300	30	0.20	450	50	125	10
ACM-21-670	67	0.25	400	50	125	10
ACM-21-900	90	0.30	400	50	125	10
ACM-21-121	120	0.30	370	50	125	10
ACM-21-161	160	0.35	330	50	125	10
ACM-21-181	180	0.35	330	50	125	10
ACM-21-201	200	0.35	330	50	125	10
ACM-21-221	220	0.35	330	50	125	10
ACM-21-261	260	0.40	300	50	125	10
ACM-21-361	360	0.40	280	50	125	10
ACM-21-371	370	0.40	280	50	125	10

### Test Conditions

**Impedance:** LCR Meter HP 4291B, 100MHz

**DCR:** Micro-Ohm meter (GOM-801G)

**Withstand Voltage (VDC):** 125Vdc, 60 sec, 0.5mA

**Rated Voltage (VDC):** 50Vdc, 1 – 5 sec

**Insulation Resistance (I.R):** 1mA, 1 min

## PART IDENTIFICATION:

ACM-21 -  M -



### Impedance Code

Please refer to the table above

### Packaging

Blank: bulk  
T: Tape and Reel  
(2k pcs/reel)

# Chip Wire Wound Common Mode Choke

ACM-21



RoHS  
Compliant



2.0 x 1.2 x 1.2mm

## ELECTRICAL CHARACTERISTIC CURVE:

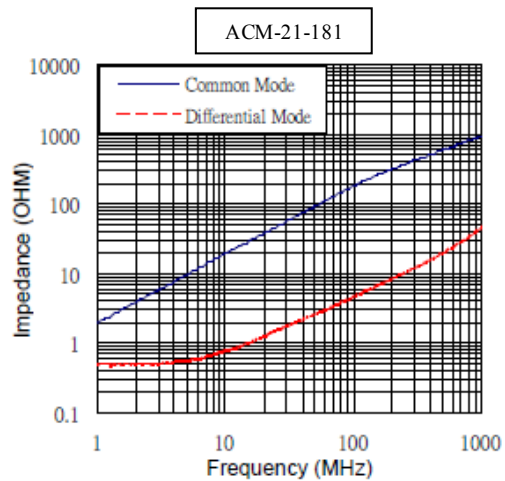
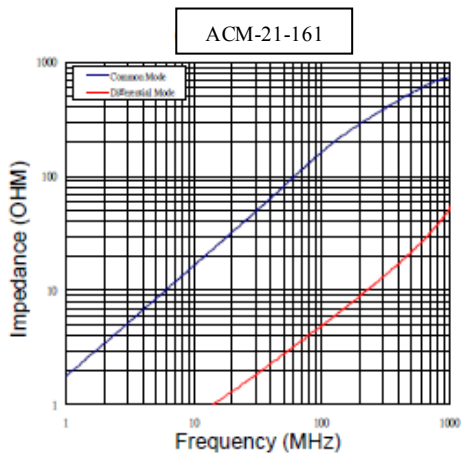
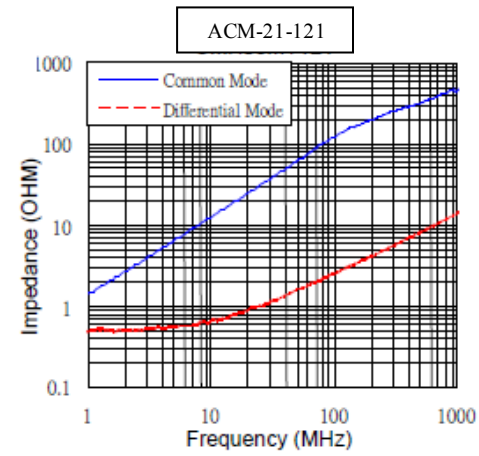
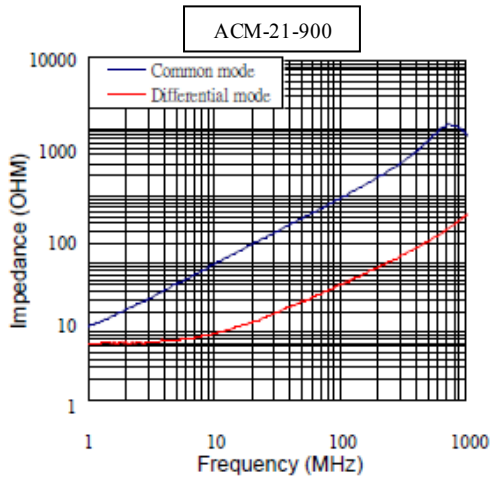
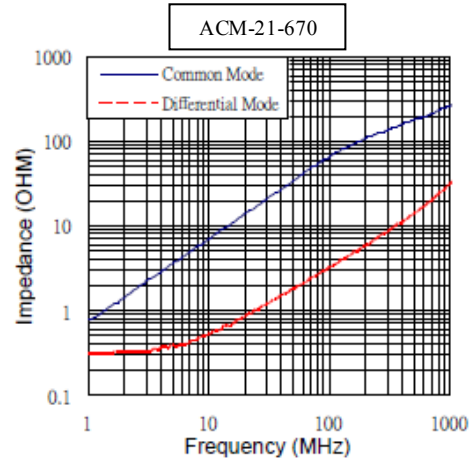

# Chip Wire Wound Common Mode Choke

ACM-21



RoHS  
Compliant



2.0 x 1.2 x 1.2mm

## ELECTRICAL CHARACTERISTIC CURVE:



# Chip Wire Wound Common Mode Choke

ACM-21



2.0 x 1.2 x 1.2mm

## OUTLINE DIMENSIONS:

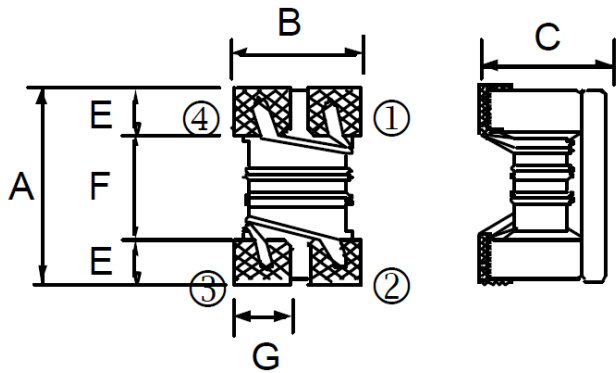

## Recommended Land Pattern

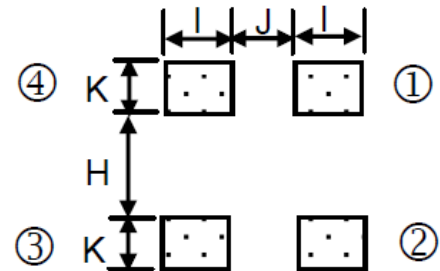

A	B	C	E	F	G
2.0±0.2	1.2±0.2	1.2±0.2	0.45	1.2	0.4

H	I	J	K
0.8	0.4	0.4	0.90

## Schematic

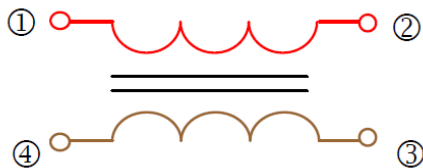

## REFLOW PROFILE:

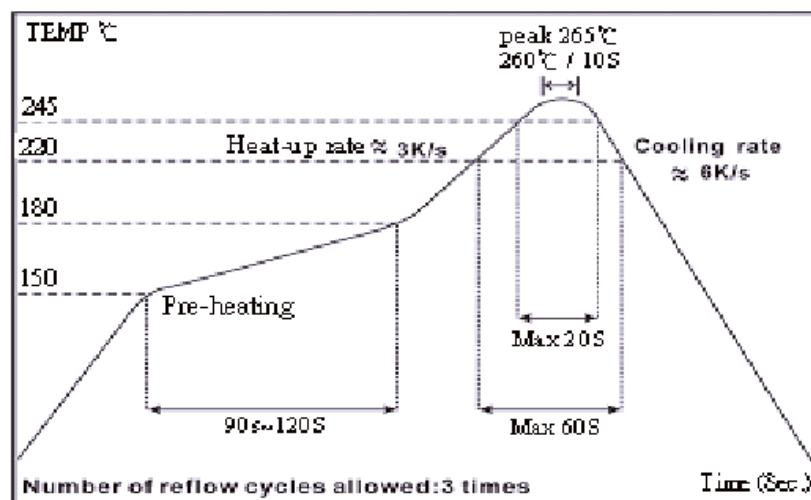

# Chip Wire Wound Common Mode Choke

ACM-21



2.0 x 1.2 x 1.2mm

TAPE & REEL: 2000pcs/reel



A	B	W	E	F	P0	P1	P2	ΦD0	t
1.40±0.10	2.55±0.05	8.0±0.20	1.75±0.10	3.5±0.10	4.00±0.10	4.00±0.10	2.00±0.10	1.50+0.10	1.35±0.10



ΦA	ΦB	ΦC	W	T
178±2.0	60±0.5	13±0.3	9+0.3	11.4±1.0

Dimension: mm

**ATTENTION:** Abracon Corporation's products are COTS – Commercial-Off-The-Shelf products; suitable for Commercial, Industrial and, where designated, Automotive Applications. Abracon's products are not specifically designed for Military, Aviation, Aerospace, Life-dependant Medical applications or any application requiring high reliability where component failure could result in loss of life and/or property. For applications requiring high reliability and/or presenting an extreme operating environment, written consent and authorization from Abracon Corporation is required. Please contact Abracon Corporation for more information.

ABRACON IS  
ISO 9001:2008  
CERTIFIED



Visit [www.abracon.com](http://www.abracon.com) for Terms & Conditions of Sale **Revised: 01.27.14**  
30332 Esperanza, Rancho Santa Margarita, California 92688  
tel 949-546-8000 | fax 949-546-8001 | [www.abracon.com](http://www.abracon.com)



Компания «ЭлектроПласт» предлагает заключение долгосрочных отношений при поставках импортных электронных компонентов на взаимовыгодных условиях!

Наши преимущества:

- Оперативные поставки широкого спектра электронных компонентов отечественного и импортного производства напрямую от производителей и с крупнейших мировых складов;
- Поставка более 17-ти миллионов наименований электронных компонентов;
- Поставка сложных, дефицитных, либо снятых с производства позиций;
- Оперативные сроки поставки под заказ (от 5 рабочих дней);
- Экспресс доставка в любую точку России;
- Техническая поддержка проекта, помощь в подборе аналогов, поставка прототипов;
- Система менеджмента качества сертифицирована по Международному стандарту ISO 9001;
- Лицензия ФСБ на осуществление работ с использованием сведений, составляющих государственную тайну;
- Поставка специализированных компонентов (Xilinx, Altera, Analog Devices, Intersil, Interpoint, Microsemi, Aeroflex, Peregrine, Syfer, Eurofarad, Texas Instrument, Miteq, Cobham, E2V, MA-COM, Hittite, Mini-Circuits, General Dynamics и др.);

Помимо этого, одним из направлений компании «ЭлектроПласт» является направление «Источники питания». Мы предлагаем Вам помощь Конструкторского отдела:

- Подбор оптимального решения, техническое обоснование при выборе компонента;
- Подбор аналогов;
- Консультации по применению компонента;
- Поставка образцов и прототипов;
- Техническая поддержка проекта;
- Защита от снятия компонента с производства.



#### Как с нами связаться

**Телефон:** 8 (812) 309 58 32 (многоканальный)

**Факс:** 8 (812) 320-02-42

**Электронная почта:** [org@eplast1.ru](mailto:org@eplast1.ru)

**Адрес:** 198099, г. Санкт-Петербург, ул. Калинина, дом 2, корпус 4, литера А.