

# MAX5395

## Single, 256-Tap Volatile, I<sup>2</sup>C, Low-Voltage Linear Taper Digital Potentiometer

### General Description

The MAX5395 single, 256-tap volatile, low-voltage linear taper digital potentiometer offers three end-to-end resistance values of 10kΩ, 50kΩ, and 100kΩ. Potentiometer terminals are independent of supply for voltages up to 5.25V with single-supply operation from 1.7V to 5.5V (charge pump enabled). User-controlled shutdown modes allow the H, W, or L terminal to be opened with the wiper position set to zero-code, mid-code, full-code, or the value contained in the wiper register. Ultra-low-quiescent supply current (< 1μA) can be achieved for supply voltages between 2.6V and 5.5V by disabling the internal charge pump and not allowing potentiometer terminals to exceed the supply voltage by more than 0.3V. The MAX5395 provides a low 50ppm/°C end-to-end temperature coefficient and features an I<sup>2</sup>C serial interface.

The small package size, low operating supply voltage, low supply current, and automotive temperature range of the MAX5395 make the device uniquely suited for the portable consumer market, battery-backup industrial applications, and automotive market.

The MAX5395 is available in a lead-free, 8-pin TDFN (2mm x 2mm) package. The device operates over the -40°C to +125°C automotive temperature range.

**Ordering Information** appears at end of data sheet.

### Features

- ◆ Single Linear Taper 256-Tap Positions
- ◆ 10kΩ, 50kΩ, and 100kΩ End-to-End Resistance
- ◆ 1.7V to 5.5V Extended Single Supply
- ◆ 0 to 5.25V H, W, L Operating Voltage Independent of V<sub>DD</sub>
- ◆ 1μA (typ) Supply Current in Low-Power Mode
- ◆ ±1.0 LSB INL, ±0.5 LSB DNL (max) Wiper Accuracy
- ◆ Power-On Sets Wiper to Midscale
- ◆ 50ppm/°C End-to-End Temperature Coefficient
- ◆ 5ppm/°C Ratiometric Temperature Coefficient
- ◆ -40°C to +125°C Operating Temperature Range
- ◆ 2mm x 2mm, 8-Pin TDFN Package
- ◆ I<sup>2</sup>C-Compatible Serial Interface

### Applications

Portable Electronics  
 System Calibration  
 Battery-Powered Systems  
 Automotive Electronics  
 Mechanical Potentiometer Replacement

### Typical Operating Circuit

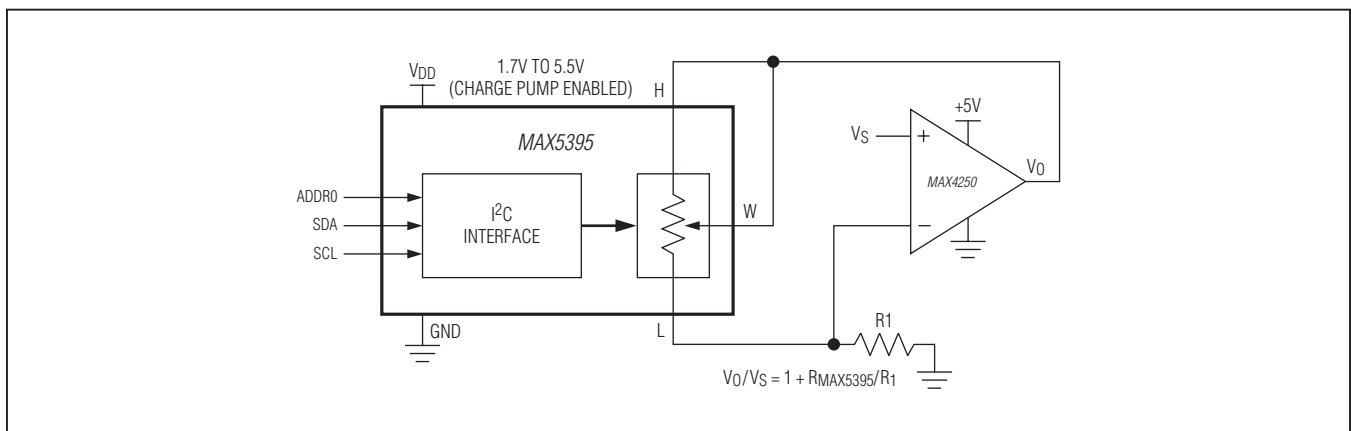

For related parts and recommended products to use with this part, refer to: [www.maximintegrated.com/MAX5395.related](http://www.maximintegrated.com/MAX5395.related)

**For pricing, delivery, and ordering information, please contact Maxim Direct at 1-888-629-4642, or visit Maxim's website at [www.maximintegrated.com](http://www.maximintegrated.com).**

# MAX5395

## Single, 256-Tap Volatile, I<sup>2</sup>C, Low-Voltage Linear Taper Digital Potentiometer

### ABSOLUTE MAXIMUM RATINGS

(All voltages referenced to GND.)

V <sub>DD</sub> .....	-0.3V to +6V
H, W, L (charge pump enabled) .....	-0.3V to +5.5V
H, W, L (charge pump disabled) .....	-0.3V to the lower of (V <sub>DD</sub> + 0.3V) or +6V
ADDR0 .....	-0.3V to the lower of (V <sub>DD</sub> + 0.3V) or +6V
All Other Pins .....	-0.3V to +6V
Continuous Current into H, W, and L	
MAX5395L .....	5mA
MAX5395M .....	2mA

MAX5395N .....	1mA
Maximum Current into Any Input .....	50mA
Continuous Power Dissipation (T <sub>A</sub> = +70°C)	
TDFN (derate 11.9mW/°C above +70°C) .....	953.5mW
Operating Temperature Range .....	-40°C to +125°C
Storage Temperature Range .....	-65°C to +150°C
Junction Temperature .....	+150°C
Lead Temperature (soldering, 10s) .....	+300°C
Soldering Temperature (reflow) .....	+260°C

Stresses beyond those listed under "Absolute Maximum Ratings" may cause permanent damage to the device. These are stress ratings only, and functional operation of the device at these or any other conditions beyond those indicated in the operational sections of the specifications is not implied. Exposure to absolute maximum rating conditions for extended periods may affect device reliability.

### PACKAGE THERMAL CHARACTERISTICS (Note 1)

TDFN

Junction-to-Ambient Thermal Resistance (θ <sub>JA</sub> ) .....	83.9°C/W
Junction-to-Case Thermal Resistance (θ <sub>JC</sub> ) .....	37.0°C/W

**Note 1:** Package thermal resistances were obtained using the method described in JEDEC specification JESD51-7, using a four-layer board. For detailed information on package thermal considerations, refer to [www.maximintegrated.com/thermal-tutorial](http://www.maximintegrated.com/thermal-tutorial).

### ELECTRICAL CHARACTERISTICS

(V<sub>DD</sub> = 1.7V to 5.5V, V<sub>H</sub> = V<sub>DD</sub>, V<sub>L</sub> = GND, T<sub>A</sub> = -40°C to +125°C, unless otherwise noted. Typical values are at V<sub>DD</sub> = 1.8V, T<sub>A</sub> = +25°C.) (Note 2)

PARAMETER	SYMBOL	CONDITIONS	MIN	TYP	MAX	UNITS
<b>RESOLUTION</b>						
256-Tap Family	N		256			Tap
<b>DC PERFORMANCE (Voltage-Divider Mode)</b>						
Integral Nonlinearity (Note 3)	INL		-1.0		+1.0	LSB
Differential Nonlinearity	DNL	(Note 3)	-0.5		+0.5	LSB
Ratiometric Resistor Tempco		(DV <sub>W</sub> /V <sub>W</sub> )/DT, V <sub>H</sub> = V <sub>DD</sub> , V <sub>L</sub> = GND, No Load		5		ppm/°C
Full-Scale Error (Code FFh)		Charge pump enabled, 1.7V < V <sub>DD</sub> < 5.5V	-0.5			LSB
		Charge pump disabled, 2.6V < V <sub>DD</sub> < 5.5V	MAX5395M	-0.5		
			MAX5395L	-1.0		
Zero-Scale Error (Code 00h)		Charge pump enabled, 1.7V < V <sub>DD</sub> < 5.5V			+0.5	LSB
		Charge pump disabled, 2.6V < V <sub>DD</sub> < 5.5V	MAX5395M		+0.5	
			MAX5395L		+1.0	
<b>DC PERFORMANCE (Variable Resistor Mode)</b>						
Integral Nonlinearity (Note 4)	R-INL	Charge pump enabled, 1.7V < V <sub>DD</sub> < 5.5V	-1.0		+1.0	LSB
		Charge pump disabled, 2.6V < V <sub>DD</sub> < 5.5V	MAX5395M	-1.0	+1.0	
			MAX5395L	-1.5	+1.5	
Differential Nonlinearity	R-DNL	(Note 4)	-0.5		+0.5	LSB
Wiper Resistance (Note 5)	R <sub>WL</sub>	Charge pump enabled, 1.7V < V <sub>DD</sub> < 5.5V		25	50	Ω
		Charge pump disabled, 2.6V < V <sub>DD</sub> < 5.5V			200	

# MAX5395

## Single, 256-Tap Volatile, I<sup>2</sup>C, Low-Voltage Linear Taper Digital Potentiometer

### ELECTRICAL CHARACTERISTICS (continued)

(V<sub>DD</sub> = 1.7V to 5.5V, V<sub>H</sub> = V<sub>DD</sub>, V<sub>L</sub> = GND, T<sub>A</sub> = -40°C to +125°C, unless otherwise noted. Typical values are at V<sub>DD</sub> = 1.8V, T<sub>A</sub> = +25°C.) (Note 2)

PARAMETER	SYMBOL	CONDITIONS	MIN	TYP	MAX	UNITS	
<b>DC PERFORMANCE (Resistor Characteristics)</b>							
Terminal Capacitance	C <sub>H</sub> , C <sub>L</sub>	Measured to GND		10		pF	
Wiper Capacitance	C <sub>W</sub>	Measured to GND		20		pF	
End-to-End Resistor Tempco	T <sub>CR</sub>	No load		50		ppm/°C	
End-to-End Resistor Tolerance		Wiper not connected	-25		+25	%	
<b>AC PERFORMANCE</b>							
-3dB Bandwidth	BW	Code = 80h, 10pF load, V <sub>DD</sub> = 1.8V	10kΩ	1600		kHz	
			50kΩ	340			
			100kΩ	165			
Total Harmonic Distortion Plus Noise	THD+N	(Note 6)		0.035		%	
Wiper Settling Time	t <sub>S</sub>	(Note 7)	10kΩ	190		ns	
			50kΩ	400			
			100kΩ	664			
Charge-Pump Feedthrough at W	V <sub>RW</sub>			600		nV <sub>RMS</sub>	
<b>POWER SUPPLIES</b>							
Supply Voltage Range	V <sub>DD</sub>		1.7		5.5	V	
Terminal Voltage Range (H, W, L to GND)		Charge pump enabled, 1.7V < V <sub>DD</sub> < 5.5V	0		5.25	V	
		Charge pump disabled, 2.6V < V <sub>DD</sub> < 5.5V	0		V <sub>DD</sub>		
Supply Current (Note 8)	I <sub>VDD</sub>	Charge pump disabled, 2.6V < V <sub>DD</sub> < 5.5V		1		μA	
		Charge pump enabled, 1.7V < V <sub>DD</sub> < 5.5V	V <sub>DD</sub> = 5.5V		25		
			V <sub>DD</sub> = 1.7V		20		
<b>DIGITAL INPUTS</b>							
Minimum Input High Voltage	V <sub>IH</sub>	2.6V < V <sub>DD</sub> < 5.5V	70			% x V <sub>DD</sub>	
		1.7V < V <sub>DD</sub> < 2.6V	80				
Maximum Input Low Voltage	V <sub>IL</sub>	2.6V < V <sub>DD</sub> < 5.5V			30	% x V <sub>DD</sub>	
		1.7V < V <sub>DD</sub> < 2.6V			20		
Input Leakage Current			-1		+1	μA	
Input Capacitance				5		pF	
ADDR0 Pullup/Pulldown Strength	R <sub>PURRPD</sub>	(Note 9)		60		kΩ	
<b>TIMING CHARACTERISTICS (Note 10)</b>							
Maximum SCL Frequency	f <sub>SCL</sub>				400	kHz	
Setup Time for START Condition	t <sub>SU:STA</sub>		0.6			μs	

# MAX5395

## Single, 256-Tap Volatile, I<sup>2</sup>C, Low-Voltage Linear Taper Digital Potentiometer

### ELECTRICAL CHARACTERISTICS (continued)

(V<sub>DD</sub> = 1.7V to 5.5V, V<sub>H</sub> = V<sub>DD</sub>, V<sub>L</sub> = GND, T<sub>A</sub> = -40°C to +125°C, unless otherwise noted. Typical values are at V<sub>DD</sub> = 1.8V, T<sub>A</sub> = +25°C.) (Note 2)

PARAMETER	SYMBOL	CONDITIONS	MIN	TYP	MAX	UNITS
Hold Time for START Condition	t <sub>HD:STA</sub>		0.6			μs
SCL High Time	t <sub>HIGH</sub>		0.6			μs
SCL Low Time	t <sub>LOW</sub>		1.3			μs
Data Setup Time	t <sub>SU:DAT</sub>		100			ns
Data Hold Time	t <sub>HD:DAT</sub>		0			μs
SDA, SCL Rise Time	t <sub>R</sub>				0.3	μs
SDA, SCL Fall Time	t <sub>F</sub>				0.3	μs
Setup Time for STOP Conditions	t <sub>SU:STO</sub>		0.6			μs
Bus Free Time Between STOP and START Conditions	t <sub>BUF</sub>		1.3			μs
Pulse-Suppressed Spike Width	t <sub>SP</sub>			50		ns
Capacitive Load for Each Bus	C <sub>B</sub>			400		pF

**Note 2:** All devices are production tested at T<sub>A</sub> = +25°C and are guaranteed by design and characterization for T<sub>A</sub> = -40°C to +125°C.

**Note 3:** DNL and INL are measured with the potentiometer configured as a voltage-divider with V<sub>H</sub> = 5.25V (QP enabled) or V<sub>DD</sub> (QP disabled) and V<sub>L</sub> = GND. The wiper terminal is unloaded and measured with an ideal voltmeter.

**Note 4:** R-DNL and R-INL are measured with the potentiometer configured as a variable resistor (Figure 1). H is unconnected and L = GND.

For charge pump enabled, V<sub>DD</sub> = 1.7V to 5.5V, the wiper terminal is driven with a source current of 400μA for the 10kΩ configuration, 80μA for the 50kΩ configuration, and 40μA for the 100kΩ configuration.

For charge pump disabled and V<sub>DD</sub> = 5.5V, the wiper terminal is driven with a source current of 400μA for the 10kΩ configuration, 80μA for the 50kΩ configuration, and 40μA for the 100kΩ configuration.

For charge pump disabled and V<sub>DD</sub> = 2.6V, the wiper terminal is driven with a source current of 200μA for the 10kΩ configuration, 40μA for the 50kΩ configuration, and 20μA for the 100kΩ configuration.

**Note 5:** The wiper resistance is the maximum value measured by injecting the currents given in Note 4 into W with L = GND.  
 $R_W = (V_W - V_H)/I_W$ .

**Note 6:** Measured at W with H driven with a 1kHz, 0V to V<sub>DD</sub> amplitude tone and V<sub>L</sub> = GND. Wiper at midscale with a 10pF load.

**Note 7:** Wiper-settling time is the worst-case 0-to-50% rise time, measured between tap 0 and tap 127. H = V<sub>DD</sub>, L = GND, and the wiper terminal is loaded with 10pF capacitance to ground.

**Note 8:** Digital Inputs at V<sub>DD</sub> or GND.

**Note 9:** An unconnected condition on the ADDR0 pin is sensed via a pullup and pulldown operation. For proper operation, the ADDR0 pin should be tied to V<sub>DD</sub>, GND, or left unconnected with minimal capacitance.

**Note 10:** Digital timing is guaranteed by design and characterization, and is not production tested.

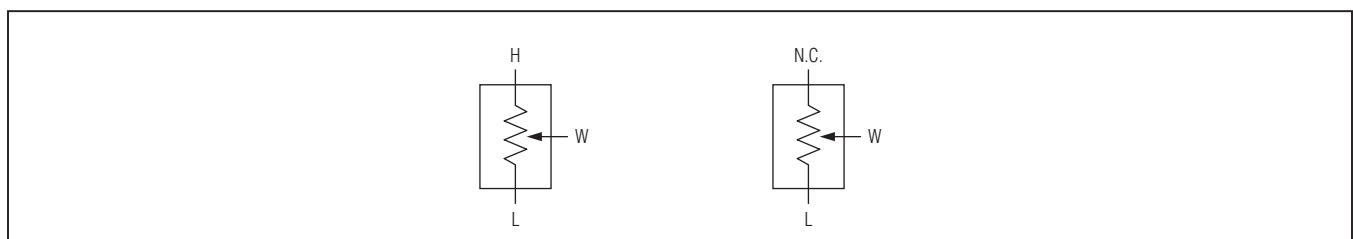

Figure 1. Voltage-Divider and Variable Resistor Configurations

# MAX5395

## Single, 256-Tap Volatile, I<sup>2</sup>C, Low-Voltage Linear Taper Digital Potentiometer

### Typical Operating Characteristics

( $V_{DD} = 2.5V$ ,  $T_A$  unless otherwise noted.)

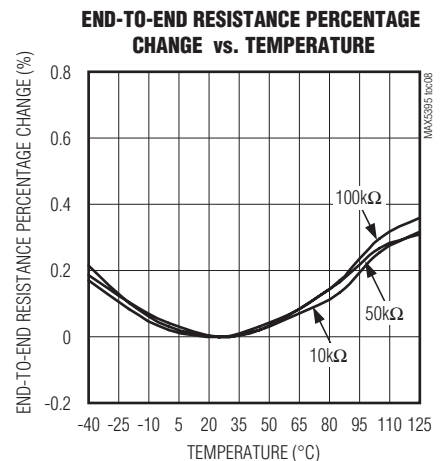
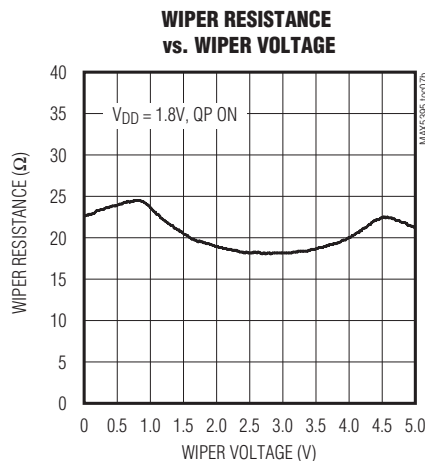
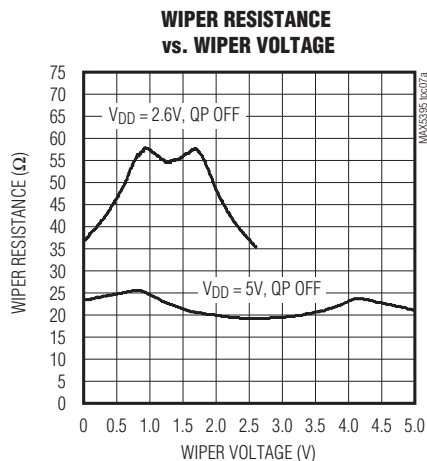
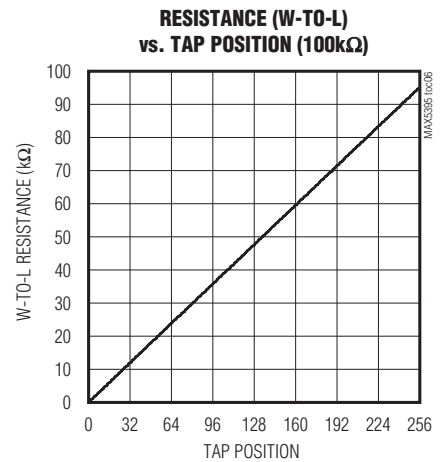
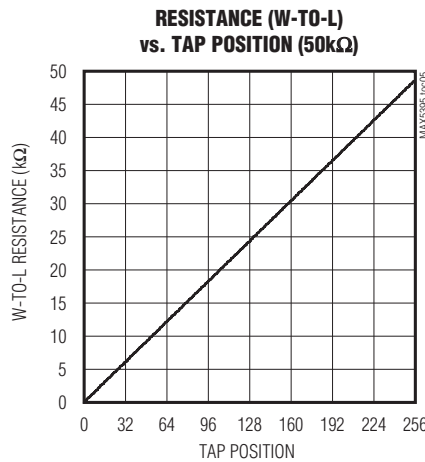
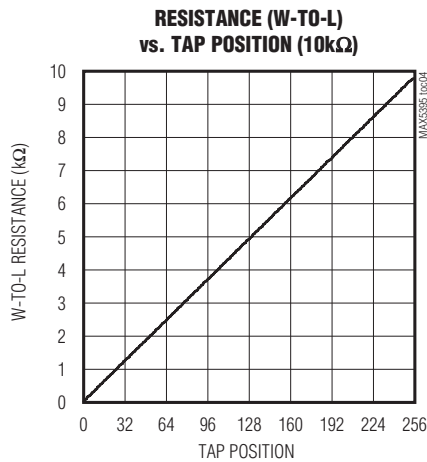
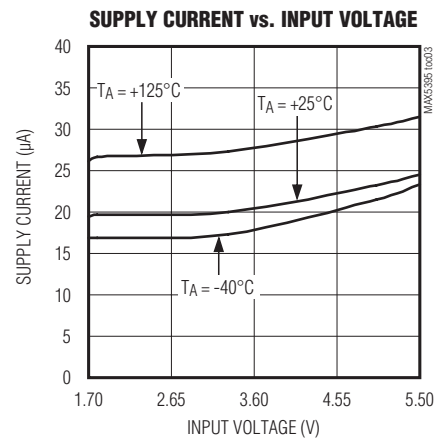
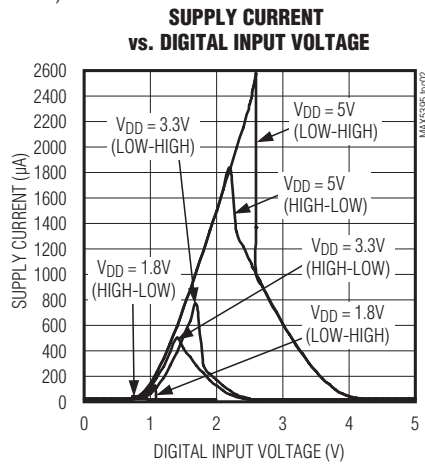
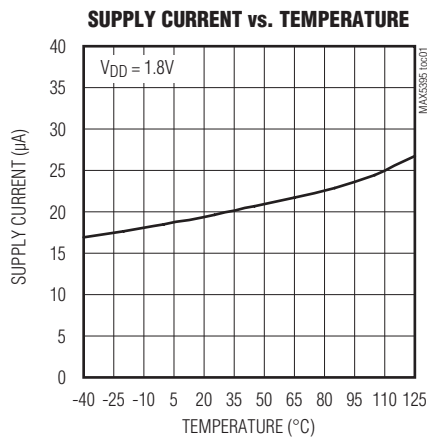

# MAX5395

## Single, 256-Tap Volatile, I<sup>2</sup>C, Low-Voltage Linear Taper Digital Potentiometer

### Typical Operating Characteristics (continued)

(V<sub>DD</sub> = 1.8V, T<sub>A</sub> = +25°C, unless otherwise noted.)

**TAP-TO-TAP SWITCHING TRANSIENT  
(CODE 127 TO 128, 10kΩ)**

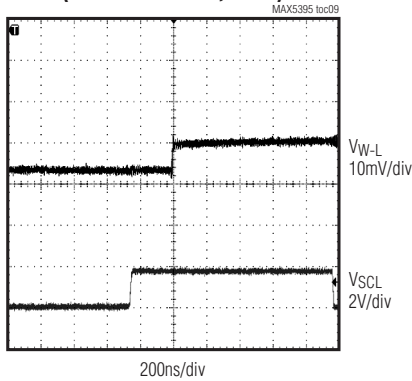

**TAP-TO-TAP SWITCHING TRANSIENT  
(CODE 127 TO 128, 50kΩ)**

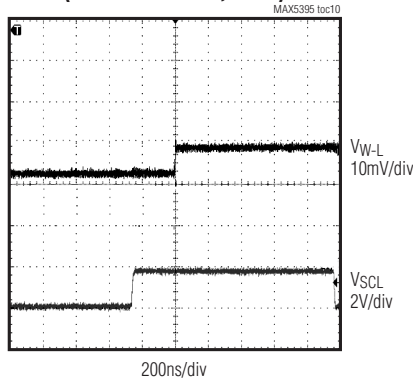

**TAP-TO-TAP SWITCHING TRANSIENT  
(CODE 127 TO 128, 100kΩ)**

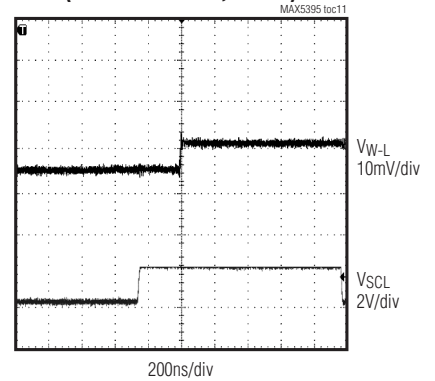

**POWER-ON TRANSIENT (10kΩ)**

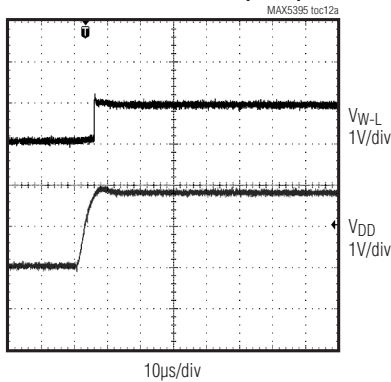

**POWER-ON TRANSIENT (50kΩ)**

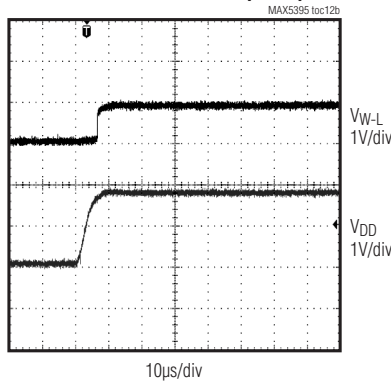

**POWER-ON TRANSIENT (100kΩ)**

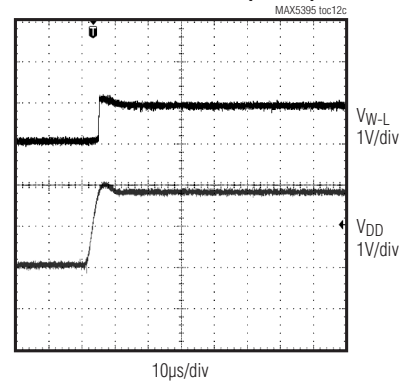

**MIDSCALE FREQUENCY  
RESPONSE (10kΩ)**

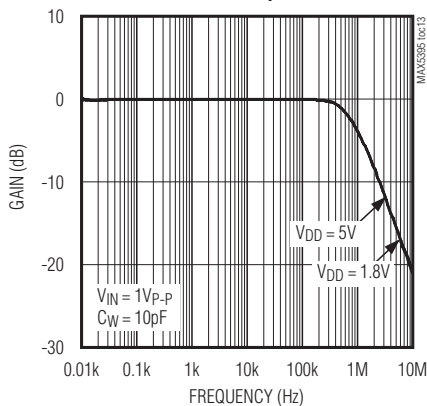

**MIDSCALE FREQUENCY  
RESPONSE (50kΩ)**

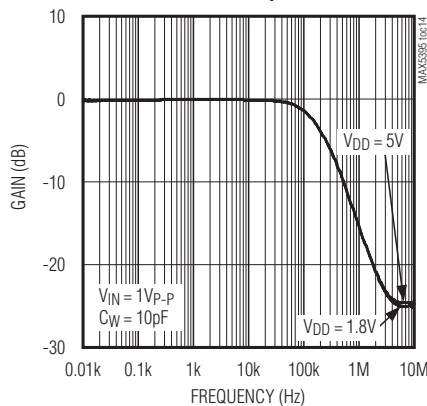

**MIDSCALE FREQUENCY  
RESPONSE (100kΩ)**

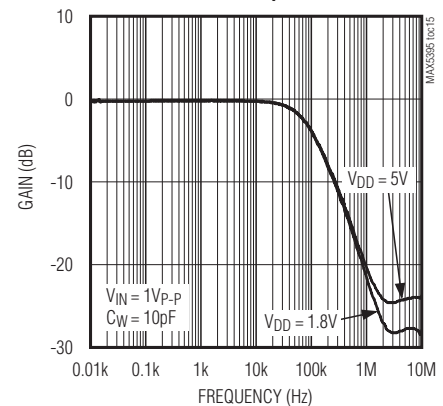

# MAX5395

## Single, 256-Tap Volatile, I<sup>2</sup>C, Low-Voltage Linear Taper Digital Potentiometer

### Typical Operating Characteristics (continued)

(V<sub>DD</sub> = 1.8V, T<sub>A</sub> = +25°C, unless otherwise noted.)

**TOTAL HARMONIC DISTORTION PLUS NOISE vs. FREQUENCY**

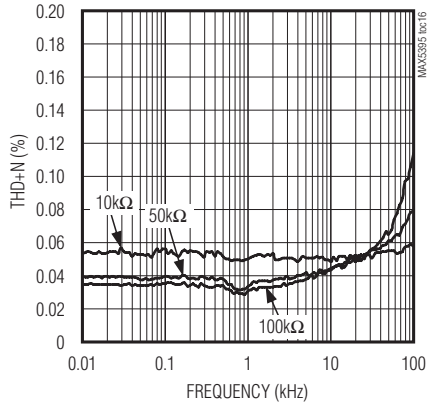

**CHARGE-PUMP FEEDTHROUGH AT W**

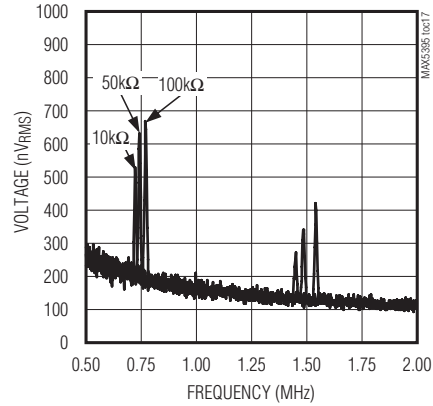

**VARIABLE-RESISTOR DNL vs. TAP POSITION (10kΩ)**

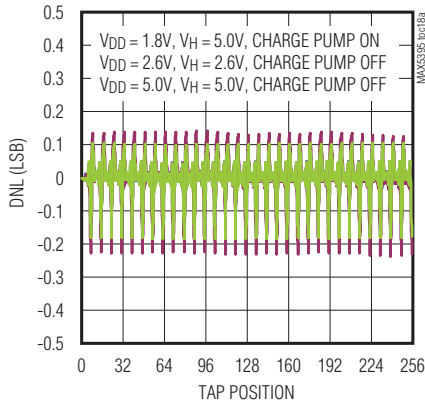

**VARIABLE-RESISTOR DNL vs. TAP POSITION (50kΩ)**

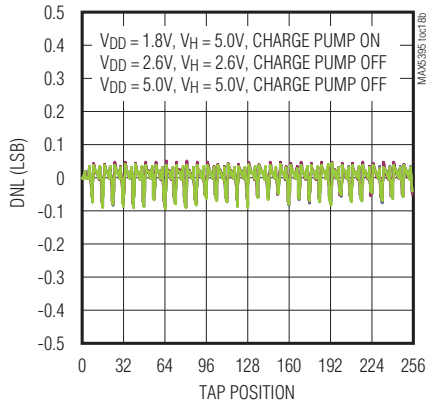

**VARIABLE-RESISTOR DNL vs. TAP POSITION (100kΩ)**

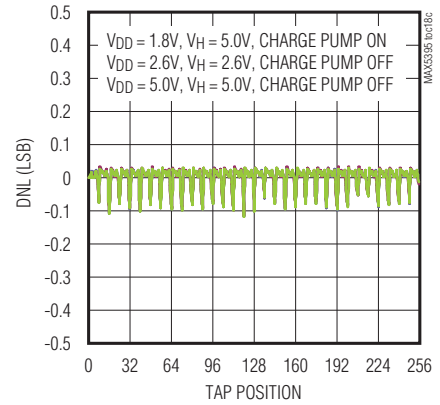

**VARIABLE-RESISTOR INL vs. TAP POSITION (10kΩ)**

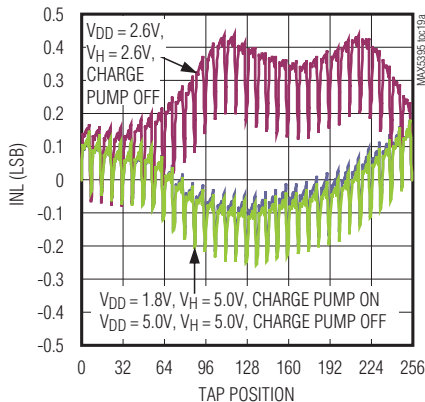

**VARIABLE-RESISTOR INL vs. TAP POSITION (50kΩ)**

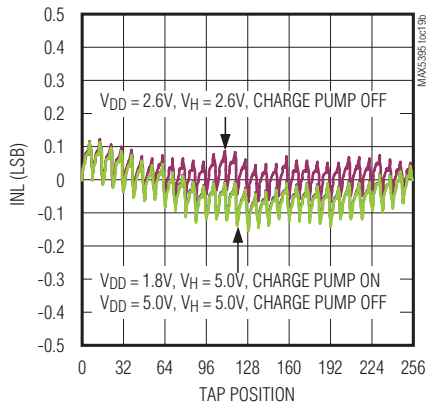

**VARIABLE-RESISTOR INL vs. TAP POSITION (100kΩ)**

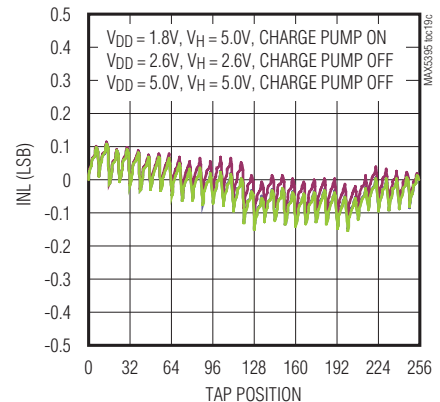

# MAX5395

## Single, 256-Tap Volatile, I<sup>2</sup>C, Low-Voltage Linear Taper Digital Potentiometer

### Typical Operating Characteristics (continued)

( $V_{DD} = 1.8V$ ,  $T_A = +25^\circ C$ , unless otherwise noted.)

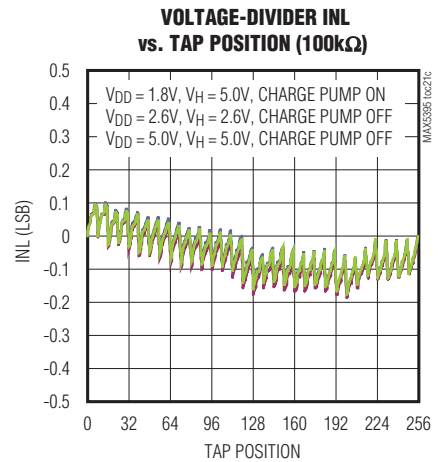
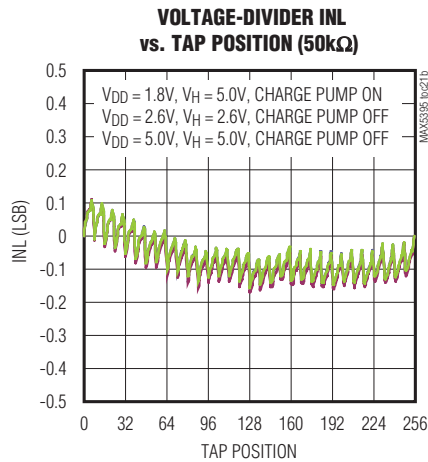
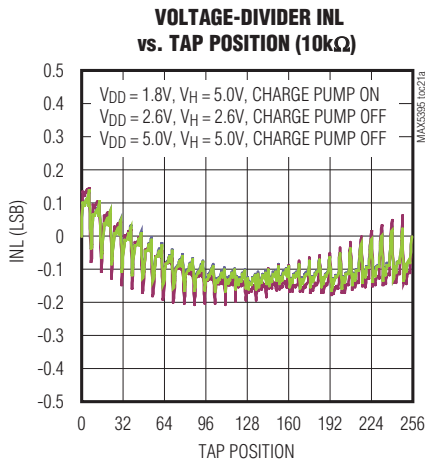
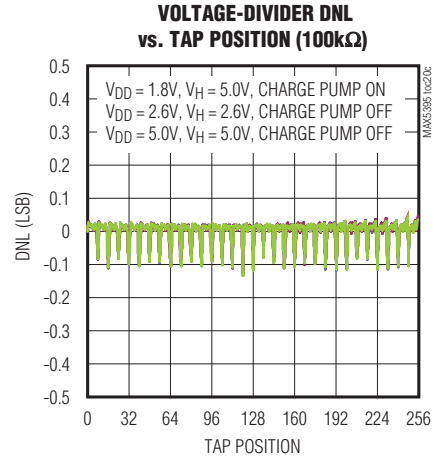
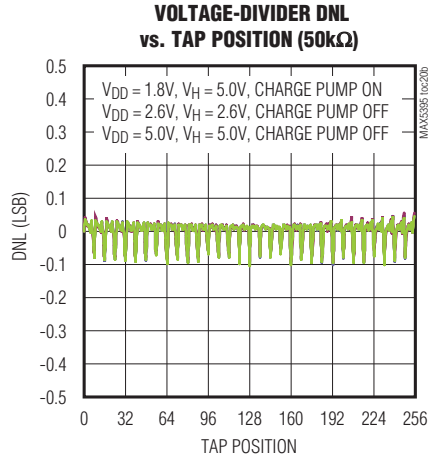
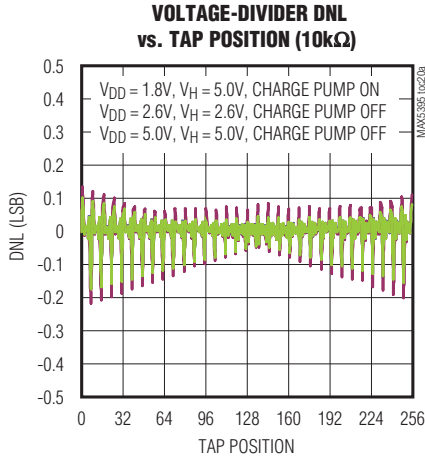



# MAX5395

## Single, 256-Tap Volatile, I<sup>2</sup>C, Low-Voltage Linear Taper Digital Potentiometer

### *Pin Configuration*

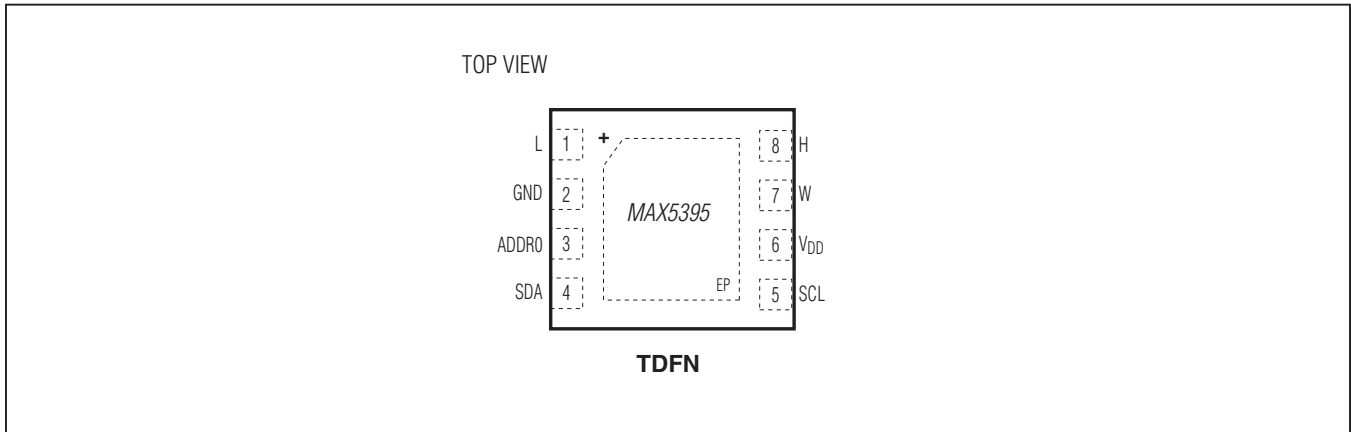

### *Pin Description*

PIN	NAME	FUNCTION
1	L	Low Terminal. The voltage at L can be greater than or less than the voltage at H. Current can flow into or out of L.
2	GND	Ground
3	ADDR0	Address Input 0. Connected to V <sub>DD</sub> , GND, or open.
4	SDA	I <sup>2</sup> C Serial Data Input
5	SCL	I <sup>2</sup> C Clock Input
6	V <sub>DD</sub>	Power Supply
7	W	Wiper Terminal
8	H	High Terminal. The voltage at H can be greater than or less than the voltage at L. Current can flow into or out of H.
—	EP	Exposed Pad. Internally connected to GND. Connect to ground.

# MAX5395

## Single, 256-Tap Volatile, I<sup>2</sup>C, Low-Voltage Linear Taper Digital Potentiometer

### Functional Diagram

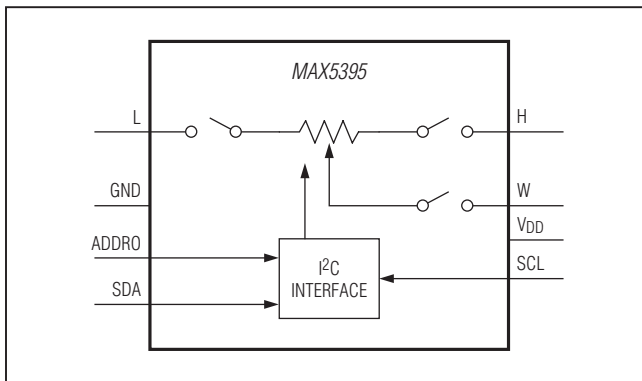

### Detailed Description

The MAX5395 single, 256-tap volatile, low-voltage linear taper digital potentiometer offers three end-to-end resistance values of 10k $\Omega$ , 50k $\Omega$ , and 100k $\Omega$ . Potentiometer terminals are independent of supply for voltages up to +5.25V with single-supply operation from 1.7V to 5.5V (charge pump enabled). User-controlled shutdown modes allow the H, W, or L terminals to be opened with the wiper position set to zero-code, midcode, full-code, or the value contained in the wiper register. Ultra-low-quiescent supply current (< 1 $\mu$ A) can be achieved for supply voltages between 2.6V and 5.5V by disabling the internal charge pump and not allowing potentiometer terminals to exceed the supply voltage by more than 0.3V. The MAX5395 provides a low 50ppm/ $^{\circ}$ C end-to-end temperature coefficient and features a I<sup>2</sup>C serial interface.

The small package size, low supply operating voltage, low supply current, and automotive temperature range of the MAX5395 make the device uniquely suited for the portable consumer market, battery-backup industrial applications, and automotive market.

#### Charge Pump

The MAX5395 contains an internal charge pump that guarantees the maximum wiper resistance,  $R_{WL}$ , to be less than 50 $\Omega$  (25 $\Omega$  typ) for supply voltages down to 1.7V and allows pins H, W, and L to be driven between GND and 5.25V independent of  $V_{DD}$ . Minimal charge-pump feedthrough is present at the terminal outputs and is illustrated by the Charge-Pump Feedthrough at W vs. Frequency graph in the [Typical Operating](#)

[Characteristics](#). The charge pump is on by default but can be disabled with QP\_OFF and enabled with the QP\_ON commands ([Table 1](#)). The MAX5395 minimum supply voltage with charge pump disabled is limited to 2.6V and terminal voltage cannot exceed -0.3V to ( $V_{DD} + 0.3V$ ).

#### I<sup>2</sup>C Interface

The MAX5395 feature an I<sup>2</sup>C/SMBus-compatible, 2-wire serial interface consisting of a serial data line (SDA) and a serial clock line (SCL). SDA and SCL enable communication between the MAX5395 and the master at clock rates up to 400kHz. [Figure 1](#) shows the 2-wire interface timing diagram. The master generates SCL and initiates data transfer on the bus. The master device writes data to the MAX5395 by transmitting the proper slave address followed by the command byte and then the data word. Each transmit sequence is framed by a START (S) or Repeated START (Sr) condition and a STOP (P) condition. Each word transmitted to the MAX5395 is 8 bits long and is followed by an acknowledge clock pulse. A master reading data from the MAX5395 must transmit the proper slave address followed by a series of nine SCL pulses for each byte of data requested. The MAX5395 transmit data on SDA in sync with the master-generated SCL pulses. The master acknowledges receipt of each byte of data. Each read sequence is framed by a START or Repeated START condition, a not acknowledge, and a STOP condition. SDA operates as both an input and an open-drain output. A pullup resistor, typically 4.7k $\Omega$ , is required on SDA. SCL operates only as an input. A pullup resistor, typically 4.7k $\Omega$ , is required on SCL if there are multiple masters on the bus, or if the single master has an open-drain SCL output.

Series resistors in line with SDA and SCL are optional. Series resistors protect the digital inputs of the MAX5395 from high voltage spikes on the bus lines and minimize crosstalk and undershoot of the bus signals. The MAX5395 can accommodate bus voltages higher than  $V_{DD}$  up to a limit of +5.5V. Bus voltages lower than  $V_{DD}$  are not recommended and may result in significantly increased interface currents and data corruption.

The MAX5395 with I<sup>2</sup>C interface contains a shift register that decodes the command and address bytes, routing the data to the register. Data written to a memory register immediately updates the wiper position. The wiper powers up in mid position,  $D[7:0] = 0x80$  with charge pump enabled.

# MAX5395

## Single, 256-Tap Volatile, I<sup>2</sup>C, Low-Voltage Linear Taper Digital Potentiometer

### I<sup>2</sup>C START and STOP Conditions

SDA and SCL idle high when the bus is not in use. A master initiates communication by issuing a START condition. A START condition is a high-to-low transition on SDA with SCL high. A STOP condition is a low-to-high transition on SDA while SCL is high (Figure 2). A START condition from the master signals the beginning of a transmission to the MAX5395. The master terminates transmission and frees the bus, by issuing a STOP condition. The bus remains active if a Repeated START condition is generated instead of a STOP condition.

### I<sup>2</sup>C Early STOP and Repeated START Conditions

The MAX5395 recognizes a STOP condition at any point during data transmission except if the STOP condition occurs in the same high pulse as a START condition. For proper operation, do not send a STOP condition during the same SCL high pulse as the START condition. Transmissions ending in an early STOP condition will not impact the internal device settings. If the STOP occurs during a readback byte, the transmission is terminated

and a later read mode request will begin transfer of the requested register data from the beginning. See Figure 3.

It is possible to interrupt a transmission to a MAX5395 with a new START (Repeated START) condition (perhaps addressing another device), which leaves the input registers with data that has not been transferred to the internal registers. The unused data will not be stored under these conditions. The aborted MAX5395 I<sup>2</sup>C sequence will have no effect on the part.

### I<sup>2</sup>C Acknowledge

In write mode, the acknowledge bit (ACK) is a clocked 9th bit that the MAX5395 uses to handshake receipt of each byte of data as shown in Figure 4. The MAX5395 pulls down SDA during the entire master-generated 9th clock pulse if the previous byte is successfully received. Monitoring ACK allows for detection of unsuccessful data transfers. An unsuccessful data transfer occurs if a receiving device is busy or if a system fault has occurred. In the event of an unsuccessful data transfer, the bus master will retry communication.

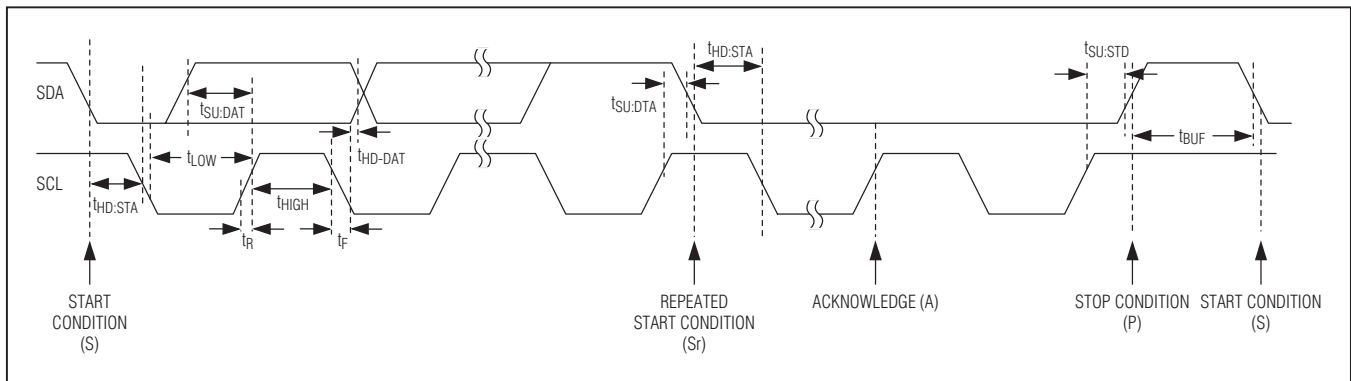

Figure 2. I<sup>2</sup>C Timing Diagram

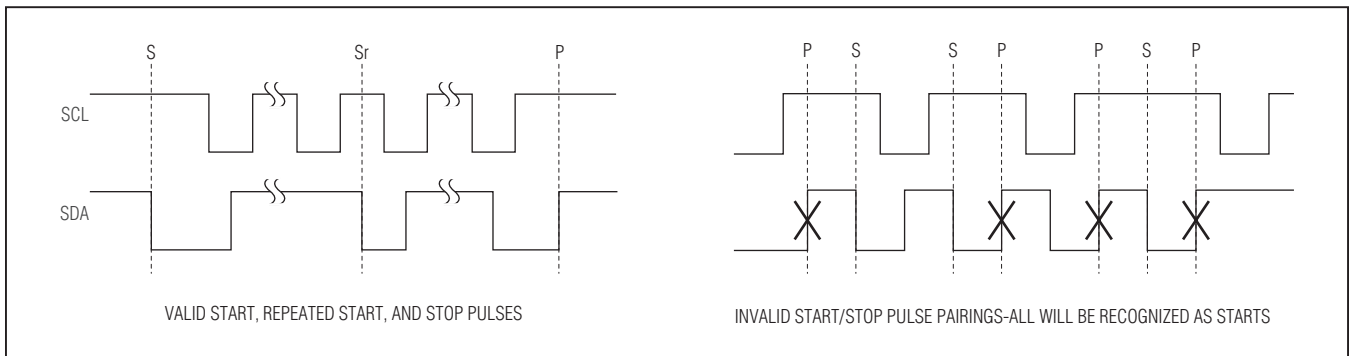

Figure 3. I<sup>2</sup>C START(s), Repeated START(S), and STOP(S) Conditions

# MAX5395

## Single, 256-Tap Volatile, I<sup>2</sup>C, Low-Voltage Linear Taper Digital Potentiometer

In read mode, the master pulls down SDA during the 9th clock cycle to acknowledge receipt of data from the MAX5395. An acknowledge is sent by the master after each read byte to allow data transfer to continue. A not-acknowledge is sent when the master reads the final byte of data from the MAX5395, followed by a STOP condition.

### I<sup>2</sup>C Slave Address

The slave address is defined as the seven most significant bits (MSBs) followed by the R/W bit. See [Figure 5](#) and [Figure 6](#). The five most significant bits are 01010 with the 3 LSBs determined ADDR0 as shown in [Table 1](#). Setting the R/W bit to 1 configures the MAX5395 for read mode. Setting the R/W bit to 0 configures the MAX5395 for write mode. The slave address is the first byte of information sent to the MAX5395 after the START condition.

The MAX5395 has the ability to detect an unconnected (N.C.) state on the ADDR0 input for additional address flexibility; if disconnecting the ADDR0 input, be certain to minimize all loading on the ADDR0 input (i.e. provide a landing for ADDR0, but do not allow any board traces).

### I<sup>2</sup>C Message Format for Writing

A master device communicates with the MAX5395 by transmitting the proper slave address followed by command and data word. Each transmit sequence is framed

**Table 1. I<sup>2</sup>C Slave Address LSBs**

ADDR0	A1	A0	SLAVE ADDRESS
GND	0	0	0101000
N.C.	0	1	0101001
V <sub>DD</sub>	1	1	0101011

N.C. = No connection.

by a START or Repeated START condition and a STOP condition as described above. Each word is 8 bits long and is always followed by an acknowledge clock (ACK) pulse as shown in [Figure 5](#). The first byte contains the address of the MAX5395 with R/W = 0 to indicate a write. The second byte contains the command to be executed and the third byte contains the data to be written.

### I<sup>2</sup>C Message Format for Readback Operations

Each readback sequence is framed by a START or Repeated START condition and a STOP condition. Each word is 8 bits long and is followed by an acknowledge clock pulse as shown in [Figure 6](#). The first byte contains the address of the MAX5395 with R/W = 0 to indicate a write. The second byte contains the register that is to be read back. There is a Repeated START condition, followed by the device address with R/W = 1 to indicate

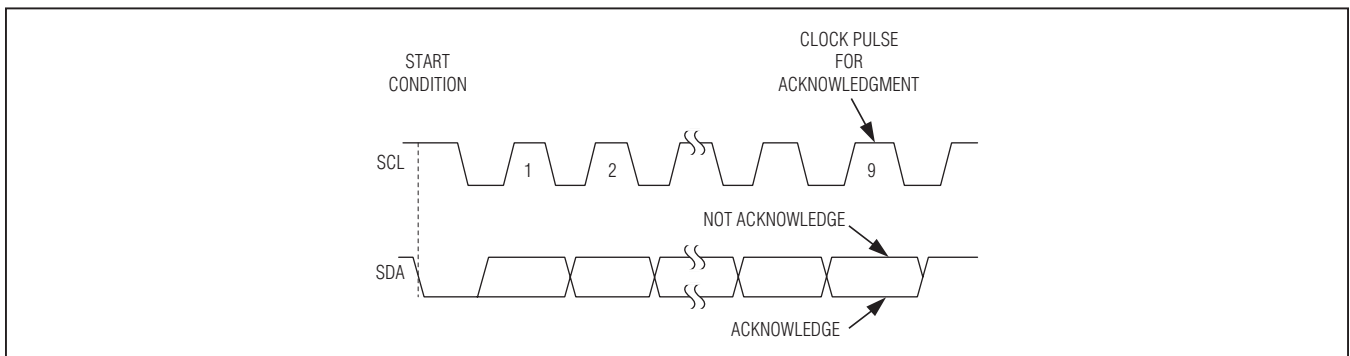

Figure 4. I<sup>2</sup>C Acknowledge

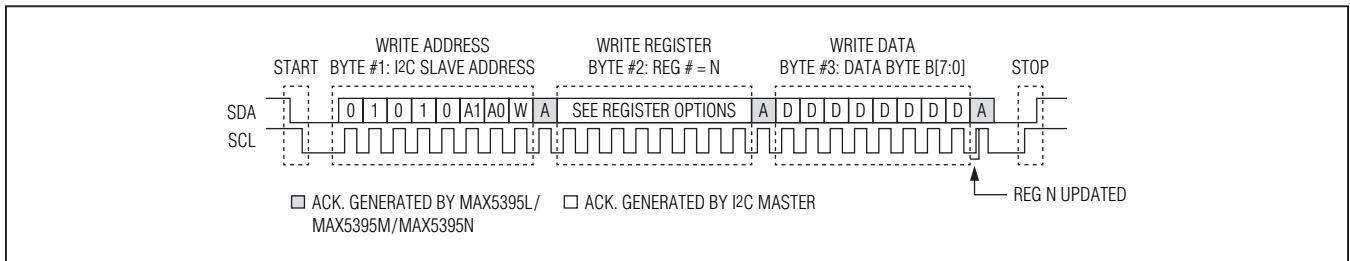

Figure 5. I<sup>2</sup>C Complete Write Serial Transmission

# MAX5395

## Single, 256-Tap Volatile, I<sup>2</sup>C, Low-Voltage Linear Taper Digital Potentiometer

a read and an acknowledge clock. The master has control of the SCL line but the MAX5395 takes over the SDA line. The final byte in the frame contains the register data readback followed by a STOP condition. If additional bytes beyond those required to read back the requested data are provided, the MAX5395 will continue to read back ones.

The wiper register and the configuration register are the only two registers that support readback (Table 2). Readback of all other registers is not supported and results in the readback of ones.

D[7:0]: Wiper position

QP: Charge pump status, 1 is enabled, 0 is disabled.

HSW: H terminal switch status, 0 is closed, 1 is open

WSW: W terminal switch status, 0 is closed, 1 is open

LSW: L terminal switch status, 0 is closed, 1 is open

TSEL[1:0]: Tap select, 00- wiper is at contents of wiper register, 01 – wiper is at 0x00, 10 – wiper is at 0x80, 11 – wiper is at 0xFF.

### General Call Support

The MAX5395 supports software reset through general call address 0x00 followed by R/W = 0, followed by 0x06 data. A software reset of the MAX5395 will return the part to the power-on default conditions. The MAX5395 will ACK the general call address and any command byte following, but will not support any general call features other than software reset.

**Table 2. I<sup>2</sup>C READ Command Byte Summary**

REGISTER	COMMAND BYTE								DATA BYTE							
	C7	C6	C5	C4	C3	C2	C1	C0	D7	D6	D5	D4	D3	D2	D1	D0
WIPER	0	0	0	0	0	0	0	0	D7	D6	D5	D4	D3	D2	D1	D0
CONFIG	1	0	0	0	0	0	0	0	QP	0	0	HSW	LSW	WSW	TSEL[1:0]	

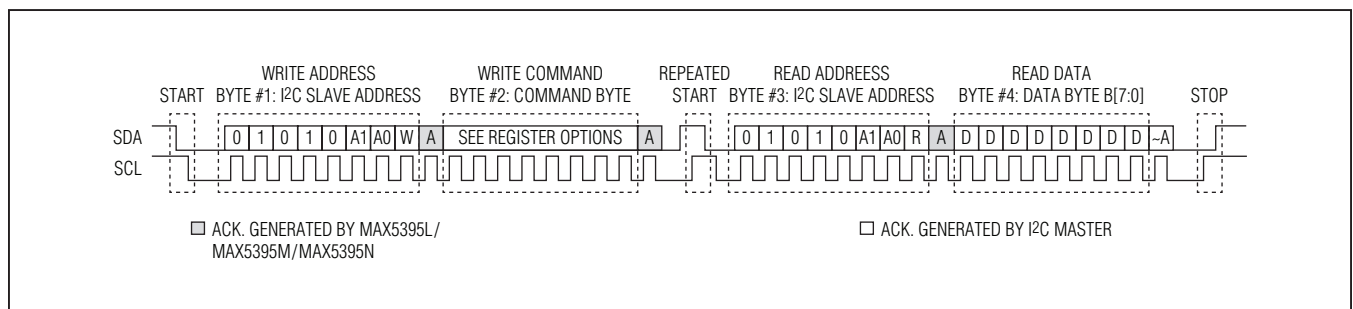

Figure 6. Standard I<sup>2</sup>C Register Read Sequence

## Single, 256-Tap Volatile, I<sup>2</sup>C, Low-Voltage Linear Taper Digital Potentiometer

**Table 3. I<sup>2</sup>C Write Command Byte Summary**

COMMAND	ADDRESS BYTE								COMMAND BYTE								DATA BYTE														
	A6	A5	A4	A3	A2	A1	A0	R/W	C7	C6	C5	C4	C3	C2	C1	C0	D7	D6	D5	D4	D3	D2	D1	D0							
WIPER	S See Table 1								0	0	0	0	0	0	0	0	D7	D6	D5	D4	D3	D2	D1	D0	A	P					
SD_CLR									0	1	0	0	0	0	0	0	0	0	0	0	0	Don't Care									
SD_H_WREG									0	1	0	0	1	0	0	0	0	0	0	0	Don't Care										
SD_H_ZERO									0	1	0	0	1	0	0	0	0	0	1	0	Don't Care										
SD_H_MID									0	1	0	0	1	0	0	1	0	0	1	0	Don't Care										
SD_H_FULL									0	1	0	0	1	0	0	1	0	0	1	1	Don't Care										
SD_L_WREG									0	A	1	0	0	0	1	0	0	0	0	0	Don't Care										
SD_L_ZERO									0	1	0	0	0	0	1	0	0	0	1	0	Don't Care										
SD_L_MID									0	1	0	0	0	1	0	1	0	1	0	0	Don't Care										
SD_L_FULL									0	1	0	0	0	1	0	1	1	1	0	0	Don't Care										
SD_W									0	1	0	0	0	0	1	X	X	0	0	0	Don't Care										
QP_OFF									0	1	0	1	0	0	0	0	0	0	0	0	Don't Care										
QP_ON									0	1	0	1	0	0	0	0	0	1	0	0	Don't Care										
RST									0	1	1	0	0	0	0	0	0	0	0	0	Don't Care										

### WIPER Command

The data byte writes to the wiper register and the potentiometer moves to the appropriate position. D[7:0] indicates the position of the wiper. D[7:0] = 0x00 moves the wiper to the position closest to L. D[7:0] = 0xFF moves the wiper closest to H. D[7:0] = 0x80 following power-on.

### SD\_CLR Command

Removes any existing shutdown condition. Connects all potentiometer terminals and returns the wiper to the value stored in the wiper register. The command does not affect the current status of the charge pump.

### SD\_H\_WREG Command

Opens the H terminal and maintains the wiper at the wiper register location. Writes cannot be made to the wiper register while shutdown mode is engaged. Clearing shutdown mode will close the H terminal and allow the wiper register to be written. A RST will also deassert shutdown mode and return the wiper to midscale (0x80). This command does not affect the charge-pump status.

### SD\_H\_ZERO Command

Moves wiper to zero-scale position (0x00) and opens the H terminal. The wiper register remains unaltered. Writes

cannot be made to the wiper register while shutdown mode is engaged. Clearing shutdown mode will return the wiper to the position contained in the wiper register and close the H terminal. A RST will also deassert shutdown mode and return the wiper to midscale (0x80). This command does not affect the charge-pump status.

### SD\_H\_MID Command

Moves wiper to midscale position (0x80) and opens the H terminal. The wiper register remains unaltered. Writes cannot be made to the wiper register while shutdown mode is engaged. Clearing shutdown mode will return the wiper to the position contained in the wiper register and close the H terminal. A RST will also deassert shutdown mode and return the wiper to midscale (0x80). This command does not affect the charge-pump status.

### SD\_H\_FULL Command

Moves wiper to full-scale position (0xFF) and opens the H terminal. The wiper register remains unaltered. Writes cannot be made to the wiper register while shutdown mode is engaged. Clearing shutdown mode will return the wiper to the position contained in the wiper register and close the H terminal. A RST will also deassert shutdown mode and return the wiper to midscale (0x80). This command does not affect the charge-pump status.

## Single, 256-Tap Volatile, I<sup>2</sup>C, Low-Voltage Linear Taper Digital Potentiometer

### ***SD\_L\_WREG Command***

Opens the L terminal and maintains the wiper at the wiper register location. Writes cannot be made to the wiper register while shutdown mode is engaged. Clearing shutdown mode will close the L terminal and allow wiper register to be written. A RST will also deassert shutdown mode and return the wiper to midscale (0x80). This command does not affect the charge-pump status.

### ***SD\_L\_ZERO Command***

Moves wiper to zero-scale position (0x00) and opens the L terminal. The wiper register remains unaltered. Writes cannot be made to the wiper register while shutdown mode is engaged. Clearing shutdown mode will return the wiper to the position contained in the wiper register and close the L terminal. A RST will also deassert shutdown mode and return the wiper to midscale (0x80). This command does not affect the charge-pump status.

### ***SD\_L\_MID Command***

Moves wiper to midscale position (0x80) and opens the L terminal. The wiper register remains unaltered. Writes cannot be made to the wiper register while shutdown mode is engaged. Clearing shutdown mode will return the wiper to the position contained in the wiper register and close the L terminal. A RST will also deassert shutdown mode and return the wiper to midscale (0x80). This command does not affect the charge-pump status.

### ***SD\_L\_FULL Command***

Moves wiper to full-scale position (0xFF) and opens the L terminal. The wiper register remains unaltered. Writes

cannot be made to the wiper register while shutdown mode is engaged. Clearing shutdown mode will return the wiper to the position contained in the wiper register and close the L terminal. A RST will also deassert shutdown mode and return the wiper to midscale (0x80). This command does not affect the charge-pump status.

### ***SD\_W Command***

Opens the W terminal keeping the internal tap position the same as the wiper register. Writes cannot be made to the wiper registers while shutdown mode is engaged. Clearing shutdown mode will return the wiper to the position contained in the wiper register and close W terminal. A RST will also deassert shutdown mode and return the wiper to midscale (0x80). This command does not affect the charge-pump status.

### ***QP\_OFF Command***

Disables the onboard charge pump and places device in low power mode. Low supply voltage is limited to 2.6V.

### ***QP\_ON Command***

Enables the onboard charge pump to allow low-supply voltage operation. This is the power-on default condition. Low supply voltage is 1.7V.

### ***RST Command***

Returns the device to power-on default conditions. Resets the wiper register to midscale (0x80), enables charge pump, and deasserts any shutdown modes.

# MAX5395

## Single, 256-Tap Volatile, I<sup>2</sup>C, Low-Voltage Linear Taper Digital Potentiometer

### Ordering Information

PART	PIN-PACKAGE	INTERFACE	TAPS	END-TO-END RESISTANCE (k $\Omega$ )
MAX5395LATA+T	8 TDFN-EP*	I <sup>2</sup> C	256	10
MAX5395MATA+T	8 TDFN-EP*	I <sup>2</sup> C	256	50
MAX5395NATA+T	8 TDFN-EP*	I <sup>2</sup> C	256	100

**Note:** All devices operate over the -40°C to +125°C temperature range.

+Denotes a lead(Pb)-free/RoHS-compliant package.

T = Tape and reel.

\*EP = Exposed pad.

### Chip Information

PROCESS: BiCMOS

### Package Information

For the latest package outline information and land patterns (footprints), go to [www.maximintegrated.com/packages](http://www.maximintegrated.com/packages). Note that a "+", "#", or "-" in the package code indicates RoHS status only. Package drawings may show a different suffix character, but the drawing pertains to the package regardless of RoHS status.

PACKAGE TYPE	PACKAGE CODE	OUTLINE NO.	LAND PATTERN NO.
8 TDFN-EP	T822+2	<a href="#">21-0168</a>	<a href="#">90-0065</a>



# MAX5395

## Single, 256-Tap Volatile, I<sup>2</sup>C, Low-Voltage Linear Taper Digital Potentiometer

### Revision History

REVISION NUMBER	REVISION DATE	DESCRIPTION	PAGES CHANGED
0	7/12	Initial release	—
1	9/12	Revised the <i>Absolute Maximum Ratings</i>	2



Maxim Integrated cannot assume responsibility for use of any circuitry other than circuitry entirely embodied in a Maxim Integrated product. No circuit patent licenses are implied. Maxim Integrated reserves the right to change the circuitry and specifications without notice at any time. The parametric values (min and max limits) shown in the Electrical Characteristics table are guaranteed. Other parametric values quoted in this data sheet are provided for guidance.

**Maxim Integrated 160 Rio Robles, San Jose, CA 95134 USA 1-408-601-1000**

17

© 2012 Maxim Integrated Products, Inc. The Maxim logo and Maxim Integrated are trademarks of Maxim Integrated Products, Inc.



Компания «ЭлектроПласт» предлагает заключение долгосрочных отношений при поставках импортных электронных компонентов на взаимовыгодных условиях!

Наши преимущества:

- Оперативные поставки широкого спектра электронных компонентов отечественного и импортного производства напрямую от производителей и с крупнейших мировых складов;
- Поставка более 17-ти миллионов наименований электронных компонентов;
- Поставка сложных, дефицитных, либо снятых с производства позиций;
- Оперативные сроки поставки под заказ (от 5 рабочих дней);
- Экспресс доставка в любую точку России;
- Техническая поддержка проекта, помощь в подборе аналогов, поставка прототипов;
- Система менеджмента качества сертифицирована по Международному стандарту ISO 9001;
- Лицензия ФСБ на осуществление работ с использованием сведений, составляющих государственную тайну;
- Поставка специализированных компонентов (Xilinx, Altera, Analog Devices, Intersil, Interpoint, Microsemi, Aeroflex, Peregrine, Syfer, Eurofarad, Texas Instrument, Miteq, Cobham, E2V, MA-COM, Hittite, Mini-Circuits, General Dynamics и др.);

Помимо этого, одним из направлений компании «ЭлектроПласт» является направление «Источники питания». Мы предлагаем Вам помощь Конструкторского отдела:

- Подбор оптимального решения, техническое обоснование при выборе компонента;
- Подбор аналогов;
- Консультации по применению компонента;
- Поставка образцов и прототипов;
- Техническая поддержка проекта;
- Защита от снятия компонента с производства.



#### Как с нами связаться

**Телефон:** 8 (812) 309 58 32 (многоканальный)

**Факс:** 8 (812) 320-02-42

**Электронная почта:** [org@eplast1.ru](mailto:org@eplast1.ru)

**Адрес:** 198099, г. Санкт-Петербург, ул. Калинина, дом 2, корпус 4, литера А.