

## IR Receiver Modules for Remote Control Systems



20953

### DESIGN SUPPORT TOOLS

[click logo to get started](#)


### MECHANICAL DATA

#### Pinning:

 1, 4 = GND, 2 =  $V_S$ , 3 = OUT

### ORDERING CODE

#### Taping:

TSOP77...TT - top view taped

TSOP77...TR - side view taped

### FEATURES

- Improved immunity against HF and RF noise
- Continuous data transmission possible
- Low supply current
- Photo detector and preamplifier in one package
- Internal filter for PCM frequency
- Supply voltage: 2.5 V to 5.5 V
- Improved immunity against ambient light
- Capable of side or top view
- Insensitive to supply voltage ripple and noise
- Two lenses for high sensitivity and wide receiving angle
- Material categorization: for definitions of compliance please see [www.vishay.com/doc?99912](http://www.vishay.com/doc?99912)



### DESCRIPTION

The TSOP773.., TSOP775.. series are a two lens miniaturized receiver module for infrared remote control systems. One PIN diode per lens and a preamplifier are assembled on a leadframe, the epoxy lens cap contains an IR filter.

The TSOP773.. series devices are optimized to suppress almost all spurious pulses from Wi-Fi and CFL sources. They may suppress some data signals if continuously transmitted.

New designs should prefer the TSOP773.. series containing the newer AGC3. The TSOP775.. series are useful to suppress even extreme levels of optical noise, but may also suppress some data signals. Please check compatibility with your codes.

These components have not been qualified according to automotive specifications.

| PARTS TABLE       |        |  |   |
|-------------------|--------|--|---|
| AGC               |        | NOISY ENVIRONMENTS AND SHORT BURSTS (AGC3)   | VERY NOISY ENVIRONMENTS AND SHORT BURSTS (AGC5) |
| Carrier frequency | 30 kHz | TSOP77330  | TSOP77530                                       |
|                   | 33 kHz | TSOP77333  | TSOP77533                                       |
|                   | 36 kHz | TSOP77336 <sup>(1)</sup>   | TSOP77536                                       |
|                   | 38 kHz | TSOP77338 <sup>(2)(3)(4)(5)</sup>  | TSOP77538                                       |
|                   | 40 kHz | TSOP77340  | TSOP77540                                       |
|                   | 56 kHz | TSOP77356  | TSOP77556                                       |
| Package           |        | Heimdall   |   |
| Pinning           |        | 1, 4 = GND, 2 = $V_S$ , 3 = OUT  |   |
| Dimensions (mm)   |        | 6.8 W x 3.0 H x 3.2 D  |   |
| Mounting          |        | SMD  |   |
| Application       |        | Remote control   |   |
| Best choice for   |        | <sup>(1)</sup> MCIR <sup>(2)</sup> Mitsubishi <sup>(3)</sup> RECS-80 Code <sup>(4)</sup> r-map <sup>(5)</sup> XMP-1, XMP-2 |   |

**BLOCK DIAGRAM**

**APPLICATION CIRCUIT**


$R_1$  and  $C_1$  recommended to reduce supply ripple for  $V_S < 2.8$  V

**ABSOLUTE MAXIMUM RATINGS**

| PARAMETER                   | TEST CONDITION                | SYMBOL      | VALUE                   | UNIT |
|-----------------------------|-------------------------------|-------------|-------------------------|------|
| Supply voltage              |                               | $V_S$       | -0.3 to +6              | V    |
| Supply current              |                               | $I_S$       | 5                       | mA   |
| Output voltage              |                               | $V_O$       | -0.3 to 5.5             | V    |
| Voltage at output to supply |                               | $V_S - V_O$ | -0.3 to ( $V_S + 0.3$ ) | V    |
| Output current              |                               | $I_O$       | 5                       | mA   |
| Junction temperature        |                               | $T_j$       | 100                     | °C   |
| Storage temperature range   |                               | $T_{stg}$   | -25 to +85              | °C   |
| Operating temperature range |                               | $T_{amb}$   | -25 to +85              | °C   |
| Power consumption           | $T_{amb} \leq 85$ °C          | $P_{tot}$   | 10                      | mW   |
| Soldering temperature       | $t \leq 10$ s, 1 mm from case | $T_{sd}$    | 260                     | °C   |

**Note**

- Stresses beyond those listed under "Absolute Maximum Ratings" may cause permanent damage to the device. This is a stress rating only and functional operation of the device at these or any other conditions beyond those indicated in the operational sections of this specification is not implied. Exposure to absolute maximum rating conditions for extended periods may affect the device reliability

**ELECTRICAL AND OPTICAL CHARACTERISTICS ( $T_{amb} = 25$  °C, unless otherwise specified)**

| PARAMETER             | TEST CONDITION  | SYMBOL             | MIN. | TYP.     | MAX. | UNIT              |
|-----------------------|---|--------------------|------|----------|------|-------------------|
| Supply voltage        |   | $V_S$              | 2.5  | -        | 5.5  | V                 |
| Supply current        | $V_S = 5$ V, $E_v = 0$  | $I_{SD}$           | 0.55 | 0.7      | 0.9  | mA                |
|                       | $E_v = 40$ klx, sunlight  | $I_{SH}$           | -    | 0.8      | -    | mA                |
| Transmission distance | $E_v = 0$ , IR diode TSAL6200, $I_F = 250$ mA, test signal see Fig. 1                         | $d$                | -    | 40       | -    | m                 |
| Output voltage low    | $I_{OSL} = 0.5$ mA, $E_e = 0.7$ mW/m <sup>2</sup> , test signal see Fig. 1                    | $V_{OSL}$          | -    | -        | 100  | mV                |
| Minimum irradiance    | Pulse width tolerance:<br>$t_{pi} - 5/f_0 < t_{po} < t_{pi} + 6/f_0$ , test signal see Fig. 1 | $E_e \text{ min.}$ | -    | 0.2      | 0.4  | mW/m <sup>2</sup> |
| Maximum irradiance    | $t_{pi} - 5/f_0 < t_{po} < t_{pi} + 6/f_0$ , test signal see Fig. 1                           | $E_e \text{ max.}$ | 50   | -        | -    | W/m <sup>2</sup>  |
| Directivity           | Angle of half transmission distance   | $\phi_{1/2}$       | -    | $\pm 50$ | -    | deg               |

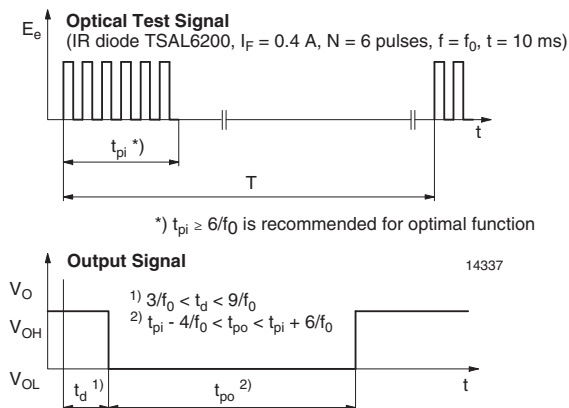
**TYPICAL CHARACTERISTICS ( $T_{amb} = 25$  °C, unless otherwise specified)**


Fig. 1 - Output Active Low

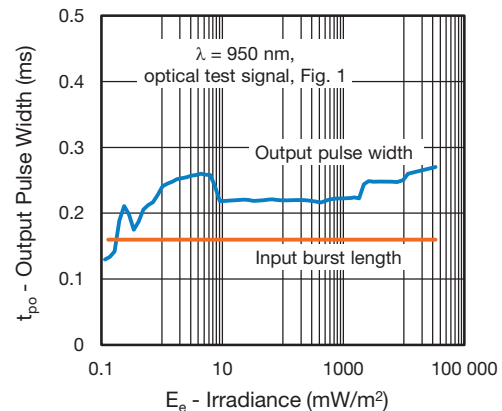


Fig. 2 - Pulse Length and Sensitivity in Dark Ambient



Fig. 3 - Output Function

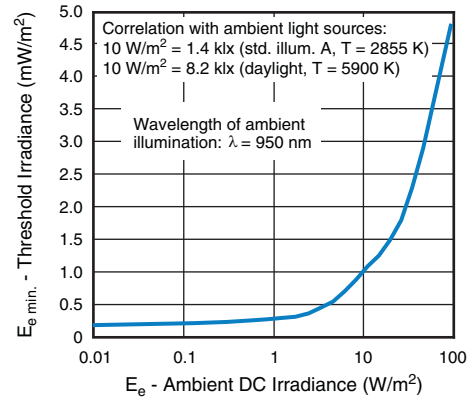


Fig. 6 - Sensitivity in Bright Ambient

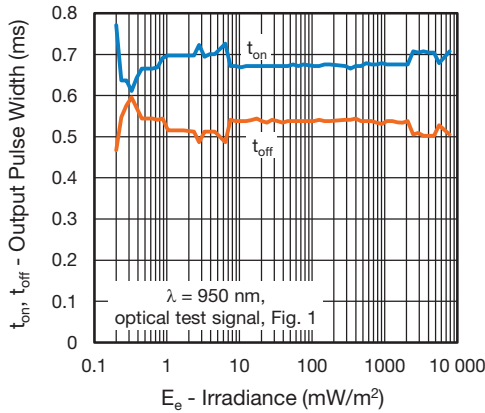


Fig. 4 - Output Pulse Diagram



Fig. 7 - Sensitivity vs. Supply Voltage Disturbances

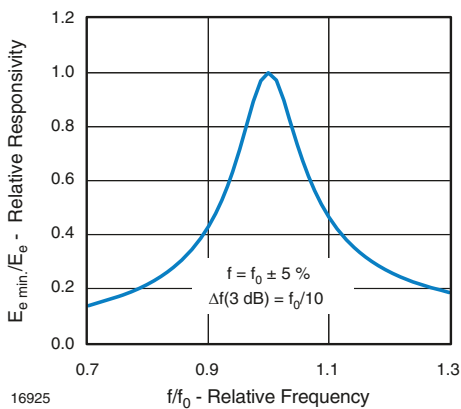


Fig. 5 - Frequency Dependence of Responsivity

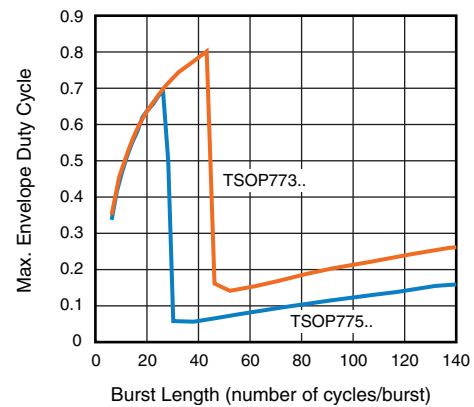


Fig. 8 - Max. Envelope Duty Cycle vs. Burst Length

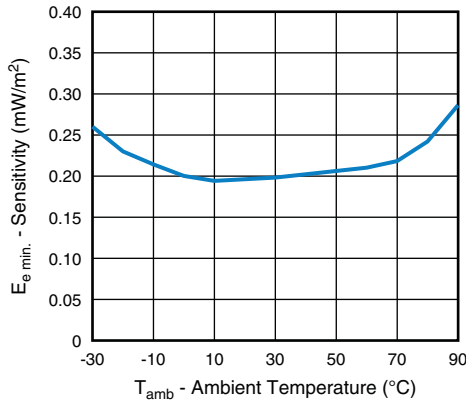


Fig. 9 - Sensitivity vs. Ambient Temperature



Fig. 12 - Vertical Directivity

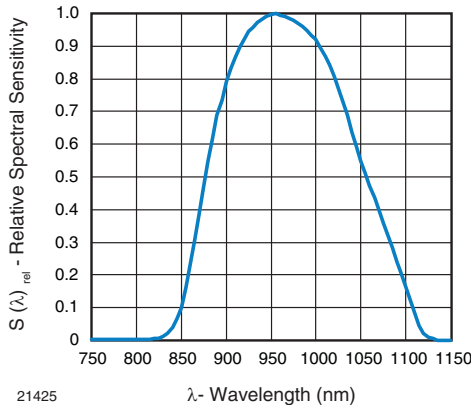


Fig. 10 - Relative Spectral Sensitivity vs. Wavelength



Fig. 1 Sensitivity vs. Supply Voltage

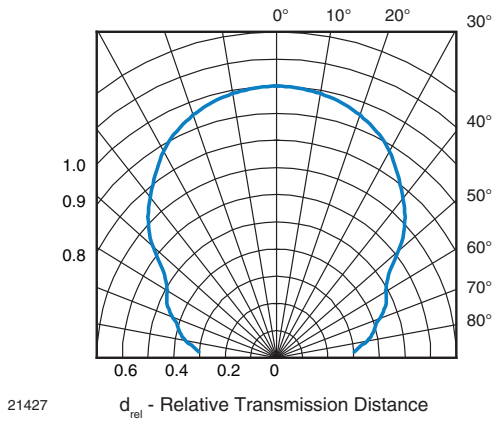


Fig. 11 - Horizontal Directivity

**SUITABLE DATA FORMAT**

These products are designed to suppress spurious output pulses due to noise or disturbance signals. Data and disturbance signals can be distinguished by the devices according to carrier frequency, burst length and envelope duty cycle. The data signal should be close to the band-pass center frequency (e.g. 38 kHz) and fulfill the conditions in the table below.

When a data signal is applied to the IR receiver in the presence of a disturbance signal, the sensitivity of the receiver is reduced to insure that no spurious pulses are present at the output. Some examples of disturbance signals which are suppressed are:

- DC light (e.g. from tungsten bulb or sunlight)
- Continuous signals at any frequency
- Modulated IR pattern from common fluorescent lamps (example of noise pattern is shown in Fig. 13 or Fig. 14)
- 2.4 GHz and 5 GHz Wi-Fi



Fig. 13 - IR Disturbance from Fluorescent Lamp With Low Modulation



Fig. 14 - IR Disturbance from Fluorescent Lamp With High Modulation

|  | <b>TSOP773..</b>  | <b>TSOP775..</b>  |
|--|---|---|
| Minimum burst length   | 6 cycles/burst  | 6 cycles/burst  |
| After each burst of length a minimum gap time is required of               | 6 to 35 cycles<br>≥ 10 cycles   | 6 to 24 cycles<br>≥ 10 cycles   |
| For bursts greater than a minimum gap time in the data stream is needed of | 35 cycles<br>> 4 x burst length   | 24 cycles<br>> 25 ms  |
| Maximum number of continuous short bursts/second                           | 2000  | 2000  |
| MCIR code  | Preferred   | Yes   |
| XMP-1, XMP-2 code  | Preferred   | Yes   |
| Suppression of interference from fluorescent lamps                         | Mild and complex disturbance patterns are suppressed (example: signal pattern of Fig. 13 and Fig. 14) | Critical disturbance patterns are suppressed, e.g. highly dimmed LCDs |

**Note**

- For data formats with long bursts please see the datasheet for TSOP772.., TSOP774..

**PACKAGE DIMENSIONS** in millimeters



**ASSEMBLY INSTRUCTIONS**

**Reflow Soldering**

- Reflow soldering must be done within 72 h while stored under a max. temperature of 30 °C, 60 % RH after opening the dry pack envelope
- Set the furnace temperatures for pre-heating and heating in accordance with the reflow temperature profile as shown in the diagram. Exercise extreme care to keep the maximum temperature below 260 °C. The temperature shown in the profile means the temperature at the device surface. Since there is a temperature difference between the component and the circuit board, it should be verified that the temperature of the device is accurately being measured
- Handling after reflow should be done only after the work surface has been cooled off

**Manual Soldering**

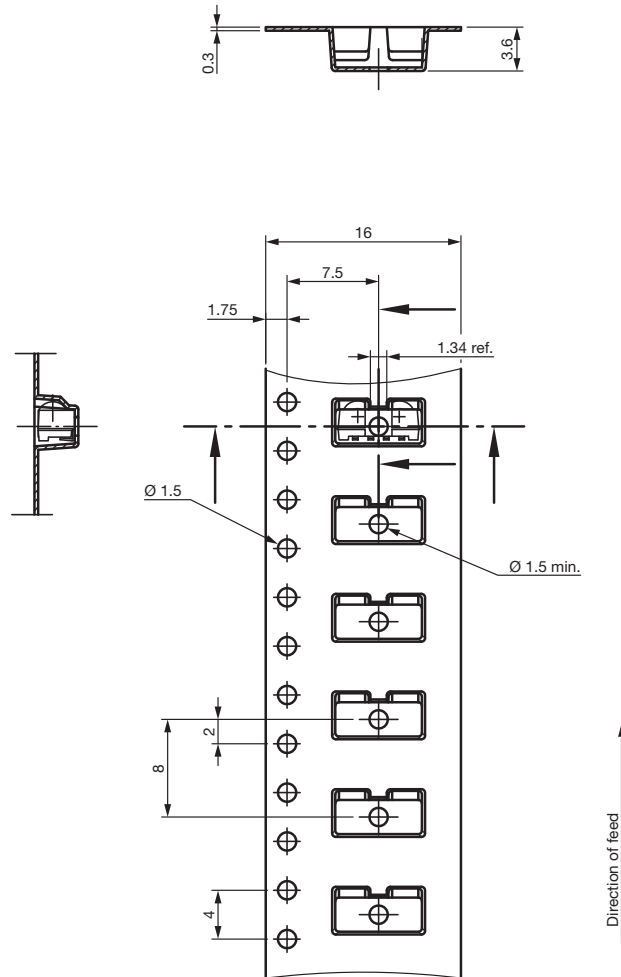
- Use a soldering iron of 25 W or less. Adjust the temperature of the soldering iron below 300 °C
- Finish soldering within 3 s
- Handle products only after the temperature has cooled off



## VISHAY LEAD (Pb)-FREE REFLOW SOLDER PROFILE



## TAPING VERSION TSOP..TR DIMENSIONS in millimeters



Drawing-No.: 9.700-5337.01-4  
Issue: 2; 06.10.15





## TAPING VERSION TSOP..TT DIMENSIONS in millimeters



Drawing-No.: 9.700-5338.01-4  
Issue: 4; 12.06.13



technical drawings  
according to DIN  
specifications



**REEL DIMENSIONS** in millimeters



Form of the leave open of the wheel is supplier specific.

Dimension acc. to IEC EN 60 286-3

Tape width 16



technical drawings according to DIN specifications

Drawing-No.: 9.800-5052.V2-4

Issue: 1; 07.05.02

16734

**LEADER AND TRAILER DIMENSIONS** in millimeters



**COVER TAPE PEEL STRENGTH**

According to DIN EN 60286-3

0.1 N to 1.3 N

300 ± 10 mm/min.

165° to 180° peel angle

**LABEL**

**Standard bar code labels for finished goods**

The standard bar code labels are product labels and used for identification of goods. The finished goods are packed in final packing area. The standard packing units are labeled with standard bar code labels before transported as finished goods to warehouses. The labels are on each packing unit and contain Vishay Semiconductor GmbH specific data.

| <b>VISHAY SEMICONDUCTOR GmbH STANDARD BAR CODE PRODUCT LABEL (finished goods)</b> |                     |               |
|---|---------------------|---------------|
| <b>PLAIN WRITING</b>  | <b>ABBREVIATION</b> | <b>LENGTH</b> |
| Item-description  | -                   | 18            |
| Item-number   | INO                 | 8             |
| Selection-code  | SEL                 | 3             |
| LOT-/serial-number  | BATCH               | 10            |
| Data-code   | COD                 | 3 (YWW)       |
| Plant-code  | PTC                 | 2             |
| Quantity  | QTY                 | 8             |
| Accepted by   | ACC                 | -             |
| Packed by   | PCK                 | -             |
| Mixed code indicator  | MIXED CODE          | -             |
| Origin  | xxxxxxx+            | Company logo  |
| <b>LONG BAR CODE TOP</b>  | <b>TYPE</b>         | <b>LENGTH</b> |
| Item-number   | N                   | 8             |
| Plant-code  | N                   | 2             |
| Sequence-number   | X                   | 3             |
| Quantity  | N                   | 8             |
| Total length  | -                   | 21            |
| <b>SHORT BAR CODE BOTTOM</b>  | <b>TYPE</b>         | <b>LENGTH</b> |
| Selection-code  | X                   | 3             |
| Data-code   | N                   | 3             |
| Batch-number  | X                   | 10            |
| Filter  | -                   | 1             |
| Total length  | -                   | 17            |

### DRY PACKING

The reel is packed in an anti-humidity bag to protect the devices from absorbing moisture during transportation and storage.



### FINAL PACKING

The sealed reel is packed into a cardboard box.

### RECOMMENDED METHOD OF STORAGE

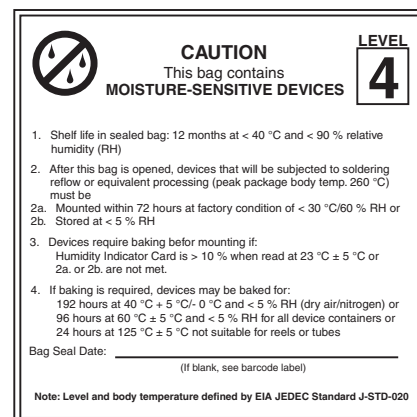
Dry box storage is recommended as soon as the aluminum bag has been opened to prevent moisture absorption. The following conditions should be observed, if dry boxes are not available:

- Storage temperature 10 °C to 30 °C
- Storage humidity ≤ 60 % RH max.

After more than 72 h under these conditions moisture content will be too high for reflow soldering.

In case of moisture absorption, the devices will recover to the former condition by drying under the following condition:  
 192 h at 40 °C + 5 °C / - 0 °C and < 5 % RH (dry air / nitrogen) or  
 96 h at 60 °C + 5 °C and < 5 % RH for all device containers or  
 24 h at 125 °C + 5 °C not suitable for reel or tubes.

An EIA JEDEC® standard J-STD-020 level 4 label is included on all dry bags.



EIA JEDEC standard J-STD-020 level 4 is included on all dry bags



### ESD PRECAUTION

Proper storage and handling procedures should be followed to prevent ESD damage to the devices especially when they are removed from the antistatic shielding bag. Electrostatic sensitive devices warning labels are on the packaging.

### VISHAY SEMICONDUCTORS STANDARD BAR CODE LABELS

The Vishay Semiconductors standard bar code labels are printed at final packing areas. The labels are on each packing unit and contain Vishay Semiconductors specific data.



22178



## Tape and Reel Standards for Surface-Mount IR Receiver Modules

Vishay Semiconductor surface-mount IR receivers are packaged on tape and reel. The following specification is based on IEC publication 286, which takes the industrial requirements for automatic insertion into account.

Absolute maximum ratings, mechanical dimensions, optical and electrical characteristics for taped devices are identical to the basic catalog types and can be found in the specifications for untaped devices.

### PACKAGING

The tapes of components are available on reels. Each reel is marked with labels which contain the following information:

- Vishay
- Type
- Group
- Tape code, normally part of type name
- Production code
- Quantity

### MISSING COMPONENTS

Up to 3 consecutive components may be missing if the gap is followed by at least 6 components. A maximum of 0.5 % of the components per reel quantity may be missing. At least 5 empty positions are present at the start and the end of the tape to enable tape insertion.

**Tensile strength** of the tape: > 15 N

### NUMBER OF COMPONENTS

- A. Panhead: quantity per reel:
  - TT, top view package, 1190 pcs
  - TR, side view package, 1120 pcs
- B. Heimdall: quantity per reel:
  - TT, top view package, 2200 pcs
  - TR, side view package, 2300 pcs
- C. Heimdall without lens: quantity per reel:
  - WTT, top view package, 2200 pcs
  - WTR, side view package, 2300 pcs
- D. Belobog: quantity per reel:
  - TT1, top view package, 1800 pcs
- E. Belobog with shield: quantity per reel:
  - TT1, top view package, 1500 pcs
- F. Minimold DF1P: quantity per reel:
  - DF1P, 1100 pcs
- G. TVCastSMD TR1: quantity per reel:
  - TR1, side view package, 2000 pcs

### ORDER DESIGNATION

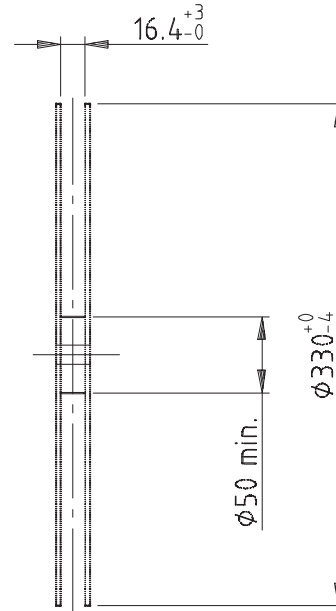
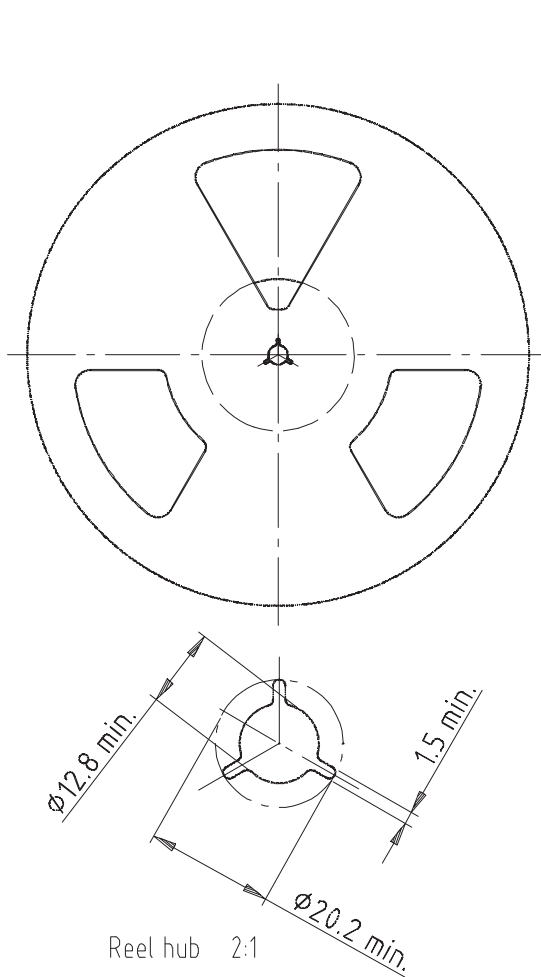
The type designation of the device is extended by TT or TT1 for top view or TR for side view.

#### Example:

- TSOP6238TR (reel packing)
- TSOP75238TR (reel packing)
- TSOP75338WTT (reel packing)
- TSOP57438TT1 (reel packing)
- TSOP57238HTT1 (reel packing)
- TSOP39438TR1 (reel packing)



## REEL DIMENSIONS FOR PANHEAD, HEIMDALL, AND TVCASTSMD TR in millimeters



Form of the leave open of the wheel is supplier specific.

Dimension acc. to IEC EN 60 286-3

Tape width 16



technical drawings according to DIN specifications

Drawing-No.: 9.800-5052.V2-4

Issue: 1; 07.05.02

16734

### Note

- The body structure of the reel can vary



## TAPING VERSION TSOP..TT (TOP VIEW) DIMENSIONS in millimeters

A. Panhead (TSOP36...TT, TSSP...TT, TSOP6...TT, TSOP16...TT, TSOP96...TT)



Drawing-No.: 9.700-5259.01-4

Issue: 1; 05.09.01

16584



## TAPING VERSION TSOP..TT (TOP VIEW) DIMENSIONS in millimeters

B. Heimdall (TSOP75...TT, TSOP77...TT, TSSP77...TT, TSOP15...TT, TSOP95...TT)



Drawing-No.: 9.700-5338.01-4  
Issue: 4; 12.06.13



technical drawings  
according to DIN  
specifications

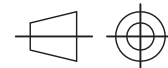


## TAPING VERSION TSOP..TT (TOP VIEW) DIMENSIONS in millimeters

C. Heimdall without lens (TSOP75...WTT, TSOP77...WTT, TSSP77...WTT, TSOP15...WTT, TSOP95...WTT)



Drawing-No.: 9.700-5341.01-4  
Issue: 3; 06.10.15



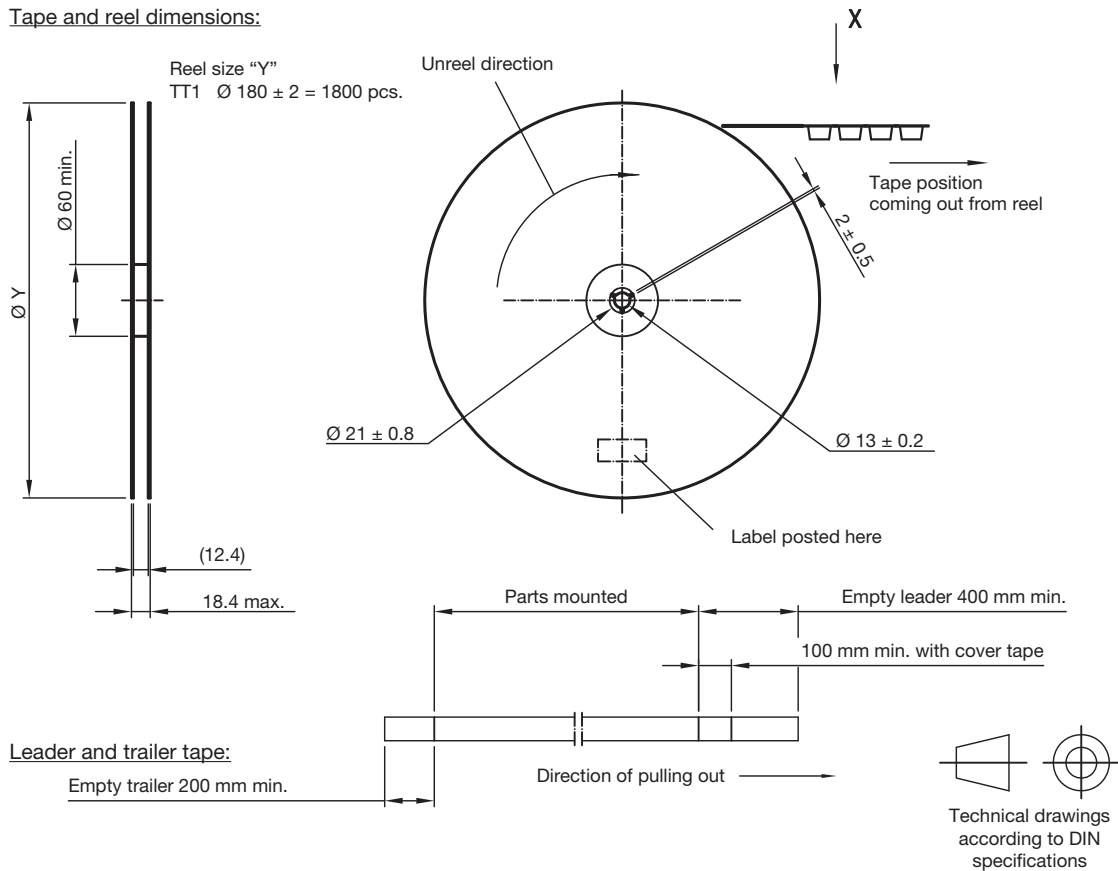
technical drawings  
according to DIN  
specifications



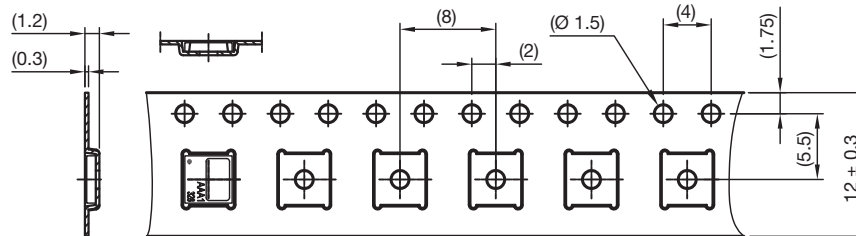
## TAPING VERSION TSOP..TT1 (TOP VIEW) DIMENSIONS in millimeters

D. Belobog (TSOP37...TT1, TSOP57...TT1, TSOP17...TT1, TSOP97...TT1)

Tape and reel dimensions:



X 2:1



Drawing-No.: 9.700-5347.01-4  
Issue: 2; 07.03.18

Not indicated tolerances  $\pm 0.1$

## TAPING VERSION TSOP..TT1 (TOP VIEW) DIMENSIONS in millimeters

E. Belobog with shield (TSOP37...HTT1, TSOP57...HTT1, TSOP17...HTT1, TSOP97...HTT1)

Tape and reel dimensions:



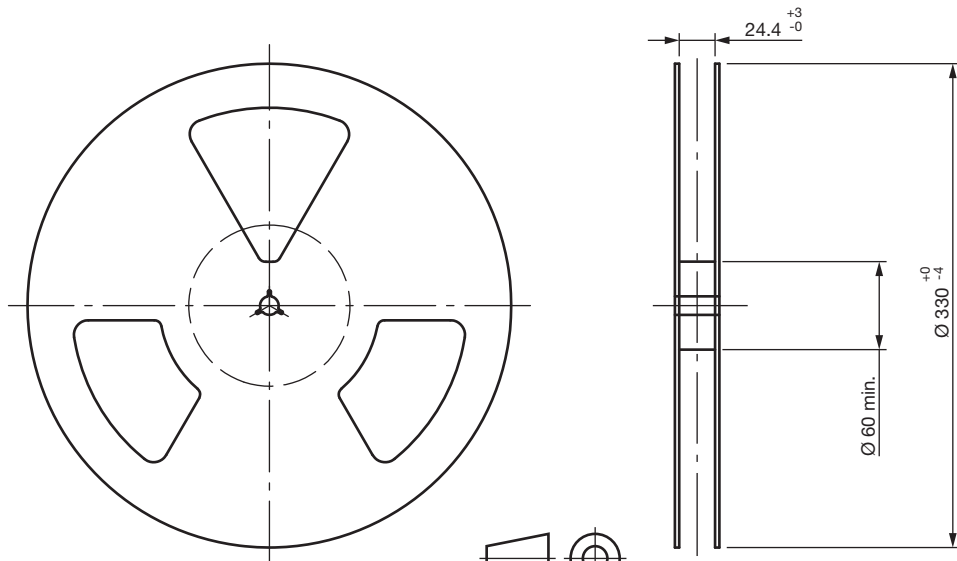
Drawing-No.: 9.700-5380.01-4  
Issue: 3; 07.03.18

Not indicated tolerances  $\pm 0.1$



### TAPING VERSION TSOP..DF1P (SIDE VIEW) DIMENSIONS in millimeters

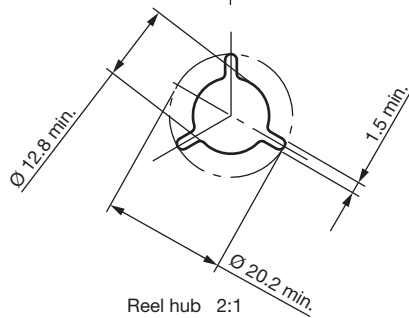
F. Minimold DF1P (TSOP33...DF1P, TSOP53...DF1P, TSOP13...DF1P, TSOP93...DF1P)



Technical drawing according to DIN specifications

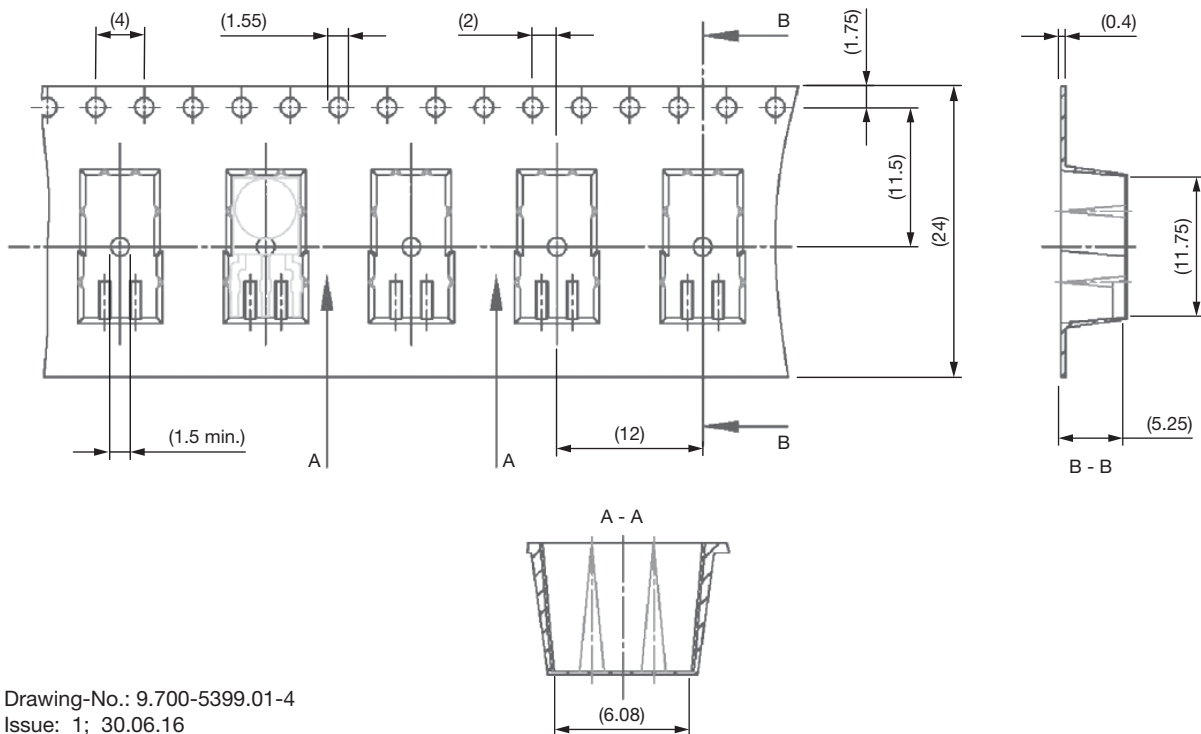
Form of the leave open of the wheel is supplier specific. Dimensions according to IEC EN 60 286-3

Tape width: 24



Reel hub 2:1

Drawing-No.: 9.800-5052.V3-4  
Issue: 1; 17.12.02



Drawing-No.: 9.700-5399.01-4  
Issue: 1; 30.06.16

## TAPING VERSION TSOP..TR (SIDE VIEW) DIMENSIONS in millimeters

G. TVCastSMD TR1 (TSOP59...TR1, TSOP39...TR1, TSOP19...TR1, TSOP99...TR1)



Drawing-No.: GO-100220.10\_Z  
Issue B: 08.02.17

## TAPING VERSION TSOP..TR (SIDE VIEW) DIMENSIONS in millimeters

A. Panhead (TSOP36...TR, TSSP6...TR, TSOP6...TR, TSOP16...TR, TSOP96...TR)



Drawing-No.: 9.700-5260.01-4

Issue: 2; 25.09..01

16585



## TAPING VERSION TSOP..TR (SIDE VIEW) DIMENSIONS in millimeters

B. Heimdall (TSSP7...., TSOP75...TR, TSOP77...TR, TSSP7....TR, TSOP15...TR, TSOP95...TR)



Drawing-No.: 9.700-5337.01-4  
Issue: 2; 06.10.15



technical drawings  
according to DIN  
specifications



## TAPING VERSION TSOP..TR (SIDE VIEW) DIMENSIONS in millimeters

C. Heimdall without lens (TSOP75...WTR, TSOP77...WTR, TSSP...WTR, TSOP15...WTR, TSOP95...WTR)



Drawing-No.: 9.700-5342.01-4  
Issue: 2; 12.06.13

technical drawings  
according to DIN  
specifications

### LEADER AND TRAILER DIMENSIONS in millimeters



### COVER TAPE REEL STRENGTH

According to DIN EN 60286-3

0.1 N to 1.3 N

300 mm/min.  $\pm$  10 mm/min.

165° to 180° peel angle

### LABEL

#### Standard bar code labels for finished goods

The standard bar code labels are product labels and used for identification of goods. The finished goods are packed in final packing area. The standard packing units are labeled with standard bar code labels before transported as finished goods to warehouses. The labels are on each packing unit and contain Vishay Semiconductor GmbH specific data.

| VISHAY SEMICONDUCTOR GmbH STANDARD BAR CODE PRODUCT LABEL (finished goods) |              |              |
|--|--------------|--------------|
| PLAIN WRITING  | ABBREVIATION | LENGTH       |
| Item-description   | -            | 18           |
| Item-number  | INO          | 8            |
| Selection-code   | SEL          | 3            |
| LOT-/serial-number   | BATCH        | 10           |
| Data-code  | COD          | 3 (YWW)      |
| Plant-code   | PTC          | 2            |
| Quantity   | QTY          | 8            |
| Accepted by  | ACC          | -            |
| Packed by  | PCK          | -            |
| Mixed code indicator   | MIXED CODE   | -            |
| Origin   | xxxxxxx+     | Company logo |
| LONG BAR CODE TOP  | TYPE         | LENGTH       |
| Item-number  | N            | 8            |
| Plant-code   | N            | 2            |
| Sequence-number  | X            | 3            |
| Quantity   | N            | 8            |
| Total length   | -            | 21           |
| SHORT BAR CODE TOP   | TYPE         | LENGTH       |
| Selection-code   | X            | 3            |
| Data-code  | N            | 3            |
| Batch-number   | X            | 10           |
| Filter   | -            | 1            |
| Total length   | -            | 17           |



## DRY PACKAGING

The reel is packed in an anti-humidity bag to protect the devices from absorbing moisture during transportation and storage.



15973

## RECOMMENDED METHOD OF STORAGE

Dry box storage is recommended as soon as the aluminum bag has been opened to prevent moisture absorption. The following conditions should be observed, if dry boxes are not available:

- Storage temperature 10 °C to 30 °C
- Storage humidity ≤ 60 % RH max.

After more than 72 h under these conditions moisture content will be too high for reflow soldering.

In case of moisture absorption, the devices will recover to the former condition by drying under the following condition:

- 192 h at 40 °C + 5 °C / - 0 °C and < 5 % RH (dry air / nitrogen) or
- 96 h at 60 °C + 5 °C and < 5 % RH for all device containers or
- 24 h at 125 °C + 5 °C not suitable for reel or tubes.

An EIA JEDEC® standard JSTD-020 level 4 label is included on all dry bags.



22522

EIA JEDEC standard JSTD-020 level 4 label is included on all dry bags

## ESD PRECAUTION

Proper storage and handling procedures should be followed to prevent ESD damage to the devices especially when they are removed from the antistatic shielding bag. Electrostatic sensitive devices warning labels are on the packaging.

## VISHAY SEMICONDUCTORS STANDARD BAR CODE LABELS

The Vishay Semiconductors standard bar code labels are printed at final packing areas. The labels are on each packing unit and contain Vishay Semiconductors specific data.



16962

## OUTER PACKAGING

The sealed reel is packed into a pizza box.

| CARTON BOX DIMENSIONS in millimeters           |           |       |        |
|--|-----------|-------|--------|
|  |           |       |        |
|  | THICKNESS | WIDTH | LENGTH |
| Pizza box (SMD and heimdall) (taping in reels) | 50        | 340   | 340    |

22127



## **Disclaimer**

ALL PRODUCT, PRODUCT SPECIFICATIONS AND DATA ARE SUBJECT TO CHANGE WITHOUT NOTICE TO IMPROVE RELIABILITY, FUNCTION OR DESIGN OR OTHERWISE.

Vishay Intertechnology, Inc., its affiliates, agents, and employees, and all persons acting on its or their behalf (collectively, "Vishay"), disclaim any and all liability for any errors, inaccuracies or incompleteness contained in any datasheet or in any other disclosure relating to any product.

Vishay makes no warranty, representation or guarantee regarding the suitability of the products for any particular purpose or the continuing production of any product. To the maximum extent permitted by applicable law, Vishay disclaims (i) any and all liability arising out of the application or use of any product, (ii) any and all liability, including without limitation special, consequential or incidental damages, and (iii) any and all implied warranties, including warranties of fitness for particular purpose, non-infringement and merchantability.

Statements regarding the suitability of products for certain types of applications are based on Vishay's knowledge of typical requirements that are often placed on Vishay products in generic applications. Such statements are not binding statements about the suitability of products for a particular application. It is the customer's responsibility to validate that a particular product with the properties described in the product specification is suitable for use in a particular application. Parameters provided in datasheets and / or specifications may vary in different applications and performance may vary over time. All operating parameters, including typical parameters, must be validated for each customer application by the customer's technical experts. Product specifications do not expand or otherwise modify Vishay's terms and conditions of purchase, including but not limited to the warranty expressed therein.

Except as expressly indicated in writing, Vishay products are not designed for use in medical, life-saving, or life-sustaining applications or for any other application in which the failure of the Vishay product could result in personal injury or death. Customers using or selling Vishay products not expressly indicated for use in such applications do so at their own risk. Please contact authorized Vishay personnel to obtain written terms and conditions regarding products designed for such applications.

No license, express or implied, by estoppel or otherwise, to any intellectual property rights is granted by this document or by any conduct of Vishay. Product names and markings noted herein may be trademarks of their respective owners.



Компания «ЭлектроПласт» предлагает заключение долгосрочных отношений при поставках импортных электронных компонентов на взаимовыгодных условиях!

Наши преимущества:

- Оперативные поставки широкого спектра электронных компонентов отечественного и импортного производства напрямую от производителей и с крупнейших мировых складов;
- Поставка более 17-ти миллионов наименований электронных компонентов;
- Поставка сложных, дефицитных, либо снятых с производства позиций;
- Оперативные сроки поставки под заказ (от 5 рабочих дней);
- Экспресс доставка в любую точку России;
- Техническая поддержка проекта, помощь в подборе аналогов, поставка прототипов;
- Система менеджмента качества сертифицирована по Международному стандарту ISO 9001;
- Лицензия ФСБ на осуществление работ с использованием сведений, составляющих государственную тайну;
- Поставка специализированных компонентов (Xilinx, Altera, Analog Devices, Intersil, Interpoint, Microsemi, Aeroflex, Peregrine, Syfer, Eurofarad, Texas Instrument, Miteq, Cobham, E2V, MA-COM, Hittite, Mini-Circuits, General Dynamics и др.);

Помимо этого, одним из направлений компании «ЭлектроПласт» является направление «Источники питания». Мы предлагаем Вам помощь Конструкторского отдела:

- Подбор оптимального решения, техническое обоснование при выборе компонента;
- Подбор аналогов;
- Консультации по применению компонента;
- Поставка образцов и прототипов;
- Техническая поддержка проекта;
- Защита от снятия компонента с производства.



#### Как с нами связаться

**Телефон:** 8 (812) 309 58 32 (многоканальный)

**Факс:** 8 (812) 320-02-42

**Электронная почта:** [org@eplast1.ru](mailto:org@eplast1.ru)

**Адрес:** 198099, г. Санкт-Петербург, ул. Калинина, дом 2, корпус 4, литера А.