

### CA Varistor Series

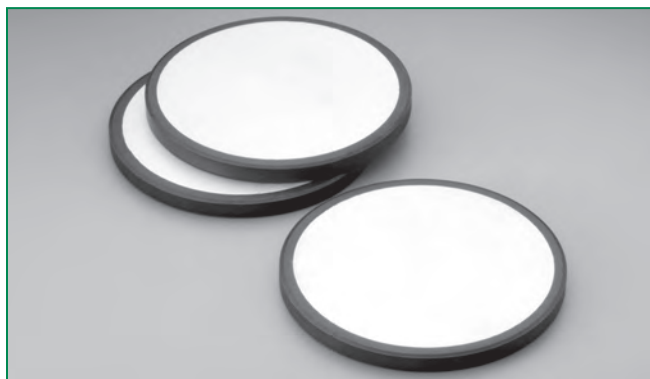

#### Description

The CA Series of transient surge suppressors are industrial high-energy disc varistors (MOVs) intended for special applications requiring unique electrical contact or packaging methods provided by the customer. The electrode finish of these devices is solderable and can also be used with pressure contacts. Discs of the same diameter may be stacked.

This series of industrial disc varistors are nominal 60mm diameter, with disc thickness ranging from 2.7mm to 32mm. The voltage range is 250V to 2800 V<sub>(AC)RMS</sub>.

For information on soldering considerations, refer to EC637 "Recommendations for Soldering Terminal Leads to MOV Varistor Discs."

#### Features

- Standard disc size nominal 60mm diameter
- Discs have edge passivation insulation
- High peak pulse current range 50000A to 70000A
- Very high-energy capability  $W_{tm}$  880J to 10000J

#### Absolute Maximum Ratings

• For ratings of individual members of a series, see Device Ratings and Specifications chart

Continuous	CA Series	Units
Steady State Applied Voltage:		
AC Voltage Range (V <sub>M(AC)RMS</sub> )	250 to 2800	V
DC Voltage Range (V <sub>M(DC)</sub> )	330 to 3500	V
Transient:		
Peak Pulse Current (I <sub>TM</sub> )		
For 8/20μs Current Wave(See Figure 2)	20,000 to 70,000	A
Single-Pulse Energy Range		
For 2ms Current Square Wave (W <sub>TM</sub> )	880 to 10,000	J
Operating Ambient Temperature Range (T <sub>A</sub> )	-55 to +85	°C
Storage Temperature Range (T <sub>STG</sub> )	- 55 to +85	°C
Temperature Coefficient (V) of Clamping Voltage (V <sub>C</sub> ) at Specified Test Current	<0.01	%/°C

**CAUTION:** Stresses above those listed in "Absolute Maximum Ratings" may cause permanent damage to the device. This is a stress only rating and operation of the device at these or any other conditions above those indicated in the operational sections of this specification is not implied.

### CA Series Ratings & Specifications

Part Number Device Branding	Size  (mm)	Maximum Rating (85°C)				Specifications (25°C)				
		Continuous		Transient		Varistor Voltage at 1mA DC Test Current			Max Clamping Volt V <sub>c</sub> at 200A Current (8/20µs)	Typical Capacitance  f = 1MHz
		V <sub>RMS</sub>	V <sub>DC</sub>	Energy (2ms)	Peak Current (8/20µs)					
		V <sub>M(AC)</sub>	V <sub>M(DC)</sub>	W <sub>TM</sub>	I <sub>TM</sub>	Min (V)	V <sub>NOM</sub> (V)	Max (V)	V <sub>c</sub> (A)	(pF)
V251CA60	60	250	330	880	50000	354	390	429	620	10000
V271CA60	60	275	369	950	50000	389	430	473	680	9000
V321CA60	60	320	420	1100	50000	462	510	561	760	7500
V421CA60	60	420	560	1500	70000	610	680	748	1060	6000
V481CA60	60	480	640	1600	70000	670	750	825	1160	5500
V511CA60	60	510	675	1800	70000	735	820	910	1300	5000
V571CA60	60	575	730	2100	70000	805	910	1000	1420	4500
V661CA60	60	660	850	2300	70000	940	1050	1160	1640	4000
V751CA60	60	750	970	2600	70000	1080	1200	1320	1880	3500
V881CA60	60	880	1150	3200	70000	1290	1500	1650	2340	2700
V112CA60	60	1100	1400	3800	70000	1620	1800	2060	2940	2200
V142CA60	60	1400	1750	5000	70000	2020	2200	2550	3600	1800
V172CA60	60	1700	2150	6000	70000	2500	2700	3030	4300	1500
V202CA60	60	2000	2500	7500	70000	2970	3300	3630	5200	1200
V242CA60	60	2400	3000	8800	70000	3510	3900	4290	6200	1000
V282CA60	60	2800	3500	10000	70000	4230	4700	5170	7400	800

NOTE: Average power dissipation of transients should not exceed 2.5W for CA60 discs.

### Power Dissipation Ratings

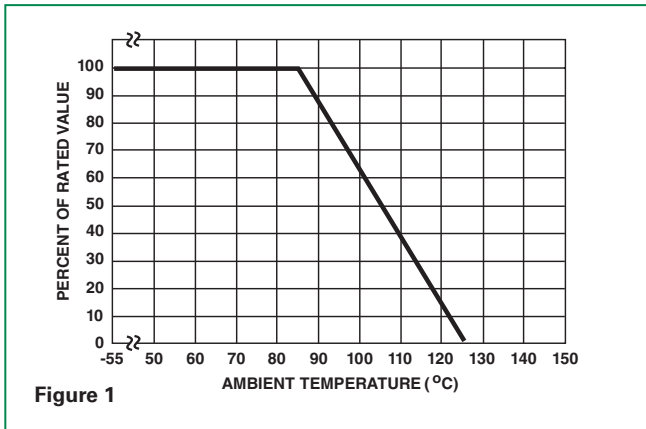

Should transients occur in rapid succession, the average power dissipation result is the energy (watt-seconds) per pulse times the number of pulses per second. The power so developed must be within the specifications shown on the Device Ratings and Specifications table for the specific device. Furthermore, the operating values need to be derated at high temperatures as shown in above. Because varistors can only dissipate a relatively small amount of average power they are, therefore, not suitable for repetitive applications that involve substantial amounts of average power dissipation.

### Peak Pulse Current Test Waveform

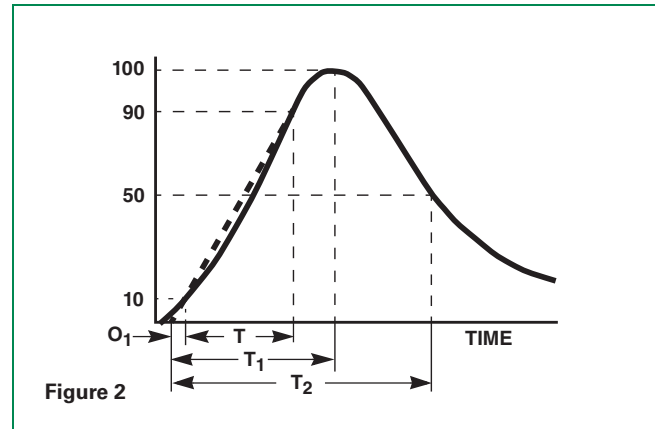

- O<sub>1</sub> = Virtual Origin of Wave
- T = Time from 10% to 90% of Peak
- T<sub>1</sub> = Rise Time = 1.25 x T
- T<sub>2</sub> = Decay Time

**Example** - For an 8/20 µs Current Waveform:

- 8µs = T<sub>1</sub> = Rise Time
- 20µs = T<sub>2</sub> = Decay Time

**Maximum Clamping Voltage for 60mm Parts**

V251CA60 - V881CA60

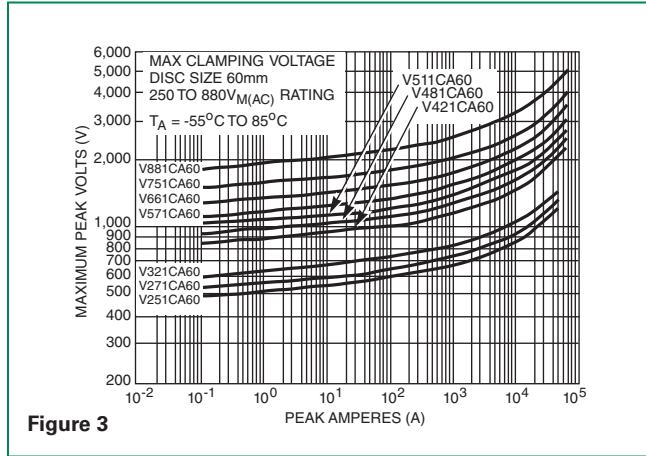

Figure 3

**Repetitive Surge Capability for 60mm Parts**

V251CA60 - V321CA60

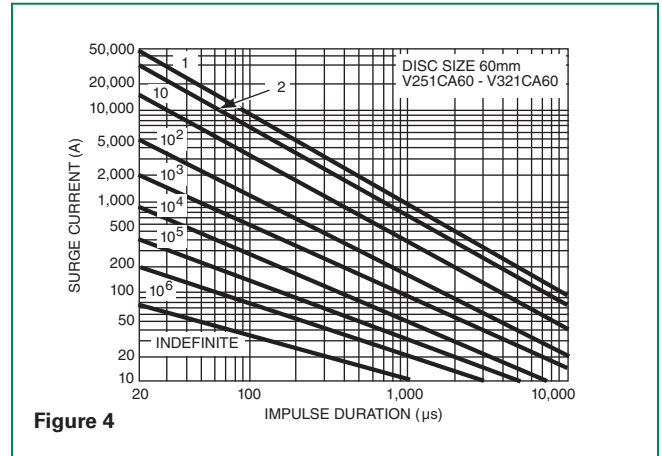

Figure 4

V112CA60 - V282CA60

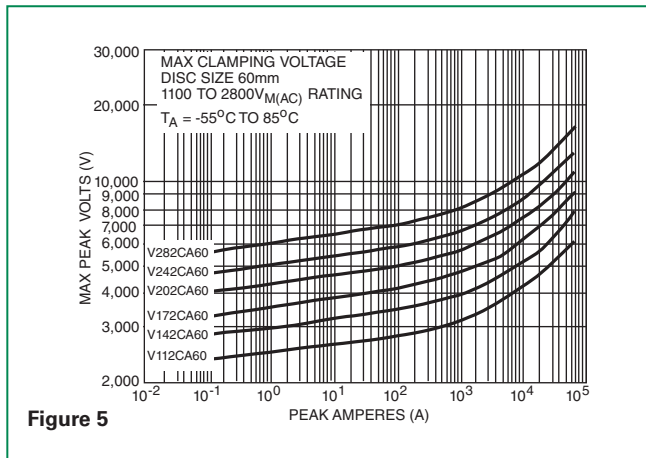

Figure 5

V421CA60 - V282CA60

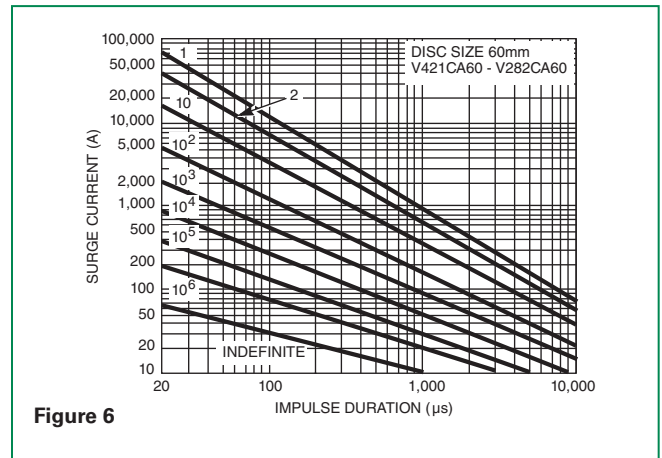

Figure 6

NOTE: If pulse ratings are exceeded, a shift of  $V_{NDC}$  (at specified current) of more than +/-10% could result. This type of shift, which normally results in a decrease of  $V_{NDC}$ , may result in the device not meeting the original published specifications, but does not prevent the device from continuing to function, and to provide ample protection.

### Physical Specifications

<b>Soldering Characteristics</b>	Solderability per MIL-STD-202, Method 208E
<b>Insulating Material</b>	glass passivation on edge only
<b>Device Labeling</b>	none

### Product Dimensions (mm)

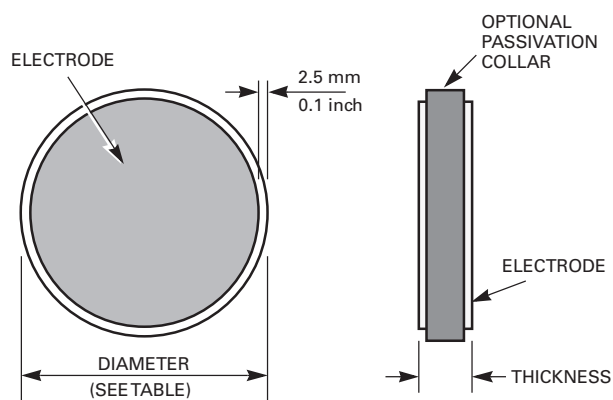

### Environmental Specifications

<b>Operating/Storage Temperature</b>	-55°C to +85°C
<b>Humidity Aging</b>	+85°C, 85% RH, 1000 hours +/-10% typical voltage change
<b>Thermal Shock</b>	+85°C to -55°C 10 times +/-10% typical voltage change
<b>Solvent Resistance</b>	MIL-STD-202, Method 215F
<b>Moisture Sensitivity</b>	Level 1, J-STD-020C

### Weight

Model Number	Typical Discweight (Grams)
V251CA60	39
V271CA60	42
V321CA60	50
V421CA60	66
V481CA60	71
V511CA60	80
V571CA60	88
V661CA60	101
V751CA60	116
V881CA60	141
V112CA60	178
V142CA60	220
V172CA60	265
V202CA60	317
V242CA60	377
V282CA60	450

Model Size	Disc Diameter			
	Millimeters		Inches	
	Min	Max	Min	Max
60	58.0	62.0	2.283	2.441

Model $V_{RMS}$ $V_{M(AC)}$	Disc Thickness			
	Millimeters		Inches	
	Min.	Max.	Min.	Max.
250	2.0	2.7	0.079	0.106
275	2.2	3.0	0.087	0.118
320	2.6	3.5	0.102	0.138
420	3.5	4.7	0.138	0.185
510	4.2	5.7	0.165	0.224
575	4.6	6.3	0.181	0.248
660	5.3	7.2	0.209	0.283
750	6.1	8.3	0.240	0.327
880	7.3	10.3	0.287	0.406
1100	9.2	13.0	0.362	0.512
1400	11.5	16.0	0.453	0.630
1700	14.0	19.0	0.551	0.748
2000	17.0	22.5	0.669	0.886
2400	20.0	27.0	0.787	1.063
2800	24.0	32.0	0.945	1.260

### Passivation Layer

The standard CA Series is supplied with passivation layer around the outside perimeter of the disc forming an electrical insulator as detailed in the dimensional drawing. For other options contact factory. (See Ordering Information)

### Encapsulated Recommendations

After lead attachment, the disc/lead assembly may be coated or encapsulated in a package to provide electrical insulation and isolation from environmental contamination as required by the application. Coating/Filler materials for containers may include silicones, polyurethanes, and some epoxy resins. Materials containing halogens, sulfides, or alkalines are not recommended.

### Stacking and Contact Pressure Recommendations

When applications require the stacking of CA60 discs, or when an electrical connection is made by pressure contacts, the pressure applied to the CA60 disc electrode surface should be minimum 2.2kgs (5 pounds) and maximum 4N/CM<sup>2</sup> (5.7LBs/IN<sup>2</sup>).

### Part Numbering System

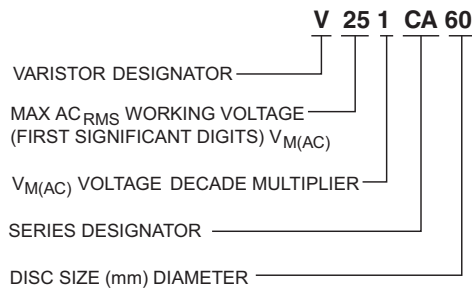

### Electrode Metallization

CA60 discs are supplied as standard with sintered Silver electrodes. For other available options please contact Littelfuse.

### Recommended Reflow Temperature Profile

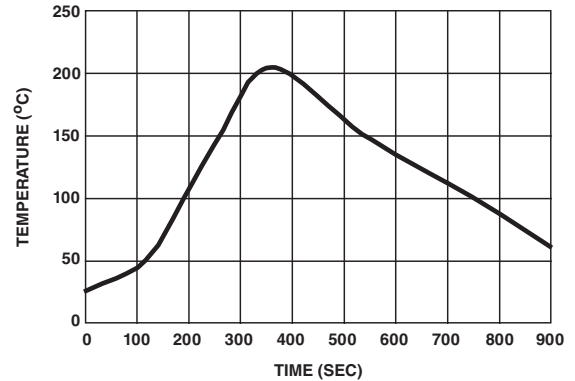

### Packaging and Shipping

The CA Series is supplied in bulk for shipment. Discs are packaged in compartmentalized cartons to protect from scratching or edge-chipping during shipment.

No branding or any other type of marking appears on the CA disc itself.

CA60 discs are supplied as standard with sintered Silver electrodes and glass passivation. For other available options please contact factory.



Компания «ЭлектроПласт» предлагает заключение долгосрочных отношений при поставках импортных электронных компонентов на взаимовыгодных условиях!

Наши преимущества:

- Оперативные поставки широкого спектра электронных компонентов отечественного и импортного производства напрямую от производителей и с крупнейших мировых складов;
- Поставка более 17-ти миллионов наименований электронных компонентов;
- Поставка сложных, дефицитных, либо снятых с производства позиций;
- Оперативные сроки поставки под заказ (от 5 рабочих дней);
- Экспресс доставка в любую точку России;
- Техническая поддержка проекта, помощь в подборе аналогов, поставка прототипов;
- Система менеджмента качества сертифицирована по Международному стандарту ISO 9001;
- Лицензия ФСБ на осуществление работ с использованием сведений, составляющих государственную тайну;
- Поставка специализированных компонентов (Xilinx, Altera, Analog Devices, Intersil, Interpoint, Microsemi, Aeroflex, Peregrine, Syfer, Eurofarad, Texas Instrument, Miteq, Cobham, E2V, MA-COM, Hittite, Mini-Circuits, General Dynamics и др.);

Помимо этого, одним из направлений компании «ЭлектроПласт» является направление «Источники питания». Мы предлагаем Вам помощь Конструкторского отдела:

- Подбор оптимального решения, техническое обоснование при выборе компонента;
- Подбор аналогов;
- Консультации по применению компонента;
- Поставка образцов и прототипов;
- Техническая поддержка проекта;
- Защита от снятия компонента с производства.



#### Как с нами связаться

**Телефон:** 8 (812) 309 58 32 (многоканальный)

**Факс:** 8 (812) 320-02-42

**Электронная почта:** [org@eplast1.ru](mailto:org@eplast1.ru)

**Адрес:** 198099, г. Санкт-Петербург, ул. Калинина, дом 2, корпус 4, литера А.