

CA Varistor Series

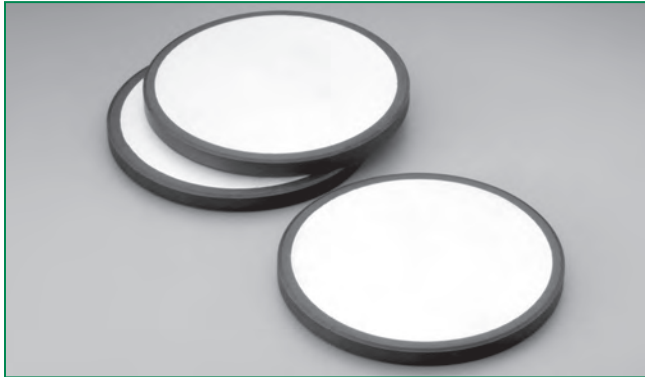

Description

The CA Series of transient surge suppressors are industrial high-energy disc varistors (MOVs) intended for special applications requiring unique electrical contact or packaging methods provided by the customer. The electrode finish of these devices is solderable and can also be used with pressure contacts. Discs of the same diameter may be stacked.

This series of industrial disc varistors are nominal 60mm diameter, with disc thickness ranging from 2.7mm to 32mm. The voltage range is 250V to 2800 V_{(AC)RMS}.

For information on soldering considerations, refer to EC637 "Recommendations for Soldering Terminal Leads to MOV Varistor Discs."

Features

- Standard disc size nominal 60mm diameter
- Discs have edge passivation insulation
- High peak pulse current range 50000A to 70000A
- Very high-energy capability W_{tm} 880J to 10000J

Absolute Maximum Ratings

• For ratings of individual members of a series, see Device Ratings and Specifications chart

| Continuous | CA Series | Units |
|---|------------------|-------|
| Steady State Applied Voltage: | | |
| AC Voltage Range ($V_{M(AC)RMS}$) | 250 to 2800 | V |
| DC Voltage Range ($V_{M(DC)}$) | 330 to 3500 | V |
| Transient: | | |
| Peak Pulse Current (I_{TM}) | | |
| For 8/20 μ s Current Wave(See Figure 2) | 20,000 to 70,000 | A |
| Single-Pulse Energy Range | | |
| For 2ms Current Square Wave (W_{TM}) | 880 to 10,000 | J |
| Operating Ambient Temperature Range (T_A) | -55 to +85 | °C |
| Storage Temperature Range (T_{STG}) | - 55 to +85 | °C |
| Temperature Coefficient (V) of Clamping Voltage (V_C) at Specified Test Current | <0.01 | %/°C |

CAUTION: Stresses above those listed in "Absolute Maximum Ratings" may cause permanent damage to the device. This is a stress only rating and operation of the device at these or any other conditions above those indicated in the operational sections of this specification is not implied.

CA Series Ratings & Specifications

| Part Number Device Branding | Size (mm) | Maximum Rating (85°C) | | | | Specifications (25°C) | | | | |
|--------------------------------|------------------|---------------------------|---------------------------|------------------------|-----------------------------|--|-------------------------|------------|--|--|
| | | Continuous | | Transient | | Varistor Voltage at 1mA DC Test Current | | | Max Clamping Volt V _c at 200A Current (8/20µs) | Typical Capacitance f = 1MHz |
| | | V _{RMS} | V _{DC} | Energy (2ms) | Peak Current (8/20µs) | | | | | |
| | | V _{M(AC)} (V) | V _{M(DC)} (V) | W _{TM} (J) | I _{TM} (A) | Min (V) | V _{NOM} (V) | Max (V) | V _c (A) | (pF) |
| V251CA60 | 60 | 250 | 330 | 880 | 50000 | 354 | 390 | 429 | 620 | 10000 |
| V271CA60 | 60 | 275 | 369 | 950 | 50000 | 389 | 430 | 473 | 680 | 9000 |
| V321CA60 | 60 | 320 | 420 | 1100 | 50000 | 462 | 510 | 561 | 760 | 7500 |
| V421CA60 | 60 | 420 | 560 | 1500 | 70000 | 610 | 680 | 748 | 1060 | 6000 |
| V481CA60 | 60 | 480 | 640 | 1600 | 70000 | 670 | 750 | 825 | 1160 | 5500 |
| V511CA60 | 60 | 510 | 675 | 1800 | 70000 | 735 | 820 | 910 | 1300 | 5000 |
| V571CA60 | 60 | 575 | 730 | 2100 | 70000 | 805 | 910 | 1000 | 1420 | 4500 |
| V661CA60 | 60 | 660 | 850 | 2300 | 70000 | 940 | 1050 | 1160 | 1640 | 4000 |
| V751CA60 | 60 | 750 | 970 | 2600 | 70000 | 1080 | 1200 | 1320 | 1880 | 3500 |
| V881CA60 | 60 | 880 | 1150 | 3200 | 70000 | 1290 | 1500 | 1650 | 2340 | 2700 |
| V112CA60 | 60 | 1100 | 1400 | 3800 | 70000 | 1620 | 1800 | 2060 | 2940 | 2200 |
| V142CA60 | 60 | 1400 | 1750 | 5000 | 70000 | 2020 | 2200 | 2550 | 3600 | 1800 |
| V172CA60 | 60 | 1700 | 2150 | 6000 | 70000 | 2500 | 2700 | 3030 | 4300 | 1500 |
| V202CA60 | 60 | 2000 | 2500 | 7500 | 70000 | 2970 | 3300 | 3630 | 5200 | 1200 |
| V242CA60 | 60 | 2400 | 3000 | 8800 | 70000 | 3510 | 3900 | 4290 | 6200 | 1000 |
| V282CA60 | 60 | 2800 | 3500 | 10000 | 70000 | 4230 | 4700 | 5170 | 7400 | 800 |

NOTE: Average power dissipation of transients should not exceed 2.5W for CA60 discs.

Power Dissipation Ratings

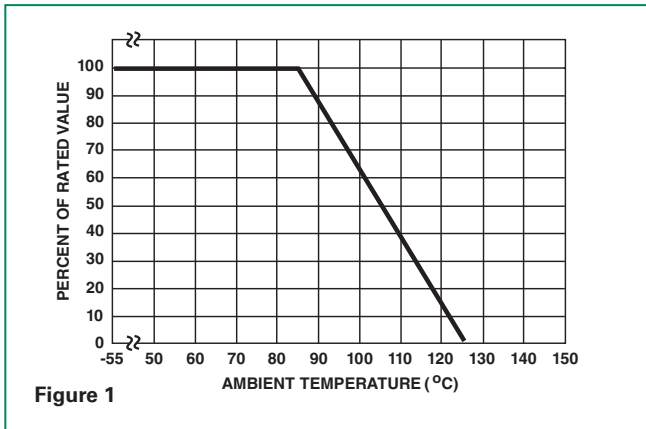

Figure 1

Should transients occur in rapid succession, the average power dissipation result is the energy (watt-seconds) per pulse times the number of pulses per second. The power so developed must be within the specifications shown on the Device Ratings and Specifications table for the specific device. Furthermore, the operating values need to be derated at high temperatures as shown in above. Because varistors can only dissipate a relatively small amount of average power they are, therefore, not suitable for repetitive applications that involve substantial amounts of average power dissipation.

Peak Pulse Current Test Waveform

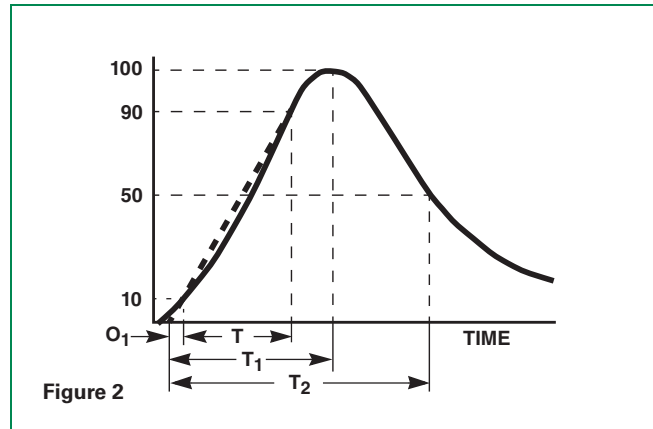

Figure 2

- O₁ = Virtual Origin of Wave
- T = Time from 10% to 90% of Peak
- T₁ = Rise Time = 1.25 x T
- T₂ = Decay Time

Example - For an 8/20 µs Current Waveform:

- 8µs = T₁ = Rise Time
- 20µs = T₂ = Decay Time

Maximum Clamping Voltage for 60mm Parts

V251CA60 - V881CA60

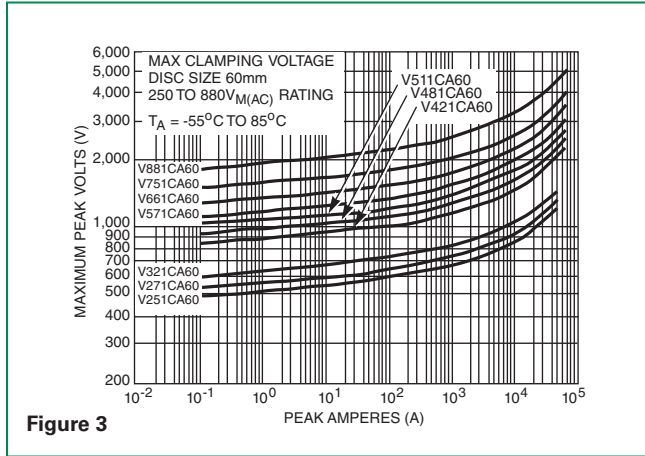

Figure 3

Repetitive Surge Capability for 60mm Parts

V251CA60 - V321CA60

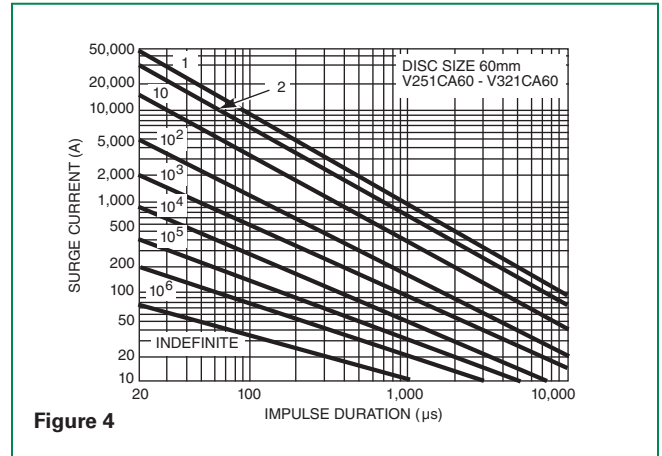

Figure 4

V112CA60 - V282CA60

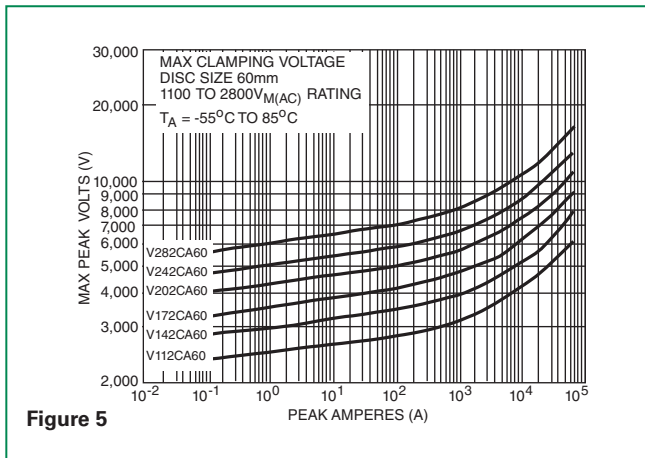

Figure 5

V421CA60 - V282CA60

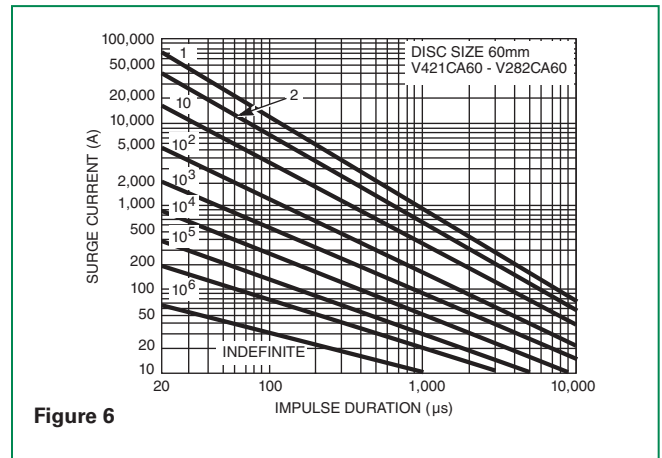

Figure 6

NOTE: If pulse ratings are exceeded, a shift of V_{NDC} (at specified current) of more than +/-10% could result. This type of shift, which normally results in a decrease of V_{NDC} , may result in the device not meeting the original published specifications, but does not prevent the device from continuing to function, and to provide ample protection.

Physical Specifications

| | |
|----------------------------------|--|
| Soldering Characteristics | Solderability per MIL-STD-202, Method 208E |
| Insulating Material | glass passivation on edge only |
| Device Labeling | none |

Product Dimensions (mm)

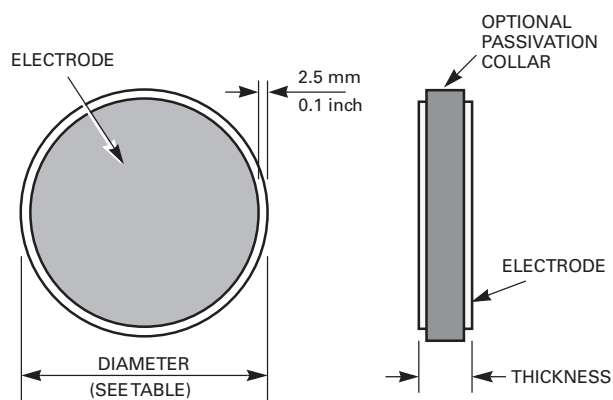

Environmental Specifications

| | |
|--------------------------------------|--|
| Operating/Storage Temperature | -55°C to +85°C |
| Humidity Aging | +85°C, 85% RH, 1000 hours +/-10% typical voltage change |
| Thermal Shock | +85°C to -55°C 10 times +/-10% typical voltage change |
| Solvent Resistance | MIL-STD-202, Method 215F |
| Moisture Sensitivity | Level 1, J-STD-020C |

Weight

| Model Number | Typical Discweight (Grams) |
|--------------|----------------------------|
| V251CA60 | 39 |
| V271CA60 | 42 |
| V321CA60 | 50 |
| V421CA60 | 66 |
| V481CA60 | 71 |
| V511CA60 | 80 |
| V571CA60 | 88 |
| V661CA60 | 101 |
| V751CA60 | 116 |
| V881CA60 | 141 |
| V112CA60 | 178 |
| V142CA60 | 220 |
| V172CA60 | 265 |
| V202CA60 | 317 |
| V242CA60 | 377 |
| V282CA60 | 450 |

| Model Size | Disc Diameter | | | |
|------------|---------------|------|--------|-------|
| | Millimeters | | Inches | |
| | Min | Max | Min | Max |
| 60 | 58.0 | 62.0 | 2.283 | 2.441 |

| Model V_{RMS} $V_{M(AC)}$ | Disc Thickness | | | |
|-----------------------------------|----------------|------|--------|-------|
| | Millimeters | | Inches | |
| | Min. | Max. | Min. | Max. |
| 250 | 2.0 | 2.7 | 0.079 | 0.106 |
| 275 | 2.2 | 3.0 | 0.087 | 0.118 |
| 320 | 2.6 | 3.5 | 0.102 | 0.138 |
| 420 | 3.5 | 4.7 | 0.138 | 0.185 |
| 510 | 4.2 | 5.7 | 0.165 | 0.224 |
| 575 | 4.6 | 6.3 | 0.181 | 0.248 |
| 660 | 5.3 | 7.2 | 0.209 | 0.283 |
| 750 | 6.1 | 8.3 | 0.240 | 0.327 |
| 880 | 7.3 | 10.3 | 0.287 | 0.406 |
| 1100 | 9.2 | 13.0 | 0.362 | 0.512 |
| 1400 | 11.5 | 16.0 | 0.453 | 0.630 |
| 1700 | 14.0 | 19.0 | 0.551 | 0.748 |
| 2000 | 17.0 | 22.5 | 0.669 | 0.886 |
| 2400 | 20.0 | 27.0 | 0.787 | 1.063 |
| 2800 | 24.0 | 32.0 | 0.945 | 1.260 |

Passivation Layer

The standard CA Series is supplied with passivation layer around the outside perimeter of the disc forming an electrical insulator as detailed in the dimensional drawing. For other options contact factory. (See Ordering Information)

Encapsulated Recommendations

After lead attachment, the disc/lead assembly may be coated or encapsulated in a package to provide electrical insulation and isolation from environmental contamination as required by the application. Coating/Filler materials for containers may include silicones, polyurethanes, and some epoxy resins. Materials containing halogens, sulfides, or alkalines are not recommended.

Stacking and Contact Pressure Recommendations

When applications require the stacking of CA60 discs, or when an electrical connection is made by pressure contacts, the pressure applied to the CA60 disc electrode surface should be minimum 2.2kgs (5 pounds) and maximum 4N/CM² (5.7LBs/IN²).

Part Numbering System

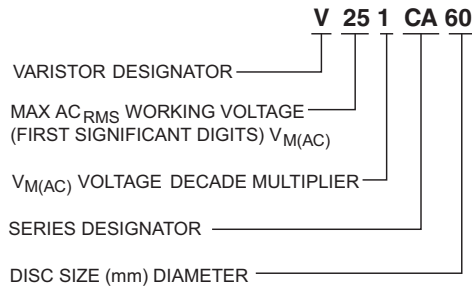

Electrode Metallization

CA60 discs are supplied as standard with sintered Silver electrodes. For other available options please contact Littelfuse.

Recommended Reflow Temperature Profile

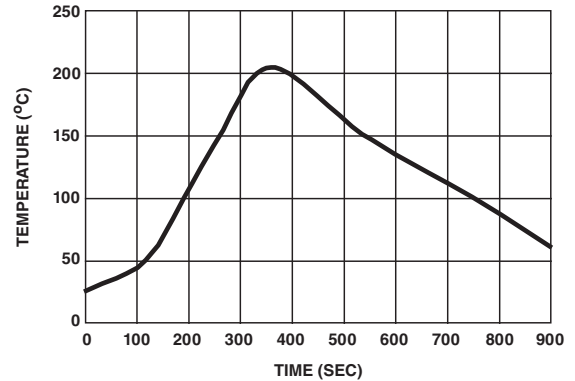

Packaging and Shipping

The CA Series is supplied in bulk for shipment. Discs are packaged in compartmentalized cartons to protect from scratching or edge-chipping during shipment.

No branding or any other type of marking appears on the CA disc itself.

CA60 discs are supplied as standard with sintered Silver electrodes and glass passivation. For other available options please contact factory.



Компания «ЭлектроПласт» предлагает заключение долгосрочных отношений при поставках импортных электронных компонентов на взаимовыгодных условиях!

Наши преимущества:

- Оперативные поставки широкого спектра электронных компонентов отечественного и импортного производства напрямую от производителей и с крупнейших мировых складов;
- Поставка более 17-ти миллионов наименований электронных компонентов;
- Поставка сложных, дефицитных, либо снятых с производства позиций;
- Оперативные сроки поставки под заказ (от 5 рабочих дней);
- Экспресс доставка в любую точку России;
- Техническая поддержка проекта, помощь в подборе аналогов, поставка прототипов;
- Система менеджмента качества сертифицирована по Международному стандарту ISO 9001;
- Лицензия ФСБ на осуществление работ с использованием сведений, составляющих государственную тайну;
- Поставка специализированных компонентов (Xilinx, Altera, Analog Devices, Intersil, Interpoint, Microsemi, Aeroflex, Peregrine, Syfer, Eurofarad, Texas Instrument, Miteq, Cobham, E2V, MA-COM, Hittite, Mini-Circuits, General Dynamics и др.);

Помимо этого, одним из направлений компании «ЭлектроПласт» является направление «Источники питания». Мы предлагаем Вам помощь Конструкторского отдела:

- Подбор оптимального решения, техническое обоснование при выборе компонента;
- Подбор аналогов;
- Консультации по применению компонента;
- Поставка образцов и прототипов;
- Техническая поддержка проекта;
- Защита от снятия компонента с производства.



Как с нами связаться

Телефон: 8 (812) 309 58 32 (многоканальный)

Факс: 8 (812) 320-02-42

Электронная почта: org@eplast1.ru

Адрес: 198099, г. Санкт-Петербург, ул. Калинина, дом 2, корпус 4, литера А.