

UPGRADE

Surface Mount Type

ZA series **V** type

High temperature lead-free reflow



Hybrid

Features

- Endurance : 10000 h at 105 °C
- Low ESR and high ripple current (70 % over, Lower ESR than current V-FP)
- High voltage (to 80 V)
- Equivalent to conductive polymer type aluminum electrolytic capacitor (There are little characteristics change by temperature and frequency)
- Vibration-proof product is available upon request. New lineup of φ6.3 product. (φ6.3, φ8, φ10)
- AEC-Q200 compliant
- RoHS compliant

Specifications

Size code	C	D	D8	F	G
Category temp. range	-55 °C to +105 °C				
Rated voltage range	25 V to 50 V	25 V to 63 V		25 V to 80 V	
Nominal cap.range	10 μF to 33 μF	10 μF to 56 μF	22 μF to 100 μF	22 μF to 220 μF	33 μF to 330 μF
Capacitance tolerance	±20 % (120 Hz / +20 °C)				
DC leakage current	I ≤ 0.01 CV or 3 (μA) After 2 minutes (whichever is greater)				
Dissipation factor (tan δ)	Please see the attached characteristics list				
Endurance	+105 °C ± 2 °C, 10000 h, apply the rated ripple current without exceeding the rated voltage.				
	Capacitance change	Within ±30% of the initial value			
	Dissipation factor (tan δ)	≤ 200 % of the initial limit			
	ESR	≤ 200 % of the initial limit			
	DC leakage current	Within the initial limit			
ESR after endurance (Ω / 100 kHz)(-40 °C)	Size code				
	C	D	D8	F	G
	2.0	1.4	0.8	0.4	0.3
Shelf life	After storage for 1000 hours at +105 °C ± 2 °C with no voltage applied and then being stabilized at +20 °C, capacitors shall meet the limits specified in endurance. (With voltage treatment)				
Damp heat (Load)	+85 °C ± 2 °C, 85 % to 90 %, 2000 h, rated voltage applied				
	Capacitance change	Within ±30% of the initial value			
	Dissipation factor (tan δ)	≤ 200 % of the initial limit			
	ESR	≤ 200 % of the initial limit			
Resistance to soldering heat	After reflow soldering and then being stabilized at +20 °C, capacitors shall meet the following limits.				
	Capacitance change	Within ±10% of the initial value			
	Dissipation factor (tan δ)	Within the initial limit			
	DC leakage current	Within the initial limit			

Marking

Example : 25 V 33 μF
Marking color : BLACK

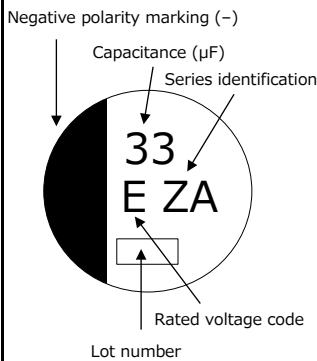

R. voltage code	Unit : V
E	25
V	35
H	50
J	63
K	80

Dimensions (not to scale)

[Standard]

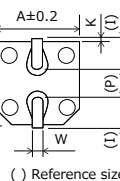
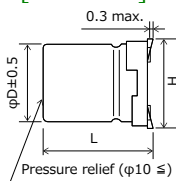

Size code	φD	L	A, B	H max.	I	W	P	K
C	5.0	5.8±0.3	5.3	6.5	2.2	0.65±0.1	1.5	0.35 ^{+0.15} / _{-0.20}
D	6.3	5.8±0.3	6.6	7.8	2.6	0.65±0.1	1.8	0.35 ^{+0.15} / _{-0.20}
D8	6.3	7.7±0.3	6.6	7.8	2.6	0.65±0.1	1.8	0.35 ^{+0.15} / _{-0.20}
F	8.0	10.2±0.3	8.3	10	3.4	0.90±0.2	3.1	0.70±0.2
G	10.0	10.2±0.3	10.3	12.0	3.5	0.90±0.2	4.6	0.70±0.2

[Vibration-proof product]

< Size code : D, D8 >

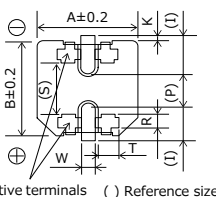
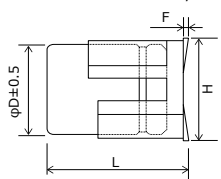

< Size code : F, G >

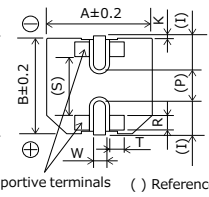
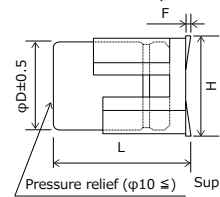

Size code	φD	L	A, B	H max.	F	I	W	P	K	R	S	T
D	6.3	6.1±0.3	6.6	7.8	0 to +0.15	2.4	0.65±0.1	2.2	0.35 ^{+0.15} / _{-0.20}	1.1±0.2	3.3	1.05±0.2
D8	6.3	8.0±0.3	6.6	7.8	0 to +0.15	2.4	0.65±0.1	2.2	0.35 ^{+0.15} / _{-0.20}	1.1±0.2	3.3	1.05±0.2
F	8.0	10.5±0.3	8.3	10.0	0 to +0.15	3.4	1.2±0.2	3.1	0.70±0.2	0.70±0.2	5.3	1.3±0.2
G	10.0	10.5±0.3	10.3	12.0	0 to +0.15	3.5	1.2±0.2	4.6	0.70±0.2	0.70±0.2	6.9	1.3±0.2

Characteristics list

Endurance : 105 °C 10000 h

Rated voltage (V)	Capacitance (±20 %) (μF)	Case size (mm)			Size code	Specification			Part number		Min. packaging q'ty
		φD	L			Ripple current*1 (mA rms)	ESR*2 (mΩ)	tan δ*3	Standard Product	Vibration-proof product	Taping (pcs)
			Standard	Vibration-proof							
25	NEW 22	5.0	5.8	-	C	900	80	0.14	EEHZA1E220R	-	1000
	33	5.0	5.8	-	C	900	80	0.14	EEHZA1E330R	-	1000
	NEW 47	6.3	5.8	6.1	D	1300	50	0.14	EEHZA1E470P	EEHZA1E470V	1000
	56	6.3	5.8	6.1	D	1300	50	0.14	EEHZA1E560P	EEHZA1E560V	1000
	NEW 68	6.3	7.7	8.0	D8	2000	30	0.14	EEHZA1E680XP	EEHZA1E680XV	900
	100	6.3	7.7	8.0	D8	2000	30	0.14	EEHZA1E101XP	EEHZA1E101XV	900
	NEW 150	8.0	10.2	10.5	F	2300	27	0.14	EEHZA1E151P	EEHZA1E151V	500
	220	8.0	10.2	10.5	F	2300	27	0.14	EEHZA1E221P	EEHZA1E221V	500
35	330	10.0	10.2	10.5	G	2500	20	0.14	EEHZA1E331P	EEHZA1E331V	500
	NEW 10	5.0	5.8	-	C	900	100	0.12	EEHZA1V100R	-	1000
	22	5.0	5.8	-	C	900	100	0.12	EEHZA1V220R	-	1000
	27	6.3	5.8	6.1	D	1300	60	0.12	EEHZA1V270P	EEHZA1V270V	1000
	NEW 33	6.3	5.8	6.1	D	1300	60	0.12	EEHZA1V330P	EEHZA1V330V	1000
	47	6.3	5.8	6.1	D	1300	60	0.12	EEHZA1V470P	EEHZA1V470V	1000
	68	6.3	7.7	8.0	D8	2000	35	0.12	EEHZA1V680XP	EEHZA1V680XV	900
	NEW 100	8.0	10.2	10.5	F	2300	27	0.12	EEHZA1V101P	EEHZA1V101V	500
50	150	8.0	10.2	10.5	F	2300	27	0.12	EEHZA1V151P	EEHZA1V151V	500
	NEW 220	10.0	10.2	10.5	G	2500	20	0.12	EEHZA1V221P	EEHZA1V221V	500
	270	10.0	10.2	10.5	G	2500	20	0.12	EEHZA1V271P	EEHZA1V271V	500
	10	5.0	5.8	-	C	750	120	0.10	EEHZA1H100R	-	1000
	22	6.3	5.8	6.1	D	1100	80	0.10	EEHZA1H220P	EEHZA1H220V	1000
	33	6.3	7.7	8.0	D8	1600	40	0.10	EEHZA1H330XP	EEHZA1H330XV	900
	NEW 47	8.0	10.2	10.5	F	1800	30	0.10	EEHZA1H470P	EEHZA1H470V	500
	68	8.0	10.2	10.5	F	1800	30	0.10	EEHZA1H680P	EEHZA1H680V	500
63	100	10.0	10.2	10.5	G	2000	28	0.10	EEHZA1H101P	EEHZA1H101V	500
	10	6.3	5.8	6.1	D	1000	120	0.08	EEHZA1J100P	EEHZA1J100V	1000
	22	6.3	7.7	8.0	D8	1500	80	0.08	EEHZA1J220XP	EEHZA1J220XV	900
	33	8.0	10.2	10.5	F	1700	40	0.08	EEHZA1J330P	EEHZA1J330V	500
	NEW 47	8.0	10.2	10.5	F	1700	40	0.08	EEHZA1J470P	EEHZA1J470V	500
	56	10.0	10.2	10.5	G	1800	30	0.08	EEHZA1J560P	EEHZA1J560V	500
	NEW 68	10.0	10.2	10.5	G	1800	30	0.08	EEHZA1J680P	EEHZA1J680V	500
	NEW 82	10.0	10.2	10.5	G	1800	30	0.08	EEHZA1J820P	EEHZA1J820V	500
80	22	8.0	10.2	10.5	F	1550	45	0.08	EEHZA1K220P	EEHZA1K220V	500
	33	10.0	10.2	10.5	G	1700	36	0.08	EEHZA1K330P	EEHZA1K330V	500

*1: Ripple current (100 kHz / +105 °C) *2: ESR (100 kHz / +20 °C) *3: tan δ (120 Hz / +20 °C)

◆ Please refer to the page of "Reflow profile" and "The taping dimensions".

◆ The dimensions of the vibration-proof products, please refer to the page of the mounting specification.

Frequency correction factor for ripple current

Rated capacitance (C)	Frequency (f)	100 Hz ≤ f < 200 Hz	200 Hz ≤ f < 300 Hz	300 Hz ≤ f < 500 Hz	500 Hz ≤ f < 1 kHz
C < 47 μF 47 μF ≤ C < 150 μF 150 μF ≤ C	Correction factor	0.10	0.10	0.15	0.20
		0.15	0.20	0.25	0.30
		0.15	0.25	0.25	0.30
C < 47 μF 47 μF ≤ C < 150 μF 150 μF ≤ C	Correction factor	0.30	0.40	0.45	0.50
		0.40	0.45	0.55	0.60
		0.45	0.50	0.60	0.65
C < 47 μF 47 μF ≤ C < 150 μF 150 μF ≤ C	Correction factor	0.60	0.65	0.70	0.75
		0.70	0.75	0.80	0.80
		0.75	0.80	0.85	0.85
C < 47 μF 47 μF ≤ C < 150 μF 150 μF ≤ C	Correction factor	0.80	0.85	1.00	1.05
		0.85	0.90	1.00	1.00
		0.85	0.90	1.00	1.00

Guidelines and precautions regarding the technical information and use of our products described in this online catalog.

- If you want to use our products described in this online catalog for applications requiring special qualities or reliability, or for applications where the failure or malfunction of the products may directly jeopardize human life or potentially cause personal injury (e.g. aircraft and aerospace equipment, traffic and transportation equipment, combustion equipment, medical equipment, accident prevention, anti-crime equipment, and/or safety equipment), it is necessary to verify whether the specifications of our products fit to such applications. Please ensure that you will ask and check with our inquiry desk as to whether the specifications of our products fit to such applications use before you use our products.
- The quality and performance of our products as described in this online catalog only apply to our products when used in isolation. Therefore, please ensure you evaluate and verify our products under the specific circumstances in which our products are assembled in your own products and in which our products will actually be used.
- If you use our products in equipment that requires a high degree of reliability, regardless of the application, it is recommended that you set up protection circuits and redundancy circuits in order to ensure safety of your equipment.
- The products and product specifications described in this online catalog are subject to change for improvement without prior notice. Therefore, please be sure to request and confirm the latest product specifications which explain the specifications of our products in detail, before you finalize the design of your applications, purchase, or use our products.
- The technical information in this online catalog provides examples of our products' typical operations and application circuits. We do not guarantee the non-infringement of third party's intellectual property rights and we do not grant any license, right, or interest in our intellectual property.
- If any of our products, product specifications and/or technical information in this online catalog is to be exported or provided to non-residents, the laws and regulations of the exporting country, especially with regard to security and export control, shall be observed.

<Regarding the Certificate of Compliance with the EU RoHS Directive/REACH Regulations>

- The switchover date for compliance with the RoHS Directive/REACH Regulations varies depending on the part number or series of our products.
- When you use the inventory of our products for which it is unclear whether those products are compliant with the RoHS Directive/REACH Regulation, please select "Sales Inquiry" in the website inquiry form and contact us.

We do not take any responsibility for the use of our products outside the scope of the specifications, descriptions, guidelines and precautions described in this online catalog.

Notices

■ Applicable laws and regulations

- This product complies with the RoHS Directive (Restriction of the use of certain hazardous substances in electrical and electronic equipment (DIRECTIVE 2011/65/EU and (EU)2015/863)).
- No Ozone Depleting Chemicals(ODC's), controlled under the Montreal Protocol Agreement, are used in producing this product.
We do not use PBBs or PBDEs as brominated flame retardants.
- Export procedure which followed export related regulations, such as foreign exchange and a foreign trade method, on the occasion of export of this product.
- These products are not dangerous goods on the transportation as identified by UN(United Nations) numbers or UN classification.

■ Limited applications

- This capacitor is designed to be used for electronics circuits such as audio/visual equipment, home appliances, computers and other office equipment, optical equipment, measuring equipment.
- High reliability and safety are required [be / a possibility that incorrect operation of this product may do harm to a human life or property] more. When use is considered by the use, the delivery specifications which suited the use separately need to be exchanged.

■ Intellectual property rights and licenses

- The technical information in this specification provides examples of our products' typical operations and application circuits. We do not guarantee the non-infringement of third party's intellectual property rights and we do not grant any license, right, or interest in our intellectual property.

Items to be observed

■ For specification

- This specification guarantees the quality and performance of the product as individual components. The durability differs depending on the environment and the conditions of usage. Before use, check and evaluate their compatibility with actual conditions when installed in the products. When safety requirements cannot be satisfied in your technical examination, inform us immediately.
- Do not use the products beyond the specifications described in this document.

■ Upon application to products where safety is regarded as important

Install the following systems for a failsafe design to ensure safety if these products are to be used in equipment where a defect in these products may cause the loss of human life or other signification damage, such as damage to vehicles (automobile, train, vessel), traffic lights, medical equipment, aerospace equipment, electric heating appliances, combustion/ gas equipment, rotating rotating equipment, and disaster/crime prevention equipment.

- (1) The system is equipped with a protection circuit and protection device.
- (2) The system is equipped with a redundant circuit or other system to prevent an unsafe status in the event of a single fault.

■ Conditions of use

- Before using the products, carefully check the effects on their quality and performance, and determined whether or not they can be used. These products are designed and manufactured for general-purpose and standard use in general electronic equipment. These products are not intended for use in the following special conditions.
 - (1) In liquid, such as Water, Oil, Chemicals, or Organic solvent.
 - (2) In direct sunlight, outdoors, or in dust.
 - (3) In vapor, such as dew condensation water of resistive element, or water leakage, salty air, or air with a high concentration corrosive gas, such as Cl₂, H₂S, NH₃, SO₂, or NO_x.
 - (4) In an environment where strong static electricity or electromagnetic waves exist.
 - (5) Mounting or placing heat-generating components or inflammables, such as vinyl-coated wires, near these products.
 - (6) Sealing or coating of these products or a printed circuit board on which these products are mounted, with resin and other material.
 - (7) Using solvent, water or water-soluble cleaner for flux cleaning agent after soldering. (In particular, when using water or a water-soluble cleaning agent, be careful not to leave water residues)
 - (8) Using in the atmosphere where strays acid or alkaline.
 - (9) Using in the atmosphere where there are excessive vibration and shock.
- Please arrange circuit design for preventing impulse or transitional voltage.
Do not apply voltage, which exceeds the full rated voltage when the capacitors receive impulse voltage, instantaneous high voltage, high pulse voltage etc.
- Our products there is a product are using an electrolyte solution. Therefore, misuse can result in rapid deterioration of characteristics and functions of each product. Electrolyte leakage damages printed circuit and affects performance, characteristics, and functions of customer system.

! Application guidelines (Hybrid)

1. Circuit design

1.1 Operating temperature and frequency

Electrical characteristics of the capacitor are likely to change due to variation in temperature and/or frequency. Circuit designers should take these changes into consideration.

(1) Effects of operating temperature on electrical parameters

At higher temperatures : leakage current and capacitance increase while equivalent series resistance (ESR) decreases.

At lower temperatures : leakage current and capacitance decrease while equivalent series resistance (ESR) increases.

(2) Effects of frequency on electrical parameters

At higher frequencies : capacitance and impedance decrease while tan d increases.

At lower frequencies : heat generated by ripple current will rise due to an increase in equivalent series resistance (ESR).

1.2 Operating temperature and life expectancy

(1) Expected life is affected by operating temperature. Generally, each 10 °C reduction in temperature will double the expected life. Use capacitors at the lowest possible temperature below the upper category temperature.

(2) If operating temperatures exceed the upper category limit, rapid deterioration of electrical parameter will occur and irreversible damage will result.

Check for the maximum capacitor operating temperatures including ambient temperature, internal capacitor temperature rise due to ripple current, and the effects of radiated heat from power transistors, IC's or resistors.

Avoid placing components, which could conduct heat to the capacitor from the back side of the circuit board.

(3) The formula for calculating expected life at lower operating temperatures is as follows ;

$$L_2 = L_1 \times 2^{\frac{T_1 - T_2}{10}}$$

L₁ : Guaranteed life (h) at temperature, T₁ °C

L₂ : Expected life (h) at temperature, T₂ °C

T₁ : Upper category temperature + temperature rise due to rated ripple current (°C)

T₂ : Actual operating temperature, ambient temperature + temperature rise due to ripple current (°C)

(4) Please use according to the lifetime as noted in this specification. Using products beyond end of the lifetime may change characteristics rapidly, short-circuit, operate pressure relief vent, or leak electrolyte.

1.3 Common application conditions to avoid

The following misapplication load conditions will cause rapid deterioration of a capacitor's electrical parameters. In addition, rapid heating and gas generation within the capacitor can occur, causing the pressure relief vent to operate and resultant leakage of electrolyte. Under extreme conditions, explosion and fire ignition could result. The leaked electrolyte is combustible and electrically conductive.

(1) Reverse voltage

DC capacitors have polarity. Therefore, please do not apply the reverse voltage. Verify correct polarity before insertion.

(2) Charge / Discharge applications

Standard capacitors are not suitable for use in repeating charge/discharge applications. For charge/discharge applications, consult us with your actual application condition.

For rush current, please do not exceed 100 A.

(3) ON-OFF circuit

Do not use capacitors in circuit where ON-OFF switching is repeated more than 10000 times/per day.

In case of applying to the theses ON-OFF circuit, consult with us about circuit condition and so on.

(4) Over voltage

Do not apply voltages exceeding the maximum specified rated voltage. Voltages up to the surge voltage rating are acceptable for short periods of time.

Ensure that the sum of the DC voltage and the superimposed AC ripple voltage does not exceed the rated voltage.

(5) Ripple current

Do not apply ripple currents exceeding the maximum specified value. For high ripple current applications, use a capacitor designed for high ripple currents. In addition, consult us if the applied ripple current is to be higher than the maximum specified value. Ensure that rated ripple currents that superimposed on low DC bias voltages do not cause reverse voltage conditions.

Even if it is within a rated ripple current, in case the practical use is over the pre described endurance lifetime, it causes the increase of deterioration of ESR characteristic and the internal generation heat by ripple current. Due to this, there is some possibility of vent open, bulging of sleeve and rubber, electrolyte leakage, and shot circuit, explosion and ignition in the worst case.

1.4 Using two or more capacitors in parallel

The circuit resistance can closely approximate the series resistance of the capacitor, causing an imbalance of ripple current loads within the capacitors. Careful wiring methods can minimize the possible application of an excessive ripple current to a capacitor.

Moreover, please do not use it in series.

1.5 Capacitor mounting considerations

(1) Double-sided circuit boards

Avoid wiring pattern runs, which pass between the mounted capacitor and the circuit board.

(2) Clearance for case mounted pressure relief ($\geq \phi 10$ mm)

Capacitors with case mounted pressure relief require sufficient clearance to allow for proper pressure relief operation.

The minimum clearance are dependent on capacitor diameters as follows.

- $\geq \phi 10$ mm : 2 mm minimum

(3) Wiring near the pressure relief ($\geq \phi 10$ mm)

Avoid locating high voltage or high current wiring or circuit board paths above the pressure relief.

Flammable, high temperature gas that exceeds 100 °C may be released which could dissolve the wire insulation and ignite.

(4) Circuit board patterns under the capacitor

Avoid circuit board runs under the capacitor, as an electrical short can occur due to an electrolyte leakage.

1.6 Electrical isolation of the capacitor

Completely isolate the capacitor as follows.

- Between the cathode and the case and between the anode terminal and other circuit paths.

1.7 Capacitor coating

The laminate coating is intended for marking and identification purposes and is not meant to electrically insulate the capacitor.

2. Capacitor handling techniques

2.1 Considerations before using

(1) Capacitors have a finite life. Do not reuse or recycle capacitors from used equipment.

(2) Transient recovery voltage may be generated in the capacitor due to dielectric absorption.

If required, this voltage can be discharged with a resistor with a value of about 1 k Ω .

(3) Capacitors stored for a long period of time may exhibit an increase in leakage current.

This can be corrected by gradually applying rated voltage in series with a resistor of approximately 1 k Ω .

(4) If capacitors are dropped, they can be damaged mechanically or electrically. Avoid using dropped capacitors.

(5) Dented or crushed capacitors should not be used.

The seal integrity can be damaged and loss of electrolyte/ shortened life can result.

2.2 Capacitor insertion

(1) Verify the correct capacitance and rated voltage of the capacitor.

(2) Verify the correct polarity of the capacitor before insertion.

(3) Verify the correct terminal dimension and land pattern size before mount to avoid stress on the terminals.

(4) Excessive mounting pressure can cause high leakage current, short circuit, or disconnection.

2.3 Reflow soldering

(1) Surface-mount type capacitor are exclusively for reflow soldering.

When reflow solder is used an ambient heat condition system such as the simultaneous use of infrared and hot-air is recommended.

(2) Observe proper soldering conditions (temperature, time, etc.). Do not exceed the specified limits.

If the peak temperature is high or if the heating time is long, it may cause deterioration of the electrical characteristics and life characteristics.

Recommended soldering condition is a guideline for ensuring the basic characteristics of the components, but not for the stable soldering conditions. Conditions for proper soldering should be set up according to individual conditions.

* The Temperature on capacitor top shall be measured by using thermal couple that is fixed firmly by epoxy glue.

(3) In case of use in 2 times reflow, 2nd reflow must be done when the capacitor's temperature return back to normal level.

(4) In our recommended reflow condition, the case discoloration and the case swelling might be slightly generated. But please acknowledge that these two phenomena do not influence the reliability of the product.

(5) The crack on top marking might be occurred by reflow heat stress.

But please acknowledge that it does not influence the reliability of the product.

(6) VPS (Vapor Phase Soldering) reflow can cause significant characteristics change and/ or mounting failure due to deformation by acute temperature rise.

VPS is acceptable provided that the process does not exceed recommended reflow profile and temperature rise is less than 3 degC/sec. Please contact Panasonic for detailed conditions.

2.4 Manual soldering

- (1) Observe temperature and time soldering specifications or do not exceed temperature of 350 °C for 3 seconds or less.
- (2) If a soldered capacitor must be removed and reinserted, avoid excessive stress on the capacitor leads.
- (3) Avoid physical contacts between the tip of the soldering iron and capacitors to prevent or capacitor failure.

2.5 Capacitor handling after soldering

- (1) Avoid moving the capacitor after soldering to prevent excessive stress on the lead wires where they enter the seal. The capacitor may break from element portion due to a torque at outer rim, causing a large stress to terminals.
- (2) Do not use the capacitor as a handle when moving the circuit board assembly. The total weight of the board would apply to element portion through terminals, and the capacitor may break.
- (3) Avoid striking the capacitor after assembly to prevent failure due to excessive shock. The capacitor may break due to excessive shock or load above specified range.

2.6 Circuit board cleaning

- (1) Circuit boards can be immersed or ultrasonically cleaned using suitable cleaning solvents for up to 5 minutes and up to 60 °C maximum temperatures. The boards should be thoroughly rinsed and dried. The use of ozone depleting cleaning agents is not recommended for the purpose of protecting our environment.

【Target solvent】

Pine Alpha ST-100S, Aqua Cleaner 210SEP, Clean-thru 750H / 750L / 710M, Sunelec B-12, Sunelec B-12, Cold Cleaner P3-375, Techno Cleaner 219, DK Be-clear CW-5790, Telpene Cleaner EC-7R, Technocare FRW-17 / FRW-1 / FRV-1

- (2) Avoid using the following solvent groups unless specifically allowed in the specification ;
 - (a) Halogenated cleaning solvents : except for solvent resistant capacitor types, halogenated solvents can permeate the seal and cause internal capacitor corrosion and failure.
For solvent resistant capacitors, carefully follow the temperature and time requirements based on the specification. 1,1,1-trichloroethane should never be used on any aluminum electrolytic capacitor.
 - (b) Alkaline solvents : could react and dissolve the aluminum case.
 - (c) Petroleum based solvents : deterioration of the rubber seal could result.
 - (d) Xylene : deterioration of the rubber seal could result.
 - (e) Acetone : removal of the ink markings on the vinyl sleeve could result.
 - (3) A thorough drying after cleaning is required to remove residual cleaning solvents that may be trapped between the capacitor and the circuit board. Avoid drying temperatures, which exceed the upper category temperature of the capacitor.
 - (4) Monitor the contamination levels of the cleaning solvents during use in terms of electrical conductivity, pH, specific gravity, or water content.
Chlorine levels can rise with contamination and adversely affect the performance of the capacitor.
Control the flux density in the cleaning agent to be less than 2 mass%.
 - (5) Depending on the cleaning method, the marking on a capacitor may be erased or blurred.
- ※ Please consult us if you are not certain about acceptable cleaning solvents or cleaning methods.

2.7 Mounting adhesives and coating agents

When using mounting adhesives or coating agents to control humidity, avoid using materials containing halogenated solvents.

Also, avoid the use of chloroprene based polymers.

Harden on dry adhesive or coating agents well lest the solvent should be left.

After applying adhesives or coatings, dry thoroughly to prevent residual solvents from being trapped between the capacitor and the circuit board.

2.8 Fumigation

In exporting electronic appliances with aluminum electrolytic capacitors, in some cases fumigation treatment using such halogen compound as methyl bromide is conducted for wooden boxes.

If such boxes are not dried well, the halogen left in the box is dispersed while transported and enters in the capacitors inside.

This possibly causes electrical corrosion of the capacitors. Therefore, after performing fumigation and drying make sure that no halogen is left.

Don't perform fumigation treatment to the whole electronic appliances packed in a box.

Leave more than 1/3 of the sealing portion open, and do not cover that portion with any adhesives or coating.

2.9 Flux

If you use a halogen type (Chlorine type, Bromine type, etc.) high-activity flux, please use it after confirmation in advance, as it may have an impact on performance and reliability of this product due to the residue of the flux.

3. Precautions for using capacitors

3.1 Environmental conditions

Capacitors should not be stored or used in the following environments.

- (1) Exposure to temperatures above the upper category or below the lower category temperature of the capacitor.
- (2) Direct contact with water, salt water, or oil.
- (3) High humidity conditions where water could condense on the capacitor.
- (4) Exposure to toxic gases such as hydrogen sulfide, sulfuric acid, nitric acid, chlorine, chlorine compound, bromine, bromine compound or ammonia.
- (5) Exposure to ozone, radiation, or ultraviolet rays.
- (6) Vibration and shock conditions exceeding specified requirements.

Even within the specified requirements, a large vibration acceleration may be applied due to resonance, so be sure to evaluate and confirm with the actual product.

3.2 Electrical precautions

- (1) Avoid touching the terminals of a capacitor as a possible electric shock could result. The exposed aluminum case is not insulated and could also cause electric shock if touched.
- (2) Avoid short circuiting the area between the capacitor terminals with conductive materials including liquids such as acids or alkaline solutions.
- (3) A low-molecular-weight-shiroxane which is included in a silicon material shall causes abnormal electrical characteristics.

4. Emergency procedures

- (1) If the pressure relief of the capacitor operates, immediately turn off the equipment and disconnect from the power source.
This will minimize an additional damage caused by the vaporizing electrolyte.
- (2) Avoid contact with the escaping electrolyte gas, which can exceed 100 °C temperatures.
If electrolyte or gas enters the eye, immediately flush the eye with large amounts of water.
If electrolyte or gas is ingested by mouth, gargle with water.
If electrolyte contacts the skin, wash with soap and water.

5. Long term storage

- (1) Leakage current of a capacitor increases with long storage times. The aluminum oxide film deteriorates as a function of temperature and time.
If used without reconditioning, an abnormally high current will be required to restore the oxide film.
This surge current could cause the circuit or the capacitor to fail.
Expiration date is 42 months from outgoing inspection date.
For storage condition, keep room temperature (5 °C to 35 °C) and humidity (45 % to 85 %) where direct sunshine doesn't reach.
- (2) Environmental conditions
Do not store under condition outside the area described in the specification, and also under conditions listed below.
 - (a) Exposure to temperatures above the upper category or below the lower category temperature of the capacitor.
 - (b) Direct contact with water, salt water, or oil.
 - (c) High humidity conditions where water could condense on the capacitor.
 - (d) Exposure to toxic gases such as hydrogen sulfide, sulfuric acid, nitric acid, chlorine, Chlorine compound, Bromine, Bromine compound or ammonia.
 - (e) Exposure to ozone, radiation, or ultraviolet rays.
 - (f) Vibration and shock conditions exceeding specified requirements.

6. Capacitor disposal

When disposing capacitors, use one of the following methods.

- (1) Incinerate after crushing the capacitor or puncturing the can wall (to prevent explosion due to internal pressure rise).
- (2) Dispose as solid waste.

NOTE : Local laws may have specific disposal requirements which must be followed.

The precautions in using aluminum electrolytic capacitors follow the "Safety application guide for the use in fixed aluminum electrolytic capacitors for electronic equipment", RCR-2367D issued by JEITA in October 2017.
Please refer to the above application guide for details.

■ AEC-Q200 compliant

The products are tested based on all or part of the test conditions and methods defined in AEC-Q200. Please consult with Panasonic for the details of the product specification and specific evaluation test results, etc., and please review and approve Panasonic's product specification before ordering.

* Intellectual property right

We, Panasonic Group are providing the product and service that customers can use without anxiety, and are working positively on the protection of our products under intellectual property rights.

Representative patents relating to Conductive Polymer Hybrid Aluminum Electrolytic Capacitors are as follows:

US Patent	No.7497879, No.7621970, No.9208954
JP Patent	No.5360250
EP Patent	No.1808875

Mouser Electronics

Authorized Distributor

Click to View Pricing, Inventory, Delivery & Lifecycle Information:

Panasonic:

[EEH-ZA1E101XP](#) [EEH-ZA1E221P](#) [EEH-ZA1E330R](#) [EEH-ZA1E331P](#) [EEH-ZA1E560P](#) [EEH-ZA1H100R](#) [EEH-ZA1H101P](#) [EEH-ZA1H220P](#) [EEH-ZA1H330XP](#) [EEH-ZA1H680P](#) [EEH-ZA1J100P](#) [EEH-ZA1J220XP](#) [EEH-ZA1J330P](#) [EEH-ZA1J560P](#) [EEH-ZA1V151P](#) [EEH-ZA1V220R](#) [EEH-ZA1V270P](#) [EEH-ZA1V271P](#) [EEH-ZA1V470P](#) [EEH-ZA1V680XP](#) [EEH-ZA1K220P](#) [EEH-ZA1K330P](#) [EEH-ZA1J560V](#) [EEH-ZA1E331V](#) [EEH-ZA1V151V](#) [EEH-ZA1E221V](#) [EEH-ZA1H680V](#) [EEH-ZA1H101V](#) [EEH-ZA1K330V](#) [EEH-ZA1J330V](#) [EEH-ZA1K220V](#) [EEH-ZA1V271V](#) [EEH-ZA1V470V](#) [EEH-ZA1V680XV](#) [EEH-ZA1H330XV](#) [EEH-ZA1E560V](#) [EEH-ZA1J220XV](#) [EEH-ZA1V270V](#) [EEH-ZA1H220V](#) [EEH-ZA1J100V](#) [EEH-ZA1E101XV](#) [EEH-ZA1V221V](#) [EEH-ZA1V330P](#) [EEH-ZA1V330V](#) [EEH-ZA1E151P](#) [EEH-ZA1E151V](#) [EEH-ZA1E220R](#) [EEH-ZA1V100R](#) [EEH-ZA1V101P](#) [EEH-ZA1V101V](#) [EEH-ZA1V221P](#) [EEH-ZA1J470P](#) [EEH-ZA1J470V](#) [EEH-ZA1J680P](#) [EEH-ZA1J680V](#) [EEH-ZA1J820P](#) [EEH-ZA1J820V](#) [EEH-ZA1E470P](#) [EEH-ZA1E470V](#) [EEH-ZA1E680XP](#) [EEH-ZA1E680XV](#) [EEH-ZA1H470P](#) [EEH-ZA1H470V](#)



Компания «ЭлектроПласт» предлагает заключение долгосрочных отношений при поставках импортных электронных компонентов на взаимовыгодных условиях!

Наши преимущества:

- Оперативные поставки широкого спектра электронных компонентов отечественного и импортного производства напрямую от производителей и с крупнейших мировых складов;
- Поставка более 17-ти миллионов наименований электронных компонентов;
- Поставка сложных, дефицитных, либо снятых с производства позиций;
- Оперативные сроки поставки под заказ (от 5 рабочих дней);
- Экспресс доставка в любую точку России;
- Техническая поддержка проекта, помощь в подборе аналогов, поставка прототипов;
- Система менеджмента качества сертифицирована по Международному стандарту ISO 9001;
- Лицензия ФСБ на осуществление работ с использованием сведений, составляющих государственную тайну;
- Поставка специализированных компонентов (Xilinx, Altera, Analog Devices, Intersil, Interpoint, Microsemi, Aeroflex, Peregrine, Syfer, Eurofarad, Texas Instrument, Miteq, Cobham, E2V, MA-COM, Hittite, Mini-Circuits, General Dynamics и др.);

Помимо этого, одним из направлений компании «ЭлектроПласт» является направление «Источники питания». Мы предлагаем Вам помощь Конструкторского отдела:

- Подбор оптимального решения, техническое обоснование при выборе компонента;
- Подбор аналогов;
- Консультации по применению компонента;
- Поставка образцов и прототипов;
- Техническая поддержка проекта;
- Защита от снятия компонента с производства.



Как с нами связаться

Телефон: 8 (812) 309 58 32 (многоканальный)

Факс: 8 (812) 320-02-42

Электронная почта: org@eplast1.ru

Адрес: 198099, г. Санкт-Петербург, ул. Калинина, дом 2, корпус 4, литера А.