

## 50 mA, 100 mA and 150 mA CMOS LDOs with Shutdown and ERROR Output

### Features

- Low Ground Current for Longer Battery Life
- Low Dropout Voltage
- Choice of 50 mA (TC1054), 100 mA (TC1055) and 150 mA (TC1186) Output
- High Output Voltage Accuracy
- Standard or Custom Output Voltages:
  - 1.8V, 2.5V, 2.6V, 2.7V, 2.8V, 2.85V, 3.0V, 3.3V, 3.6V, 4.0V, 5.0V
- Power-Saving Shutdown Mode
- **ERROR** Output Can Be Used as a Low-Battery Detector or Microcontroller-Reset Generator
- Overcurrent and Overtemperature Protection
- 5-Pin SOT-23 Package
- Pin-Compatible Upgrades for Bipolar Regulators

### Applications

- Battery Operated Systems
- Portable Computers
- Medical Instruments
- Instrumentation
- Cellular/GSM/PHS Phones
- Linear Post-Regulators for SMPS
- Pagers

### Typical Application

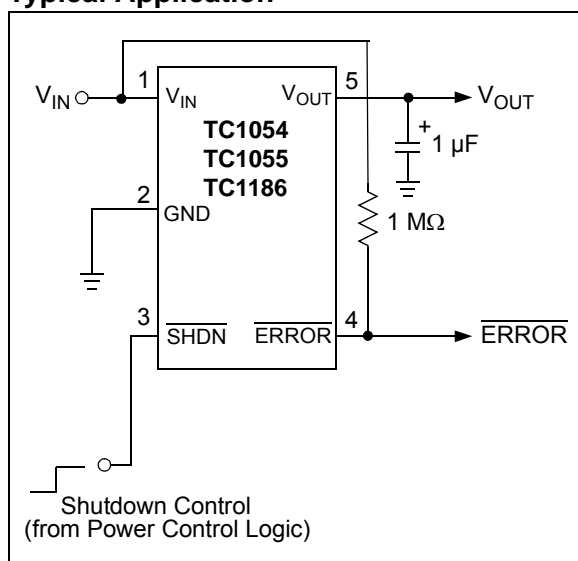

### General Description

The TC1054, TC1055 and TC1186 are high accuracy (typically  $\pm 0.5\%$ ) CMOS upgrades for older (bipolar) low dropout regulators. Designed specifically for battery-operated systems, the devices' CMOS construction minimizes ground current, extending battery life. Total supply current is typically  $50 \mu\text{A}$  at full load (20 to 60 times lower than in bipolar regulators).

The devices' key features include low noise operation, low dropout voltage – typically  $85 \text{ mV}$  (TC1054),  $180 \text{ mV}$  (TC1055) and  $270 \text{ mV}$  (TC1186) at full load — and fast response to step changes in load. An error output (**ERROR**) is asserted when the devices are out-of-regulation (due to a low input voltage or excessive output current). **ERROR** can be used as a low battery warning or as a processor **RESET** signal (with the addition of an external RC network). Supply current is reduced to  $0.5 \mu\text{A}$  (maximum), with both  $V_{\text{OUT}}$  and **ERROR** disabled when the shutdown input is low. The devices incorporate both overtemperature and over-current protection.

The TC1054, TC1055 and TC1186 are stable with an output capacitor of only  $1 \mu\text{F}$ , and have a maximum output current of 50 mA, 100 mA and 150 mA, respectively. For higher output current regulators, please refer to the TC1173 ( $I_{\text{OUT}} = 300 \text{ mA}$ ) data sheet (DS21632).

### Package Type

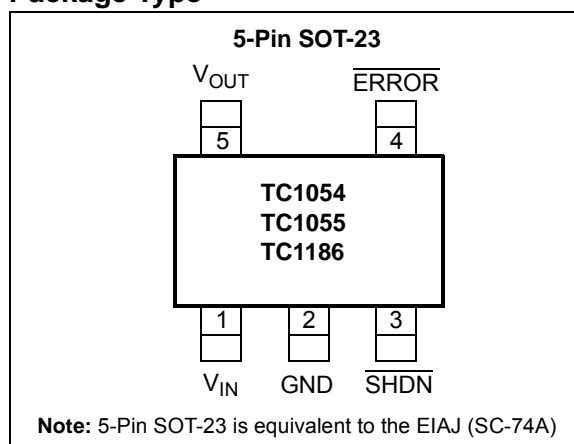

# TC1054/TC1055/TC1186

## 1.0 ELECTRICAL CHARACTERISTICS

### Absolute Maximum Ratings †

Input Voltage .....	6.75V
Output Voltage .....	(-0.3V) to (V <sub>IN</sub> + 0.3V)
Power Dissipation .....	Internally Limited ( <b>Note 6</b> )
Maximum Voltage on Any Pin .....	V <sub>IN</sub> + 0.3V to -0.3V
Operating Junction Temperature Range ..	-40°C <T <sub>J</sub> < +125°C
Storage Temperature.....	-65°C to +150°C

† **Notice:** Stresses above those listed under "Absolute Maximum Ratings" may cause permanent damage to the device. These are stress ratings only and functional operation of the device at these or any other conditions above those indicated in the operation sections of the specifications is not implied. Exposure to Absolute Maximum Rating conditions for extended periods may affect device reliability.

### DC CHARACTERISTICS

**Electrical Specifications:** Unless otherwise noted, V<sub>IN</sub> = V<sub>OUT</sub> + 1V, I<sub>L</sub> = 100 μA, C<sub>L</sub> = 3.3 μF, SHDN > V<sub>IH</sub>, T<sub>A</sub> = +25°C. **Boldface** type specifications apply for junction temperatures of -40°C to +125°C.

Parameters	Sym	Min	Typ	Max	Units	Conditions
Input Operating Voltage	V <sub>IN</sub>	<b>2.7</b>	—	<b>6.50</b>	V	<a href="#">Note 8</a>
Maximum Output Current	I <sub>OUTMAX</sub>	<b>50</b>	—	—	mA	<b>TC1054</b>
		<b>100</b>	—	—		<b>TC1055</b>
		<b>150</b>	—	—		<b>TC1186</b>
Output Voltage	V <sub>OUT</sub>	<b>V<sub>R</sub> - 2.5%</b>	V <sub>R</sub> ±0.5%	<b>V<sub>R</sub> + 2.5%</b>	V	<a href="#">Note 1</a>
V <sub>OUT</sub> Temperature Coefficient	TCV <sub>OUT</sub>	—	20	—	ppm/°C	<a href="#">Note 2</a>
		—	<b>40</b>	—		
Line Regulation	ΔV <sub>OUT</sub> /ΔV <sub>IN</sub>	—	0.05	<b>0.35</b>	%	(V <sub>R</sub> + 1V) ≤ V <sub>IN</sub> ≤ 6V
<b>Load Regulation</b>						
<b>TC1054; TC1055</b>	ΔV <sub>OUT</sub> /V <sub>OUT</sub>	—	0.5	<b>2</b>	%	<a href="#">(Note 3)</a> I <sub>L</sub> = 0.1 mA to I <sub>OUTMAX</sub>
<b>TC1186</b>		—	0.5	<b>3</b>		

**Note 1:** V<sub>R</sub> is the regulator output voltage setting. For example: V<sub>R</sub> = 1.8V, 2.5V, 2.7V, 2.85V, 3.0V, 3.3V, 3.6V, 4.0V, 5.0V.

**2:** 
$$TC V_{OUT} = \frac{(V_{OUTMAX} - V_{OUTMIN}) \times 10^6}{V_{OUT} \times \Delta T}$$

- 3:** Regulation is measured at a constant junction temperature using low-duty-cycle pulse testing. Load regulation is tested over a load range from 0.1 mA to the maximum specified output current. Changes in output voltage due to heating effects are covered by the thermal regulation specification.
- 4:** Dropout voltage is defined as the input to output differential at which the output voltage drops 2% below its nominal value.
- 5:** Thermal Regulation is defined as the change in output voltage at a time T after a change in power dissipation is applied, excluding load or line regulation effects. Specifications are for a current pulse equal to I<sub>LMAX</sub> at V<sub>IN</sub> = 6V for T = 10 ms.
- 6:** The maximum allowable power dissipation is a function of ambient temperature, the maximum allowable junction temperature and the thermal resistance from junction-to-air (i.e., T<sub>A</sub>, T<sub>J</sub>, θ<sub>JA</sub>). Exceeding the maximum allowable power dissipation causes the device to initiate thermal shutdown. See **Section 5.0 "Thermal Considerations"** for more details.
- 7:** Hysteresis voltage is referenced by V<sub>R</sub>.
- 8:** The minimum V<sub>IN</sub> has to justify the conditions: V<sub>IN</sub> ≥ V<sub>R</sub> + V<sub>DROPOUT</sub> and V<sub>IN</sub> ≥ 2.7V for I<sub>L</sub> = 0.1 mA to I<sub>OUTMAX</sub>.
- 9:** Apply for junction temperatures of -40°C to +85°C.

# TC1054/TC1055/TC1186

## DC CHARACTERISTICS (CONTINUED)

**Electrical Specifications:** Unless otherwise noted,  $V_{IN} = V_{OUT} + 1V$ ,  $I_L = 100 \mu A$ ,  $C_L = 3.3 \mu F$ ,  $\overline{SHDN} > V_{IH}$ ,  $T_A = +25^\circ C$ . **Boldface** type specifications apply for junction temperatures of  $-40^\circ C$  to  $+125^\circ C$ .

Parameters	Sym	Min	Typ	Max	Units	Conditions
Dropout Voltage	$V_{IN} - V_{OUT}$	—	2	—	mV	$I_L = 100 \mu A$
		—	65	—		$I_L = 20 mA$
		—	85	<b>120</b>		$I_L = 50 mA$
		—	180	<b>250</b>		$I_L = 100 mA$
		—	270	<b>400</b>		$I_L = 150 mA$ (Note 4)
TC1055; TC1186						
TC1186						
Supply Current	$I_{IN}$	—	50	<b>80</b>	$\mu A$	$\overline{SHDN} = V_{IH}$ , $I_L = 0 \mu A$ (Note 9)
Shutdown Supply Current	$I_{INSD}$	—	0.05	0.5	$\mu A$	$\overline{SHDN} = 0V$
Power Supply Rejection Ratio	PSRR	—	64	—	dB	$f \leq 1 kHz$
Output Short Circuit Current	$I_{OUTSC}$	—	300	450	mA	$V_{OUT} = 0V$
Thermal Regulation	$\Delta V_{OUT}/\Delta P_D$	—	0.04	—	V/W	Notes 5, 6
Thermal Shutdown Die Temperature	$T_{SD}$	—	160	—	$^\circ C$	
Thermal Shutdown Hysteresis	$\Delta T_{SD}$	—	10	—	$^\circ C$	
Output Noise	eN	—	260	—	nV/ $\sqrt{Hz}$	$I_L = I_{OUTMAX}$
<b>SHDN Input</b>						
SHDN Input High Threshold	$V_{IH}$	45	—	—	% $V_{IN}$	$V_{IN} = 2.5V$ to $6.5V$
SHDN Input Low Threshold	$V_{IL}$	—	—	15	% $V_{IN}$	$V_{IN} = 2.5V$ to $6.5V$
<b>ERROR Output</b>						
Minimum $V_{IN}$ Operating Voltage	$V_{INMIN}$	1.0	—	—	V	
Output Logic Low Voltage	$V_{OL}$	—	—	400	mV	1 mA Flows to $\overline{ERROR}$
ERROR Threshold Voltage	$V_{TH}$	—	$0.95 \times V_R$	—	V	See Figure 4-2
ERROR Positive Hysteresis	$V_{HYS}$	—	50	—	mV	Note 7
$V_{OUT}$ to $\overline{ERROR}$ Delay	$t_{DELAY}$	—	2.5	—	ms	$V_{OUT}$ falling from $V_R$ to $V_R - 10\%$

**Note 1:**  $V_R$  is the regulator output voltage setting. For example:  $V_R = 1.8V, 2.5V, 2.7V, 2.85V, 3.0V, 3.3V, 3.6V, 4.0V, 5.0V$ .

**2:**  $TC V_{OUT} = \frac{(V_{OUTMAX} - V_{OUTMIN}) \times 10^6}{V_{OUT} \times \Delta T}$

- Regulation is measured at a constant junction temperature using low-duty-cycle pulse testing. Load regulation is tested over a load range from 0.1 mA to the maximum specified output current. Changes in output voltage due to heating effects are covered by the thermal regulation specification.
- Dropout voltage is defined as the input to output differential at which the output voltage drops 2% below its nominal value.
- Thermal Regulation is defined as the change in output voltage at a time T after a change in power dissipation is applied, excluding load or line regulation effects. Specifications are for a current pulse equal to  $I_{LMAX}$  at  $V_{IN} = 6V$  for  $T = 10 ms$ .
- The maximum allowable power dissipation is a function of ambient temperature, the maximum allowable junction temperature and the thermal resistance from junction-to-air (i.e.,  $T_A, T_J, \theta_{JA}$ ). Exceeding the maximum allowable power dissipation causes the device to initiate thermal shutdown. See Section 5.0 "Thermal Considerations" for more details.
- Hysteresis voltage is referenced by  $V_R$ .
- The minimum  $V_{IN}$  has to justify the conditions:  $V_{IN} \geq V_R + V_{DROPOUT}$  and  $V_{IN} \geq 2.7V$  for  $I_L = 0.1 mA$  to  $I_{OUTMAX}$ .
- Apply for junction temperatures of  $-40^\circ C$  to  $+85^\circ C$ .

# TC1054/TC1055/TC1186

## 2.0 TYPICAL PERFORMANCE CURVES

**Note:** The graphs and tables provided following this note are a statistical summary based on a limited number of samples and are provided for informational purposes only. The performance characteristics listed herein are not tested or guaranteed. In some graphs or tables, the data presented may be outside the specified operating range (e.g., outside specified power supply range) and therefore outside the warranted range.

**Note:** Unless otherwise indicated,  $V_{IN} = V_{OUT} + 1V$ ,  $I_L = 100 \mu A$ ,  $C_L = 3.3 \mu F$ ,  $\overline{SHDN} > V_{IH}$ ,  $T_A = +25^\circ C$ .

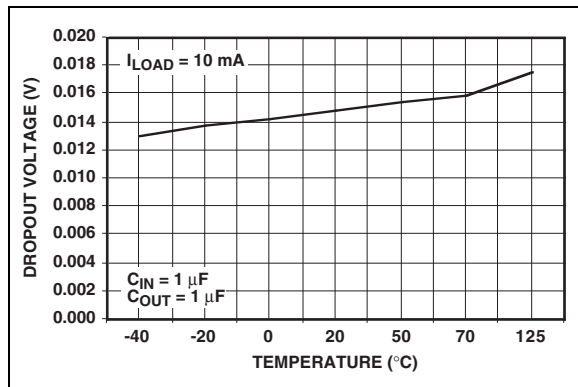

**FIGURE 2-1:** Dropout Voltage vs. Temperature ( $I_{LOAD} = 10 \text{ mA}$ ).

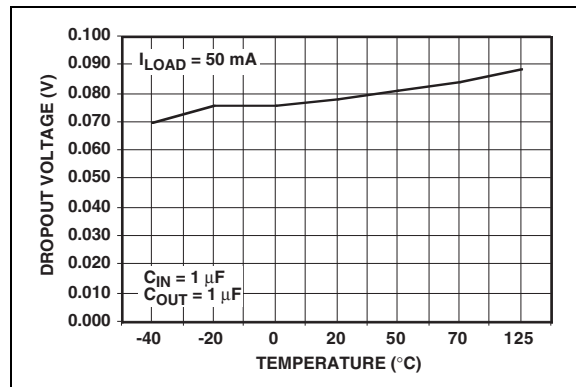

**FIGURE 2-4:** Dropout Voltage vs. Temperature ( $I_{LOAD} = 50 \text{ mA}$ ).



**FIGURE 2-2:** Dropout Voltage vs. Temperature ( $I_{LOAD} = 100 \text{ mA}$ ).

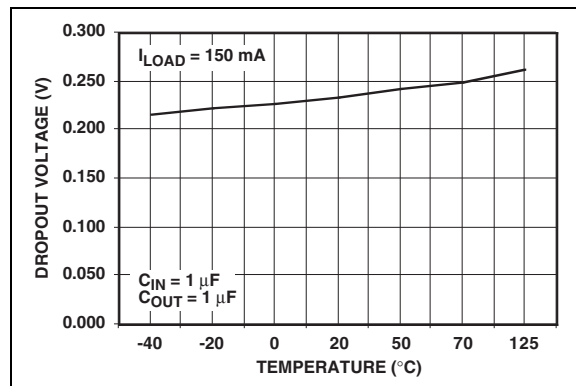

**FIGURE 2-5:** Dropout Voltage vs. Temperature ( $I_{LOAD} = 150 \text{ mA}$ ).

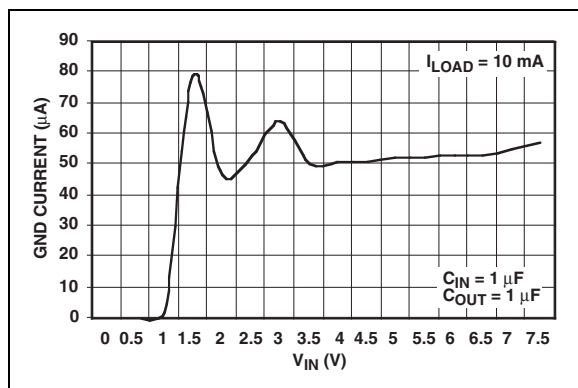

**FIGURE 2-3:** Ground Current vs.  $V_{IN}$  ( $I_{LOAD} = 10 \text{ mA}$ ).

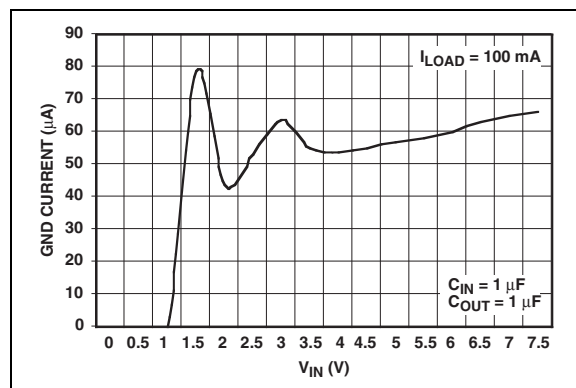

**FIGURE 2-6:** Ground Current vs.  $V_{IN}$  ( $I_{LOAD} = 100 \text{ mA}$ ).

# TC1054/TC1055/TC1186

**Note:** Unless otherwise indicated,  $V_{IN} = V_{OUT} + 1V$ ,  $I_L = 100 \mu A$ ,  $C_L = 3.3 \mu F$ ,  $\overline{SHDN} > V_{IH}$ ,  $T_A = +25^\circ C$ .

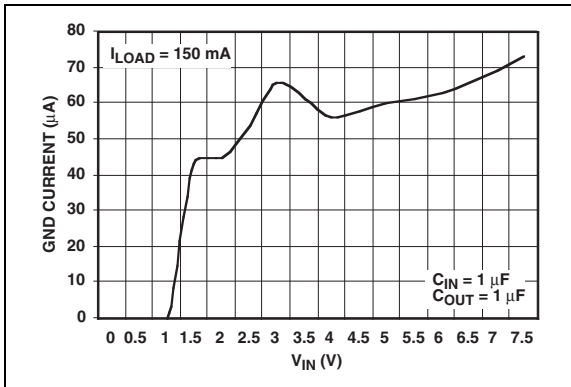

**FIGURE 2-7:** Ground Current vs.  $V_{IN}$  ( $I_{LOAD} = 150 \text{ mA}$ ).

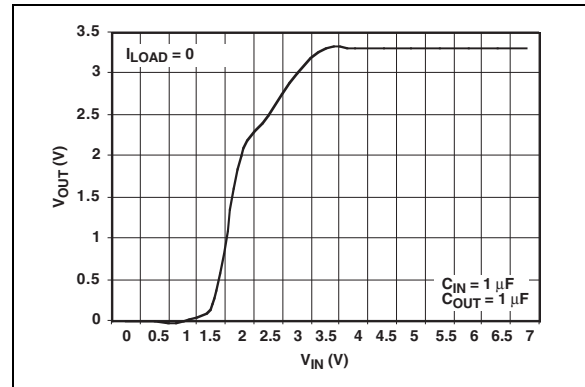

**FIGURE 2-10:**  $V_{OUT}$  vs.  $V_{IN}$  ( $I_{LOAD} = 0 \text{ mA}$ ).

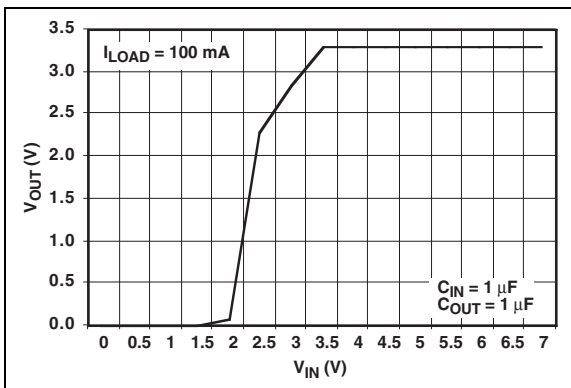

**FIGURE 2-8:**  $V_{OUT}$  vs.  $V_{IN}$  ( $I_{LOAD} = 100 \text{ mA}$ ).

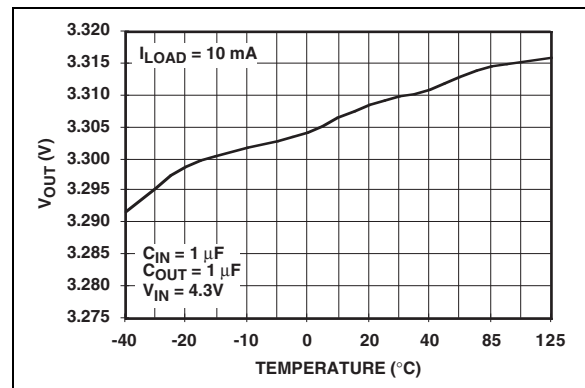

**FIGURE 2-11:** Output Voltage (3.3V) vs. Temperature ( $I_{LOAD} = 10 \text{ mA}$ ).

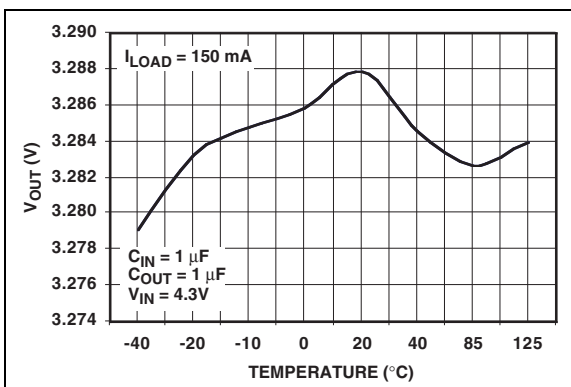

**FIGURE 2-9:**  $V_{OUT}$  vs.  $V_{IN}$  ( $I_{LOAD} = 150 \text{ mA}$ ).

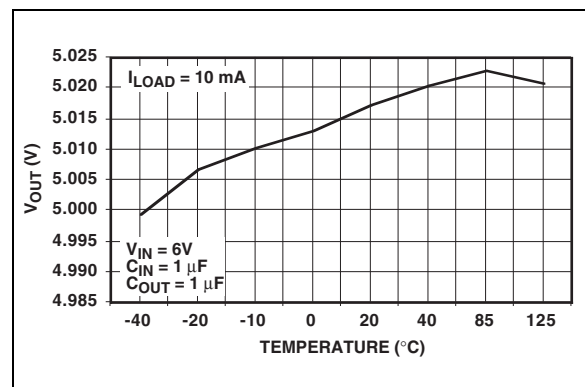

**FIGURE 2-12:** Output Voltage (5V) vs. Temperature ( $I_{LOAD} = 10 \text{ mA}$ ).

# TC1054/TC1055/TC1186

**Note:** Unless otherwise indicated,  $V_{IN} = V_{OUT} + 1V$ ,  $I_L = 100 \mu A$ ,  $C_L = 3.3 \mu F$ ,  $\overline{SHDN} > V_{IH}$ ,  $T_A = +25^\circ C$ .

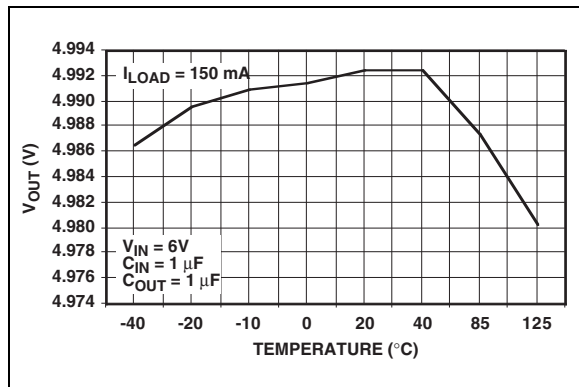

**FIGURE 2-13:** Output Voltage (5V) vs. Temperature ( $I_{LOAD} = 10 \text{ mA}$ ).

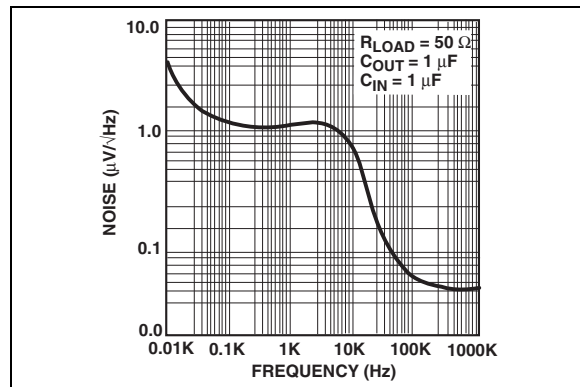

**FIGURE 2-16:** Output Noise vs. Frequency.

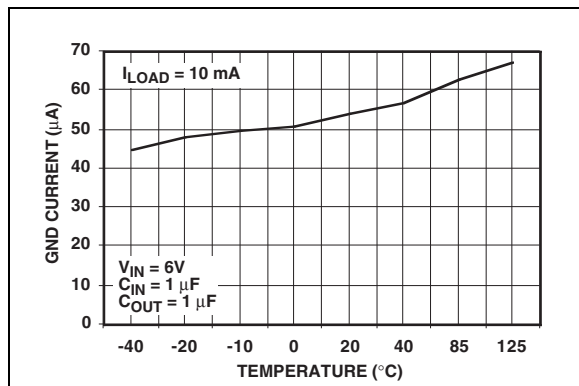

**FIGURE 2-14:** GND Current vs. Temperature ( $I_{LOAD} = 10 \text{ mA}$ ).

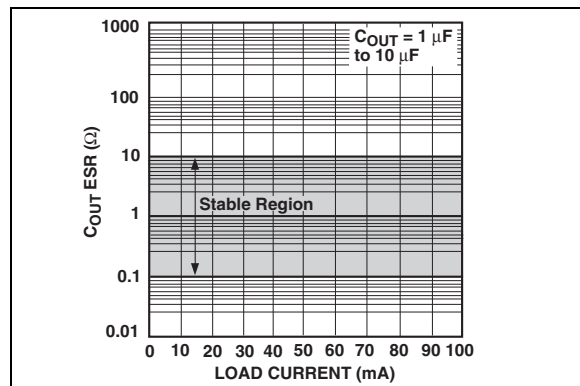

**FIGURE 2-17:** Stability Region vs. Load Current.

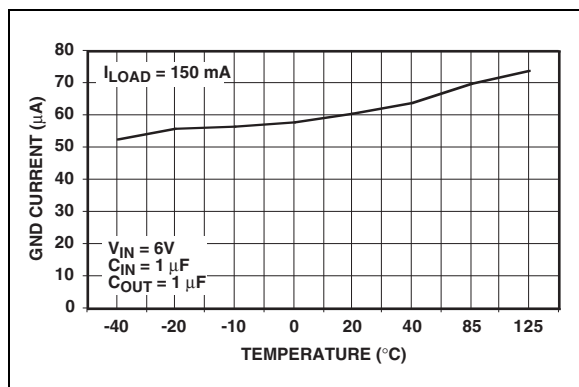

**FIGURE 2-15:** GND Current vs. Temperature ( $I_{LOAD} = 150 \text{ mA}$ ).

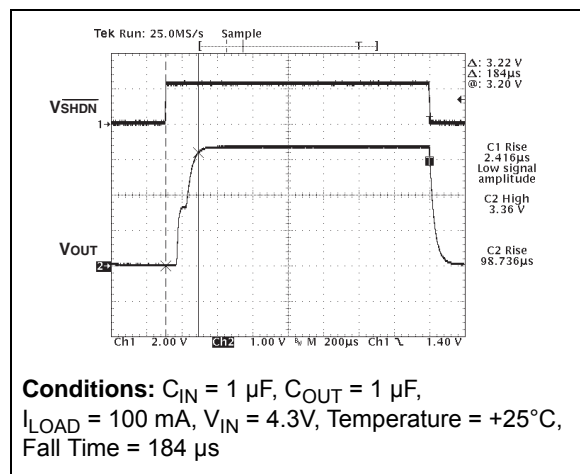

**FIGURE 2-18:** Measure Rise Time of 3.3V LDO.

# TC1054/TC1055/TC1186

**Note:** Unless otherwise indicated,  $V_{IN} = V_{OUT} + 1V$ ,  $I_L = 100 \mu A$ ,  $C_L = 3.3 \mu F$ ,  $\overline{SHDN} > V_{IH}$ ,  $T_A = +25^\circ C$ .

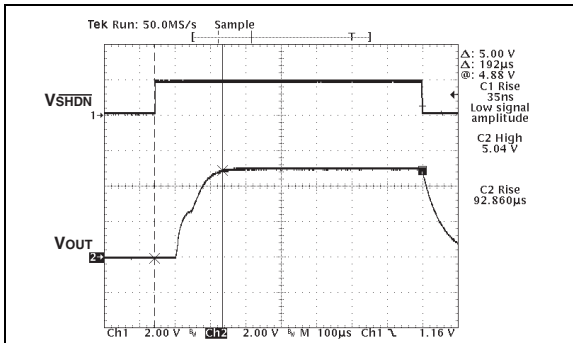

**Conditions:**  $C_{IN} = 1 \mu F$ ,  $C_{OUT} = 1 \mu F$ ,  
 $I_{LOAD} = 100 \text{ mA}$ ,  $V_{IN} = 6V$ , Temperature =  $+25^\circ C$ ,  
 Fall Time =  $192 \mu s$

**FIGURE 2-19:** Measure Rise Time of 5.0V LDO.

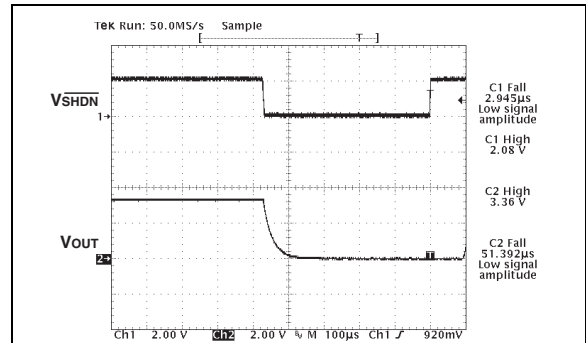

**Conditions:**  $C_{IN} = 1 \mu F$ ,  $C_{OUT} = 1 \mu F$ ,  
 $I_{LOAD} = 100 \text{ mA}$ ,  $V_{IN} = 4.3V$ , Temperature =  $+25^\circ C$ ,  
 Fall Time =  $52 \mu s$

**FIGURE 2-21:** Measure Fall Time of 3.3V LDO.

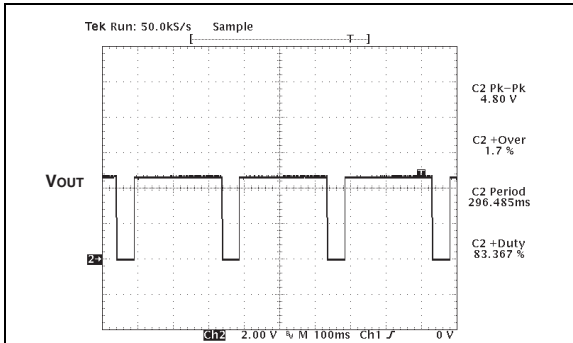

**Conditions:**  $V_{IN} = 6V$ ,  $C_{IN} = 0 \mu F$ ,  $C_{OUT} = 1 \mu F$

$I_{LOAD}$  was increased until temperature of die reached about  $+160^\circ C$ , at which time integrated thermal protection circuitry shuts the regulator off when die temperature exceeds approximately  $+160^\circ C$ . The regulator remains off until die temperature drops to approximately  $+150^\circ C$ .

**FIGURE 2-20:** Thermal Shutdown Response of 5.0V LDO.

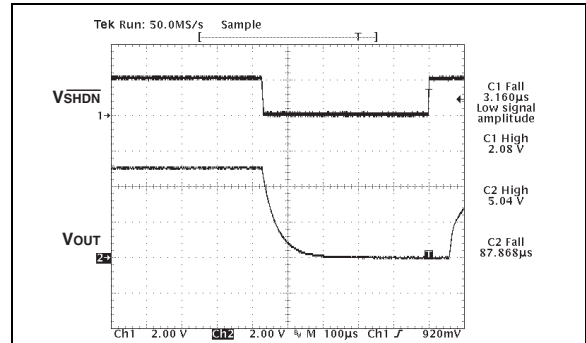

**Conditions:**  $C_{IN} = 1 \mu F$ ,  $C_{OUT} = 1 \mu F$ ,  
 $I_{LOAD} = 100 \text{ mA}$ ,  $V_{IN} = 6V$ , Temperature =  $+25^\circ C$ ,  
 Fall Time =  $88 \mu s$

**FIGURE 2-22:** Measure Fall Time of 5.0V LDO.

# TC1054/TC1055/TC1186

## 3.0 PIN DESCRIPTIONS

The descriptions of the pins are listed in [Table 3-1](#).

**TABLE 3-1: PIN FUNCTION TABLE**

Pin No. SOT-23	Symbol	Description
1	$V_{IN}$	Unregulated supply input
2	GND	Ground terminal
3	$\overline{\text{SHDN}}$	Shutdown control input
4	$\overline{\text{ERROR}}$	Out-of-Regulation Flag (Open-drain output)
5	$V_{OUT}$	Regulated voltage output

### 3.1 Unregulated Supply Input ( $V_{IN}$ )

Connect unregulated input supply to the  $V_{IN}$  pin. If there is a large distance between the input supply and the LDO regulator, some input capacitance is necessary for proper operation. A 1  $\mu\text{F}$  capacitor connected from  $V_{IN}$  to ground is recommended for most applications.

### 3.2 Ground Terminal (GND)

Connect the unregulated input supply ground return to GND. Also connect the negative side of the 1  $\mu\text{F}$  typical input decoupling capacitor close to GND and the negative side of the output capacitor  $C_{OUT}$  to GND.

### 3.3 Shutdown Control Input ( $\overline{\text{SHDN}}$ )

The regulator is fully enabled when a logic-high is applied to  $\overline{\text{SHDN}}$ . The regulator enters shutdown when a logic-low is applied to  $\overline{\text{SHDN}}$ . During shutdown, output voltage falls to zero,  $\overline{\text{ERROR}}$  is open-circuited and supply current is reduced to 0.5  $\mu\text{A}$  (maximum).

### 3.4 Out Of Regulation Flag ( $\overline{\text{ERROR}}$ )

$\overline{\text{ERROR}}$  goes low when  $V_{OUT}$  is out-of-tolerance by approximately -5%.

### 3.5 Regulated Voltage Output ( $V_{OUT}$ )

Connect the output load to  $V_{OUT}$  of the LDO. Also connect the positive side of the LDO output capacitor as close as possible to the  $V_{OUT}$  pin.



## 4.0 DETAILED DESCRIPTION

The TC1054, TC1055 and TC1186 are precision fixed output voltage regulators (If an adjustable version is desired, please see the TC1070/TC1071/TC1187 data sheet (DS21353)). Unlike bipolar regulators, the TC1054, TC1055 and TC1186 supply current does not increase with load current.

Figure 4-1 shows a typical application circuit, where the regulator is enabled any time the shutdown input (SHDN) is at or above  $V_{IH}$ , and shutdown (disabled) when SHDN is at or below  $V_{IL}$ . SHDN may be controlled by a CMOS logic gate or I/O port of a microcontroller. If the SHDN input is not required, it should be connected directly to the input supply. While in Shutdown, supply current decreases to 0.05  $\mu$ A (typical),  $V_{OUT}$  falls to zero volts, and  $\overline{\text{ERROR}}$  is open-circuited.

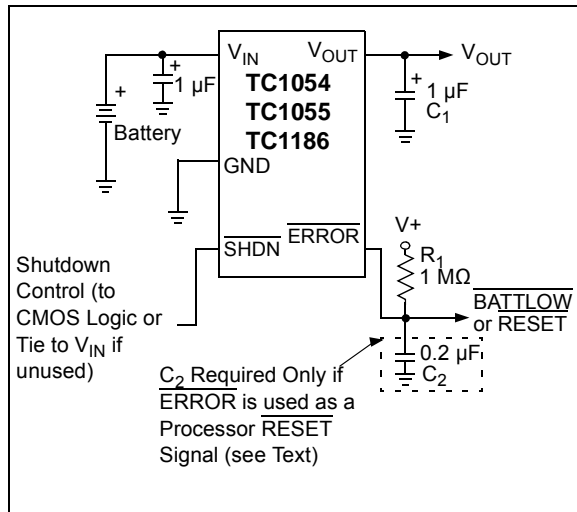

FIGURE 4-1: Typical Application Circuit.

## 4.1 $\overline{\text{ERROR}}$ Open-Drain Output

$\overline{\text{ERROR}}$  is driven low whenever  $V_{OUT}$  falls out of regulation by more than -5% (typical). This condition may be caused by low input voltage, output current limiting or thermal limiting. The  $\overline{\text{ERROR}}$  threshold is 5% below rated  $V_{OUT}$ , regardless of the programmed output voltage value (e.g.  $\overline{\text{ERROR}} = V_{OL}$  at 4.75V (typical) for a 5.0V regulator and 2.85V (typical) for a 3.0V regulator).  $\overline{\text{ERROR}}$  output operation is shown in Figure 4-2.

Note that  $\overline{\text{ERROR}}$  is active when  $V_{OUT}$  falls to  $V_{TH}$  and inactive when  $V_{OUT}$  rises above  $V_{TH}$  by  $V_{HYS}$ .

As shown in Figure 4-1,  $\overline{\text{ERROR}}$  can be used either as a battery low flag or as a processor  $\overline{\text{RESET}}$  signal (with the addition of timing capacitor  $C_2$ ).  $R_1 \times C_2$  should be chosen to maintain  $\overline{\text{ERROR}}$  below  $V_{IH}$  of the processor  $\overline{\text{RESET}}$  input for at least 200 ms to allow time for the system to stabilize. Pull-up resistor  $R_1$  can be tied to  $V_{OUT}$ ,  $V_{IN}$  or any other voltage less than  $(V_{IN} + 0.3V)$ .

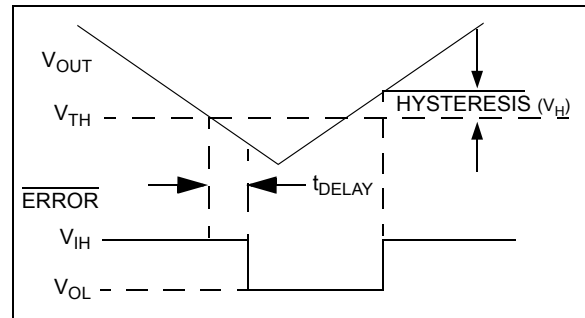

FIGURE 4-2:  $\overline{\text{ERROR}}$  Output Operation.

## 4.2 Output Capacitor

A 1  $\mu$ F (minimum) capacitor from  $V_{OUT}$  to ground is recommended. The output capacitor should have an effective series resistance greater than 0.1 $\Omega$  and less than 10.0 $\Omega$ , with a resonant frequency above 1 MHz. A 1  $\mu$ F capacitor should be connected from  $V_{IN}$  to GND if there is more than 10 inches of wire between the regulator and the AC filter capacitor, or if a battery is used as the power source. Aluminum electrolytic or tantalum capacitor types can be used (since many aluminum electrolytic capacitors freeze at approximately -30°C, solid tantalums are recommended for applications operating below -25°C). When operating from sources other than batteries, supply-noise rejection and transient response can be improved by increasing the value of the input and output capacitors and employing passive filtering techniques.

# TC1054/TC1055/TC1186

## 5.0 THERMAL CONSIDERATIONS

### 5.1 Thermal Shutdown

Integrated thermal protection circuitry shuts the regulator off when die temperature exceeds +160°C. The regulator remains off until the die temperature drops to approximately +150°C.

### 5.2 Power Dissipation

The amount of power the regulator dissipates is primarily a function of input voltage, output voltage and output current. The following equation is used to calculate worst-case actual power dissipation:

#### EQUATION 5-1:

$$P_D \approx (V_{INMAX} - V_{OUTMIN})I_{LOADMAX}$$

Where:

$P_D$  = Worst-case actual power dissipation

$V_{INmax}$  = Maximum voltage on  $V_{IN}$

$V_{OUTmin}$  = Minimum regulator output voltage

$I_{LOADmax}$  = Maximum output (load) current

The maximum allowable power dissipation (Equation 5-2) is a function of the maximum ambient temperature ( $T_{AMAX}$ ), the maximum allowable die temperature ( $T_{JMAX}$ ) and the thermal resistance from junction-to-air ( $\theta_{JA}$ ). The 5-Pin SOT-23 package has a  $\theta_{JA}$  of approximately 220°C/Watt.

#### EQUATION 5-2:

$$P_{DMAX} = \frac{(T_{JMAX} - T_{AMAX})}{\theta_{JA}}$$

Where all terms are previously defined.

Equation 5-1 can be used in conjunction with Equation 5-2 to ensure regulator thermal operation is within limits.

For example:

Given:

$$V_{INMAX} = 3.0V + 5\%$$

$$V_{OUTMIN} = 2.7V - 2.5\%$$

$$I_{LOADMAX} = 40 \text{ mA}$$

$$T_{JMAX} = +125^\circ\text{C}$$

$$T_{AMAX} = +55^\circ\text{C}$$

- Find:
1. Actual power dissipation
  2. Maximum allowable dissipation

Actual power dissipation:

$$\begin{aligned} P_D &\approx (V_{INMAX} - V_{OUTMIN})I_{LOADMAX} \\ &= [(3.0 \times 1.05) - (2.7 \times 0.975)]40 \times 10^{-3} \\ &= 20.7\text{mW} \end{aligned}$$

Maximum allowable power dissipation:

$$\begin{aligned} P_{DMAX} &= \frac{(T_{JMAX} - T_{AMAX})}{\theta_{JA}} \\ &= \frac{(125 - 55)}{220} \\ &= 318\text{mW} \end{aligned}$$

In this example, the TC1054 dissipates a maximum of 20.7 mW; below the allowable limit of 318 mW. In a similar manner, Equation 5-1 and Equation 5-2 can be used to calculate maximum current and/or input voltage limits.

### 5.3 Layout Considerations

The primary path of heat conduction out of the package is via the package leads. Layouts having a ground plane, wide traces at the pads and wide power supply bus lines, combine to lower  $\theta_{JA}$  and increase the maximum allowable power dissipation limit.

## 6.0 PACKAGING INFORMATION

### 6.1 Package Marking Information

5-Lead SOT-23



Example



(V)	TC1054 Code	TC1055 Code	TC1186 Code
1.8	CYNN	DYNN	PYNN
2.5	C1NN	D1NN	P1NN
2.6	CTNN	DTNN	PVNN
2.7	C2NN	D2NN	P2NN
2.8	CZNN	DZNN	PZNN
2.85	C8NN	D8NN	P8NN
3.0	C3NN	D3NN	P3NN
3.3	C4NN	D4NN	P5NN
3.6	C9NN	D9NN	P9NN
4.0	C0NN	D0NN	P0NN
5.0	C6NN	D6NN	P7NN

**Legend:** XX...X Customer-specific information  
 Y Year code (last digit of calendar year)  
 YY Year code (last 2 digits of calendar year)  
 WW Week code (week of January 1 is week '01')  
 NNN Alphanumeric traceability code  
 (e3) Pb-free JEDEC designator for Matte Tin (Sn)  
 \* This package is Pb-free. The Pb-free JEDEC designator (e3) can be found on the outer packaging for this package.

**Note:** In the event the full Microchip part number cannot be marked on one line, it will be carried over to the next line, thus limiting the number of available characters for customer-specific information.

# TC1054/TC1055/TC1186

## 5-Lead Plastic Small Outline Transistor (CT) [SOT-23]

**Note:** For the most current package drawings, please see the Microchip Packaging Specification located at <http://www.microchip.com/packaging>



		Units	MILLIMETERS		
Dimension Limits			MIN	NOM	MAX
Number of Pins	N		5		
Lead Pitch	e		0.95 BSC		
Outside Lead Pitch	e1		1.90 BSC		
Overall Height	A	0.90	–		1.45
Molded Package Thickness	A2	0.89	–		1.30
Standoff	A1	0.00	–		0.15
Overall Width	E	2.20	–		3.20
Molded Package Width	E1	1.30	–		1.80
Overall Length	D	2.70	–		3.10
Foot Length	L	0.10	–		0.60
Footprint	L1	0.35	–		0.80
Foot Angle	$\phi$	0°	–		30°
Lead Thickness	c	0.08	–		0.26
Lead Width	b	0.20	–		0.51

**Notes:**

- Dimensions D and E1 do not include mold flash or protrusions. Mold flash or protrusions shall not exceed 0.127 mm per side.
- Dimensioning and tolerancing per ASME Y14.5M.

BSC: Basic Dimension. Theoretically exact value shown without tolerances.

Microchip Technology Drawing C04-091B

## 5-Lead Plastic Small Outline Transistor (CT) [SOT-23]

**Note:** For the most current package drawings, please see the Microchip Packaging Specification located at <http://www.microchip.com/packaging>

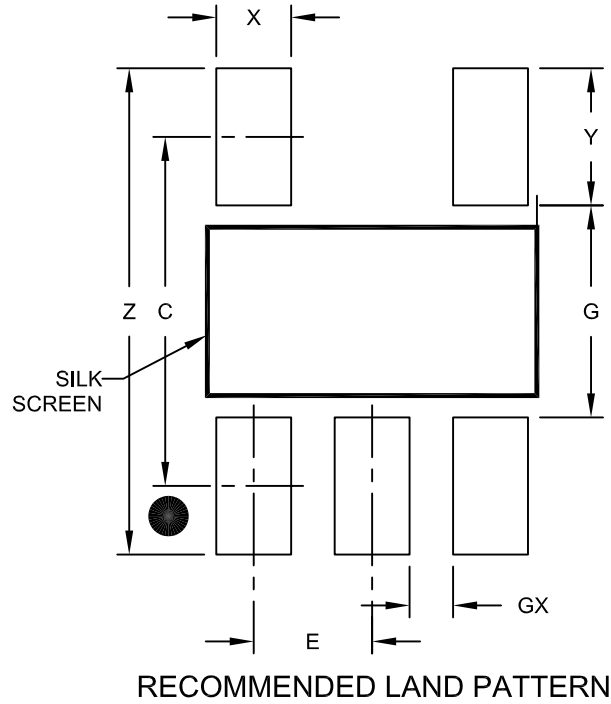

Dimension Limits	Units	MILLIMETERS		
		MIN	NOM	MAX
Contact Pitch	E	0.95 BSC		
Contact Pad Spacing	C		2.80	
Contact Pad Width (X5)	X			0.60
Contact Pad Length (X5)	Y			1.10
Distance Between Pads	G	1.70		
Distance Between Pads	GX	0.35		
Overall Width	Z			3.90

**Notes:**

1. Dimensioning and tolerancing per ASME Y14.5M

BSC: Basic Dimension. Theoretically exact value shown without tolerances.

Microchip Technology Drawing No. C04-2091A

# TC1054/TC1055/TC1186

---

NOTES:

## APPENDIX A: REVISION HISTORY

### Revision E (December 2012)

The following is the list of modifications:

1. Updated the Input Voltage value in [Absolute Maximum Ratings †](#) section.
2. Updated [Section 6.0, Packaging Information](#).
3. Updated [Product Identification System](#).

### Revision D (February 2007)

- Corrected standard output voltages on page 1 and in [Section , Product Identification System](#).
- Added  $T_{DELAY}$  parameter in DC Characteristics table in [Section 1.0, Electrical Characteristics](#).
- Changes to [Figure 4-2](#).
- [Section 6.0, Packaging Information](#): Corrected SOT-23 Packaging Information.

### Revision C (March 2003)

- Undocumented changes.

### Revision B (May 2002)

- Undocumented changes.

### Revision A (March 2002)

- Original Release of this Document.

# TC1054/TC1055/TC1186

---

NOTES:



# TC1054/TC1055/TC1186

## PRODUCT IDENTIFICATION SYSTEM

To order or obtain information, e.g., on pricing or delivery, refer to the factory or the listed sales office.

PART NO.	—	X.X	X	XXXXX	
Device		Output Voltage	Temperature Range	Package	<b>Examples:</b>
<b>Device:</b>					a) TC1054-1.8VCT713: 1.8V LDO Regulator, Various Temp., 5LD SOT-23 Package
					b) TC1054-2.5VCT713: 2.5V LDO Regulator, Various Temp., 5LD SOT-23 Package
					c) TC1054-2.6VCT713: 2.6V LDO Regulator, Various Temp., 5LD SOT-23 Package
					d) TC1054-2.7VCT713: 2.7V LDO Regulator, Various Temp., 5LD SOT-23 Package
					e) TC1054-2.8VCT713: 2.8V LDO Regulator, Various Temp., 5LD SOT-23 Package
					f) TC1054-2.85VCT713: 2.85V LDO Regulator, Various Temp., 5LD SOT-23 Package
					g) TC1054-3.0VCT713: 3.0V LDO Regulator, Various Temp., 5LD SOT-23 Package
					h) TC1054-3.3VCT713: 3.3V LDO Regulator, Various Temp., 5LD SOT-23 Package
					i) TC1054-3.6VCT713: 3.6V LDO Regulator, Various Temp., 5LD SOT-23 Package
					j) TC1054-4.0VCT713: 4.0V LDO Regulator, Various Temp., 5LD SOT-23 Package
					k) TC1054-5.0VCT713: 5.0V LDO Regulator, Various Temp., 5LD SOT-23 Package
<b>Output Voltage *:</b>		1.8 = 1.8V "Standard"			a) TC1055-1.8VCT713: 1.8V LDO Regulator, Various Temp., 5LD SOT-23 Package
		2.5 = 2.5V "Standard"			b) TC1055-2.5VCT713: 2.5V LDO Regulator, Various Temp., 5LD SOT-23 Package
		2.6 = 2.6V "Standard"			c) TC1055-2.6VCT713: 2.6V LDO Regulator, Various Temp., 5LD SOT-23 Package
		2.7 = 2.7V "Standard"			d) TC1055-2.7VCT713: 2.7V LDO Regulator, Various Temp., 5LD SOT-23 Package
		2.8 = 2.8V "Standard"			e) TC1055-2.8VCT713: 2.8V LDO Regulator, Various Temp., 5LD SOT-23 Package
		2.85 = 2.85V "Standard"			f) TC1055-2.85VCT713: 2.85V LDO Regulator, Various Temp., 5LD SOT-23 Package
		3.0 = 3.0V "Standard"			g) TC1055-3.0VCT713: 3.0V LDO Regulator, Various Temp., 5LD SOT-23 Package
		3.3 = 3.3V "Standard"			h) TC1055-3.3VCT713: 3.3V LDO Regulator, Various Temp., 5LD SOT-23 Package
		3.6 = 3.6V "Standard"			i) TC1055-3.6VCT713: 3.6V LDO Regulator, Various Temp., 5LD SOT-23 Package
		4.0 = 4.0V "Standard"			j) TC1055-4.0VCT713: 4.0V LDO Regulator, Various Temp., 5LD SOT-23 Package
		5.0 = 5.0V "Standard"			k) TC1055-5.0VCT713: 5.0V LDO Regulator, Various Temp., 5LD SOT-23 Package
		*Contact factory for other output voltage options.			a) TC1186-1.8VCT713: 1.8V LDO Regulator, Various Temp., 5LD SOT-23 Package
<b>Temperature Range:</b>	V	=	-40°C to +125°C (Various)		b) TC1186-2.5VCT713: 2.5V LDO Regulator, Various Temp., 5LD SOT-23 Package
<b>Package:</b>				CT713 = Plastic Small Outline Transistor (SOT-23), Tape and Reel	c) TC1186-2.6VCT713: 2.6V LDO Regulator, Various Temp., 5LD SOT-23 Package
					d) TC1186-2.7VCT713: 2.7V LDO Regulator, Various Temp., 5LD SOT-23 Package
					e) TC1186-2.8VCT713: 2.8V LDO Regulator, Various Temp., 5LD SOT-23 Package
					f) TC1186-2.85VCT713: 2.85V LDO Regulator, Various Temp., 5LD SOT-23 Package
					g) TC1186-3.0VCT713: 3.0V LDO Regulator, Various Temp., 5LD SOT-23 Package
					h) TC1186-3.3VCT713: 3.3V LDO Regulator, Various Temp., 5LD SOT-23 Package
					i) TC1186-3.6VCT713: 3.6V LDO Regulator, Various Temp., 5LD SOT-23 Package
					j) TC1186-4.0VCT713: 4.0V LDO Regulator, Various Temp., 5LD SOT-23 Package
					k) TC1186-5.0VCT713: 5.0V LDO Regulator, Various Temp., 5LD SOT-23 Package

# TC1054/TC1055/TC1186

---

NOTES:

---

**Note the following details of the code protection feature on Microchip devices:**

- Microchip products meet the specification contained in their particular Microchip Data Sheet.
- Microchip believes that its family of products is one of the most secure families of its kind on the market today, when used in the intended manner and under normal conditions.
- There are dishonest and possibly illegal methods used to breach the code protection feature. All of these methods, to our knowledge, require using the Microchip products in a manner outside the operating specifications contained in Microchip's Data Sheets. Most likely, the person doing so is engaged in theft of intellectual property.
- Microchip is willing to work with the customer who is concerned about the integrity of their code.
- Neither Microchip nor any other semiconductor manufacturer can guarantee the security of their code. Code protection does not mean that we are guaranteeing the product as “unbreakable.”

Code protection is constantly evolving. We at Microchip are committed to continuously improving the code protection features of our products. Attempts to break Microchip's code protection feature may be a violation of the Digital Millennium Copyright Act. If such acts allow unauthorized access to your software or other copyrighted work, you may have a right to sue for relief under that Act.

---

Information contained in this publication regarding device applications and the like is provided only for your convenience and may be superseded by updates. It is your responsibility to ensure that your application meets with your specifications. MICROCHIP MAKES NO REPRESENTATIONS OR WARRANTIES OF ANY KIND WHETHER EXPRESS OR IMPLIED, WRITTEN OR ORAL, STATUTORY OR OTHERWISE, RELATED TO THE INFORMATION, INCLUDING BUT NOT LIMITED TO ITS CONDITION, QUALITY, PERFORMANCE, MERCHANTABILITY OR FITNESS FOR PURPOSE. Microchip disclaims all liability arising from this information and its use. Use of Microchip devices in life support and/or safety applications is entirely at the buyer's risk, and the buyer agrees to defend, indemnify and hold harmless Microchip from any and all damages, claims, suits, or expenses resulting from such use. No licenses are conveyed, implicitly or otherwise, under any Microchip intellectual property rights.

#### **Trademarks**

The Microchip name and logo, the Microchip logo, dsPIC, FlashFlex, KEELOQ, KEELOQ logo, MPLAB, PIC, PICmicro, PICSTART, PIC<sup>32</sup> logo, rPIC, SST, SST Logo, SuperFlash and UNI/O are registered trademarks of Microchip Technology Incorporated in the U.S.A. and other countries.

FilterLab, Hampshire, HI-TECH C, Linear Active Thermistor, MTP, SEEVAL and The Embedded Control Solutions Company are registered trademarks of Microchip Technology Incorporated in the U.S.A.

Silicon Storage Technology is a registered trademark of Microchip Technology Inc. in other countries.

Analog-for-the-Digital Age, Application Maestro, BodyCom, chipKIT, chipKIT logo, CodeGuard, dsPICDEM, dsPICDEM.net, dsPICworks, dsSPEAK, ECAN, ECONOMONITOR, FanSense, HI-TIDE, In-Circuit Serial Programming, ICSP, Mindi, MiWi, MPASM, MPF, MPLAB Certified logo, MPLIB, MPLINK, mTouch, Omniclient Code Generation, PICC, PICC-18, PICDEM, PICDEM.net, PICkit, PICTail, REAL ICE, rFLAB, Select Mode, SQI, Serial Quad I/O, Total Endurance, TSHARC, UniWinDriver, WiperLock, ZENA and Z-Scale are trademarks of Microchip Technology Incorporated in the U.S.A. and other countries.

SQTP is a service mark of Microchip Technology Incorporated in the U.S.A.

GestIC and ULPP are registered trademarks of Microchip Technology Germany II GmbH & Co. & KG, a subsidiary of Microchip Technology Inc., in other countries.

All other trademarks mentioned herein are property of their respective companies.

© 2002-2012, Microchip Technology Incorporated, Printed in the U.S.A., All Rights Reserved.

 Printed on recycled paper.

ISBN: 978-1-62076-721-4

**QUALITY MANAGEMENT SYSTEM**  
**CERTIFIED BY DNV**  
**== ISO/TS 16949 ==**

*Microchip received ISO/TS-16949:2009 certification for its worldwide headquarters, design and wafer fabrication facilities in Chandler and Tempe, Arizona; Gresham, Oregon and design centers in California and India. The Company's quality system processes and procedures are for its PIC<sup>®</sup> MCUs and dsPIC<sup>®</sup> DSCs, KEELOQ<sup>®</sup> code hopping devices, Serial EEPROMs, microperipherals, nonvolatile memory and analog products. In addition, Microchip's quality system for the design and manufacture of development systems is ISO 9001:2000 certified.*



# MICROCHIP

## Worldwide Sales and Service

### AMERICAS

**Corporate Office**  
2355 West Chandler Blvd.  
Chandler, AZ 85224-6199  
Tel: 480-792-7200  
Fax: 480-792-7277  
Technical Support:  
<http://www.microchip.com/support>  
Web Address:  
[www.microchip.com](http://www.microchip.com)

**Atlanta**  
Duluth, GA  
Tel: 678-957-9614  
Fax: 678-957-1455

**Boston**  
Westborough, MA  
Tel: 774-760-0087  
Fax: 774-760-0088

**Chicago**  
Itasca, IL  
Tel: 630-285-0071  
Fax: 630-285-0075

**Cleveland**  
Independence, OH  
Tel: 216-447-0464  
Fax: 216-447-0643

**Dallas**  
Addison, TX  
Tel: 972-818-7423  
Fax: 972-818-2924

**Detroit**  
Farmington Hills, MI  
Tel: 248-538-2250  
Fax: 248-538-2260

**Indianapolis**  
Noblesville, IN  
Tel: 317-773-8323  
Fax: 317-773-5453

**Los Angeles**  
Mission Viejo, CA  
Tel: 949-462-9523  
Fax: 949-462-9608

**Santa Clara**  
Santa Clara, CA  
Tel: 408-961-6444  
Fax: 408-961-6445

**Toronto**  
Mississauga, Ontario,  
Canada  
Tel: 905-673-0699  
Fax: 905-673-6509

### ASIA/PACIFIC

**Asia Pacific Office**  
Suites 3707-14, 37th Floor  
Tower 6, The Gateway  
Harbour City, Kowloon  
Hong Kong  
Tel: 852-2401-1200  
Fax: 852-2401-3431

**Australia - Sydney**  
Tel: 61-2-9868-6733  
Fax: 61-2-9868-6755

**China - Beijing**  
Tel: 86-10-8569-7000  
Fax: 86-10-8528-2104

**China - Chengdu**  
Tel: 86-28-8665-5511  
Fax: 86-28-8665-7889

**China - Chongqing**  
Tel: 86-23-8980-9588  
Fax: 86-23-8980-9500

**China - Hangzhou**  
Tel: 86-571-2819-3187  
Fax: 86-571-2819-3189

**China - Hong Kong SAR**  
Tel: 852-2943-5100  
Fax: 852-2401-3431

**China - Nanjing**  
Tel: 86-25-8473-2460  
Fax: 86-25-8473-2470

**China - Qingdao**  
Tel: 86-532-8502-7355  
Fax: 86-532-8502-7205

**China - Shanghai**  
Tel: 86-21-5407-5533  
Fax: 86-21-5407-5066

**China - Shenyang**  
Tel: 86-24-2334-2829  
Fax: 86-24-2334-2393

**China - Shenzhen**  
Tel: 86-755-8864-2200  
Fax: 86-755-8203-1760

**China - Wuhan**  
Tel: 86-27-5980-5300  
Fax: 86-27-5980-5118

**China - Xian**  
Tel: 86-29-8833-7252  
Fax: 86-29-8833-7256

**China - Xiamen**  
Tel: 86-592-2388138  
Fax: 86-592-2388130

**China - Zhuhai**  
Tel: 86-756-3210040  
Fax: 86-756-3210049

### ASIA/PACIFIC

**India - Bangalore**  
Tel: 91-80-3090-4444  
Fax: 91-80-3090-4123

**India - New Delhi**  
Tel: 91-11-4160-8631  
Fax: 91-11-4160-8632

**India - Pune**  
Tel: 91-20-2566-1512  
Fax: 91-20-2566-1513

**Japan - Osaka**  
Tel: 81-6-6152-7160  
Fax: 81-6-6152-9310

**Japan - Tokyo**  
Tel: 81-3-6880-3770  
Fax: 81-3-6880-3771

**Korea - Daegu**  
Tel: 82-53-744-4301  
Fax: 82-53-744-4302

**Korea - Seoul**  
Tel: 82-2-554-7200  
Fax: 82-2-558-5932 or  
82-2-558-5934

**Malaysia - Kuala Lumpur**  
Tel: 60-3-6201-9857  
Fax: 60-3-6201-9859

**Malaysia - Penang**  
Tel: 60-4-227-8870  
Fax: 60-4-227-4068

**Philippines - Manila**  
Tel: 63-2-634-9065  
Fax: 63-2-634-9069

**Singapore**  
Tel: 65-6334-8870  
Fax: 65-6334-8850

**Taiwan - Hsin Chu**  
Tel: 886-3-5778-366  
Fax: 886-3-5770-955

**Taiwan - Kaohsiung**  
Tel: 886-7-213-7828  
Fax: 886-7-330-9305

**Taiwan - Taipei**  
Tel: 886-2-2508-8600  
Fax: 886-2-2508-0102

**Thailand - Bangkok**  
Tel: 66-2-694-1351  
Fax: 66-2-694-1350

### EUROPE

**Austria - Wels**  
Tel: 43-7242-2244-39  
Fax: 43-7242-2244-393

**Denmark - Copenhagen**  
Tel: 45-4450-2828  
Fax: 45-4485-2829

**France - Paris**  
Tel: 33-1-69-53-63-20  
Fax: 33-1-69-30-90-79

**Germany - Munich**  
Tel: 49-89-627-144-0  
Fax: 49-89-627-144-44

**Italy - Milan**  
Tel: 39-0331-742611  
Fax: 39-0331-466781

**Netherlands - Drunen**  
Tel: 31-416-690399  
Fax: 31-416-690340

**Spain - Madrid**  
Tel: 34-91-708-08-90  
Fax: 34-91-708-08-91

**UK - Wokingham**  
Tel: 44-118-921-5869  
Fax: 44-118-921-5820

11/29/12



Компания «ЭлектроПласт» предлагает заключение долгосрочных отношений при поставках импортных электронных компонентов на взаимовыгодных условиях!

Наши преимущества:

- Оперативные поставки широкого спектра электронных компонентов отечественного и импортного производства напрямую от производителей и с крупнейших мировых складов;
- Поставка более 17-ти миллионов наименований электронных компонентов;
- Поставка сложных, дефицитных, либо снятых с производства позиций;
- Оперативные сроки поставки под заказ (от 5 рабочих дней);
- Экспресс доставка в любую точку России;
- Техническая поддержка проекта, помощь в подборе аналогов, поставка прототипов;
- Система менеджмента качества сертифицирована по Международному стандарту ISO 9001;
- Лицензия ФСБ на осуществление работ с использованием сведений, составляющих государственную тайну;
- Поставка специализированных компонентов (Xilinx, Altera, Analog Devices, Intersil, Interpoint, Microsemi, Aeroflex, Peregrine, Syfer, Eurofarad, Texas Instrument, Miteq, Cobham, E2V, MA-COM, Hittite, Mini-Circuits, General Dynamics и др.);

Помимо этого, одним из направлений компании «ЭлектроПласт» является направление «Источники питания». Мы предлагаем Вам помощь Конструкторского отдела:

- Подбор оптимального решения, техническое обоснование при выборе компонента;
- Подбор аналогов;
- Консультации по применению компонента;
- Поставка образцов и прототипов;
- Техническая поддержка проекта;
- Защита от снятия компонента с производства.



#### Как с нами связаться

**Телефон:** 8 (812) 309 58 32 (многоканальный)

**Факс:** 8 (812) 320-02-42

**Электронная почта:** [org@eplast1.ru](mailto:org@eplast1.ru)

**Адрес:** 198099, г. Санкт-Петербург, ул. Калинина, дом 2, корпус 4, литера А.