

50 mA, 100 mA and 150 mA CMOS LDOs with Shutdown and ERROR Output

Features

- Low Ground Current for Longer Battery Life
- Low Dropout Voltage
- Choice of 50 mA (TC1054), 100 mA (TC1055) and 150 mA (TC1186) Output
- High Output Voltage Accuracy
- Standard or Custom Output Voltages:
 - 1.8V, 2.5V, 2.6V, 2.7V, 2.8V, 2.85V, 3.0V, 3.3V, 3.6V, 4.0V, 5.0V
- Power-Saving Shutdown Mode
- **ERROR** Output Can Be Used as a Low-Battery Detector or Microcontroller-Reset Generator
- Overcurrent and Overtemperature Protection
- 5-Pin SOT-23 Package
- Pin-Compatible Upgrades for Bipolar Regulators

Applications

- Battery Operated Systems
- Portable Computers
- Medical Instruments
- Instrumentation
- Cellular/GSM/PHS Phones
- Linear Post-Regulators for SMPS
- Pagers

Typical Application

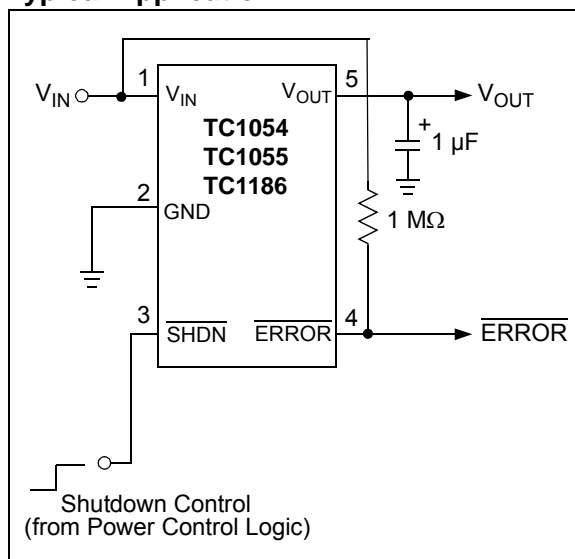

General Description

The TC1054, TC1055 and TC1186 are high accuracy (typically $\pm 0.5\%$) CMOS upgrades for older (bipolar) low dropout regulators. Designed specifically for battery-operated systems, the devices' CMOS construction minimizes ground current, extending battery life. Total supply current is typically 50 μA at full load (20 to 60 times lower than in bipolar regulators).

The devices' key features include low noise operation, low dropout voltage – typically 85 mV (TC1054), 180 mV (TC1055) and 270 mV (TC1186) at full load — and fast response to step changes in load. An error output (**ERROR**) is asserted when the devices are out-of-regulation (due to a low input voltage or excessive output current). **ERROR** can be used as a low battery warning or as a processor **RESET** signal (with the addition of an external RC network). Supply current is reduced to 0.5 μA (maximum), with both **V_{OUT}** and **ERROR** disabled when the shutdown input is low. The devices incorporate both overtemperature and over-current protection.

The TC1054, TC1055 and TC1186 are stable with an output capacitor of only 1 μF , and have a maximum output current of 50 mA, 100 mA and 150 mA, respectively. For higher output current regulators, please refer to the TC1173 ($I_{\text{OUT}} = 300 \text{ mA}$) data sheet (DS21632).

Package Type

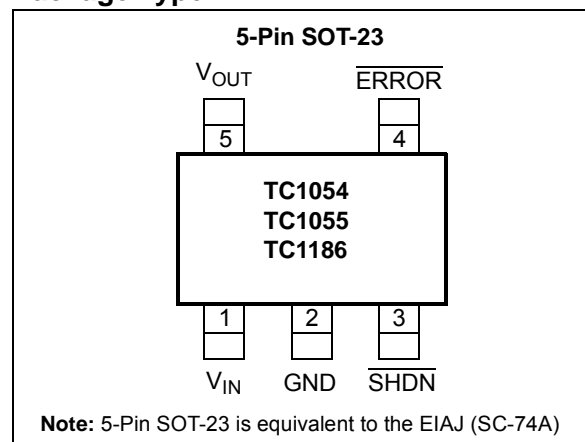

TC1054/TC1055/TC1186

1.0 ELECTRICAL CHARACTERISTICS

Absolute Maximum Ratings †

Input Voltage	6.75V
Output Voltage	(-0.3V) to (V _{IN} + 0.3V)
Power Dissipation	Internally Limited (Note 6)
Maximum Voltage on Any Pin	V _{IN} + 0.3V to -0.3V
Operating Junction Temperature Range ..	-40°C < T _J < +125°C
Storage Temperature.....	-65°C to +150°C

† **Notice:** Stresses above those listed under "Absolute Maximum Ratings" may cause permanent damage to the device. These are stress ratings only and functional operation of the device at these or any other conditions above those indicated in the operation sections of the specifications is not implied. Exposure to Absolute Maximum Rating conditions for extended periods may affect device reliability.

DC CHARACTERISTICS

Electrical Specifications: Unless otherwise noted, V_{IN} = V_{OUT} + 1V, I_L = 100 μA, C_L = 3.3 μF, SHDN > V_{IH}, T_A = +25°C. **Boldface** type specifications apply for junction temperatures of -40°C to +125°C.

Parameters	Sym	Min	Typ	Max	Units	Conditions
Input Operating Voltage	V _{IN}	2.7	—	6.50	V	Note 8
Maximum Output Current	I _{OUTMAX}	50	—	—	mA	TC1054
		100	—	—		TC1055
		150	—	—		TC1186
Output Voltage	V _{OUT}	V_R - 2.5%	V _R ±0.5%	V_R + 2.5%	V	Note 1
V _{OUT} Temperature Coefficient	TCV _{OUT}	—	20	—	ppm/°C	Note 2
		—	40	—		
Line Regulation	ΔV _{OUT} /ΔV _{IN}	—	0.05	0.35	%	(V _R + 1V) ≤ V _{IN} ≤ 6V
Load Regulation						
TC1054; TC1055	ΔV _{OUT} /V _{OUT}	—	0.5	2	%	(Note 3) I _L = 0.1 mA to I _{OUTMAX}
TC1186		—	0.5	3		

Note 1: V_R is the regulator output voltage setting. For example: V_R = 1.8V, 2.5V, 2.7V, 2.85V, 3.0V, 3.3V, 3.6V, 4.0V, 5.0V.

2:
$$TC V_{OUT} = \frac{(V_{OUTMAX} - V_{OUTMIN}) \times 10^6}{V_{OUT} \times \Delta T}$$

- 3:** Regulation is measured at a constant junction temperature using low-duty-cycle pulse testing. Load regulation is tested over a load range from 0.1 mA to the maximum specified output current. Changes in output voltage due to heating effects are covered by the thermal regulation specification.
- 4:** Dropout voltage is defined as the input to output differential at which the output voltage drops 2% below its nominal value.
- 5:** Thermal Regulation is defined as the change in output voltage at a time T after a change in power dissipation is applied, excluding load or line regulation effects. Specifications are for a current pulse equal to I_{LMAX} at V_{IN} = 6V for T = 10 ms.
- 6:** The maximum allowable power dissipation is a function of ambient temperature, the maximum allowable junction temperature and the thermal resistance from junction-to-air (i.e., T_A, T_J, θ_{JA}). Exceeding the maximum allowable power dissipation causes the device to initiate thermal shutdown. See **Section 5.0 "Thermal Considerations"** for more details.
- 7:** Hysteresis voltage is referenced by V_R.
- 8:** The minimum V_{IN} has to justify the conditions: V_{IN} ≥ V_R + V_{DROPOUT} and V_{IN} ≥ 2.7V for I_L = 0.1 mA to I_{OUTMAX}.
- 9:** Apply for junction temperatures of -40°C to +85°C.

TC1054/TC1055/TC1186

DC CHARACTERISTICS (CONTINUED)

Electrical Specifications: Unless otherwise noted, $V_{IN} = V_{OUT} + 1V$, $I_L = 100 \mu A$, $C_L = 3.3 \mu F$, $\overline{SHDN} > V_{IH}$, $T_A = +25^\circ C$. **Boldface** type specifications apply for junction temperatures of $-40^\circ C$ to $+125^\circ C$.

Parameters	Sym	Min	Typ	Max	Units	Conditions
Dropout Voltage	$V_{IN} - V_{OUT}$	—	2	—	mV	$I_L = 100 \mu A$
		—	65	—		$I_L = 20 mA$
		—	85	120		$I_L = 50 mA$
		—	180	250		$I_L = 100 mA$
		—	270	400		$I_L = 150 mA$ (Note 4)
TC1055; TC1186						
TC1186						
Supply Current	I_{IN}	—	50	80	μA	$\overline{SHDN} = V_{IH}$, $I_L = 0 \mu A$ (Note 9)
Shutdown Supply Current	I_{INSD}	—	0.05	0.5	μA	$\overline{SHDN} = 0V$
Power Supply Rejection Ratio	PSRR	—	64	—	dB	$f \leq 1 kHz$
Output Short Circuit Current	I_{OUTSC}	—	300	450	mA	$V_{OUT} = 0V$
Thermal Regulation	$\Delta V_{OUT}/\Delta P_D$	—	0.04	—	V/W	Notes 5, 6
Thermal Shutdown Die Temperature	T_{SD}	—	160	—	$^\circ C$	
Thermal Shutdown Hysteresis	ΔT_{SD}	—	10	—	$^\circ C$	
Output Noise	eN	—	260	—	nV/ \sqrt{Hz}	$I_L = I_{OUTMAX}$
SHDN Input						
SHDN Input High Threshold	V_{IH}	45	—	—	% V_{IN}	$V_{IN} = 2.5V$ to $6.5V$
SHDN Input Low Threshold	V_{IL}	—	—	15	% V_{IN}	$V_{IN} = 2.5V$ to $6.5V$
ERROR Output						
Minimum V_{IN} Operating Voltage	V_{INMIN}	1.0	—	—	V	
Output Logic Low Voltage	V_{OL}	—	—	400	mV	1 mA Flows to \overline{ERROR}
ERROR Threshold Voltage	V_{TH}	—	$0.95 \times V_R$	—	V	See Figure 4-2
ERROR Positive Hysteresis	V_{HYS}	—	50	—	mV	Note 7
V_{OUT} to \overline{ERROR} Delay	t_{DELAY}	—	2.5	—	ms	V_{OUT} falling from V_R to $V_R - 10\%$

Note 1: V_R is the regulator output voltage setting. For example: $V_R = 1.8V, 2.5V, 2.7V, 2.85V, 3.0V, 3.3V, 3.6V, 4.0V, 5.0V$.

2:
$$TC V_{OUT} = \frac{(V_{OUTMAX} - V_{OUTMIN}) \times 10^6}{V_{OUT} \times \Delta T}$$

- 3:** Regulation is measured at a constant junction temperature using low-duty-cycle pulse testing. Load regulation is tested over a load range from 0.1 mA to the maximum specified output current. Changes in output voltage due to heating effects are covered by the thermal regulation specification.
- 4:** Dropout voltage is defined as the input to output differential at which the output voltage drops 2% below its nominal value.
- 5:** Thermal Regulation is defined as the change in output voltage at a time T after a change in power dissipation is applied, excluding load or line regulation effects. Specifications are for a current pulse equal to I_{LMAX} at $V_{IN} = 6V$ for $T = 10 ms$.
- 6:** The maximum allowable power dissipation is a function of ambient temperature, the maximum allowable junction temperature and the thermal resistance from junction-to-air (i.e., T_A, T_J, θ_{JA}). Exceeding the maximum allowable power dissipation causes the device to initiate thermal shutdown. See **Section 5.0 "Thermal Considerations"** for more details.
- 7:** Hysteresis voltage is referenced by V_R .
- 8:** The minimum V_{IN} has to justify the conditions: $V_{IN} \geq V_R + V_{DROPOUT}$ and $V_{IN} \geq 2.7V$ for $I_L = 0.1 mA$ to I_{OUTMAX} .
- 9:** Apply for junction temperatures of $-40^\circ C$ to $+85^\circ C$.

TC1054/TC1055/TC1186

2.0 TYPICAL PERFORMANCE CURVES

Note: The graphs and tables provided following this note are a statistical summary based on a limited number of samples and are provided for informational purposes only. The performance characteristics listed herein are not tested or guaranteed. In some graphs or tables, the data presented may be outside the specified operating range (e.g., outside specified power supply range) and therefore outside the warranted range.

Note: Unless otherwise indicated, $V_{IN} = V_{OUT} + 1V$, $I_L = 100 \mu A$, $C_L = 3.3 \mu F$, $\overline{SHDN} > V_{IH}$, $T_A = +25^\circ C$.

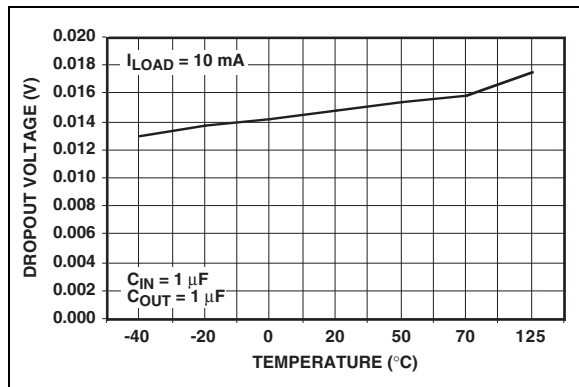

FIGURE 2-1: Dropout Voltage vs. Temperature ($I_{LOAD} = 10 \text{ mA}$).

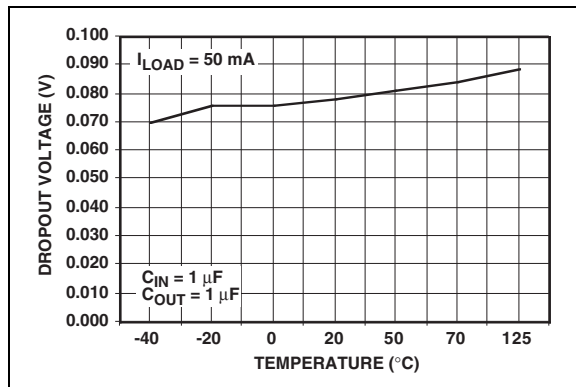

FIGURE 2-4: Dropout Voltage vs. Temperature ($I_{LOAD} = 50 \text{ mA}$).

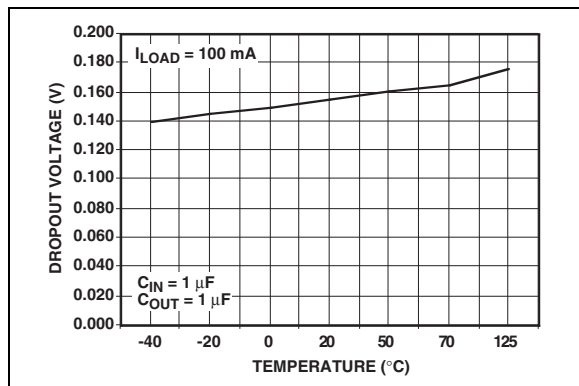

FIGURE 2-2: Dropout Voltage vs. Temperature ($I_{LOAD} = 100 \text{ mA}$).

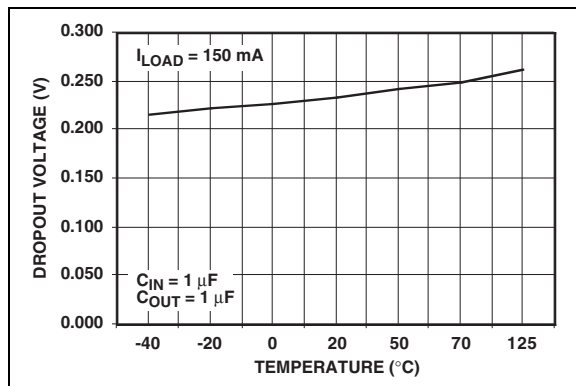

FIGURE 2-5: Dropout Voltage vs. Temperature ($I_{LOAD} = 150 \text{ mA}$).

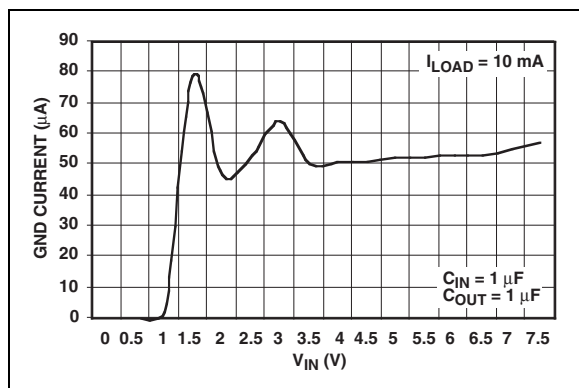

FIGURE 2-3: Ground Current vs. V_{IN} ($I_{LOAD} = 10 \text{ mA}$).

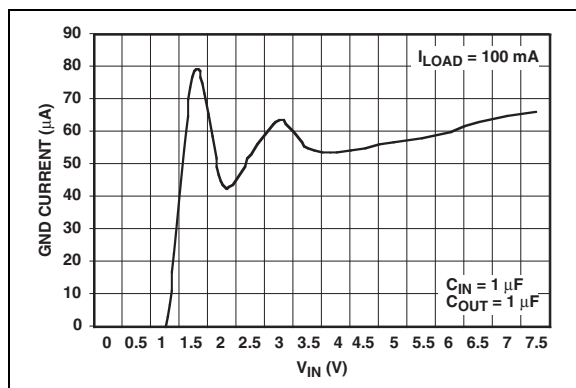

FIGURE 2-6: Ground Current vs. V_{IN} ($I_{LOAD} = 100 \text{ mA}$).

TC1054/TC1055/TC1186

Note: Unless otherwise indicated, $V_{IN} = V_{OUT} + 1V$, $I_L = 100 \mu A$, $C_L = 3.3 \mu F$, $\overline{SHDN} > V_{IH}$, $T_A = +25^\circ C$.

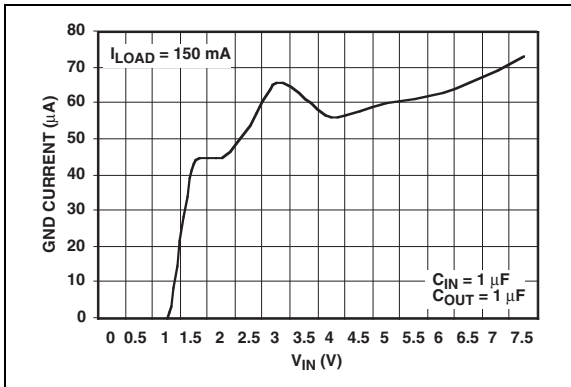

FIGURE 2-7: Ground Current vs. V_{IN} ($I_{LOAD} = 150 \text{ mA}$).

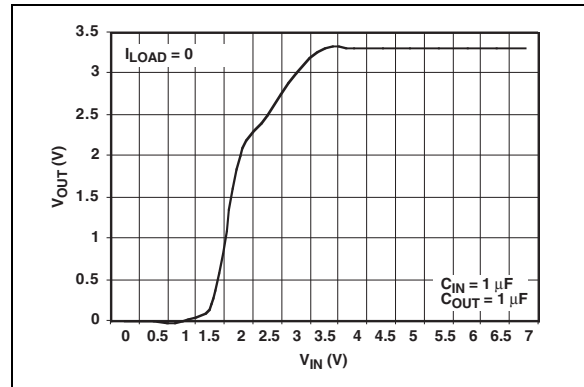

FIGURE 2-10: V_{OUT} vs. V_{IN} ($I_{LOAD} = 0 \text{ mA}$).

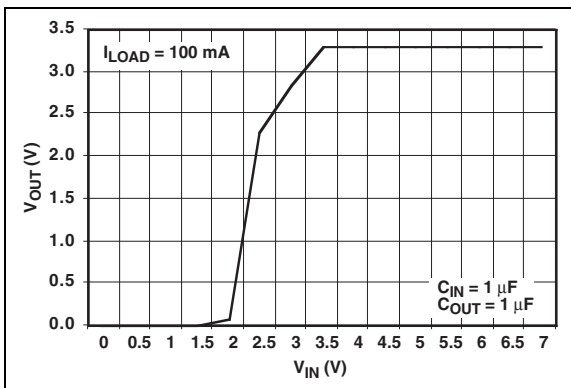

FIGURE 2-8: V_{OUT} vs. V_{IN} ($I_{LOAD} = 100 \text{ mA}$).

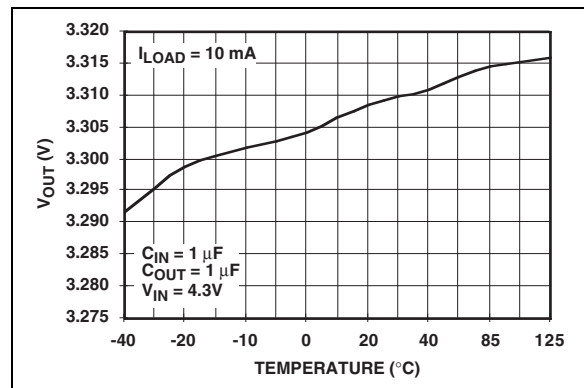

FIGURE 2-11: Output Voltage (3.3V) vs. Temperature ($I_{LOAD} = 10 \text{ mA}$).

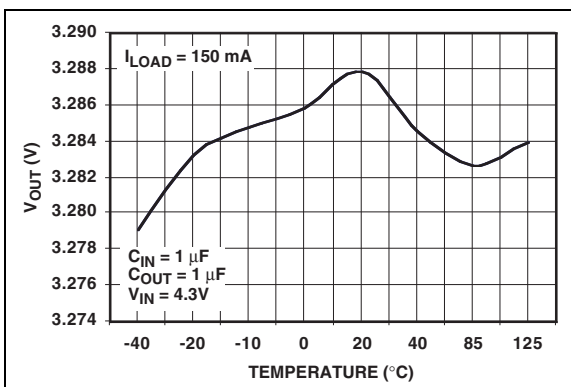

FIGURE 2-9: V_{OUT} vs. V_{IN} ($I_{LOAD} = 150 \text{ mA}$).

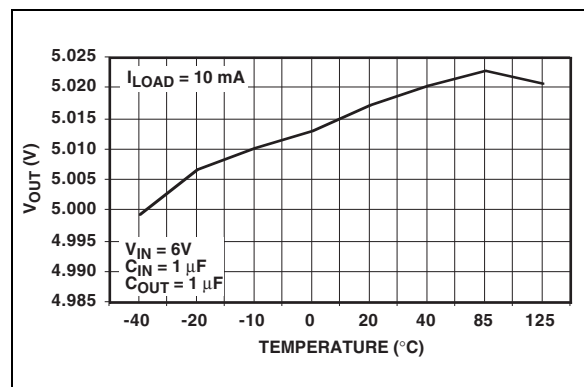

FIGURE 2-12: Output Voltage (5V) vs. Temperature ($I_{LOAD} = 10 \text{ mA}$).

TC1054/TC1055/TC1186

Note: Unless otherwise indicated, $V_{IN} = V_{OUT} + 1V$, $I_L = 100 \mu A$, $C_L = 3.3 \mu F$, $\overline{SHDN} > V_{IH}$, $T_A = +25^\circ C$.

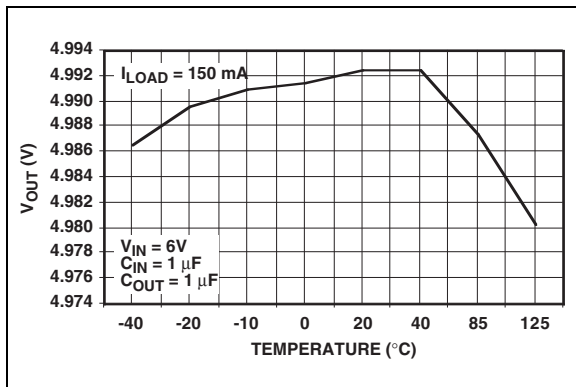

FIGURE 2-13: Output Voltage (5V) vs. Temperature ($I_{LOAD} = 10 \text{ mA}$).

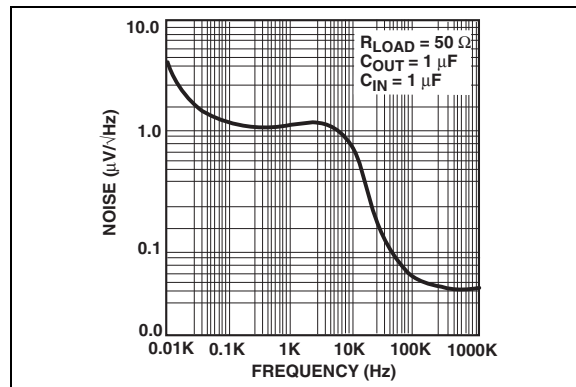

FIGURE 2-16: Output Noise vs. Frequency.

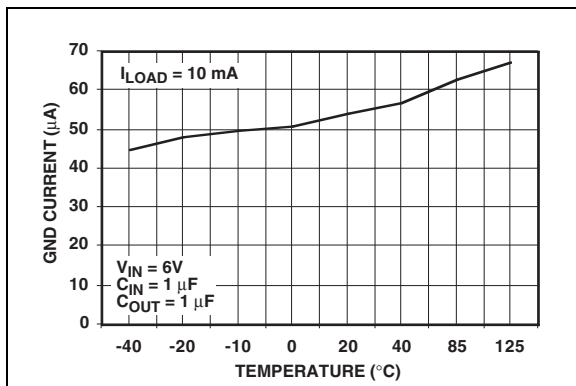

FIGURE 2-14: GND Current vs. Temperature ($I_{LOAD} = 10 \text{ mA}$).

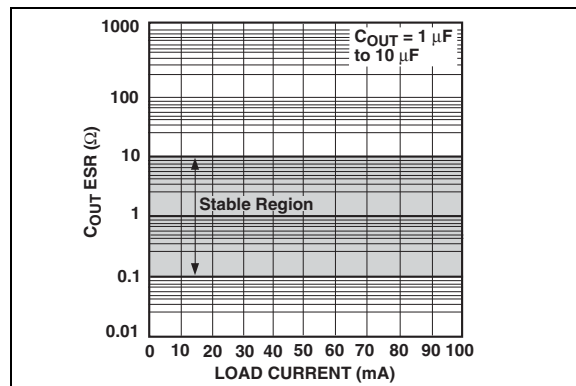

FIGURE 2-17: Stability Region vs. Load Current.

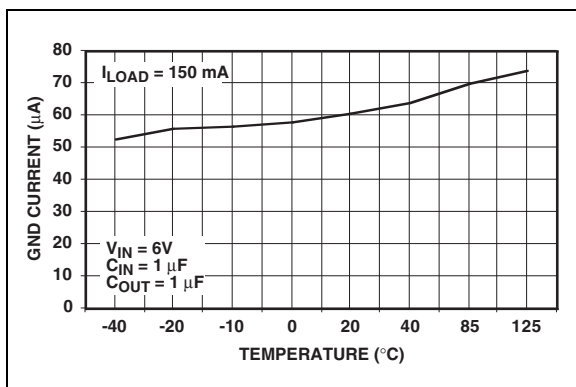

FIGURE 2-15: GND Current vs. Temperature ($I_{LOAD} = 150 \text{ mA}$).

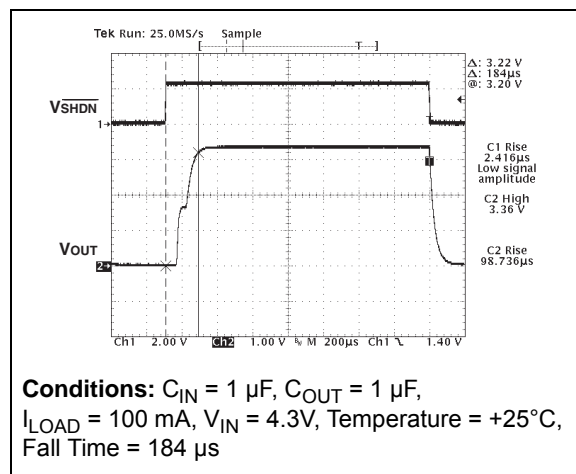
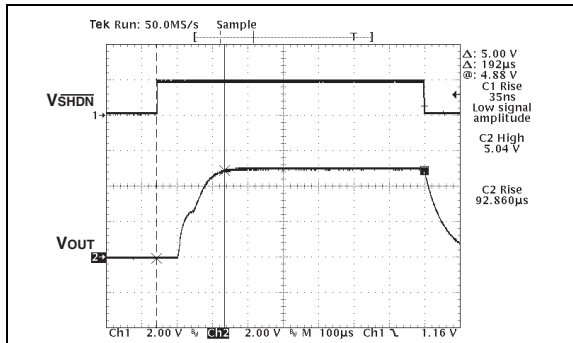

FIGURE 2-18: Measure Rise Time of 3.3V LDO.

TC1054/TC1055/TC1186

Note: Unless otherwise indicated, $V_{IN} = V_{OUT} + 1V$, $I_L = 100 \mu A$, $C_L = 3.3 \mu F$, $\overline{SHDN} > V_{IH}$, $T_A = +25^\circ C$.



Conditions: $C_{IN} = 1 \mu F$, $C_{OUT} = 1 \mu F$,
 $I_{LOAD} = 100 \text{ mA}$, $V_{IN} = 6V$, Temperature = $+25^\circ C$,
 Fall Time = 192 μs

FIGURE 2-19: Measure Rise Time of 5.0V LDO.

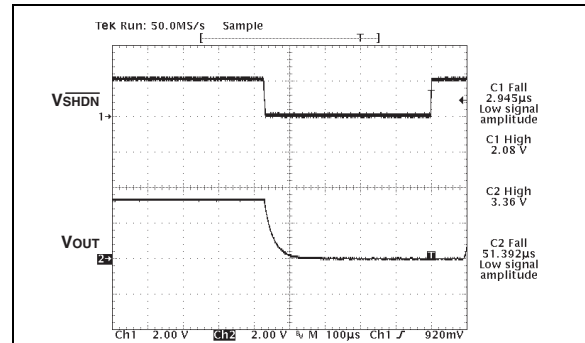

Conditions: $C_{IN} = 1 \mu F$, $C_{OUT} = 1 \mu F$,
 $I_{LOAD} = 100 \text{ mA}$, $V_{IN} = 4.3V$, Temperature = $+25^\circ C$,
 Fall Time = 52 μs

FIGURE 2-21: Measure Fall Time of 3.3V LDO.

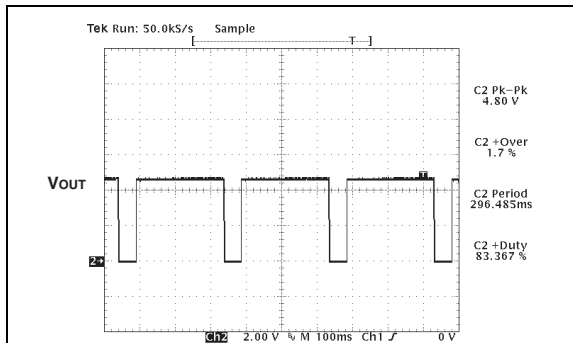

Conditions: $V_{IN} = 6V$, $C_{IN} = 0 \mu F$, $C_{OUT} = 1 \mu F$

I_{LOAD} was increased until temperature of die reached about $+160^\circ C$, at which time integrated thermal protection circuitry shuts the regulator off when die temperature exceeds approximately $+160^\circ C$. The regulator remains off until die temperature drops to approximately $+150^\circ C$.

FIGURE 2-20: Thermal Shutdown Response of 5.0V LDO.

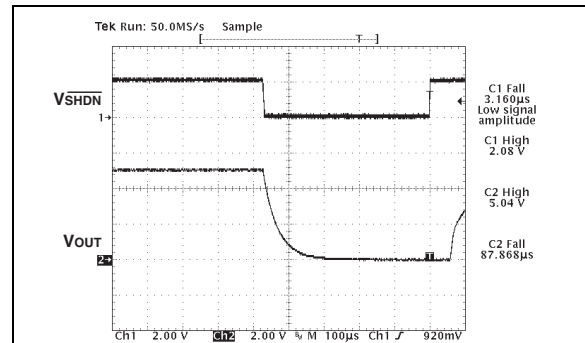

Conditions: $C_{IN} = 1 \mu F$, $C_{OUT} = 1 \mu F$,
 $I_{LOAD} = 100 \text{ mA}$, $V_{IN} = 6V$, Temperature = $+25^\circ C$,
 Fall Time = 88 μs

FIGURE 2-22: Measure Fall Time of 5.0V LDO.

TC1054/TC1055/TC1186

3.0 PIN DESCRIPTIONS

The descriptions of the pins are listed in [Table 3-1](#).

TABLE 3-1: PIN FUNCTION TABLE

Pin No. SOT-23	Symbol	Description
1	V_{IN}	Unregulated supply input
2	GND	Ground terminal
3	$\overline{\text{SHDN}}$	Shutdown control input
4	$\overline{\text{ERROR}}$	Out-of-Regulation Flag (Open-drain output)
5	V_{OUT}	Regulated voltage output

3.1 Unregulated Supply Input (V_{IN})

Connect unregulated input supply to the V_{IN} pin. If there is a large distance between the input supply and the LDO regulator, some input capacitance is necessary for proper operation. A 1 μF capacitor connected from V_{IN} to ground is recommended for most applications.

3.2 Ground Terminal (GND)

Connect the unregulated input supply ground return to GND. Also connect the negative side of the 1 μF typical input decoupling capacitor close to GND and the negative side of the output capacitor C_{OUT} to GND.

3.3 Shutdown Control Input ($\overline{\text{SHDN}}$)

The regulator is fully enabled when a logic-high is applied to $\overline{\text{SHDN}}$. The regulator enters shutdown when a logic-low is applied to $\overline{\text{SHDN}}$. During shutdown, output voltage falls to zero, $\overline{\text{ERROR}}$ is open-circuited and supply current is reduced to 0.5 μA (maximum).

3.4 Out Of Regulation Flag ($\overline{\text{ERROR}}$)

$\overline{\text{ERROR}}$ goes low when V_{OUT} is out-of-tolerance by approximately -5%.

3.5 Regulated Voltage Output (V_{OUT})

Connect the output load to V_{OUT} of the LDO. Also connect the positive side of the LDO output capacitor as close as possible to the V_{OUT} pin.

4.0 DETAILED DESCRIPTION

The TC1054, TC1055 and TC1186 are precision fixed output voltage regulators (If an adjustable version is desired, please see the TC1070/TC1071/TC1187 data sheet (DS21353)). Unlike bipolar regulators, the TC1054, TC1055 and TC1186 supply current does not increase with load current.

Figure 4-1 shows a typical application circuit, where the regulator is enabled any time the shutdown input (SHDN) is at or above V_{IH} , and shutdown (disabled) when SHDN is at or below V_{IL} . SHDN may be controlled by a CMOS logic gate or I/O port of a microcontroller. If the SHDN input is not required, it should be connected directly to the input supply. While in Shutdown, supply current decreases to 0.05 μ A (typical), V_{OUT} falls to zero volts, and \overline{ERROR} is open-circuited.

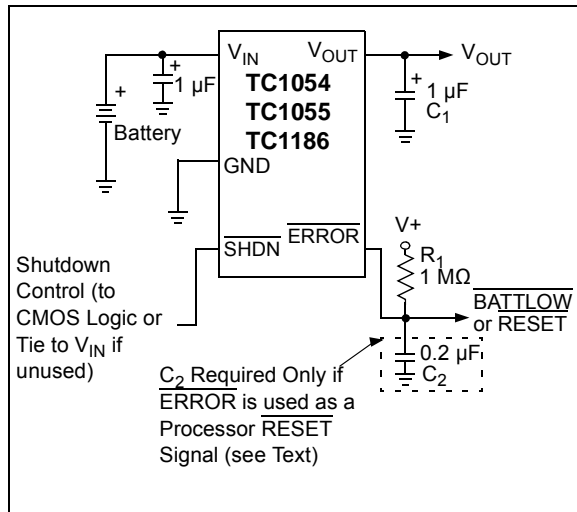

FIGURE 4-1: Typical Application Circuit.

4.1 \overline{ERROR} Open-Drain Output

\overline{ERROR} is driven low whenever V_{OUT} falls out of regulation by more than -5% (typical). This condition may be caused by low input voltage, output current limiting or thermal limiting. The \overline{ERROR} threshold is 5% below rated V_{OUT} , regardless of the programmed output voltage value (e.g. $\overline{ERROR} = V_{OL}$ at 4.75V (typical) for a 5.0V regulator and 2.85V (typical) for a 3.0V regulator). \overline{ERROR} output operation is shown in Figure 4-2.

Note that \overline{ERROR} is active when V_{OUT} falls to V_{TH} and inactive when V_{OUT} rises above V_{TH} by V_{HYS} .

As shown in Figure 4-1, \overline{ERROR} can be used either as a battery low flag or as a processor \overline{RESET} signal (with the addition of timing capacitor C_2). $R_1 \times C_2$ should be chosen to maintain \overline{ERROR} below V_{IH} of the processor \overline{RESET} input for at least 200 ms to allow time for the system to stabilize. Pull-up resistor R_1 can be tied to V_{OUT} , V_{IN} or any other voltage less than $(V_{IN} + 0.3V)$.

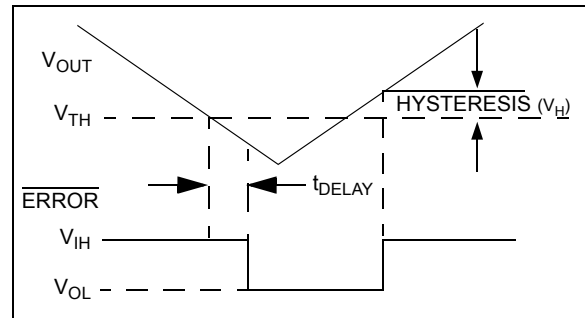

FIGURE 4-2: \overline{ERROR} Output Operation.

4.2 Output Capacitor

A 1 μ F (minimum) capacitor from V_{OUT} to ground is recommended. The output capacitor should have an effective series resistance greater than 0.1 Ω and less than 10.0 Ω , with a resonant frequency above 1 MHz. A 1 μ F capacitor should be connected from V_{IN} to GND if there is more than 10 inches of wire between the regulator and the AC filter capacitor, or if a battery is used as the power source. Aluminum electrolytic or tantalum capacitor types can be used (since many aluminum electrolytic capacitors freeze at approximately -30°C, solid tantalums are recommended for applications operating below -25°C). When operating from sources other than batteries, supply-noise rejection and transient response can be improved by increasing the value of the input and output capacitors and employing passive filtering techniques.

TC1054/TC1055/TC1186

5.0 THERMAL CONSIDERATIONS

5.1 Thermal Shutdown

Integrated thermal protection circuitry shuts the regulator off when die temperature exceeds +160°C. The regulator remains off until the die temperature drops to approximately +150°C.

5.2 Power Dissipation

The amount of power the regulator dissipates is primarily a function of input voltage, output voltage and output current. The following equation is used to calculate worst-case actual power dissipation:

EQUATION 5-1:

$$P_D \approx (V_{INMAX} - V_{OUTMIN})I_{LOADMAX}$$

Where:

P_D = Worst-case actual power dissipation

V_{INmax} = Maximum voltage on V_{IN}

V_{OUTmin} = Minimum regulator output voltage

$I_{LOADmax}$ = Maximum output (load) current

The maximum allowable power dissipation (Equation 5-2) is a function of the maximum ambient temperature (T_{AMAX}), the maximum allowable die temperature (T_{JMAX}) and the thermal resistance from junction-to-air (θ_{JA}). The 5-Pin SOT-23 package has a θ_{JA} of approximately 220°C/Watt.

EQUATION 5-2:

$$P_{DMAX} = \frac{(T_{JMAX} - T_{AMAX})}{\theta_{JA}}$$

Where all terms are previously defined.

Equation 5-1 can be used in conjunction with Equation 5-2 to ensure regulator thermal operation is within limits.

For example:

Given:

$$V_{INMAX} = 3.0V + 5\%$$

$$V_{OUTMIN} = 2.7V - 2.5\%$$

$$I_{LOADMAX} = 40 \text{ mA}$$

$$T_{JMAX} = +125^\circ\text{C}$$

$$T_{AMAX} = +55^\circ\text{C}$$

- Find:
1. Actual power dissipation
 2. Maximum allowable dissipation

Actual power dissipation:

$$\begin{aligned} P_D &\approx (V_{INMAX} - V_{OUTMIN})I_{LOADMAX} \\ &= [(3.0 \times 1.05) - (2.7 \times 0.975)]40 \times 10^{-3} \\ &= 20.7 \text{ mW} \end{aligned}$$

Maximum allowable power dissipation:

$$\begin{aligned} P_{DMAX} &= \frac{(T_{JMAX} - T_{AMAX})}{\theta_{JA}} \\ &= \frac{(125 - 55)}{220} \\ &= 318 \text{ mW} \end{aligned}$$

In this example, the TC1054 dissipates a maximum of 20.7 mW; below the allowable limit of 318 mW. In a similar manner, Equation 5-1 and Equation 5-2 can be used to calculate maximum current and/or input voltage limits.

5.3 Layout Considerations

The primary path of heat conduction out of the package is via the package leads. Layouts having a ground plane, wide traces at the pads and wide power supply bus lines, combine to lower θ_{JA} and increase the maximum allowable power dissipation limit.

6.0 PACKAGING INFORMATION

6.1 Package Marking Information

5-Lead SOT-23



Example

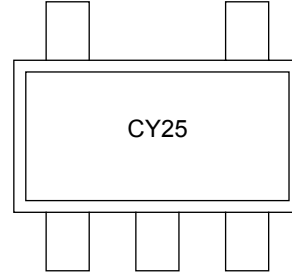

(V)	TC1054 Code	TC1055 Code	TC1186 Code
1.8	CYNN	DYNN	PYNN
2.5	C1NN	D1NN	P1NN
2.6	CTNN	DTNN	PVNN
2.7	C2NN	D2NN	P2NN
2.8	CZNN	DZNN	PZNN
2.85	C8NN	D8NN	P8NN
3.0	C3NN	D3NN	P3NN
3.3	C4NN	D4NN	P5NN
3.6	C9NN	D9NN	P9NN
4.0	C0NN	D0NN	P0NN
5.0	C6NN	D6NN	P7NN

Legend: XX...X Customer-specific information
 Y Year code (last digit of calendar year)
 YY Year code (last 2 digits of calendar year)
 WW Week code (week of January 1 is week '01')
 NNN Alphanumeric traceability code
 (e3) Pb-free JEDEC designator for Matte Tin (Sn)
 * This package is Pb-free. The Pb-free JEDEC designator (e3) can be found on the outer packaging for this package.

Note: In the event the full Microchip part number cannot be marked on one line, it will be carried over to the next line, thus limiting the number of available characters for customer-specific information.

TC1054/TC1055/TC1186

5-Lead Plastic Small Outline Transistor (CT) [SOT-23]

Note: For the most current package drawings, please see the Microchip Packaging Specification located at <http://www.microchip.com/packaging>

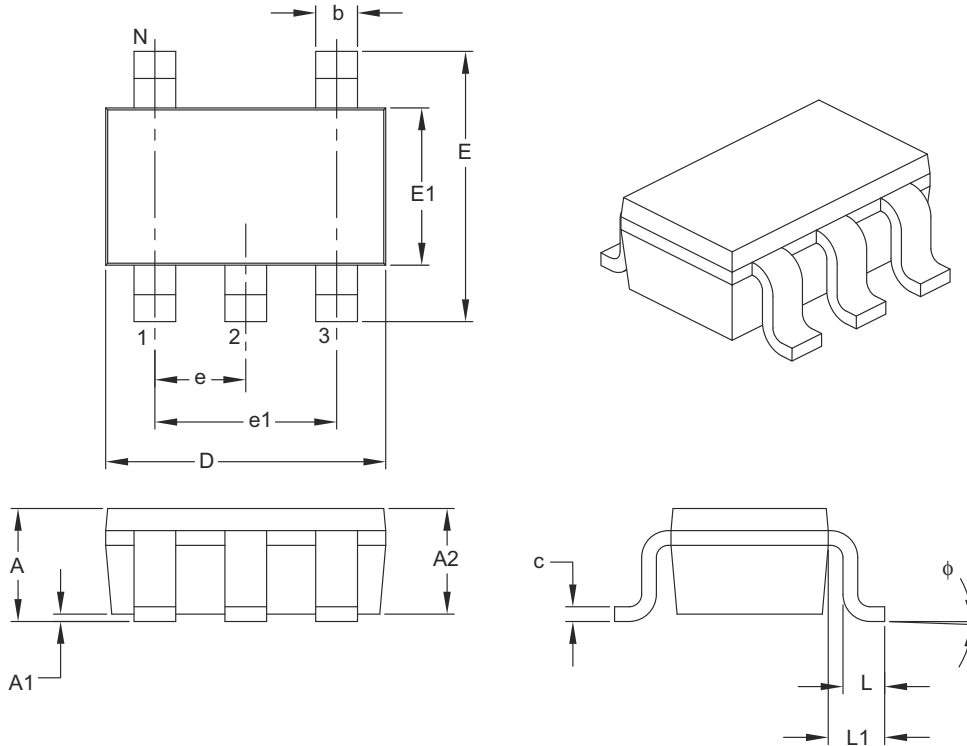

		Units	MILLIMETERS		
Dimension Limits			MIN	NOM	MAX
Number of Pins	N		5		
Lead Pitch	e		0.95 BSC		
Outside Lead Pitch	e1		1.90 BSC		
Overall Height	A	0.90	–		1.45
Molded Package Thickness	A2	0.89	–		1.30
Standoff	A1	0.00	–		0.15
Overall Width	E	2.20	–		3.20
Molded Package Width	E1	1.30	–		1.80
Overall Length	D	2.70	–		3.10
Foot Length	L	0.10	–		0.60
Footprint	L1	0.35	–		0.80
Foot Angle	ϕ	0°	–		30°
Lead Thickness	c	0.08	–		0.26
Lead Width	b	0.20	–		0.51

Notes:

- Dimensions D and E1 do not include mold flash or protrusions. Mold flash or protrusions shall not exceed 0.127 mm per side.
- Dimensioning and tolerancing per ASME Y14.5M.

BSC: Basic Dimension. Theoretically exact value shown without tolerances.

Microchip Technology Drawing C04-091B

5-Lead Plastic Small Outline Transistor (CT) [SOT-23]

Note: For the most current package drawings, please see the Microchip Packaging Specification located at <http://www.microchip.com/packaging>

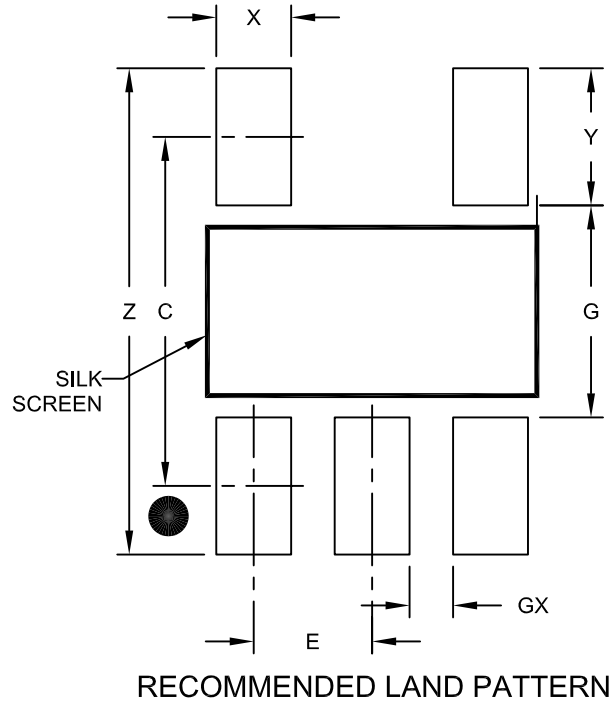

Dimension Limits	Units	MILLIMETERS		
		MIN	NOM	MAX
Contact Pitch	E	0.95 BSC		
Contact Pad Spacing	C		2.80	
Contact Pad Width (X5)	X			0.60
Contact Pad Length (X5)	Y			1.10
Distance Between Pads	G	1.70		
Distance Between Pads	GX	0.35		
Overall Width	Z			3.90

Notes:

1. Dimensioning and tolerancing per ASME Y14.5M

BSC: Basic Dimension. Theoretically exact value shown without tolerances.

Microchip Technology Drawing No. C04-2091A

TC1054/TC1055/TC1186

NOTES:

APPENDIX A: REVISION HISTORY

Revision E (December 2012)

The following is the list of modifications:

1. Updated the Input Voltage value in [Absolute Maximum Ratings †](#) section.
2. Updated [Section 6.0, Packaging Information](#).
3. Updated [Product Identification System](#).

Revision D (February 2007)

- Corrected standard output voltages on page 1 and in [Section , Product Identification System](#).
- Added T_{DELAY} parameter in DC Characteristics table in [Section 1.0, Electrical Characteristics](#).
- Changes to [Figure 4-2](#).
- [Section 6.0, Packaging Information](#): Corrected SOT-23 Packaging Information.

Revision C (March 2003)

- Undocumented changes.

Revision B (May 2002)

- Undocumented changes.

Revision A (March 2002)

- Original Release of this Document.

TC1054/TC1055/TC1186

NOTES:

TC1054/TC1055/TC1186

PRODUCT IDENTIFICATION SYSTEM

To order or obtain information, e.g., on pricing or delivery, refer to the factory or the listed sales office.

PART NO.	—	X.X	X	XXXXX	
Device		Output Voltage	Temperature Range	Package	
Device: TC1054: 50 mA LDO with Shutdown and <u>ERROR</u> output TC1055: 100 mA LDO with Shutdown and <u>ERROR</u> output TC1186: 150 mA LDO with Shutdown and <u>ERROR</u> output					Examples: a) TC1054-1.8VCT713: 1.8V LDO Regulator, Various Temp., 5LD SOT-23 Package b) TC1054-2.5VCT713: 2.5V LDO Regulator, Various Temp., 5LD SOT-23 Package c) TC1054-2.6VCT713: 2.6V LDO Regulator, Various Temp., 5LD SOT-23 Package d) TC1054-2.7VCT713: 2.7V LDO Regulator, Various Temp., 5LD SOT-23 Package e) TC1054-2.8VCT713: 2.8V LDO Regulator, Various Temp., 5LD SOT-23 Package f) TC1054-2.85VCT713: 2.85V LDO Regulator, Various Temp., 5LD SOT-23 Package g) TC1054-3.0VCT713: 3.0V LDO Regulator, Various Temp., 5LD SOT-23 Package h) TC1054-3.3VCT713: 3.3V LDO Regulator, Various Temp., 5LD SOT-23 Package i) TC1054-3.6VCT713: 3.6V LDO Regulator, Various Temp., 5LD SOT-23 Package j) TC1054-4.0VCT713: 4.0V LDO Regulator, Various Temp., 5LD SOT-23 Package k) TC1054-5.0VCT713: 5.0V LDO Regulator, Various Temp., 5LD SOT-23 Package a) TC1055-1.8VCT713: 1.8V LDO Regulator, Various Temp., 5LD SOT-23 Package b) TC1055-2.5VCT713: 2.5V LDO Regulator, Various Temp., 5LD SOT-23 Package c) TC1055-2.6VCT713: 2.6V LDO Regulator, Various Temp., 5LD SOT-23 Package d) TC1055-2.7VCT713: 2.7V LDO Regulator, Various Temp., 5LD SOT-23 Package e) TC1055-2.8VCT713: 2.8V LDO Regulator, Various Temp., 5LD SOT-23 Package f) TC1055-2.85VCT713: 2.85V LDO Regulator, Various Temp., 5LD SOT-23 Package g) TC1055-3.0VCT713: 3.0V LDO Regulator, Various Temp., 5LD SOT-23 Package h) TC1055-3.3VCT713: 3.3V LDO Regulator, Various Temp., 5LD SOT-23 Package i) TC1055-3.6VCT713: 3.6V LDO Regulator, Various Temp., 5LD SOT-23 Package j) TC1055-4.0VCT713: 4.0V LDO Regulator, Various Temp., 5LD SOT-23 Package k) TC1055-5.0VCT713: 5.0V LDO Regulator, Various Temp., 5LD SOT-23 Package a) TC1186-1.8VCT713: 1.8V LDO Regulator, Various Temp., 5LD SOT-23 Package b) TC1186-2.5VCT713: 2.5V LDO Regulator, Various Temp., 5LD SOT-23 Package c) TC1186-2.6VCT713: 2.6V LDO Regulator, Various Temp., 5LD SOT-23 Package d) TC1186-2.7VCT713: 2.7V LDO Regulator, Various Temp., 5LD SOT-23 Package e) TC1186-2.8VCT713: 2.8V LDO Regulator, Various Temp., 5LD SOT-23 Package f) TC1186-2.85VCT713: 2.85V LDO Regulator, Various Temp., 5LD SOT-23 Package g) TC1186-3.0VCT713: 3.0V LDO Regulator, Various Temp., 5LD SOT-23 Package h) TC1186-3.3VCT713: 3.3V LDO Regulator, Various Temp., 5LD SOT-23 Package i) TC1186-3.6VCT713: 3.6V LDO Regulator, Various Temp., 5LD SOT-23 Package j) TC1186-4.0VCT713: 4.0V LDO Regulator, Various Temp., 5LD SOT-23 Package k) TC1186-5.0VCT713: 5.0V LDO Regulator, Various Temp., 5LD SOT-23 Package
Output Voltage *: 1.8 = 1.8V "Standard" 2.5 = 2.5V "Standard" 2.6 = 2.6V "Standard" 2.7 = 2.7V "Standard" 2.8 = 2.8V "Standard" 2.85 = 2.85V "Standard" 3.0 = 3.0V "Standard" 3.3 = 3.3V "Standard" 3.6 = 3.6V "Standard" 4.0 = 4.0V "Standard" 5.0 = 5.0V "Standard" *Contact factory for other output voltage options.					
Temperature Range: V = -40°C to +125°C (Various)					
Package: CT713 = Plastic Small Outline Transistor (SOT-23), Tape and Reel					

TC1054/TC1055/TC1186

NOTES:

Note the following details of the code protection feature on Microchip devices:

- Microchip products meet the specification contained in their particular Microchip Data Sheet.
- Microchip believes that its family of products is one of the most secure families of its kind on the market today, when used in the intended manner and under normal conditions.
- There are dishonest and possibly illegal methods used to breach the code protection feature. All of these methods, to our knowledge, require using the Microchip products in a manner outside the operating specifications contained in Microchip's Data Sheets. Most likely, the person doing so is engaged in theft of intellectual property.
- Microchip is willing to work with the customer who is concerned about the integrity of their code.
- Neither Microchip nor any other semiconductor manufacturer can guarantee the security of their code. Code protection does not mean that we are guaranteeing the product as “unbreakable.”

Code protection is constantly evolving. We at Microchip are committed to continuously improving the code protection features of our products. Attempts to break Microchip's code protection feature may be a violation of the Digital Millennium Copyright Act. If such acts allow unauthorized access to your software or other copyrighted work, you may have a right to sue for relief under that Act.

Information contained in this publication regarding device applications and the like is provided only for your convenience and may be superseded by updates. It is your responsibility to ensure that your application meets with your specifications. MICROCHIP MAKES NO REPRESENTATIONS OR WARRANTIES OF ANY KIND WHETHER EXPRESS OR IMPLIED, WRITTEN OR ORAL, STATUTORY OR OTHERWISE, RELATED TO THE INFORMATION, INCLUDING BUT NOT LIMITED TO ITS CONDITION, QUALITY, PERFORMANCE, MERCHANTABILITY OR FITNESS FOR PURPOSE. Microchip disclaims all liability arising from this information and its use. Use of Microchip devices in life support and/or safety applications is entirely at the buyer's risk, and the buyer agrees to defend, indemnify and hold harmless Microchip from any and all damages, claims, suits, or expenses resulting from such use. No licenses are conveyed, implicitly or otherwise, under any Microchip intellectual property rights.

Trademarks

The Microchip name and logo, the Microchip logo, dsPIC, FlashFlex, KEELOQ, KEELOQ logo, MPLAB, PIC, PICmicro, PICSTART, PIC³² logo, rPIC, SST, SST Logo, SuperFlash and UNI/O are registered trademarks of Microchip Technology Incorporated in the U.S.A. and other countries.

FilterLab, Hampshire, HI-TECH C, Linear Active Thermistor, MTP, SEEVAL and The Embedded Control Solutions Company are registered trademarks of Microchip Technology Incorporated in the U.S.A.

Silicon Storage Technology is a registered trademark of Microchip Technology Inc. in other countries.

Analog-for-the-Digital Age, Application Maestro, BodyCom, chipKIT, chipKIT logo, CodeGuard, dsPICDEM, dsPICDEM.net, dsPICworks, dsSPEAK, ECAN, ECONOMONITOR, FanSense, HI-TIDE, In-Circuit Serial Programming, ICSP, Mindi, MiWi, MPASM, MPF, MPLAB Certified logo, MPLIB, MPLINK, mTouch, Omniclient Code Generation, PICC, PICC-18, PICDEM, PICDEM.net, PICkit, PICTail, REAL ICE, rLAB, Select Mode, SQI, Serial Quad I/O, Total Endurance, TSHARC, UniWinDriver, WiperLock, ZENA and Z-Scale are trademarks of Microchip Technology Incorporated in the U.S.A. and other countries.

SQTP is a service mark of Microchip Technology Incorporated in the U.S.A.

GestIC and ULPP are registered trademarks of Microchip Technology Germany II GmbH & Co. & KG, a subsidiary of Microchip Technology Inc., in other countries.

All other trademarks mentioned herein are property of their respective companies.

© 2002-2012, Microchip Technology Incorporated, Printed in the U.S.A., All Rights Reserved.

 Printed on recycled paper.

ISBN: 978-1-62076-721-4

QUALITY MANAGEMENT SYSTEM
CERTIFIED BY DNV
== ISO/TS 16949 ==

Microchip received ISO/TS-16949:2009 certification for its worldwide headquarters, design and wafer fabrication facilities in Chandler and Tempe, Arizona; Gresham, Oregon and design centers in California and India. The Company's quality system processes and procedures are for its PIC[®] MCUs and dsPIC[®] DSCs, KEELOQ[®] code hopping devices, Serial EEPROMs, microperipherals, nonvolatile memory and analog products. In addition, Microchip's quality system for the design and manufacture of development systems is ISO 9001:2000 certified.



MICROCHIP

Worldwide Sales and Service

AMERICAS

Corporate Office
2355 West Chandler Blvd.
Chandler, AZ 85224-6199
Tel: 480-792-7200
Fax: 480-792-7277
Technical Support:
<http://www.microchip.com/support>
Web Address:
www.microchip.com

Atlanta
Duluth, GA
Tel: 678-957-9614
Fax: 678-957-1455

Boston
Westborough, MA
Tel: 774-760-0087
Fax: 774-760-0088

Chicago
Itasca, IL
Tel: 630-285-0071
Fax: 630-285-0075

Cleveland
Independence, OH
Tel: 216-447-0464
Fax: 216-447-0643

Dallas
Addison, TX
Tel: 972-818-7423
Fax: 972-818-2924

Detroit
Farmington Hills, MI
Tel: 248-538-2250
Fax: 248-538-2260

Indianapolis
Noblesville, IN
Tel: 317-773-8323
Fax: 317-773-5453

Los Angeles
Mission Viejo, CA
Tel: 949-462-9523
Fax: 949-462-9608

Santa Clara
Santa Clara, CA
Tel: 408-961-6444
Fax: 408-961-6445

Toronto
Mississauga, Ontario,
Canada
Tel: 905-673-0699
Fax: 905-673-6509

ASIA/PACIFIC

Asia Pacific Office
Suites 3707-14, 37th Floor
Tower 6, The Gateway
Harbour City, Kowloon
Hong Kong
Tel: 852-2401-1200
Fax: 852-2401-3431

Australia - Sydney
Tel: 61-2-9868-6733
Fax: 61-2-9868-6755

China - Beijing
Tel: 86-10-8569-7000
Fax: 86-10-8528-2104

China - Chengdu
Tel: 86-28-8665-5511
Fax: 86-28-8665-7889

China - Chongqing
Tel: 86-23-8980-9588
Fax: 86-23-8980-9500

China - Hangzhou
Tel: 86-571-2819-3187
Fax: 86-571-2819-3189

China - Hong Kong SAR
Tel: 852-2943-5100
Fax: 852-2401-3431

China - Nanjing
Tel: 86-25-8473-2460
Fax: 86-25-8473-2470

China - Qingdao
Tel: 86-532-8502-7355
Fax: 86-532-8502-7205

China - Shanghai
Tel: 86-21-5407-5533
Fax: 86-21-5407-5066

China - Shenyang
Tel: 86-24-2334-2829
Fax: 86-24-2334-2393

China - Shenzhen
Tel: 86-755-8864-2200
Fax: 86-755-8203-1760

China - Wuhan
Tel: 86-27-5980-5300
Fax: 86-27-5980-5118

China - Xian
Tel: 86-29-8833-7252
Fax: 86-29-8833-7256

China - Xiamen
Tel: 86-592-2388138
Fax: 86-592-2388130

China - Zhuhai
Tel: 86-756-3210040
Fax: 86-756-3210049

ASIA/PACIFIC

India - Bangalore
Tel: 91-80-3090-4444
Fax: 91-80-3090-4123

India - New Delhi
Tel: 91-11-4160-8631
Fax: 91-11-4160-8632

India - Pune
Tel: 91-20-2566-1512
Fax: 91-20-2566-1513

Japan - Osaka
Tel: 81-6-6152-7160
Fax: 81-6-6152-9310

Japan - Tokyo
Tel: 81-3-6880-3770
Fax: 81-3-6880-3771

Korea - Daegu
Tel: 82-53-744-4301
Fax: 82-53-744-4302

Korea - Seoul
Tel: 82-2-554-7200
Fax: 82-2-558-5932 or
82-2-558-5934

Malaysia - Kuala Lumpur
Tel: 60-3-6201-9857
Fax: 60-3-6201-9859

Malaysia - Penang
Tel: 60-4-227-8870
Fax: 60-4-227-4068

Philippines - Manila
Tel: 63-2-634-9065
Fax: 63-2-634-9069

Singapore
Tel: 65-6334-8870
Fax: 65-6334-8850

Taiwan - Hsin Chu
Tel: 886-3-5778-366
Fax: 886-3-5770-955

Taiwan - Kaohsiung
Tel: 886-7-213-7828
Fax: 886-7-330-9305

Taiwan - Taipei
Tel: 886-2-2508-8600
Fax: 886-2-2508-0102

Thailand - Bangkok
Tel: 66-2-694-1351
Fax: 66-2-694-1350

EUROPE

Austria - Wels
Tel: 43-7242-2244-39
Fax: 43-7242-2244-393

Denmark - Copenhagen
Tel: 45-4450-2828
Fax: 45-4485-2829

France - Paris
Tel: 33-1-69-53-63-20
Fax: 33-1-69-30-90-79

Germany - Munich
Tel: 49-89-627-144-0
Fax: 49-89-627-144-44

Italy - Milan
Tel: 39-0331-742611
Fax: 39-0331-466781

Netherlands - Drunen
Tel: 31-416-690399
Fax: 31-416-690340

Spain - Madrid
Tel: 34-91-708-08-90
Fax: 34-91-708-08-91

UK - Wokingham
Tel: 44-118-921-5869
Fax: 44-118-921-5820

11/29/12



Компания «ЭлектроПласт» предлагает заключение долгосрочных отношений при поставках импортных электронных компонентов на взаимовыгодных условиях!

Наши преимущества:

- Оперативные поставки широкого спектра электронных компонентов отечественного и импортного производства напрямую от производителей и с крупнейших мировых складов;
- Поставка более 17-ти миллионов наименований электронных компонентов;
- Поставка сложных, дефицитных, либо снятых с производства позиций;
- Оперативные сроки поставки под заказ (от 5 рабочих дней);
- Экспресс доставка в любую точку России;
- Техническая поддержка проекта, помощь в подборе аналогов, поставка прототипов;
- Система менеджмента качества сертифицирована по Международному стандарту ISO 9001;
- Лицензия ФСБ на осуществление работ с использованием сведений, составляющих государственную тайну;
- Поставка специализированных компонентов (Xilinx, Altera, Analog Devices, Intersil, Interpoint, Microsemi, Aeroflex, Peregrine, Syfer, Eurofarad, Texas Instrument, Miteq, Cobham, E2V, MA-COM, Hittite, Mini-Circuits, General Dynamics и др.);

Помимо этого, одним из направлений компании «ЭлектроПласт» является направление «Источники питания». Мы предлагаем Вам помощь Конструкторского отдела:

- Подбор оптимального решения, техническое обоснование при выборе компонента;
- Подбор аналогов;
- Консультации по применению компонента;
- Поставка образцов и прототипов;
- Техническая поддержка проекта;
- Защита от снятия компонента с производства.



Как с нами связаться

Телефон: 8 (812) 309 58 32 (многоканальный)

Факс: 8 (812) 320-02-42

Электронная почта: org@eplast1.ru

Адрес: 198099, г. Санкт-Петербург, ул. Калинина, дом 2, корпус 4, литера А.