

MC74AC14, MC74ACT14

Hex Inverter Schmitt Trigger

The MC74AC14/74ACT14 contains six logic inverters which accept standard CMOS Input signals (TTL levels for MC74ACT14) and provide standard CMOS output levels. They are capable of transforming slowly changing input signals into sharply defined, jitter-free output signals. In addition, they have a greater noise margin than conventional inverters.

The MC74AC14/74ACT14 has hysteresis between the positive-going and negative-going input thresholds (typically 1.0 V) which is determined internally by transistor ratios and is essentially insensitive to temperature and supply voltage variations.

Features

- Schmitt Trigger Inputs
- Outputs Source/Sink 24 mA
- MC74ACT14 Has TTL Compatible Inputs
- Pb-Free Packages are Available

MAXIMUM RATINGS

| Rating | Symbol | Value | Unit |
|---|-----------|------------------------|-------------|
| DC Supply Voltage (Referenced to GND) | V_{CC} | -0.5 to +7.0 | V |
| DC Input Voltage (Referenced to GND) | V_{in} | -0.5 to $V_{CC} + 0.5$ | V |
| DC Output Voltage (Referenced to GND) | V_{out} | -0.5 to $V_{CC} + 0.5$ | V |
| DC Input Current, per Pin | I_{in} | ± 20 | mA |
| DC Output Sink/Source Current, per Pin | I_{out} | ± 50 | mA |
| DC V_{CC} or GND Current per Output Pin | I_{CC} | ± 50 | $^{\circ}C$ |
| Storage Temperature | T_{stg} | -65 to +150 | mJ |

Stresses exceeding Maximum Ratings may damage the device. Maximum Ratings are stress ratings only. Functional operation above the Recommended Operating Conditions is not implied. Extended exposure to stresses above the Recommended Operating Conditions may affect device reliability.



ON Semiconductor®

<http://onsemi.com>

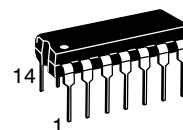

PDIP-14
SUFFIX N
CASE 646

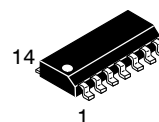

SOIC-14
SUFFIX D
CASE 751A

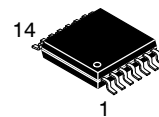

TSSOP-14
SUFFIX DT
CASE 948G

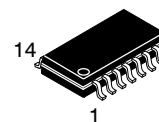

SOEIAJ-14
SUFFIX M
CASE 965

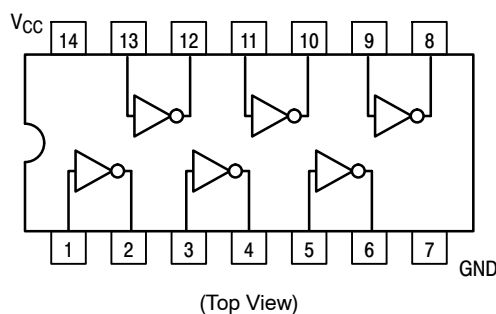

Figure 1. Pinout: 14-Lead Packages Conductors

FUNCTION TABLE

| Input | Output |
|-------|--------|
| A | O |
| L | H |
| H | L |

ORDERING INFORMATION

See detailed ordering and shipping information in the package dimensions section on page 4 of this data sheet.

DEVICE MARKING INFORMATION

See general marking information in the device marking section on page 4 of this data sheet.

MC74AC14, MC74ACT14

RECOMMENDED OPERATING CONDITIONS

| Symbol | Parameter | Min | Typ | Max | Unit | |
|------------------------------------|---|-------------------------|-----|-----------------|------|------|
| V _{CC} | Supply Voltage | 'AC | 2.0 | 5.0 | 6.0 | V |
| | | 'ACT | 4.5 | 5.0 | 5.5 | |
| V _{in} , V _{out} | DC Input Voltage, Output Voltage (Ref. to GND) | 0 | – | V _{CC} | V | |
| t _r , t _f | Input Rise and Fall Time (Note 1) 'AC Devices except Schmitt Inputs | V _{CC} @ 3.0 V | – | 150 | – | ns/V |
| | | V _{CC} @ 4.5 V | – | 40 | – | |
| | | V _{CC} @ 5.5 V | – | 25 | – | |
| t _r , t _f | Input Rise and Fall Time (Note 2) 'ACT Devices except Schmitt Inputs | V _{CC} @ 4.5 V | – | 10 | – | ns/V |
| | | V _{CC} @ 5.5 V | – | 8.0 | – | |
| T _J | Junction Temperature (PDIP) | – | – | 140 | °C | |
| T _A | Operating Ambient Temperature Range | –40 | 25 | 85 | °C | |
| I _{OH} | Output Current – High | – | – | –24 | mA | |
| I _{OL} | Output Current – Low | – | – | 24 | mA | |

- V_{in} from 30% to 70% V_{CC}; see individual Data Sheets for devices that differ from the typical input rise and fall times.
- V_{in} from 0.8 V to 2.0 V; see individual Data Sheets for devices that differ from the typical input rise and fall times.

DC CHARACTERISTICS

| Symbol | Parameter | V _{CC} (V) | 74AC | | 74AC | | Unit | Conditions |
|------------------|-----------------------------------|------------------------|------------------------|-------------------|---------------------------------|--|------|---|
| | | | T _A = +25°C | | T _A = –40°C to +85°C | | | |
| | | | Typ | Guaranteed Limits | | | | |
| V _{OH} | Minimum High Level Output Voltage | 3.0 | 2.99 | 2.9 | 2.9 | | V | I _{OUT} = –50 μA |
| | | 4.5 | 4.49 | 4.4 | 4.4 | | | |
| | | 5.5 | 5.49 | 5.4 | 5.4 | | | |
| | | 3.0 | – | 2.56 | 2.46 | | V | *V _{IN} = V _{IL} or V _{IH} –12 mA I _{OH} –24 mA –24 mA |
| | | 4.5 | – | 3.86 | 3.76 | | | |
| | | 5.5 | – | 4.86 | 4.76 | | | |
| V _{OL} | Maximum Low Level Output Voltage | 3.0 | 0.002 | 0.1 | 0.1 | | V | I _{OUT} = 50 μA |
| | | 4.5 | 0.001 | 0.1 | 0.1 | | | |
| | | 5.5 | 0.001 | 0.1 | 0.1 | | | |
| | | 3.0 | – | 0.36 | 0.44 | | V | *V _{IN} = V _{IL} or V _{IH} 12 mA I _{OL} 24 mA 24 mA |
| | | 4.5 | – | 0.36 | 0.44 | | | |
| | | 5.5 | – | 0.36 | 0.44 | | | |
| I _{IN} | Maximum Input Leakage Current | 5.5 | – | ±0.1 | ±1.0 | | μA | V _I = V _{CC} , GND |
| I _{OLD} | †Minimum Dynamic Output Current | 5.5 | – | – | 75 | | mA | V _{OLD} = 1.65 V Max |
| I _{OHD} | | 5.5 | – | – | –75 | | mA | V _{OHD} = 3.85 V Min |
| I _{CC} | Maximum Quiescent Supply Current | 5.5 | – | 4.0 | 40 | | μA | V _{IN} = V _{CC} or GND |

*All outputs loaded; thresholds on input associated with output under test.

†Maximum test duration 2.0 ms, one output loaded at a time.

NOTE: I_{IN} and I_{CC} @ 3.0 V are guaranteed to be less than or equal to the respective limit @ 5.5 V V_{CC}.

AC CHARACTERISTICS (For Figures and Waveforms – See Section 3 of the ON Semiconductor FACT Data Book, DL138/D)

| Symbol | Parameter | V _{CC} * (V) | 74AC | | | 74AC | | Unit | Figure No. |
|------------------|-------------------|--------------------------|---|-----|------|--|------|------|------------|
| | | | T _A = +25°C C _L = 50 pF | | | T _A = –40°C to +85°C C _L = 50 pF | | | |
| | | | Min | Typ | Max | Min | Max | | |
| t _{pLH} | Propagation Delay | 3.3 | 1.5 | 9.5 | 13.5 | 1.5 | 15.0 | ns | 3–5 |
| | | 5.0 | 1.5 | 7.0 | 10.0 | 1.5 | 11.0 | | |
| t _{pHL} | Propagation Delay | 3.3 | 1.5 | 7.5 | 11.5 | 1.5 | 13.0 | ns | 3–5 |
| | | 5.0 | 1.5 | 6.0 | 8.5 | 1.5 | 9.5 | | |

*Voltage Range 3.3 V is 3.3 V ±0.3 V. Voltage Range 5.0 V is 5.0 V ±0.5 V.

MC74AC14, MC74ACT14

INPUT CHARACTERISTICS (unless otherwise specified)

| Symbol | Parameter | V _{CC} (V) | 74AC | | 74ACT | | Test Conditions |
|---------------------|----------------------------|---------------------|------|-----|-------|---|-----------------------------|
| | | | | | | | |
| V _{t+} | Maximum Positive Threshold | 3.0 | 2.2 | - | - | V | T _A = Worst Case |
| | | 4.5 | 3.2 | 2.0 | | | |
| | | 5.5 | 3.9 | 2.0 | | | |
| V _{t-} | Minimum Negative Threshold | 3.0 | 0.5 | - | - | V | T _A = Worst Case |
| | | 4.5 | 0.9 | 0.8 | | | |
| | | 5.5 | 1.1 | 0.8 | | | |
| V _{h(max)} | Maximum Hysteresis | 3.0 | 1.2 | - | - | V | T _A = Worst Case |
| | | 4.5 | 1.4 | 1.2 | | | |
| | | 5.5 | 1.6 | 1.2 | | | |
| V _{h(min)} | Minimum Hysteresis | 3.0 | 0.3 | - | - | V | T _A = Worst Case |
| | | 4.5 | 0.4 | 0.4 | | | |
| | | 5.5 | 0.5 | 0.4 | | | |

DC CHARACTERISTICS

| Symbol | Parameter | V _{CC} (V) | 74ACT | | 74ACT | | Unit | Conditions |
|-------------------|--|---------------------|------------------------|-------------------|---------------------------------|----|--|------------|
| | | | T _A = +25°C | | T _A = -40°C to +85°C | | | |
| | | | Typ | Guaranteed Limits | | | | |
| V _{OH} | Minimum High Level Output Voltage | 4.5 | 4.49 | 4.4 | 4.4 | V | I _{OUT} = -50 μA | |
| | | 5.5 | 5.49 | 5.4 | 5.4 | | | |
| | | 4.5 | - | 3.86 | 3.76 | | | V |
| 5.5 | - | 4.86 | 4.76 | | | | | |
| V _{OL} | Maximum Low Level Output Voltage | 4.5 | 0.001 | 0.1 | 0.1 | V | I _{OUT} = 50 μA | |
| | | 5.5 | 0.001 | 0.1 | 0.1 | | | |
| | | 4.5 | - | 0.36 | 0.44 | | | V |
| 5.5 | - | 0.36 | 0.44 | | | | | |
| I _{IN} | Maximum Input Leakage Current | 5.5 | - | ±0.1 | ±1.0 | μA | V _I = V _{CC} , GND | |
| ΔI _{CCT} | Additional Max. I _{CC} /Input | 5.5 | 0.6 | - | 1.5 | mA | V _I = V _{CC} - 2.1 V | |
| I _{OLD} | †Minimum Dynamic Output Current | 5.5 | - | - | 75 | mA | V _{OLD} = 1.65 V Max | |
| I _{OHD} | | 5.5 | - | - | -75 | mA | V _{OHD} = 3.85 V Min | |
| I _{CC} | Maximum Quiescent Supply Current | 5.5 | - | 4.0 | 40 | μA | V _{IN} = V _{CC} or GND | |

*All outputs loaded; thresholds on input associated with output under test.

†Maximum test duration 2.0 ms, one output loaded at a time.

AC CHARACTERISTICS (For Figures and Waveforms - See Section 3 of the ON Semiconductor FACT Data Book, DL138/D)

| Symbol | Parameter | V _{CC} * (V) | 74ACT | | | 74ACT | | Unit | Figure No. |
|------------------|-------------------|-----------------------|---|-----|------|--|------|------|------------|
| | | | T _A = +25°C C _L = 50 pF | | | T _A = -40°C to +85°C C _L = 50 pF | | | |
| | | | Min | Typ | Max | Min | Max | | |
| t _{PLH} | Propagation Delay | 5.0 | 1.5 | - | 11.5 | 1.0 | 12.5 | ns | 3-5 |
| t _{PHL} | Propagation Delay | 5.0 | 1.5 | - | 10.0 | 1.0 | 11.0 | ns | 3-5 |

*Voltage Range 5.0 V is 5.0 V ±0.5 V.

CAPACITANCE

| Symbol | Parameter | Value Typ | Unit | Test Conditions |
|-----------------|-------------------------------|-----------|------|-------------------------|
| C _{IN} | Input Capacitance | 4.5 | pF | V _{CC} = 5.0 V |
| C _{PD} | Power Dissipation Capacitance | 25 | pF | V _{CC} = 5.0 V |

MC74AC14, MC74ACT14

ORDERING INFORMATION

| Device | Package | Shipping† |
|----------------|------------------------|--------------------|
| MC74AC14NG | PDIP-14 (Pb-Free) | 25 Units / Rail |
| MC74ACT14NG | PDIP-14 (Pb-Free) | |
| MC74AC14D | SOIC-14 | 55 Units / Rail |
| MC74AC14DG | SOIC-14 (Pb-Free) | |
| MC74AC14DR2G | SOIC-14 (Pb-Free) | 2500 / Tape & Reel |
| MC74ACT14DG | SOIC-14 (Pb-Free) | 55 Units / Rail |
| MC74ACT14DR2 | SOIC-14 | 2500 / Tape & Reel |
| MC74ACT14DR2G | SOIC-14 (Pb-Free) | |
| MC74AC14DTR2 | TSSOP-14* | |
| MC74AC14DTR2G | TSSOP-14* | |
| MC74ACT14DTR2 | TSSOP-14* | |
| MC74ACT14DTR2G | TSSOP-14* | |
| MC74AC14MEL | SOEIAJ-14 | 2000 / Tape & Reel |
| MC74AC14MELG | SOEIAJ-14 (Pb-Free) | |
| MC74ACT14MELG | SOEIAJ-14 (Pb-Free) | |

†For information on tape and reel specifications, including part orientation and tape sizes, please refer to our Tape and Reel Packaging Specifications Brochure, BRD8011/D.

*This package is inherently Pb-Free.

MARKING DIAGRAMS

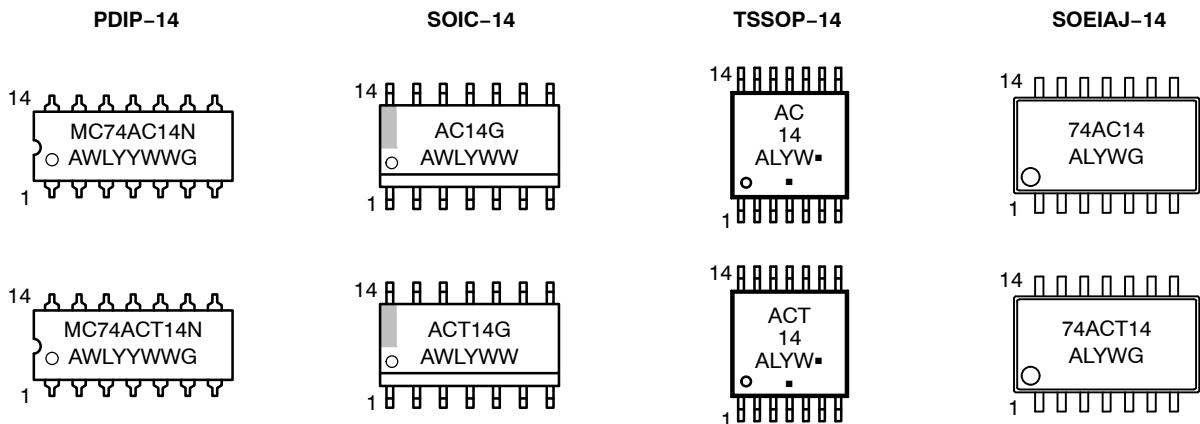

A = Assembly Location
 WL, L = Wafer Lot
 YY, Y = Year
 WW, W = Work Week
 G or ■ = Pb-Free Package
 (Note: Microdot may be in either location)

MC74AC14, MC74ACT14

PACKAGE DIMENSIONS

PDIP-14
CASE 646-06
ISSUE P

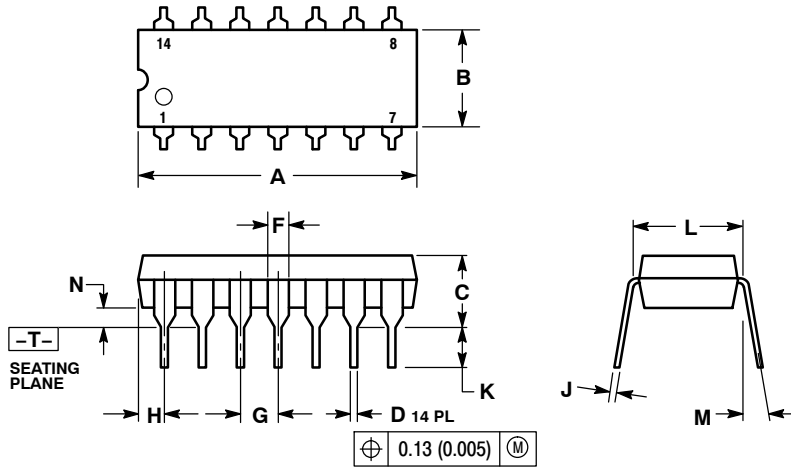

NOTES:

1. DIMENSIONING AND TOLERANCING PER ANSI Y14.5M, 1982.
2. CONTROLLING DIMENSION: INCH.
3. DIMENSION L TO CENTER OF LEADS WHEN FORMED PARALLEL.
4. DIMENSION B DOES NOT INCLUDE MOLD FLASH.
5. ROUNDED CORNERS OPTIONAL.

| DIM | INCHES | | MILLIMETERS | |
|-----|-----------|-------|-------------|-------|
| | MIN | MAX | MIN | MAX |
| A | 0.715 | 0.770 | 18.16 | 19.56 |
| B | 0.240 | 0.260 | 6.10 | 6.60 |
| C | 0.145 | 0.185 | 3.69 | 4.69 |
| D | 0.015 | 0.021 | 0.38 | 0.53 |
| F | 0.040 | 0.070 | 1.02 | 1.78 |
| G | 0.100 BSC | | 2.54 BSC | |
| H | 0.052 | 0.095 | 1.32 | 2.41 |
| J | 0.008 | 0.015 | 0.20 | 0.38 |
| K | 0.115 | 0.135 | 2.92 | 3.43 |
| L | 0.290 | 0.310 | 7.37 | 7.87 |
| M | --- | 10° | --- | 10° |
| N | 0.015 | 0.039 | 0.38 | 1.01 |

MC74AC14, MC74ACT14

PACKAGE DIMENSIONS

SOIC-14 NB
CASE 751A-03
ISSUE K

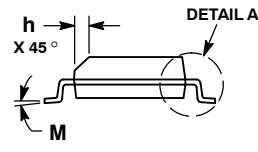
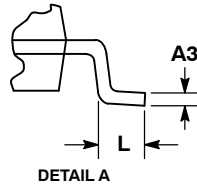
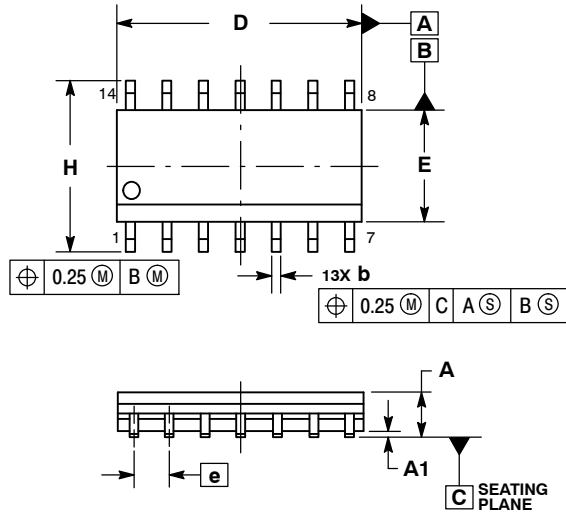

NOTES:

1. DIMENSIONING AND TOLERANCING PER ASME Y14.5M, 1994.
2. CONTROLLING DIMENSION: MILLIMETERS.
3. DIMENSION b DOES NOT INCLUDE DAMBAR PROTRUSION. ALLOWABLE PROTRUSION SHALL BE 0.13 TOTAL IN EXCESS OF AT MAXIMUM MATERIAL CONDITION.
4. DIMENSIONS D AND E DO NOT INCLUDE MOLD PROTRUSIONS.
5. MAXIMUM MOLD PROTRUSION 0.15 PER SIDE.

| DIM | MILLIMETERS | | INCHES | |
|-----|-------------|------|-----------|-------|
| | MIN | MAX | MIN | MAX |
| A | 1.35 | 1.75 | 0.054 | 0.068 |
| A1 | 0.10 | 0.25 | 0.004 | 0.010 |
| A3 | 0.19 | 0.25 | 0.008 | 0.010 |
| b | 0.35 | 0.49 | 0.014 | 0.019 |
| D | 8.55 | 8.75 | 0.337 | 0.344 |
| E | 3.80 | 4.00 | 0.150 | 0.157 |
| e | 1.27 BSC | | 0.050 BSC | |
| H | 5.80 | 6.20 | 0.228 | 0.244 |
| h | 0.25 | 0.50 | 0.010 | 0.019 |
| L | 0.40 | 1.25 | 0.016 | 0.049 |
| M | 0° | 7° | 0° | 7° |

SOLDERING FOOTPRINT*

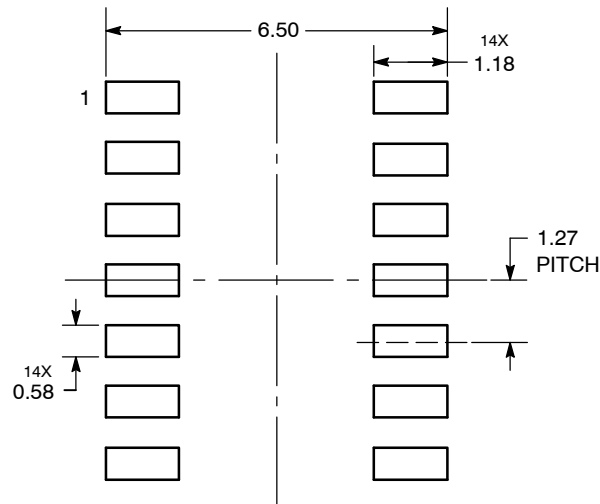

DIMENSIONS: MILLIMETERS

*For additional information on our Pb-Free strategy and soldering details, please download the ON Semiconductor Soldering and Mounting Techniques Reference Manual, SOLDERRM/D.

MC74AC14, MC74ACT14

PACKAGE DIMENSIONS

TSSOP-14 CASE 948G-01 ISSUE B

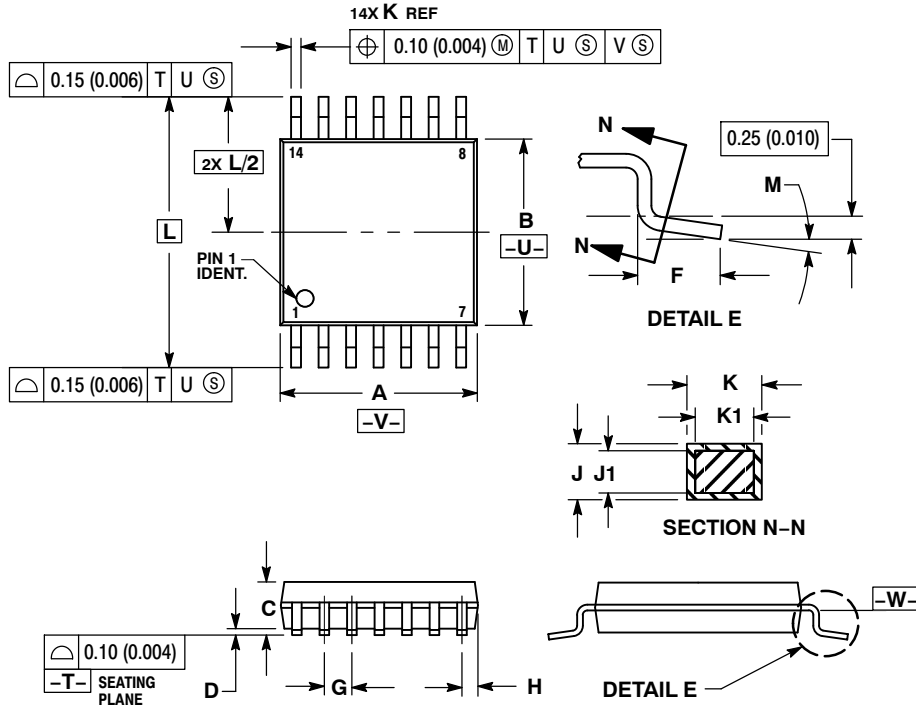

- NOTES:
1. DIMENSIONING AND TOLERANCING PER ANSI Y14.5M, 1982.
 2. CONTROLLING DIMENSION: MILLIMETER.
 3. DIMENSION A DOES NOT INCLUDE MOLD FLASH, PROTRUSIONS OR GATE BURRS. MOLD FLASH OR GATE BURRS SHALL NOT EXCEED 0.15 (0.006) PER SIDE.
 4. DIMENSION B DOES NOT INCLUDE INTERLEAD FLASH OR PROTRUSION. INTERLEAD FLASH OR PROTRUSION SHALL NOT EXCEED 0.25 (0.010) PER SIDE.
 5. DIMENSION K DOES NOT INCLUDE DAMBAR PROTRUSION. ALLOWABLE DAMBAR PROTRUSION SHALL BE 0.08 (0.003) TOTAL IN EXCESS OF THE K DIMENSION AT MAXIMUM MATERIAL CONDITION.
 6. TERMINAL NUMBERS ARE SHOWN FOR REFERENCE ONLY.
 7. DIMENSION A AND B ARE TO BE DETERMINED AT DATUM PLANE -W-.

SOLDERING FOOTPRINT*

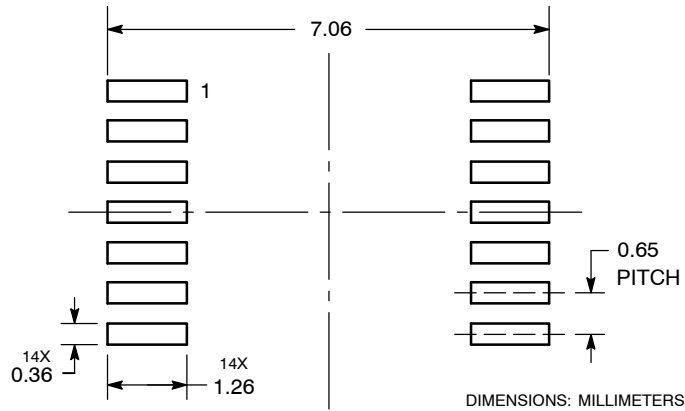

*For additional information on our Pb-Free strategy and soldering details, please download the ON Semiconductor Soldering and Mounting Techniques Reference Manual, SOLDERM/D.

MC74AC14, MC74ACT14

PACKAGE DIMENSIONS

SOEIAJ-14
M SUFFIX
CASE 965-01
ISSUE B

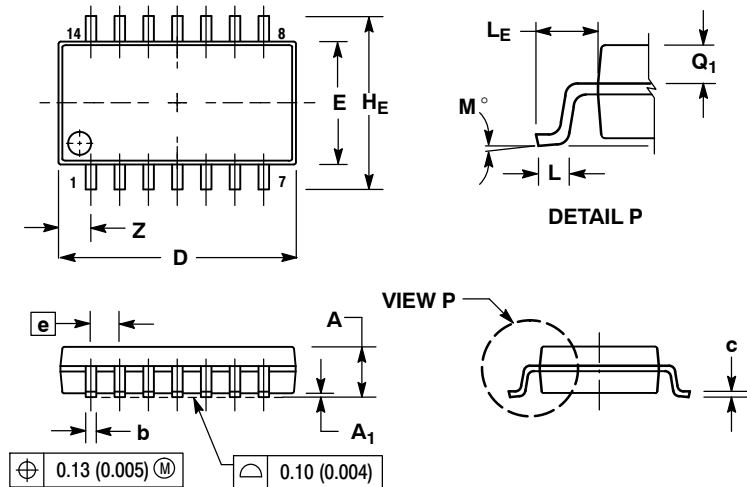

NOTES:

1. DIMENSIONING AND TOLERANCING PER ANSI Y14.5M, 1982.
2. CONTROLLING DIMENSION: MILLIMETER.
3. DIMENSIONS D AND E DO NOT INCLUDE MOLD FLASH OR PROTRUSIONS AND ARE MEASURED AT THE PARTING LINE. MOLD FLASH OR PROTRUSIONS SHALL NOT EXCEED 0.15 (0.006) PER SIDE.
4. TERMINAL NUMBERS ARE SHOWN FOR REFERENCE ONLY.
5. THE LEAD WIDTH DIMENSION (b) DOES NOT INCLUDE DAMBAR PROTRUSION. ALLOWABLE DAMBAR PROTRUSION SHALL BE 0.08 (0.003) TOTAL IN EXCESS OF THE LEAD WIDTH DIMENSION AT MAXIMUM MATERIAL CONDITION. DAMBAR CANNOT BE LOCATED ON THE LOWER RADIUS OR THE FOOT. MINIMUM SPACE BETWEEN PROTRUSIONS AND ADJACENT LEAD TO BE 0.46 (0.018).

| DIM | MILLIMETERS | | INCHES | |
|----------------|-------------|-------|-----------|-------|
| | MIN | MAX | MIN | MAX |
| A | --- | 2.05 | --- | 0.081 |
| A ₁ | 0.05 | 0.20 | 0.002 | 0.008 |
| b | 0.35 | 0.50 | 0.014 | 0.020 |
| c | 0.10 | 0.20 | 0.004 | 0.008 |
| D | 9.90 | 10.50 | 0.390 | 0.413 |
| E | 5.10 | 5.45 | 0.201 | 0.215 |
| e | 1.27 BSC | | 0.050 BSC | |
| H _E | 7.40 | 8.20 | 0.291 | 0.323 |
| L | 0.50 | 0.85 | 0.020 | 0.033 |
| L _E | 1.10 | 1.50 | 0.043 | 0.059 |
| M | 0° | 10° | 0° | 10° |
| Q ₁ | 0.70 | 0.90 | 0.028 | 0.035 |
| Z | --- | 1.42 | --- | 0.056 |

ON Semiconductor and are registered trademarks of Semiconductor Components Industries, LLC (SCILLC). SCILLC reserves the right to make changes without further notice to any products herein. SCILLC makes no warranty, representation or guarantee regarding the suitability of its products for any particular purpose, nor does SCILLC assume any liability arising out of the application or use of any product or circuit, and specifically disclaims any and all liability, including without limitation special, consequential or incidental damages. "Typical" parameters which may be provided in SCILLC data sheets and/or specifications can and do vary in different applications and actual performance may vary over time. All operating parameters, including "Typicals" must be validated for each customer application by customer's technical experts. SCILLC does not convey any license under its patent rights nor the rights of others. SCILLC products are not designed, intended, or authorized for use as components in systems intended for surgical implant into the body, or other applications intended to support or sustain life, or for any other application in which the failure of the SCILLC product could create a situation where personal injury or death may occur. Should Buyer purchase or use SCILLC products for any such unintended or unauthorized application, Buyer shall indemnify and hold SCILLC and its officers, employees, subsidiaries, affiliates, and distributors harmless against all claims, costs, damages, and expenses, and reasonable attorney fees arising out of, directly or indirectly, any claim of personal injury or death associated with such unintended or unauthorized use, even if such claim alleges that SCILLC was negligent regarding the design or manufacture of the part. SCILLC is an Equal Opportunity/Affirmative Action Employer. This literature is subject to all applicable copyright laws and is not for resale in any manner.

PUBLICATION ORDERING INFORMATION

LITERATURE FULFILLMENT:
Literature Distribution Center for ON Semiconductor
P.O. Box 5163, Denver, Colorado 80217 USA
Phone: 303-675-2175 or 800-344-3860 Toll Free USA/Canada
Fax: 303-675-2176 or 800-344-3867 Toll Free USA/Canada
Email: orderlit@onsemi.com

N. American Technical Support: 800-282-9855 Toll Free
USA/Canada
Europe, Middle East and Africa Technical Support:
Phone: 421 33 790 2910
Japan Customer Focus Center
Phone: 81-3-5773-3850

ON Semiconductor Website: www.onsemi.com
Order Literature: <http://www.onsemi.com/orderlit>

For additional information, please contact your local Sales Representative



Компания «ЭлектроПласт» предлагает заключение долгосрочных отношений при поставках импортных электронных компонентов на взаимовыгодных условиях!

Наши преимущества:

- Оперативные поставки широкого спектра электронных компонентов отечественного и импортного производства напрямую от производителей и с крупнейших мировых складов;
- Поставка более 17-ти миллионов наименований электронных компонентов;
- Поставка сложных, дефицитных, либо снятых с производства позиций;
- Оперативные сроки поставки под заказ (от 5 рабочих дней);
- Экспресс доставка в любую точку России;
- Техническая поддержка проекта, помощь в подборе аналогов, поставка прототипов;
- Система менеджмента качества сертифицирована по Международному стандарту ISO 9001;
- Лицензия ФСБ на осуществление работ с использованием сведений, составляющих государственную тайну;
- Поставка специализированных компонентов (Xilinx, Altera, Analog Devices, Intersil, Interpoint, Microsemi, Aeroflex, Peregrine, Syfer, Eurofarad, Texas Instrument, Miteq, Cobham, E2V, MA-COM, Hittite, Mini-Circuits, General Dynamics и др.);

Помимо этого, одним из направлений компании «ЭлектроПласт» является направление «Источники питания». Мы предлагаем Вам помощь Конструкторского отдела:

- Подбор оптимального решения, техническое обоснование при выборе компонента;
- Подбор аналогов;
- Консультации по применению компонента;
- Поставка образцов и прототипов;
- Техническая поддержка проекта;
- Защита от снятия компонента с производства.



Как с нами связаться

Телефон: 8 (812) 309 58 32 (многоканальный)

Факс: 8 (812) 320-02-42

Электронная почта: org@eplast1.ru

Адрес: 198099, г. Санкт-Петербург, ул. Калинина, дом 2, корпус 4, литера А.