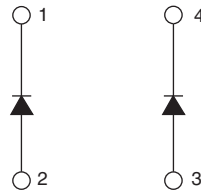

Insulated Ultrafast Rectifier Module, 120 A

SOT-227
FEATURES

- Two fully independent diodes
- Ceramic fully insulated package ($V_{ISOL} = 2500 V_{AC}$)
- Ultrafast reverse recovery
- Ultrasoft reverse recovery current shape
- Low forward voltage
- Optimized for power conversion: welding and industrial SMPS applications
- Industry standard outline
- Plug-in compatible with other SOT-227 packages
- Easy to assemble
- Direct mounting to heatsink
- Totally lead (Pb)-free
- Designed and qualified for industrial level

RoHS
COMPLIANT

DESCRIPTION

The UFB120FA60P insulated modules integrate two state of the art Vishay's ultrafast recovery rectifiers in the compact, industry standard SOT-227 package. The planar structure of the diodes, and the platinum doping life time control, provide an ultrasoft recovery current shape, together with the best overall performance, ruggedness, and reliability characteristics.

These devices are thus intended for high frequency applications in which the switching energy is designed not to be a predominant portion of the total energy, such as in the output rectification stage of welding machines, SMPS, and dc-to-dc converters. Their extremely optimized stored charge and low recovery current reduce both over dissipation in the switching elements (and snubbers) and EMI/RFI.

PRODUCT SUMMARY

V_R	600 V
$I_{F(AV)}$ per module at $T_C = 73\text{ }^\circ\text{C}$	120 A
t_{rr}	79 ns

ABSOLUTE MAXIMUM RATINGS

PARAMETER	SYMBOL	TEST CONDITIONS	MAX.	UNITS
Cathode to anode voltage	V_R		600	V
Continuous forward current per diode	I_F	$T_C = 85\text{ }^\circ\text{C}$	65	A
Single pulse forward current per diode	I_{FSM}	$T_C = 25\text{ }^\circ\text{C}$	700	
Maximum power dissipation per module	P_D	$T_C = 85\text{ }^\circ\text{C}$	180	W
RMS isolation voltage	V_{ISOL}	Any terminal to case, $t = 1\text{ min}$	2500	V
Operating junction and storage temperatures	T_J, T_{Stg}		- 55 to 175	$^\circ\text{C}$



ELECTRICAL SPECIFICATIONS ($T_J = 25\text{ }^\circ\text{C}$ unless otherwise specified)							
PARAMETER	SYMBOL	TEST CONDITIONS	MIN.	TYP.	MAX.	UNITS	
Cathode to anode breakdown voltage	V_{BR}	$I_R = 100\text{ }\mu\text{A}$	600	-	-	V	
Forward voltage	V_{FM}	$I_F = 60\text{ A}$	-	1.43	1.8		
		$I_F = 120\text{ A}$	-	1.66	2.1		
		$I_F = 60\text{ A}$	$T_J = 125\text{ }^\circ\text{C}$	-	1.23		1.48
		$I_F = 120\text{ A}$		-	1.5		1.82
Reverse leakage current	I_{RM}	$V_R = V_R\text{ rated}$	-	0.1	100	μA	
		$T_J = 175\text{ }^\circ\text{C}, V_R = V_R\text{ rated}$	-	0.2	1.0	mA	
Junction capacitance	C_T	$V_R = 600\text{ V}$	-	80	-	pF	

DYNAMIC RECOVERY CHARACTERISTICS ($T_J = 25\text{ }^\circ\text{C}$ unless otherwise specified)							
PARAMETER	SYMBOL	TEST CONDITIONS	MIN.	TYP.	MAX.	UNITS	
Reverse recovery time	t_{rr}	$T_J = 25\text{ }^\circ\text{C}$	-	79	104	ns	
		$T_J = 125\text{ }^\circ\text{C}$	-	164	209		
Peak recovery current	I_{RRM}	$T_J = 25\text{ }^\circ\text{C}$	$I_F = 50\text{ A}$ $di_F/dt = 200\text{ A}/\mu\text{s}$ $V_R = 200\text{ V}$	-	6	9	A
		$T_J = 125\text{ }^\circ\text{C}$		-	15	19	
Reverse recovery charge	Q_{rr}	$T_J = 25\text{ }^\circ\text{C}$		-	231	415	nC
		$T_J = 125\text{ }^\circ\text{C}$		-	1221	1986	

THERMAL - MECHANICAL SPECIFICATIONS						
PARAMETER	SYMBOL	TEST CONDITIONS	MIN.	TYP.	MAX.	UNITS
Junction to case, single leg conducting	R_{thJC}		-	-	1.0	$^\circ\text{C}/\text{W}$
Junction to case, both leg conducting			-	-	0.5	
Case to heatsink	R_{thCS}	Flat, greased surface	-	0.05	-	
Weight			-	30	-	g
Mounting torque			-	1.3	-	$\text{N} \cdot \text{m}$



Insulated Ultrafast Rectifier Module, 120 A

UFB120FA60P

Vishay High Power Products

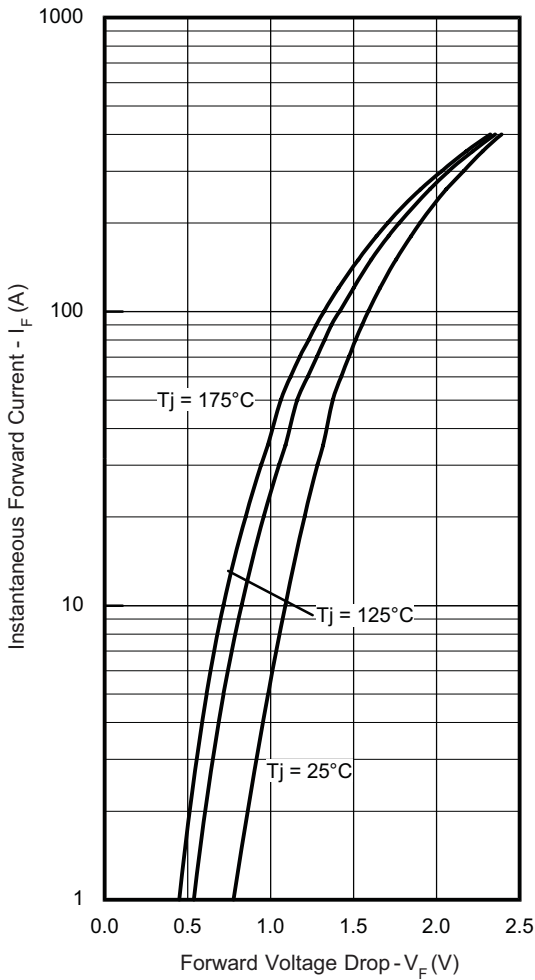

Fig. 1 - Typical Forward Voltage Drop Characteristics (Per Diode)

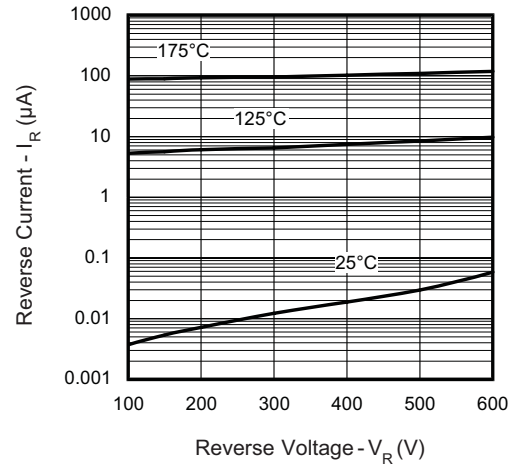

Fig. 2 - Typical Values of Reverse Current vs. Reverse Voltage

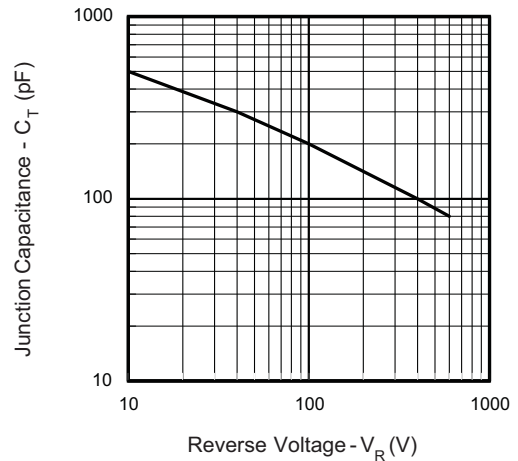

Fig. 3 - Typical Junction Capacitance vs. Reverse Voltage

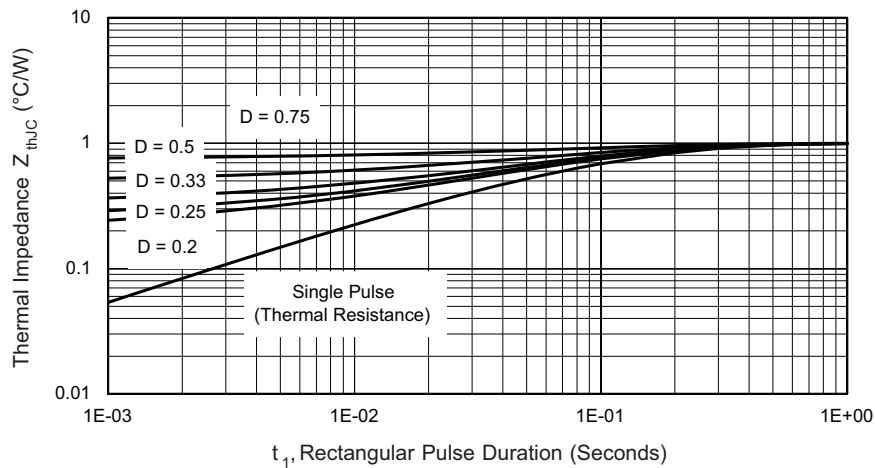

Fig. 4 - Maximum Thermal Impedance Z_{thJC} Characteristics (Per Diode)

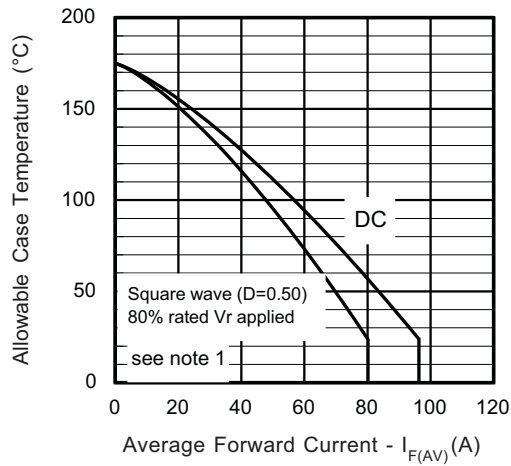

Fig. 5 - Maximum Allowable Case Temperature vs. Average Forward Current (Per Leg)

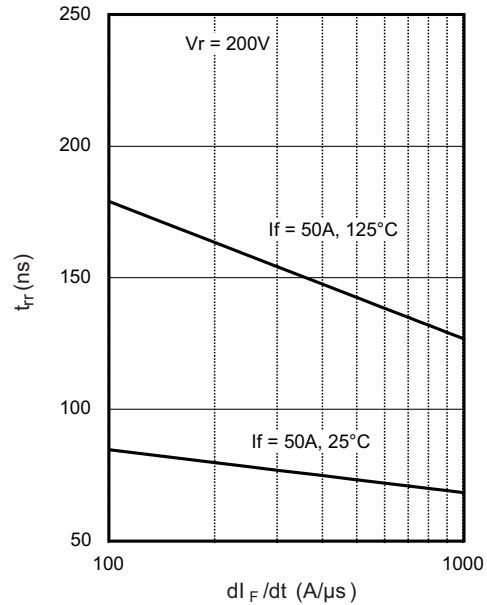

Fig. 7 - Typical Reverse Recovery Time vs. di_F/dt

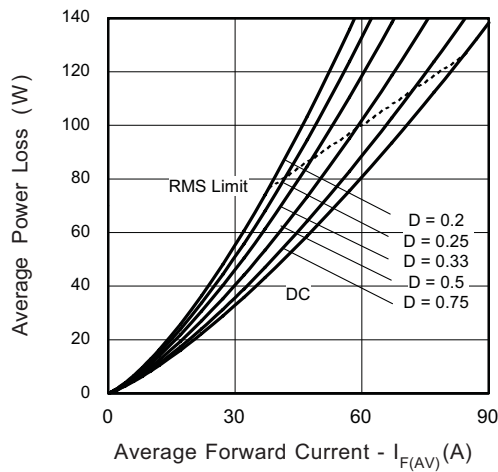

Fig. 6 - Forward Power Loss Characteristics (Per Leg)

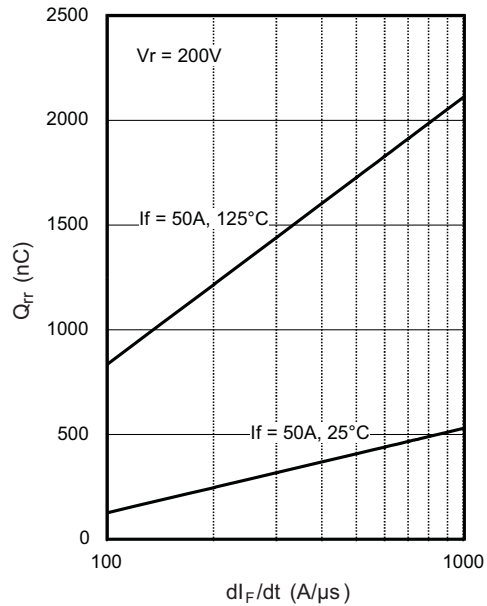

Fig. 8 - Typical Stored Charge vs. di_F/dt

Note

(1) Formula used: $T_C = T_J - (Pd + Pd_{REV}) \times R_{thJC}$;
 Pd = Forward power loss = $I_{F(AV)} \times V_{FM}$ at $(I_{F(AV)}/D)$ (see fig. 6);
 Pd_{REV} = Inverse power loss = $V_{R1} \times I_R (1 - D)$; I_R at $V_{R1} = 80\%$ rated V_R

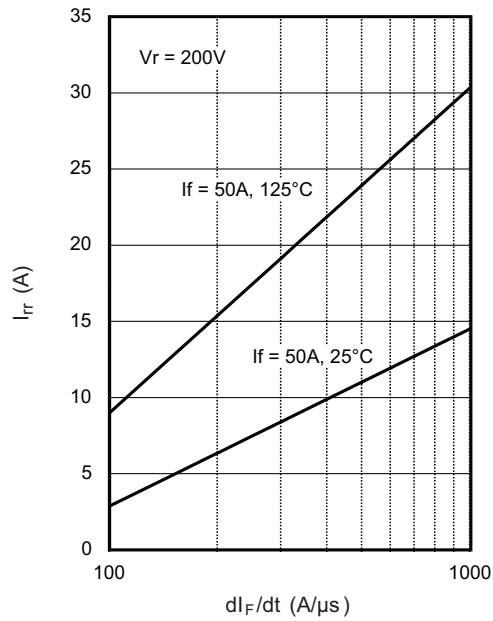
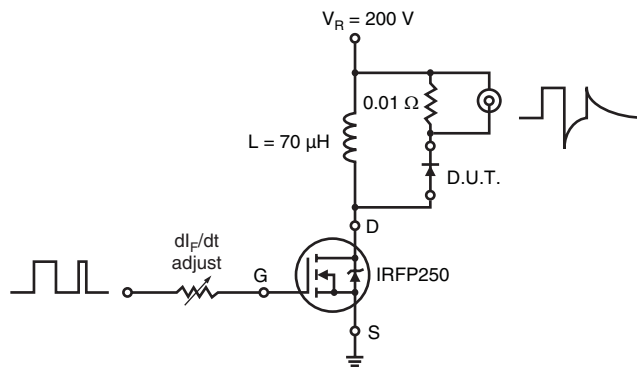

 Fig. 9 - Typical Stored Current vs. di_F/dt

Fig. 10 - Reverse Recovery Parameter Test Circuit

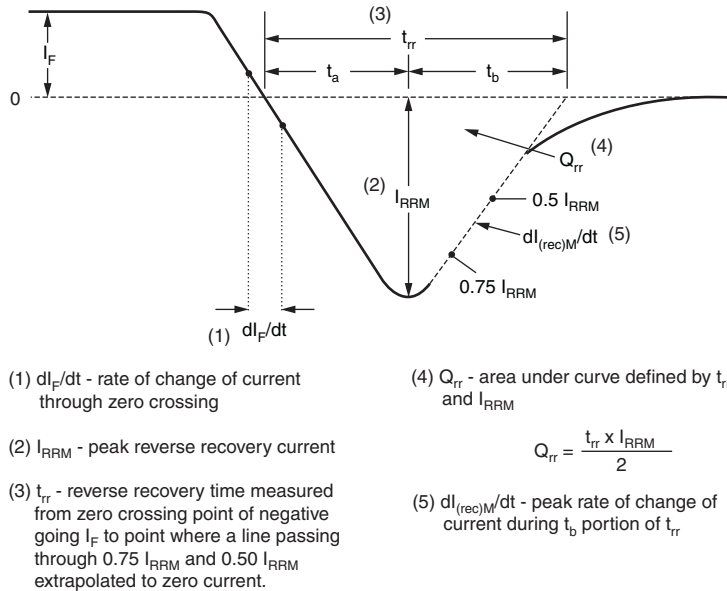

Fig. 11 - Reverse Recovery Waveform and Definitions

ORDERING INFORMATION TABLE

Device code	UF	B	120	F	A	60	P
	①	②	③	④	⑤	⑥	⑦
	1	-	Ultrafast rectifier				
	2	-	Ultrafast Pt diffused				
	3	-	Current rating (120 = 120 A)				
	4	-	Circuit configuration (2 separate diodes, parallel pin-out)				
	5	-	Package indicator (SOT-227 standard isolated base)				
	6	-	Voltage rating (60 = 600 V)				
	7	-	P = Lead (Pb)-free				

LINKS TO RELATED DOCUMENTS	
Dimensions	http://www.vishay.com/doc?95036
Packaging information	http://www.vishay.com/doc?95037



Disclaimer

All product specifications and data are subject to change without notice.

Vishay Intertechnology, Inc., its affiliates, agents, and employees, and all persons acting on its or their behalf (collectively, "Vishay"), disclaim any and all liability for any errors, inaccuracies or incompleteness contained herein or in any other disclosure relating to any product.

Vishay disclaims any and all liability arising out of the use or application of any product described herein or of any information provided herein to the maximum extent permitted by law. The product specifications do not expand or otherwise modify Vishay's terms and conditions of purchase, including but not limited to the warranty expressed therein, which apply to these products.

No license, express or implied, by estoppel or otherwise, to any intellectual property rights is granted by this document or by any conduct of Vishay.

The products shown herein are not designed for use in medical, life-saving, or life-sustaining applications unless otherwise expressly indicated. Customers using or selling Vishay products not expressly indicated for use in such applications do so entirely at their own risk and agree to fully indemnify Vishay for any damages arising or resulting from such use or sale. Please contact authorized Vishay personnel to obtain written terms and conditions regarding products designed for such applications.

Product names and markings noted herein may be trademarks of their respective owners.



Компания «ЭлектроПласт» предлагает заключение долгосрочных отношений при поставках импортных электронных компонентов на взаимовыгодных условиях!

Наши преимущества:

- Оперативные поставки широкого спектра электронных компонентов отечественного и импортного производства напрямую от производителей и с крупнейших мировых складов;
- Поставка более 17-ти миллионов наименований электронных компонентов;
- Поставка сложных, дефицитных, либо снятых с производства позиций;
- Оперативные сроки поставки под заказ (от 5 рабочих дней);
- Экспресс доставка в любую точку России;
- Техническая поддержка проекта, помощь в подборе аналогов, поставка прототипов;
- Система менеджмента качества сертифицирована по Международному стандарту ISO 9001;
- Лицензия ФСБ на осуществление работ с использованием сведений, составляющих государственную тайну;
- Поставка специализированных компонентов (Xilinx, Altera, Analog Devices, Intersil, Interpoint, Microsemi, Aeroflex, Peregrine, Syfer, Eurofarad, Texas Instrument, Miteq, Cobham, E2V, MA-COM, Hittite, Mini-Circuits, General Dynamics и др.);

Помимо этого, одним из направлений компании «ЭлектроПласт» является направление «Источники питания». Мы предлагаем Вам помощь Конструкторского отдела:

- Подбор оптимального решения, техническое обоснование при выборе компонента;
- Подбор аналогов;
- Консультации по применению компонента;
- Поставка образцов и прототипов;
- Техническая поддержка проекта;
- Защита от снятия компонента с производства.



Как с нами связаться

Телефон: 8 (812) 309 58 32 (многоканальный)

Факс: 8 (812) 320-02-42

Электронная почта: org@eplast1.ru

Адрес: 198099, г. Санкт-Петербург, ул. Калинина, дом 2, корпус 4, литера А.