

Typical unit



FEATURES

- Wide range input voltages 9-36 and 18-75 Vdc
- 1" x 1" x 0.41" Dimensions.
- Adjustable Vout (+10% to -10%)
- High Efficiency
- Positive & Negative logic, Remote On/Off control Option
- Monotonic startup
- Continuous Short Circuit protection
- Over-temperature protection
- Over-Voltage protection
- Low output ripple and noise
- Strong thermal derating characteristics
- Operational Temperature Range -40°C to +85°C
- 1600V I/O isolation
- Packaged in a five-sided EMI shielding metal package with non-conductive base
- Certified to UL 60950-1, CAN/CSA-C22.2 No. 60950-1, IEC60950-1, safety approvals, 2nd edition, with AM1

PRODUCT OVERVIEW

The SPM15 series isolated DC-DC converters represent the next generation in Industrial Potted Module Technology. Featuring a full 15-Watt output in one square inch of board area, the SPM15 series isolated DC-DC converter family offers efficient regulated DC power for printed circuit board mounting. The 1" x 1" x 0.41" (25.4 x 25.4 x 10.41 mm) converter accepts a wide range of input voltages, ideal for industrial applications.

Intended target markets include transportation, medical systems, electronic test equipment, industrial processing equipment, industrial applications where power modules must meet rugged environmental requirements, high power density, and where isolated output voltages are required. These

converters offer a feature/option set including: through-hole mounting, positive or negative logic (remote on/off), over-current & over-temperature protection, under-voltage lockout. The input voltage range covers the standard Industrial requirements with a regulated output voltage and power rating up to 15W.

Modules provide voltage isolation (basic insulation) from input to output of up to 1600V. The Operating Ambient Temperature Range is -40°C to +85°C. The Module delivers full output power to +70°C with no airflow. These parts are ideal for applications that do not require any heat sinking or forced air cooling.



PERFORMANCE SPECIFICATIONS SUMMARY AND ORDERING GUIDE ① ③															
Root Models ①	Output					Input				Efficiency (%)		Dimensions			
	V _{OUT} (V)	I _{OUT} (A, max)	Total Power (W)	R/N (mVp-p)		Regulation (Max.)		V _{IN} Nom. (V)	Range (V)	I _{IN} , min. load (mA)	I _{IN} , full load (A)	Min.	Typ.	Case (inches)	Case (mm)
				Typ. ②	Max.	Line	Load								
SPM15-033-Q12	3.3	4.5	14.85	60	100	±0.25	±0.25	24	9-36	100	0.695	86.5	89	1.0 x 1.0 x 0.41	25.4 x 25.4 x 10.41
SPM15-033-Q48	3.3	5	16.5	30	60	±0.25	±0.25	48	18-75	60	0.76	88.5	90	1.0 x 1.0 x 0.41	25.4 x 25.4 x 10.41
SPM15-050-Q12	5	3	15	40	70	±0.05%	±0.1%	24	9-36	105	0.71	85.5	88	1.0 x 1.0 x 0.41	25.4 x 25.4 x 10.41
SPM15-050-Q48	5	3	15	60	95	±0.3%	±0.2%	48	18-75	56	0.35	86.5	88.5	1.0 x 1.0 x 0.41	25.4 x 25.4 x 10.41
SPM15-120-Q12	12	1.3	15.6	60	120	±0.05%	±0.1%	24	9-36	110	0.77	82.3	84	1.0 x 1.0 x 0.41	25.4 x 25.4 x 10.41
SPM15-120-Q48	12	1.3	15.6	85	120	±0.075%	±0.05%	48	18-75	56	0.76	82	84	1.0 x 1.0 x 0.41	25.4 x 25.4 x 10.41
SPM15-150-Q12	15	1.1	16.5	130	175	±0.1%	±0.1%	24	9-36	130	0.82	82.5	84	1.0 x 1.0 x 0.41	25.4 x 25.4 x 10.41
SPM15-150-Q48	15	1.1	16.5	80	150	±0.1%	±0.075%	48	18-75	60	0.41	83	84.5	1.0 x 1.0 x 0.41	25.4 x 25.4 x 10.41

- Notes:**
- ① Please refer to the part number structure for additional options and complete ordering part numbers.
 - ② Ripple and Noise is shown at 20 MHz bandwidth.
 - ③ All specifications are at nominal line voltage and full load, +25 °C, unless otherwise noted. See detailed specifications for full conditions.

INPUT/OUTPUT EXTERNAL TEST CAPACITORS		
Model	Input Capacitor (electrolytic)	Output Capacitor(s)
SPM15-033-Q12	100 µF	1µF ceramic & 10µF tantalum
SPM15-033-Q48	4.7 µF	
SPM15-050-Q12	100 µF	
SPM15-050-Q48	4.7 µF	
SPM15-120-Q12	100 µF	
SPM15-120-Q48	4.7 µF	
SPM15-150-Q12	100 µF	
SPM15-150-Q48	4.7 µF	

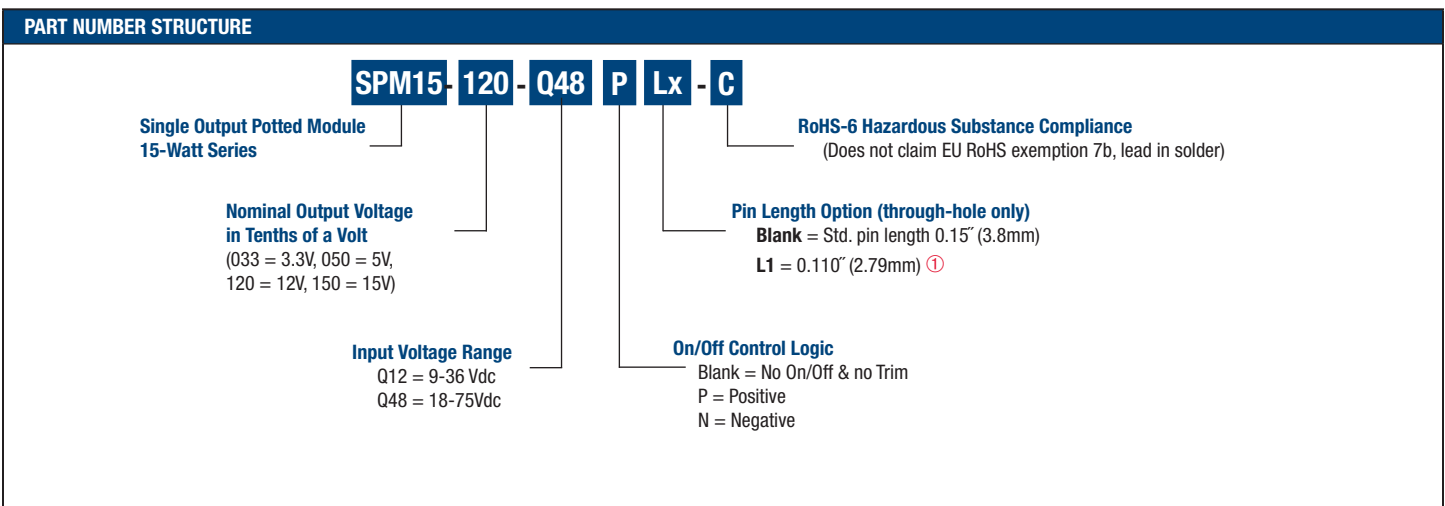

- ① Special quantity order is required; samples available with standard pin length only.
- ② Some model number combinations may not be available. See website or contact your local Murata sales representative.

FUNCTIONAL SPECIFICATIONS – MODEL SPM15-033-Q12

ABSOLUTE MAXIMUM RATINGS	Conditions ①	Minimum	Typical/Nominal	Maximum	Units
Input Voltage, Continuous		0		36	Vdc
Input Voltage, Transient	100 mS max. duration			50	Vdc
Isolation Voltage	Input to output			1600	Vdc
On/Off Remote Control	Power on, referred to -Vin	0		15	Vdc
Output Power		1.46		15.07	W
Output Current	Current-limited, no damage, short-circuit protected	0.45		4.5	A
Storage Temperature Range	Vin = Zero (no power)	-55		125	°C
Absolute maximums are stress ratings. Exposure of devices to greater than any of these conditions may adversely affect long-term reliability. Proper operation under conditions other than those listed in the Performance/Functional Specifications Table is not implied or recommended.					
INPUT					
Operating Voltage Range		9	24	36	Vdc
Recommended External Fuse	Fast blow			4	A
Start-up Threshold	Rising input voltage	8	8.5	9	Vdc
Undervoltage Shutdown (50% load)	Falling input voltage	7.7	8.3	8.9	Vdc
Internal Filter Type			C		
Input Current					
Full Load Input Current	Vin = nominal		0.695	0.726	A
Low Line Input Current	Vin = minimum		1.89	1.947	A
Inrush Transient			0.05		A2-Sec.
Short Circuit Input Current			50	100	A
Minimum Load Input Current	Iout = minimum, unit=ON		100	125	mA
Shut-Down Input Current (Off, UV, OT)			1	2	mA
Reflected (Back) Ripple Current ②	Measured at input with specified filter		30	50	mA, p-p
GENERAL and SAFETY					
Efficiency	Vin = 24V, full load	86.5	89		%
	Vin = min., full load	86	87.3		%
Isolation					
Isolation Voltage	Input to output			1600	Vdc
Isolation Resistance			10		MΩ
Isolation Capacitance			1500		pF
Safety	Certified to UL-60950-1, CSA-C22.2 No. 60950-1, IEC/60950-1, 2nd edition, with AM1		Yes		
Calculated MTBF	Per Telcordia SR332, issue 1, class 3, ground fixed, Tambient = +25°C		2		Hours x 10 ⁶
DYNAMIC CHARACTERISTICS					
Fixed Switching Frequency		325	350	375	KHz
Startup Time	Power on to Vout regulated			50	mS
Startup Time	Remote ON to Vout regulated			50	mS
Dynamic Load Response	50-75-50% load step, settling time to within 1% of Vout		60	100	μSec
Dynamic Load Peak Deviation	same as above		±75	±150	mV
FEATURES and OPTIONS					
Remote On/Off Control ③					
"N" suffix					
Negative Logic, ON state	ON = Ground pin	-0.7		0.8	V
Negative Logic, OFF state	OFF = Pin open	10		15	V
Control Current	Open collector/drain		1		mA
"P" suffix					
Positive Logic, ON state	ON = Pin open	10		15	V
Positive Logic, OFF state	OFF = Ground pin	-0.7		0.7	V
Control Current	Open collector/drain		1		mA

FUNCTIONAL SPECIFICATIONS (CONT.) – MODEL SPM15-033-Q12

OUTPUT	Conditions ① ③	Minimum	Typical/Nominal	Maximum	Units
Total Output Power		1.46	14.85	15.07	W
Voltage					
Nominal Output Voltage	No trim	3.251	3.3	3.35	Vdc
Setting Accuracy	At 50% load, no trim	-1.5		1.5	% of Vnom
Output Voltage Range	User-adjustable	-10		10	% of Vnom
Overvoltage Protection	Via magnetic feedback	3.7	4.9	5.4	Vdc
Current					
Output Current Range		0.45	4.5	4.5	A
Current Limit Inception	98% of Vnom., after warmup	4.9	7.5	8.5	A
Short Circuit					
Short Circuit Current	Hiccup technique, autorecovery within $\pm 1.25\%$ of Vout		0.321		A
Short Circuit Duration (remove short for recovery)	Output shorted to ground, no damage		Continuous		
Short circuit protection method	Current limiting				
Regulation					
Line Regulation	Vin = min. to max., Vout = nom., Iout = nom.			± 0.25	% of Vout
Load Regulation	Iout = min. to max., Vin = 24V			± 0.25	% of Vout
Ripple and Noise	5 Hz- 20 MHz BW, Vin=24V		60	90	mV pk-pk
Maximum Capacitive Loading	Low ESR			1000	μ F
MECHANICAL					
Outline Dimensions			1 x 1 x 0.41		Inches
(Please refer to outline drawing)	WxLxH		25.4 x 25.4 x 10.41		mm
Weight			0.69		Ounces
			19.56		Grams
Through Hole Pin Diameter			0.04		Inches
			1.016		mm
Through Hole Pin Material			Copper alloy		
TH Pin Plating Metal and Thickness	Nickel subplate		50		μ -inches
	Gold overplate		5		μ -inches
ENVIRONMENTAL					
Operating Ambient Temperature Range	See derating	-40		85	$^{\circ}$ C
Operating Case Temperature Range	No derating	-40		85	$^{\circ}$ C
Case Material	Tin plated steel with black powder coat				
Storage Temperature	Vin = Zero (no power)	-55		125	$^{\circ}$ C
Thermal Protection/Shutdown	Measured in center	110	115	120	$^{\circ}$ C
Electromagnetic Interference	External filter is required				
Conducted, EN55022/CISPR22			B		Class
RoHS rating			RoHS-6		

Notes

- ① Unless otherwise noted, all specifications are at nominal input voltage, nominal output voltage and full load. General conditions are +25 $^{\circ}$ Celsius ambient temperature, near sea level altitude, natural convection airflow. All models are tested and specified with external parallel 1 μ F and 10 μ F output capacitors. The external input capacitor is 100 μ F, electrolytic. All capacitors are low-ESR types wired close to the converter.
- ② Input (back) ripple current is tested and specified over 5 Hz to 20 MHz bandwidth. Input filtering is Cbus=220 μ F, Cin=33 μ F and Lbus=12 μ H.
- ③ The Remote On/Off Control is referred to -Vin.

TYPICAL PERFORMANCE DATA, SPM15-033-Q12

Efficiency vs. Line Voltage and Load Current @ 25°C

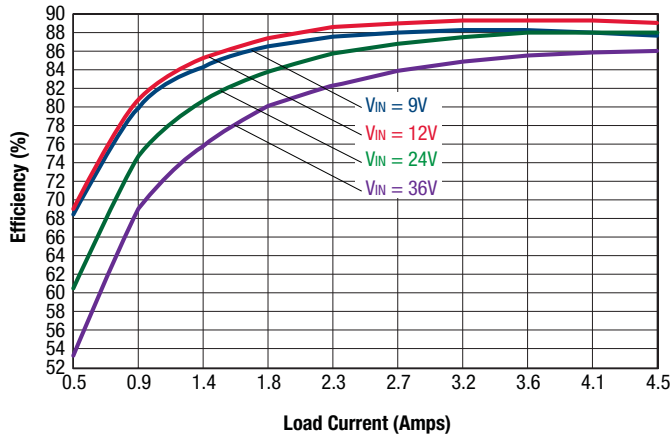

Power Dissipation

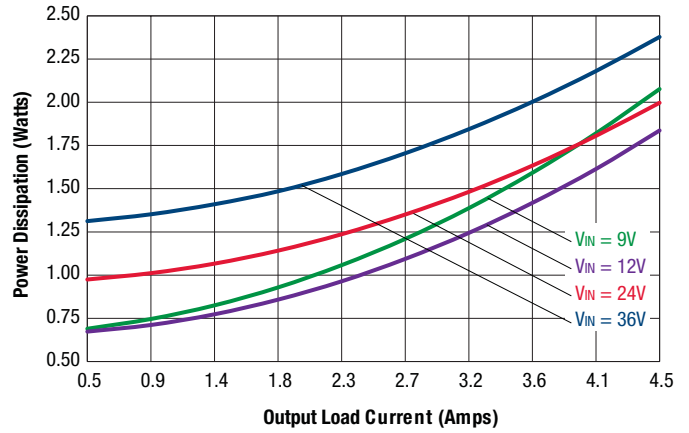

Maximum Current Temperature Derating at sea level
VIN = 9V, 12V, or 24V (air flow from Pin J1 to Pin J2 on PCB)

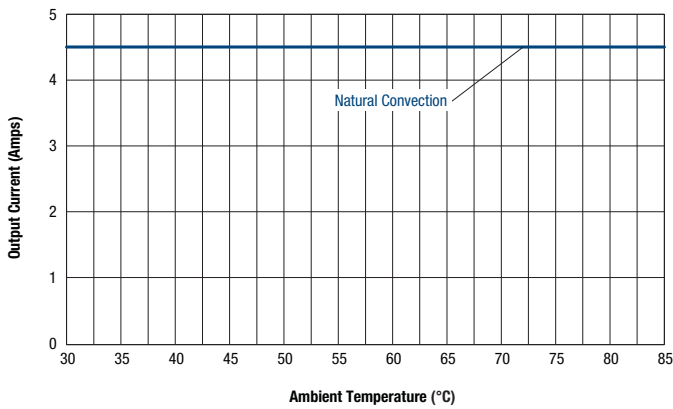

Maximum Current Temperature Derating at sea level
VIN = 36V (air flow from Pin J1 to Pin J2 on PCB)

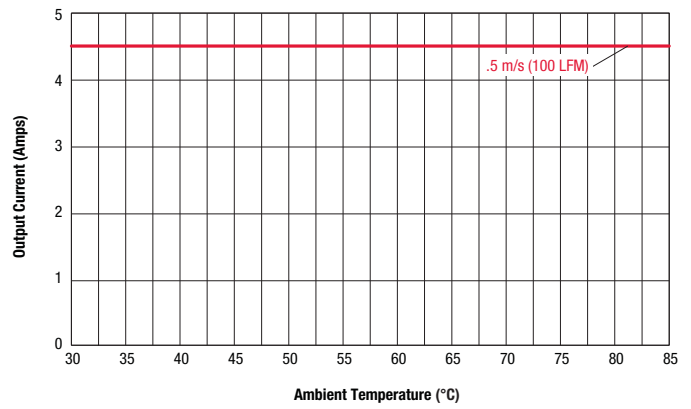

FUNCTIONAL SPECIFICATIONS – MODEL SPM15-033-Q48

ABSOLUTE MAXIMUM RATINGS	Conditions ①	Minimum	Typical/Nominal	Maximum	Units
Input Voltage, Continuous		0		80	Vdc
Input Voltage, Transient	100 mS max. duration			100	Vdc
Isolation Voltage	Input to output			1600	Vdc
On/Off Remote Control	Power on, referred to -Vin	0		15	Vdc
Output Power		1.63		16.75	W
Output Current	Current-limited, no damage, short-circuit protected	0.5		5	A
Storage Temperature Range	Vin = Zero (no power)	-55		125	°C
Absolute maximums are stress ratings. Exposure of devices to greater than any of these conditions may adversely affect long-term reliability. Proper operation under conditions other than those listed in the Performance/Functional Specifications Table is not implied or recommended.					
INPUT					
Operating Voltage Range		18	48	75	Vdc
Recommended External Fuse	Fast blow			2	A
Start-up Threshold	Rising input voltage	15.5	16.9	17.9	Vdc
Undervoltage Shutdown (50% load)	Falling input voltage	15	16	16.8	Vdc
Internal Filter Type			C		
Input Current					
Full Load Input Current	Vin = 24V		0.764	0.788	A
Full Load Input Current	Vin = 48V		0.388	0.403	A
Low Line Input Current	Vin = minimum		1.03	1.04	A
Inrush Transient			0.05		A2-Sec.
Short Circuit Input Current			0.05	0.1	A
Minimum Load Input Current	Iout = minimum, unit=ON		60	90	mA
Shut-Down Input Current (Off, UV, OT)			1	2	mA
Reflected (Back) Ripple Current ②	Measured at input with specified filter		30		mA, p-p
GENERAL and SAFETY					
Efficiency	Vin = 24V, full load	88.5	90		%
	Vin = 48V, full load	86.5	88.5		%
Isolation					
Isolation Voltage	Input to output			1600	Vdc
Isolation Resistance			10		MΩ
Isolation Capacitance			1500		pF
Safety	Certified to UL-60950-1, CSA-C22.2 No. 60950-1, IEC/60950-1, 2nd edition, with AM1		Yes		
Calculated MTBF	Per Telcordia SR332, issue 1, class 3, ground fixed, Tambient = +25°C		2,000,000		Hours
DYNAMIC CHARACTERISTICS					
Fixed Switching Frequency		325	350	375	KHz
Startup Time	Power on to Vout regulated		10	50	mS
Startup Time	Remote ON to Vout regulated		10	50	mS
Dynamic Load Response	50-75-50% load step, settling time to within 1% of Vout		75	150	µSec
Dynamic Load Peak Deviation	same as above		±75	±125	mV
FEATURES and OPTIONS					
Remote On/Off Control ③					
"N" suffix					
Negative Logic, ON state	ON = Ground pin	-0.7		0.8	V
Negative Logic, OFF state	OFF = Pin open	10		15	V
Control Current	Open collector/drain		1		mA
"P" suffix					
Positive Logic, ON state	ON = Pin open	10		15	V
Positive Logic, OFF state	OFF = Ground pin	-0.7		0.7	V
Control Current	Open collector/drain		1		mA

FUNCTIONAL SPECIFICATIONS (CONT.) – MODEL SPM15-033-Q48

OUTPUT	Conditions ① ③	Minimum	Typical/Nominal	Maximum	Units
Total Output Power		1.63	16.5	16.75	W
Voltage					
Nominal Output Voltage	No trim	3.2505	3.3	3.3495	Vdc
Setting Accuracy	At 50% load, no trim		1.5		% of Vnom
Output Voltage Range	User-adjustable	-10		10	% of Vnom
Overvoltage Protection	Via magnetic feedback	4	5	5.6	Vdc
Current					
Output Current Range		0.5	5	5	A
Current Limit Inception	98% of Vnom., after warmup	5.9	7.3	8.4	A
Short Circuit					
Short Circuit Current	Hiccup technique, autorecovery within ±1.25% of Vout			0.3	A
Short Circuit Duration (remove short for recovery)	Output shorted to ground, no damage		Continuous		
Short circuit protection method	Current limiting				
Regulation					
Line Regulation	Vin = min. to max., Vout = nom., Iout = nom.			±0.25	% of Vout
Load Regulation	Iout = min. to max., Vin = 48V			±0.25	% of Vout
Ripple and Noise	20 MHz BW, Vin = 48V		30	60	mV pk-pk
Temperature Coefficient	At all outputs		0.02		% of Vnom./°C
Maximum Capacitive Loading	Low ESR			5000	µF
MECHANICAL					
Outline Dimensions			1 x 1 x 0.41		Inches
(Please refer to outline drawing)	WxLxH		25.4 x 25.4 x 10.41		mm
Weight			0.69		Ounces
			19.56		Grams
Through Hole Pin Diameter			0.04		Inches
			1.016		mm
Through Hole Pin Material			Copper alloy		
TH Pin Plating Metal and Thickness	Nickel subplate		50		µ-inches
	Gold overplate		5		µ-inches
ENVIRONMENTAL					
Operating Ambient Temperature Range	See derating	-40		85	°C
Case Material	Tin plated steel with black powder coat				
Storage Temperature	Vin = Zero (no power)	-55		125	°C
Thermal Protection/Shutdown	Measured in center	120	130	140	°C
Electromagnetic Interference	External filter is required				
Conducted, EN55022/CISPR22			B		Class
RoHS rating			RoHS-6		

Notes

- ① Unless otherwise noted, all specifications are at nominal input voltage, nominal output voltage and full load. General conditions are +25° Celsius ambient temperature, near sea level altitude, natural convection airflow. All models are tested and specified with external parallel 1 µF and 10 µF output capacitors. The external input capacitor is 100 µF, electrolytic. All capacitors are low-ESR types wired close to the converter.
- ② Input (back) ripple current is tested and specified over 5 Hz to 20 MHz bandwidth. Input filtering is Cbus=220 µF, Cin=33 µF and Lbus=12 µH.
- ③ The Remote On/Off Control is referred to -Vin.

TYPICAL PERFORMANCE DATA, SPM15-033-Q48

Efficiency vs. Line Voltage and Load Current @ 25°C

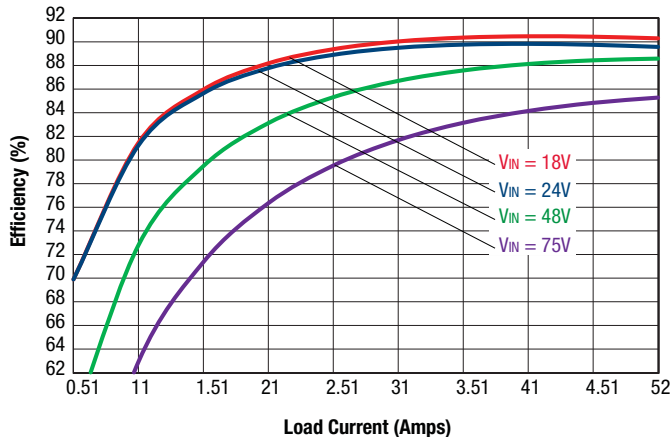

Power Dissipation

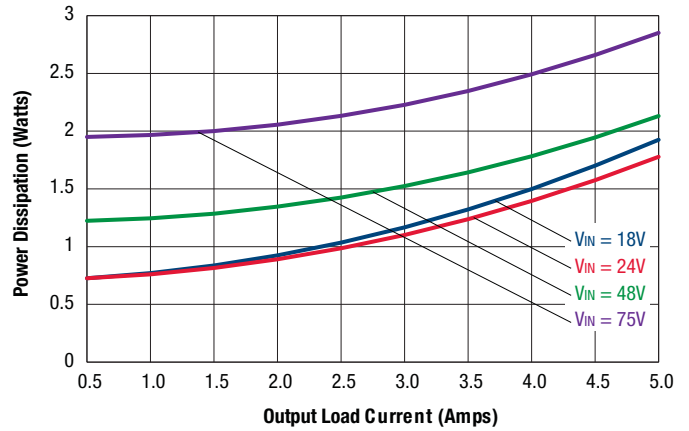

Maximum Current Temperature Derating at sea level
Vin = 18V, 24V, 36V, 48V, or 60V (air flow from Pin J1 to Pin J3 on PCB)

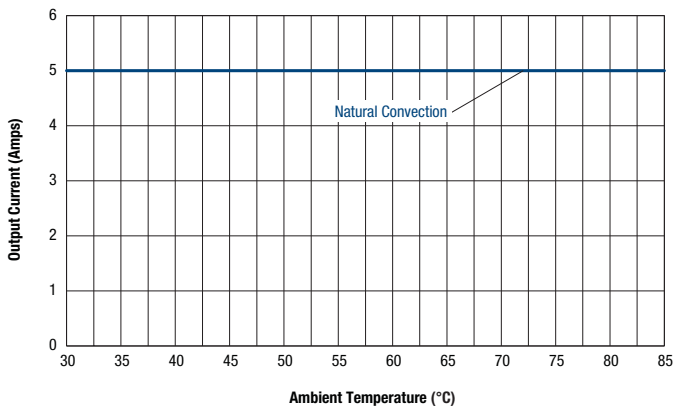

Maximum Current Temperature Derating at sea level
Vin 75 (air flow from Pin J1 to Pin J3 on PCB)

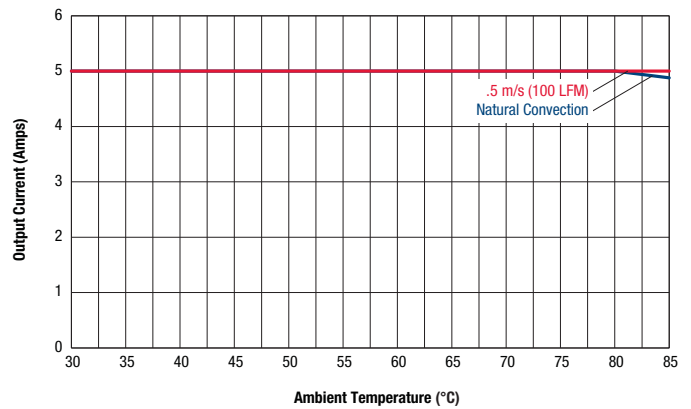

FUNCTIONAL SPECIFICATIONS – MODEL SPM15-050-Q12

ABSOLUTE MAXIMUM RATINGS	Conditions ①	Minimum	Typical/Nominal	Maximum	Units
Input Voltage, Continuous		0		36	Vdc
Input Voltage, Transient	100 mS max. duration			50	Vdc
Isolation Voltage	Input to output			1600	Vdc
On/Off Remote Control	Power on, referred to -Vin	0		15	Vdc
Output Power		1.48		15.23	W
Output Current	Current-limited, no damage, short-circuit protected	0.30		3	A
Storage Temperature Range	Vin = Zero (no power)	-55		125	°C
Absolute maximums are stress ratings. Exposure of devices to greater than any of these conditions may adversely affect long-term reliability. Proper operation under conditions other than those listed in the Performance/Functional Specifications Table is not implied or recommended.					
INPUT					
Operating Voltage Range		9	24	36	Vdc
Recommended External Fuse	Fast blow			4	A
Start-up Threshold	Rising input voltage	8	8.6	9	Vdc
Start up Threshold	@-40°C	9.5	10.0	10.5	Vdc
Undervoltage Shutdown	Falling input voltage	7.8	8.25	9	Vdc
Internal Filter Type			C		
Input Current					
Full Load Input Current	Vin = nominal		0.71	0.73	A
Low Line Input Current	Vin = minimum		1.91	1.97	A
Inrush Transient			0.05		A ² -Sec.
Short Circuit Input Current			50	100	mA
Minimum Load Input Current	Iout = minimum, unit=ON		105	135	mA
Shut-Down Input Current (Off, UV, OT)			1	2	mA
Reflected (Back) Ripple Current ②	Measured at input with specified filter		30		mA, p-p
GENERAL and SAFETY					
Efficiency	Vin = 24V, full load	85.5	88		%
	Vin = min., full load	86	87.3		%
Isolation					
Isolation Voltage	Input to output	1600			Vdc
Isolation Resistance			10		MΩ
Isolation Capacitance			1500		pF
Safety	Certified to UL-60950-1, CSA-C22.2 No. 60950-1, IEC/60950-1, 2nd edition, with AM1		Yes		
Calculated MTBF	Per Telcordia SR332, issue 1, class 3, ground fixed, Tambient = +25°C		6.2		Hours x 10 ⁶
DYNAMIC CHARACTERISTICS					
Fixed Switching Frequency		330	350	370	KHz
Startup Time	Power on to Vout regulated			50	mS
Startup Time	Remote ON to Vout regulated			50	mS
Dynamic Load Response	50-75-50% load step, settling time to within 1% of Vout		100	150	μSec
Dynamic Load Peak Deviation	same as above		±85	±125	mV
FEATURES and OPTIONS					
Remote On/Off Control ③					
"N" suffix					
Negative Logic, ON state	ON = Ground pin	-0.7		0.8	V
Negative Logic, OFF state	OFF = Pin open	10		15	V
Control Current	Open collector/drain		1		mA
"P" suffix					
Positive Logic, ON state	ON = Pin open	10		15	V
Positive Logic, OFF state	OFF = Ground pin	-0.7		0.7	V
Control Current	Open collector/drain		1		mA

FUNCTIONAL SPECIFICATIONS (CONT.) – MODEL SPM15-050-Q12

OUTPUT	Conditions ① ③	Minimum	Typical/Nominal	Maximum	Units
Total Output Power		1.48	15	15.23	W
Voltage					
Nominal Output Voltage	No trim	4.925	5	5.075	Vdc
Setting Accuracy	At 50% load, no trim	-1.5		1.5	% of Vnom
Output Voltage Range	User-adjustable	-10		10	% of Vnom.
Overvoltage Protection	Via magnetic feedback	5.75	5.9	7	Vdc
Current					
Output Current Range		0.3	3	3	A
Current Limit Inception	98% of Vnom., after warmup	3.5	4.75	6.5	A
Short Circuit					
Short Circuit Current	Hiccup technique, autorecovery within $\pm 1.25\%$ of Vout			0.3	A
Short Circuit Duration (remove short for recovery)	Output shorted to ground, no damage		Continuous		
Short circuit protection method	Current limiting				
Regulation					
Line Regulation	Vin = min. to max., Vout = nom., Iout = nom.			± 0.05	% of Vout
Load Regulation	Iout = min. to max., Vin = 24V			± 0.1	% of Vout
Ripple and Noise	5 Hz- 20 MHz BW, Vin=24V		40	70	mV pk-pk
Temperature Coefficient	At all outputs		± 0.02		% of Vnom./°C
Maximum Capacitive Loading	Low ESR			1000	μF
MECHANICAL					
Outline Dimensions			1 x 1 x 0.41		Inches
(Please refer to outline drawing)	WxLxH		25.4 x 25.4 x 10.41		mm
Weight			0.69		Ounces
			19.56		Grams
Through Hole Pin Diameter			0.04		Inches
			1.016		mm
Through Hole Pin Material			Copper alloy		
TH Pin Plating Metal and Thickness	Nickel subplate		50		$\mu\text{-inches}$
	Gold overplate		5		$\mu\text{-inches}$
ENVIRONMENTAL					
Operating Ambient Temperature Range	See derating	-40		85	°C
Operating Case Temperature Range	No derating	-40		105	°C
Case Material	Tin plated steel with black powder coat				
Storage Temperature	Vin = Zero (no power)	-55		125	°C
Thermal Protection/Shutdown	Measured in center	110	115	120	°C
Electromagnetic Interference	External filter is required				
Conducted, EN55022/CISPR22			B		Class
RoHS rating			RoHS-6		

Notes

- ① Unless otherwise noted, all specifications are at nominal input voltage, nominal output voltage and full load. General conditions are +25° Celsius ambient temperature, near sea level altitude, natural convection airflow. All models are tested and specified with external parallel 1 μF and 10 μF output capacitors. The external input capacitor is 100 μF , electrolytic. All capacitors are low-ESR types wired close to the converter.
- ② Input (back) ripple current is tested and specified over 5 Hz to 20 MHz bandwidth. Input filtering is Cbus=220 μF , Cin=33 μF and Lbus=12 μH .
- ③ The Remote On/Off Control is referred to -Vin.

TYPICAL PERFORMANCE DATA, SPM15-050-Q12

Efficiency vs. Line Voltage and Load Current @ 25°C

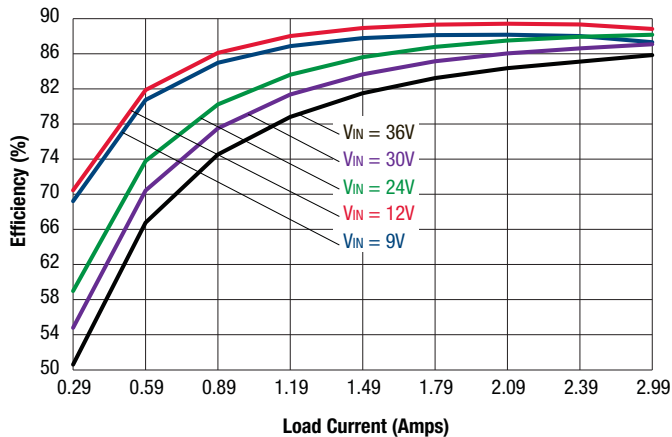

Power Dissipation

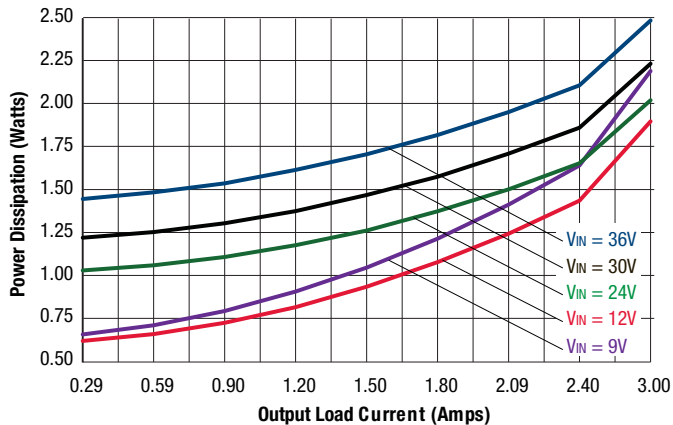

Maximum Current Temperature Derating at sea level
V_{in} = 9V, 12V, or 24V (air flow from Pin J1 to Pin J3 on PCB)

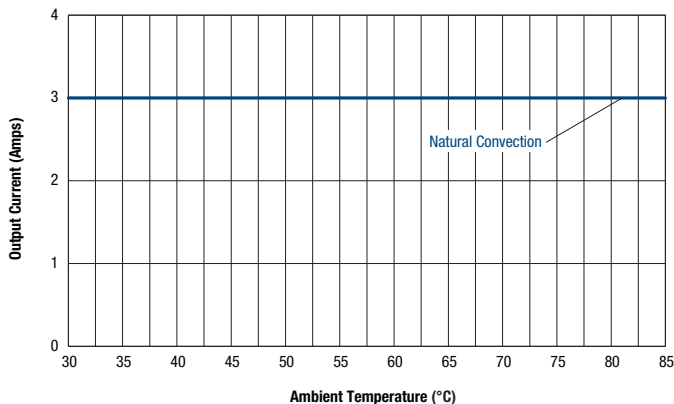

Maximum Current Temperature Derating at sea level
V_{in} = 36V (air flow from Pin J1 to Pin J3 on PCB)

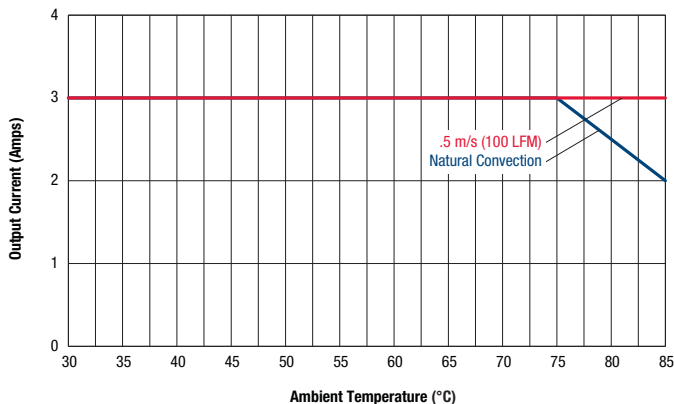

TYPICAL PERFORMANCE DATA, SPM15-050-Q12

Start-up Delay ($V_{in} = 24V$, $I_{out} = 3A$, $C_{load} = 1\mu F \parallel 10\mu F$, $T_a = +25^\circ C$)
CH1 = Vin, CH4 = Vout

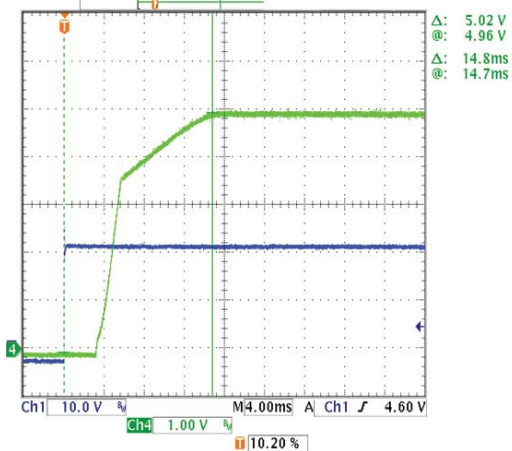

On/Off enable Delay ($V_{in} = 24V$, $I_{out} = 3A$, $C_{load} = 1\mu F \parallel 10\mu F$, $T_a = +25^\circ C$)
CH1 = Enable, CH4 = Vout

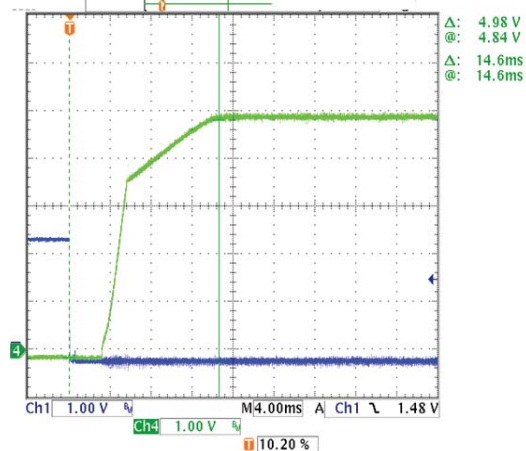

Stepload Transient Response ($V_{in} = 24V$, $I_{out} = 0.75$ to $2.25A$ to $0.75A$,
 $C_{load} = 1\mu F \parallel 10\mu F$, $T_a = +25^\circ C$) CH1 = Iout, CH4 = Vout

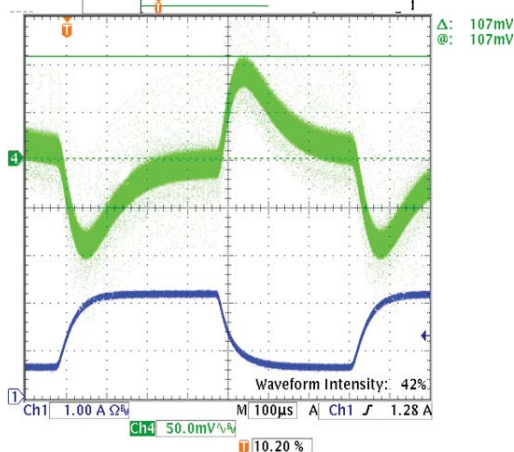

Output Ripple and Noise ($V_{in} = 24V$, $I_{out} = 0.30A$, $C_{load} = 1\mu F \parallel 10\mu F$,
 $T_a = +25^\circ C$, BW = 20Mhz)

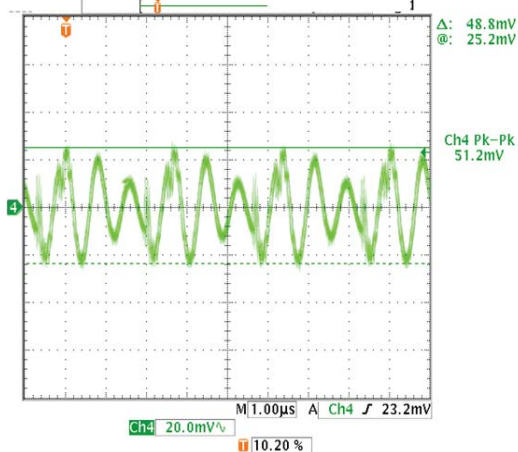

Output Ripple and Noise ($V_{in} = 24V$, $I_{out} = 3A$, $C_{load} = 1\mu F \parallel 10\mu F$,
 $T_a = +25^\circ C$, BW = 20Mhz)

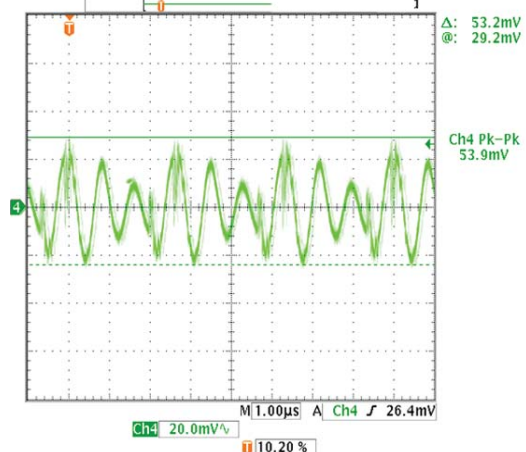

FUNCTIONAL SPECIFICATIONS – MODEL SPM15-050-Q48

ABSOLUTE MAXIMUM RATINGS	Conditions ①	Minimum	Typical/Nominal	Maximum	Units
Input Voltage, Continuous		0		80	Vdc
Input Voltage, Transient	100 mS max. duration			100	Vdc
Isolation Voltage	Input to output			1600	Vdc
On/Off Remote Control	Power on, referred to -Vin	0		15	Vdc
Output Power		1.48		15.23	W
Output Current	Current-limited, no damage, short-circuit protected	0.3		3	A
Storage Temperature Range	Vin = Zero (no power)	-55		125	°C
Absolute maximums are stress ratings. Exposure of devices to greater than any of these conditions may adversely affect long-term reliability. Proper operation under conditions other than those listed in the Performance/Functional Specifications Table is not implied or recommended.					
INPUT					
Operating Voltage Range		18	48	75	Vdc
Recommended External Fuse	Fast blow			1.5	A
Start-up Threshold	Rising input voltage	16	16.9	17.9	Vdc
Undervoltage Shutdown	Falling input voltage	15	16	17.5	Vdc
Internal Filter Type			C		
Input Current					
Full Load Input Current	Vin = nominal		0.35	0.37	A
Low Line Input Current	Vin = minimum		0.93	0.97	A
Inrush Transient			0.05		A ² -Sec.
Short Circuit Input Current			0.05	0.1	mA
Minimum Load Input Current	Iout = minimum, unit=ON		56	90	mA
Shut-Down Input Current (Off, UV, OT)			1	2	mA
Reflected (Back) Ripple Current ②	Measured at input with specified filter		30		mA, p-p
GENERAL and SAFETY					
Efficiency	Vin = 48V, full load	86.5	88.5		%
	Vin = min., full load	87.5	89.5		%
Isolation					
Isolation Voltage	Input to output			1600	Vdc
Isolation Resistance			10		MΩ
Isolation Capacitance			1500		pF
Safety	Certified to UL-60950-1, CSA-C22.2 No. 60950-1, IEC/60950-1, 2nd edition, with AM1		Yes		
Calculated MTBF	Per Telcordia SR332, issue 1, class 3, ground fixed, Tambient = +25°C		2		Hours x 10 ⁶
DYNAMIC CHARACTERISTICS					
Fixed Switching Frequency		320	345	375	KHz
Startup Time	Power on to Vout regulated		10	50	mS
Startup Time	Remote ON to Vout regulated		10	100	mS
Dynamic Load Response	50-75-50% load step, settling time to within 1% of Vout		60	120	μSec
Dynamic Load Peak Deviation	same as above		±50	±150	mV
FEATURES and OPTIONS					
Remote On/Off Control ③					
"N" suffix					
Negative Logic, ON state	ON = Ground pin	-0.7		0.8	V
Negative Logic, OFF state	OFF = Pin open	10		15	V
Control Current	Open collector/drain		1		mA
"P" suffix					
Positive Logic, ON state	ON = Pin open	10		15	V
Positive Logic, OFF state	OFF = Ground pin	-0.7		0.7	V
Control Current	Open collector/drain		1		mA

FUNCTIONAL SPECIFICATIONS (CONT.) – MODEL SPM15-050-Q48

OUTPUT	Conditions ① ③	Minimum	Typical/Nominal	Maximum	Units
Total Output Power		1.48	15	15.23	W
Voltage					
Nominal Output Voltage	No trim	4.925	5	5.075	Vdc
Setting Accuracy	At 50% load, no trim	-1.5		1.5	% of Vnom
Output Voltage Range	User-adjustable	-10		10	% of Vnom.
Overvoltage Protection	Via magnetic feedback	6	7	8	Vdc
Current					
Output Current Range		0.3	3	3	A
Current Limit Inception	98% of Vnom., after warmup	3.75	4.5	5.5	A
Short Circuit					
Short Circuit Current	Hiccup technique, autorecovery within $\pm 1.25\%$ of Vout			0.3	A
Short Circuit Duration (remove short for recovery)	Output shorted to ground, no damage		Continuous		
Short circuit protection method	Current limiting				
Regulation					
Line Regulation	Vin = min. to max., Vout = nom., Iout = nom.			± 0.3	% of Vout
Load Regulation	Iout = min. to max., Vin = 48V			± 0.2	% of Vout
Ripple and Noise	5 Hz- 20 MHz BW, Vin=48V		60	95	mV pk-pk
Maximum Capacitive Loading	Low ESR			470	μ F
MECHANICAL					
Outline Dimensions			1 x 1 x 0.41		Inches
(Please refer to outline drawing)	WxLxH		25.4 x 25.4 x 10.41		mm
Weight			0.69		Ounces
			19.56		Grams
Through Hole Pin Diameter			0.04		Inches
			1.016		mm
Through Hole Pin Material			Copper alloy		
TH Pin Plating Metal and Thickness	Nickel subplate		50		μ -inches
	Gold overplate		5		μ -inches
ENVIRONMENTAL					
Operating Ambient Temperature Range	See derating	-40		85	$^{\circ}$ C
Operating Case Temperature Range	No derating	-40		85	$^{\circ}$ C
Case Material	Tin plated steel with black powder coat				
Storage Temperature	Vin = Zero (no power)	-55		125	$^{\circ}$ C
Thermal Protection/Shutdown	Measured in center	130	135	150	$^{\circ}$ C
Electromagnetic Interference	External filter is required				
Conducted, EN55022/CISPR22			B		Class
RoHS rating			RoHS-6		

Notes

- ① Unless otherwise noted, all specifications are at nominal input voltage, nominal output voltage and full load. General conditions are +25 $^{\circ}$ Celsius ambient temperature, near sea level altitude, natural convection airflow. All models are tested and specified with external parallel 1 μ F and 10 μ F output capacitors. The external input capacitor is 100 μ F, electrolytic. All capacitors are low-ESR types wired close to the converter.
- ② Input (back) ripple current is tested and specified over 5 Hz to 20 MHz bandwidth. Input filtering is Cbus=220 μ F, Cin=33 μ F and Lbus=12 μ H.
- ③ The Remote On/Off Control is referred to -Vin.

TYPICAL PERFORMANCE DATA, SPM15-050-Q48

Efficiency vs. Line Voltage and Load Current @ 25°C

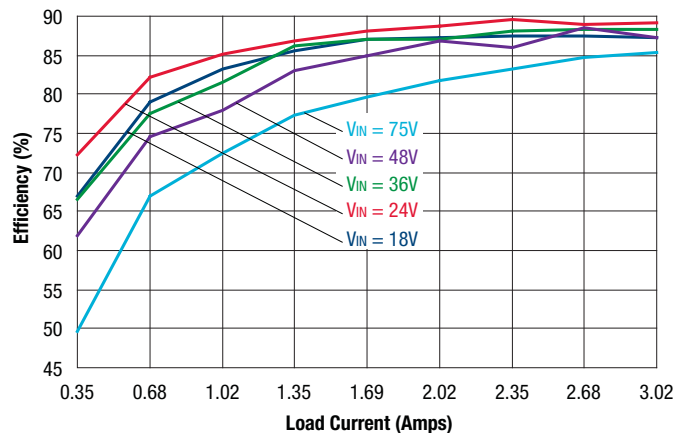

Power Dissipation

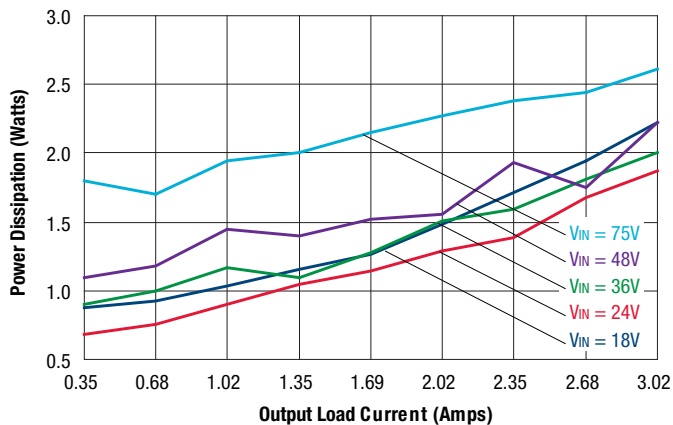

Maximum Current Temperature Derating at sea level
Vin = 18V, 24V, 36V, or 48V (air flow from Pin 1 to Pin 2 on PCB)

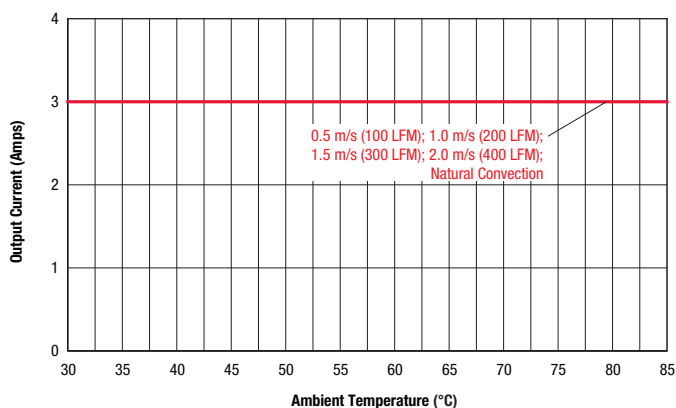

Maximum Current Temperature Derating at sea level
Vin 60 (air flow from Pin 1 to Pin 2 on PCB)

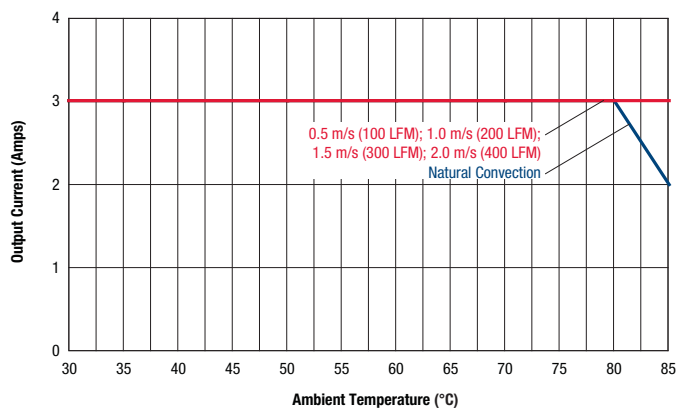

Maximum Current Temperature Derating at sea level
Vin 75 (air flow from Pin 1 to Pin 2 on PCB)

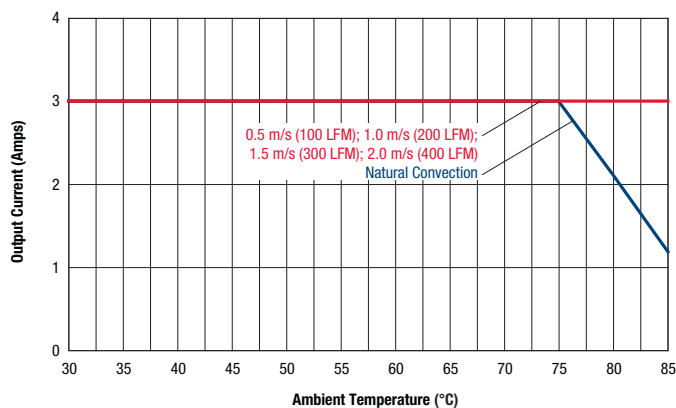

FUNCTIONAL SPECIFICATIONS – MODEL SPM15-120-Q12

ABSOLUTE MAXIMUM RATINGS	Conditions ①	Minimum	Typical/Nominal	Maximum	Units
Input Voltage, Continuous		0		36	Vdc
Input Voltage, Transient	100 mS max. duration			50	Vdc
Isolation Voltage	Input to output			1600	Vdc
On/Off Remote Control	Power on, referred to -Vin	0		15	Vdc
Output Power		1.54		15.76	W
Output Current	Current-limited, no damage, short-circuit protected	0.13		1.3	A
Storage Temperature Range	Vin = Zero (no power)	-55		125	°C
Absolute maximums are stress ratings. Exposure of devices to greater than any of these conditions may adversely affect long-term reliability. Proper operation under conditions other than those listed in the Performance/Functional Specifications Table is not implied or recommended.					
INPUT					
Operating Voltage Range		9	24	36	Vdc
Recommended External Fuse	Fast blow			4	A
Start-up Threshold	Rising input voltage	8	8.5	9	Vdc
Undervoltage Shutdown	Falling input voltage	7.9	8.2	8.7	Vdc
Internal Filter Type			C		
Input Current					
Full Load Input Current	Vin = nominal		0.77	0.8	A
Low Line Input Current	Vin = minimum		2.05	2.11	A
Inrush Transient			0.05		A ² -Sec.
Short Circuit Input Current			50	120	mA
Minimum Load Input Current	Iout = minimum, unit=ON		105	130	mA
Shut-Down Input Current (Off, UV, OT)			1	2.5	mA
Reflected (Back) Ripple Current ②	Measured at input with specified filter		30		mA, p-p
GENERAL and SAFETY					
Efficiency	Vin = 24V, full load	82.5	84		%
	Vin = min., full load	83	84.5		%
Isolation					
Isolation Voltage	Input to output	1600			Vdc
Isolation Resistance			10		MΩ
Isolation Capacitance			1500		pF
Safety	Certified to UL-60950-1, CSA-C22.2 No. 60950-1, IEC/60950-1, 2nd edition, with AM1		Yes		
Calculated MTBF	Per Telcordia SR332, issue 1, class 3, ground fixed, Tambient = +25°C		TBD		Hours x 10 ⁶
DYNAMIC CHARACTERISTICS					
Fixed Switching Frequency		300	330	360	KHz
Startup Time	Power on to Vout regulated		5	50	mS
Startup Time	Remote ON to Vout regulated		5	50	mS
Dynamic Load Response	50-75-50% load step, settling time to within 1% of Vout		60	120	μSec
Dynamic Load Peak Deviation	same as above		±100	±150	mV
FEATURES and OPTIONS					
Remote On/Off Control ③					
"N" suffix					
Negative Logic, ON state	ON = Ground pin	-0.7		0.8	V
Negative Logic, OFF state	OFF = Pin open	10		15	V
Control Current	Open collector/drain		1		mA
"P" suffix					
Positive Logic, ON state	ON = Pin open	10		15	V
Positive Logic, OFF state	OFF = Ground pin	-0.7		0.7	V
Control Current	Open collector/drain		1		mA

FUNCTIONAL SPECIFICATIONS (CONT.) – MODEL SPM15-120-Q12

OUTPUT	Conditions ① ③	Minimum	Typical/Nominal	Maximum	Units
Total Output Power		1.54	15.6	15.76	W
Voltage					
Nominal Output Voltage	No trim	11.88	12	12.12	Vdc
Setting Accuracy	At 50% load, no trim	-1		1	% of Vnom
Output Voltage Range	User-adjustable	-10		10	% of Vnom.
Overvoltage Protection	Via magnetic feedback	15.5	17.2	19.5	Vdc
Current					
Output Current Range		0.13	1.3	1.3	A
Current Limit Inception	98% of Vnom., after warmup	1.5	2.1	2.6	A
Short Circuit					
Short Circuit Current	Hiccup technique, autorecovery within $\pm 1.25\%$ of Vout			0.3	A
Short Circuit Duration (remove short for recovery)	Output shorted to ground, no damage		Continuous		
Short circuit protection method	Current limiting				
Regulation					
Line Regulation	Vin = min. to max., Vout = nom., Iout = nom.			± 0.05	% of Vout
Load Regulation	Iout = min. to max., Vin = 24V			± 0.1	% of Vout
Ripple and Noise	5 Hz- 20 MHz BW, Vin=24V		60	120	mV pk-pk
Temperature Coefficient	At all outputs		± 0.02		% of Vnom./°C
Maximum Capacitive Loading	Low ESR			470	μ F
MECHANICAL					
Outline Dimensions			1 x 1 x 0.41		Inches
(Please refer to outline drawing)	WxLxH		25.4 x 25.4 x 10.41		mm
Weight			0.69		Ounces
			19.56		Grams
Through Hole Pin Diameter			0.04		Inches
			1.016		mm
Through Hole Pin Material			Copper alloy		
TH Pin Plating Metal and Thickness	Nickel subplate		50		μ -inches
	Gold overplate		5		μ -inches
ENVIRONMENTAL					
Operating Ambient Temperature Range	See derating	-40		85	°C
Operating Case Temperature Range	No derating	-40		105	°C
Case Material	Tin plated steel with black powder coat				
Storage Temperature	Vin = Zero (no power)	-55		125	°C
Thermal Protection/Shutdown	Measured in center	110	115	120	°C
Electromagnetic Interference	External filter is required				
Conducted, EN55022/CISPR22			B		Class
RoHS rating			RoHS-6		

Notes

- ① Unless otherwise noted, all specifications are at nominal input voltage, nominal output voltage and full load. General conditions are +25° Celsius ambient temperature, near sea level altitude, natural convection airflow. All models are tested and specified with external parallel 1 μ F and 10 μ F output capacitors. The external input capacitor is 100 μ F, electrolytic. All capacitors are low-ESR types wired close to the converter.
- ② Input (back) ripple current is tested and specified over 5 Hz to 20 MHz bandwidth. Input filtering is Cbus=220 μ F, Cin=33 μ F and Lbus=12 μ H.
- ③ The Remote On/Off Control is referred to -Vin.

TYPICAL PERFORMANCE DATA, SPM15-120-Q12

Efficiency vs. Line Voltage and Load Current @ 25°C

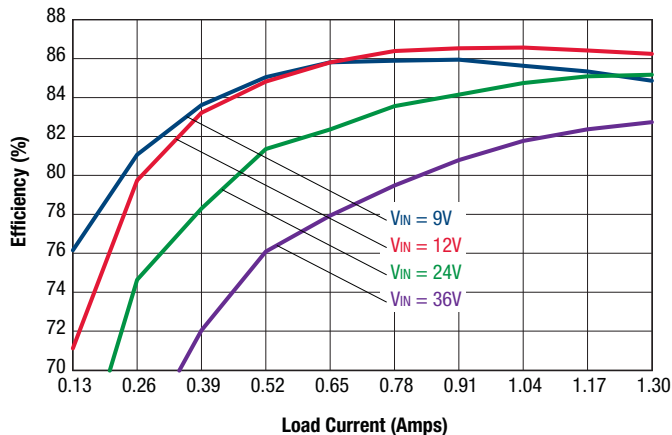

Maximum Current Temperature Derating at sea level
Vin = 9V (air flow from Pin 1 to Pin 2 on PCB)

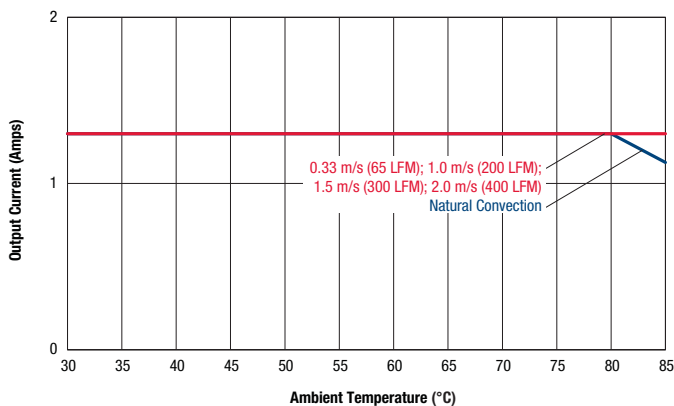

Maximum Current Temperature Derating at sea level
Vin = 12V (air flow from Pin 1 to Pin 2 on PCB)

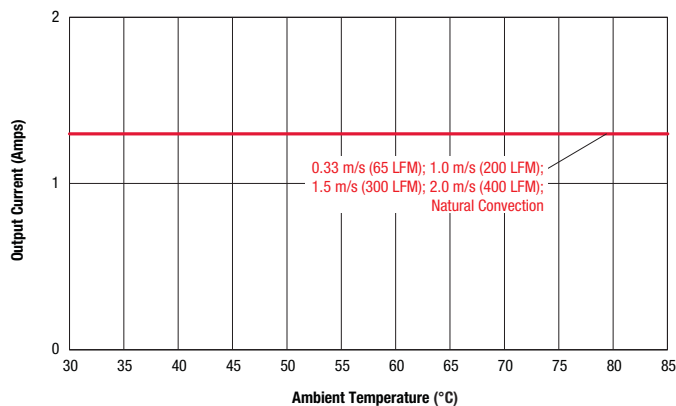

Maximum Current Temperature Derating at sea level
Vin = 24V (air flow from Pin 1 to Pin 2 on PCB)

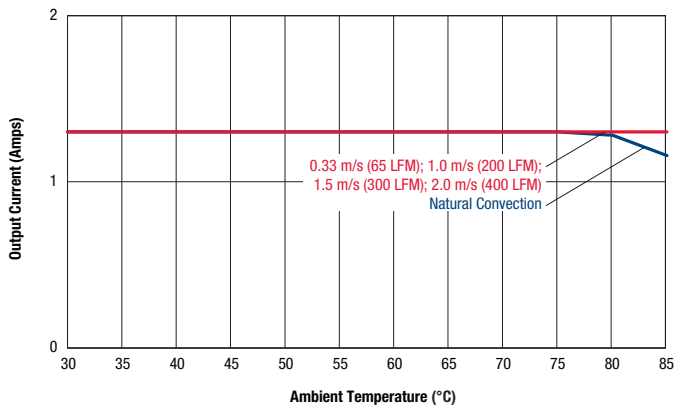

Maximum Current Temperature Derating at sea level
Vin = 36V (air flow from Pin 1 to Pin 2 on PCB)

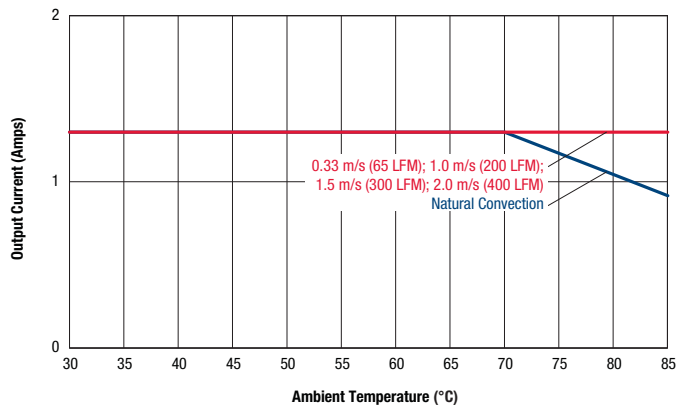

TYPICAL PERFORMANCE DATA, SPM15-120-Q12

Output Ripple and Noise ($V_{in} = 24V$, $I_{out} = 1.3A$, Load = $1\mu F \parallel 10\mu F$, $T_a = +25^\circ C$, BW = 20MHz)

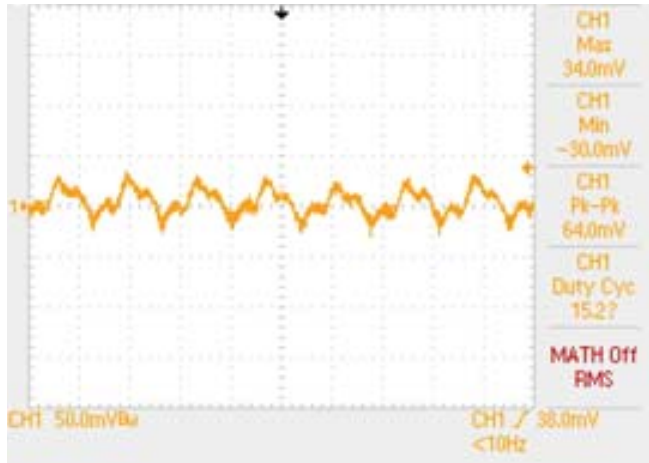

Output Ripple and Noise ($V_{in} = 24V$, $I_{out} = 0.13A$, Load = $1\mu F \parallel 10\mu F$, $T_a = +25^\circ C$, BW = 20MHz)

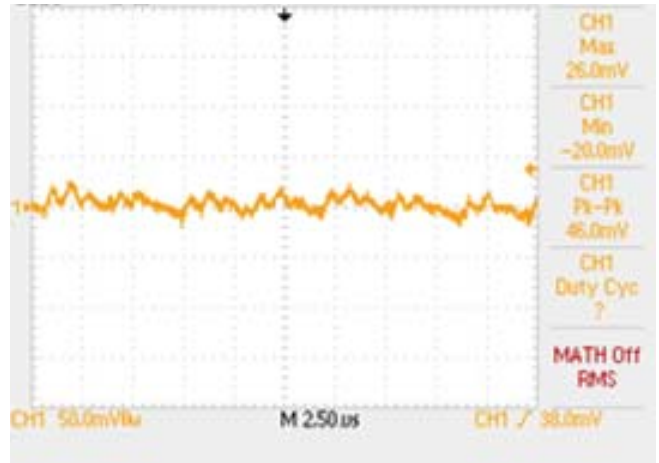

Start-up Delay ($V_{in} = 24V$, $I_{out} = 1.3A$, Load = $470\mu F$, $T_a = +25^\circ C$, CH1 = Vout, CH3 = Vin.)

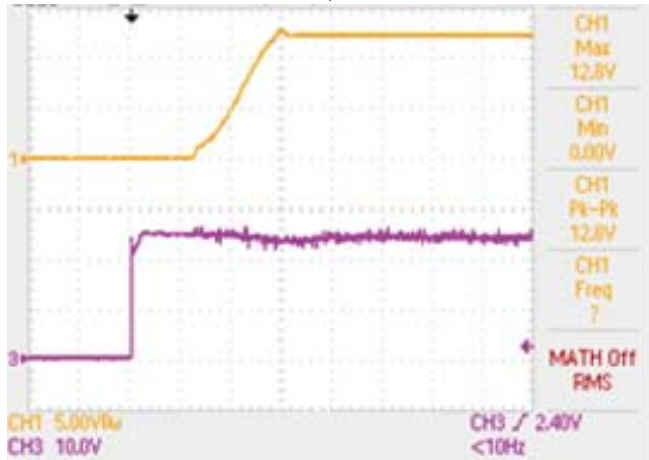

On/Off enable Delay ($V_{in} = 24V$, $I_{out} = 1.3A$, Load = $470\mu F$, $T_a = +25^\circ C$, CH1 = enable, CH2 = Vout.)



Stepload Transient Response ($V_{in} = 24V$, $I_{out} = 50-75-50\%$ of I_{max} , Load = $1\mu F \parallel 10\mu F$, $I_o = 200mA/div$, $T_a = +25^\circ C$, CH2 = Vout, CH4 = Iout)

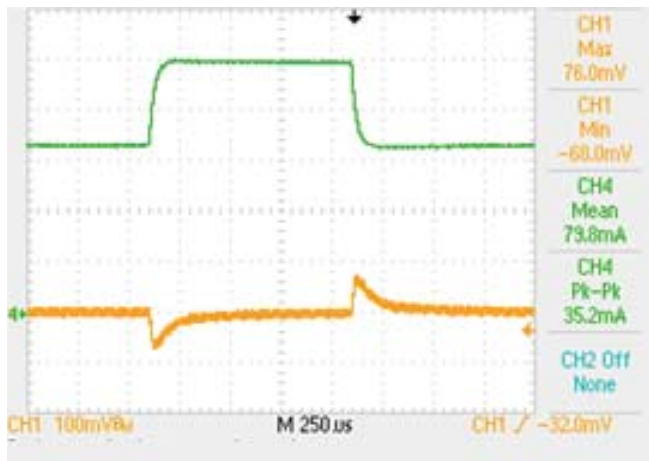

Stepload Transient Response ($V_{in} = 24V$, $I_{out} = 50-75-50\%$ of I_{max} , Load = $470\mu F$, $I_o = 200mA/div$, $T_a = +25^\circ C$, CH2 = Vout, CH4 = Iout)

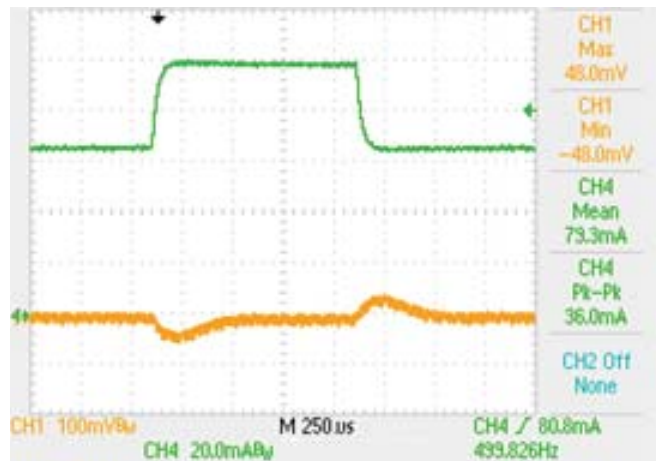

FUNCTIONAL SPECIFICATIONS – MODEL SPM15-120-Q48

ABSOLUTE MAXIMUM RATINGS	Conditions ①	Minimum	Typical/Nominal	Maximum	Units
Input Voltage, Continuous		0		80	Vdc
Input Voltage, Transient	100 mS max. duration			100	Vdc
Isolation Voltage	Input to output			1600	Vdc
On/Off Remote Control	Power on, referred to -Vin	0		15	Vdc
Output Power		1.54		15.76	W
Output Current	Current-limited, no damage, short-circuit protected	0.13		1.3	A
Storage Temperature Range	Vin = Zero (no power)	-55		125	°C
Absolute maximums are stress ratings. Exposure of devices to greater than any of these conditions may adversely affect long-term reliability. Proper operation under conditions other than those listed in the Performance/Functional Specifications Table is not implied or recommended.					
INPUT					
Operating voltage range		18	48	75	Vdc
Recommended External Fuse	Fast blow			1.5	A
Start-up threshold	Rising input voltage	16	16.75	17.5	Vdc
Undervoltage shutdown	Falling input voltage	15	16	17	Vdc
Turn-On/Turn-Off Hysteresis			1.5		Vdc
Internal Filter Type			LC		
Input current					
Full Load Input Current	Vin = 24V		0.76	0.782	A
Full Load Input Current	Vin = 48V		0.387	0.400	A
Low Line Input Current	Vin = minimum		1.032	1.042	
Inrush Transient			0.05		A ² -Sec.
Short Circuit Input Current			50	100	mA
Minimum Load Input Current	Iout = minimum, unit = ON		56	90	mA
Shut-Down Input Current (Off, UV, OT)			1	2	mA
Reflected (back) ripple current ②	Measured at input with specified filter		30		mA, p-p
GENERAL and SAFETY					
Efficiency	Vin = 48V, full load	82	85.5		%
	Vin = 24V, full load	84	84		%
Isolation					
Isolation Voltage	Input to output	1600			Vdc
Isolation Resistance			10		MΩ
Isolation Capacitance			1500		pF
Safety	Certified to UL-60950-1, CSA-C22.2 No. 60950-1, IEC/60950-1, 2nd edition, with AM1		Yes		
Calculated MTBF	Per Telcordia SR332, issue 1, class 3, ground fixed, Tambient = +25°C		6.4		Hours x 10 ⁶
DYNAMIC CHARACTERISTICS					
Fixed Switching Frequency		300	335	370	KHz
Startup Time	Power on to Vout regulated		10	50	mS
Startup Time	Remote ON to Vout regulated		10	50	mS
Dynamic Load Response	50-75-50% load step, settling time to within 1% of Vout		50	100	μSec
Dynamic Load Peak Deviation	same as above		±125	±200	mV
FEATURES and OPTIONS					
Remote On/Off Control ③					
"N" suffix					
Negative Logic, ON state	ON = Ground pin	-0.7		0.8	V
Negative Logic, OFF state	OFF = Pin open	10		15	V
Control Current	Open collector/drain		1		mA
"P" suffix					
Positive Logic, ON state	ON = Pin open	10		15	V
Positive Logic, OFF state	OFF = Ground pin	-0.7		0.7	V
Control Current	Open collector/drain		1		mA

FUNCTIONAL SPECIFICATIONS (CONT.) – MODEL SPM15-120-Q48

OUTPUT	Conditions ① ③	Minimum	Typical/Nominal	Maximum	Units
Total Output Power		1.54	15.6	15.76	W
Voltage					
Nominal Output Voltage	No trim	11.88	12	12.12	Vdc
Setting Accuracy	At 50% load, no trim	-1		1	% of Vnom
Output Voltage Range	User-adjustable	-10		10	% of Vnom.
Overvoltage Protection	Via magnetic feedback	14.5	16.5	17.5	Vdc
Current					
Output Current Range		0.13	1.3	1.3	A
Current Limit Inception	98% of Vnom., after warmup	1.5	1.9	2.3	A
Short Circuit					
Short Circuit Current	Hiccup technique, autorecovery within $\pm 1.25\%$ of Vout			TBD	A
Short Circuit Duration (remove short for recovery)	Output shorted to ground, no damage		Continuous		
Short circuit protection method	Current limiting				
Regulation					
Line Regulation	Vin = min. to max., Vout = nom., Iout = nom.			± 0.075	% of Vout
Load Regulation	Iout = min. to max., Vin = 48V			± 0.05	% of Vout
Ripple and Noise	5 Hz- 20 MHz BW, Vin=48V		85	120	mV pk-pk
Temperature Coefficient	At all outputs		± 0.02		% of Vnom./°C
Maximum Capacitive Loading	Low ESR			470	μ F
MECHANICAL					
Outline Dimensions			1 x 1 x 0.41		Inches
(Please refer to outline drawing)	WxLxH		25.4 x 25.4 x 10.41		mm
Weight			0.69		Ounces
			19.56		Grams
Through Hole Pin Diameter			0.04		Inches
			1.016		mm
Through Hole Pin Material			Copper alloy		
TH Pin Plating Metal and Thickness	Nickel subplate		50		μ -inches
	Gold overplate		5		μ -inches
ENVIRONMENTAL					
Operating Ambient Temperature Range	See Derating	-40		85	°C
Operating Case Temperature Range	No derating	-40		105	°C
Case Material	Tin plated steel with black powder coat				
Storage Temperature	Vin = Zero (no power)	-55		125	°C
Thermal Protection/Shutdown	Measured in center	130	135	150	°C
Electromagnetic Interference	External filter is required				
Conducted, EN55022/CISPR22			B		Class
RoHS rating			RoHS-6		

Notes

- ① Unless otherwise noted, all specifications are at nominal input voltage, nominal output voltage and full load. General conditions are +25° Celsius ambient temperature, near sea level altitude, natural convection airflow. All models are tested and specified with external parallel 1 μ F and 10 μ F output capacitors. The external input capacitor is 4.7 μ F. All capacitors are low-ESR types wired close to the converter.
- ② Input (back) ripple current is tested and specified over 5 Hz to 20 MHz bandwidth. Input filtering is Cbus=220 μ F, Cin=33 μ F and Lbus=12 μ H.
- ③ The Remote On/Off Control is referred to -Vin.

TYPICAL PERFORMANCE DATA, SPM15-120-Q48

Efficiency vs. Line Voltage and Load Current @ 25°C

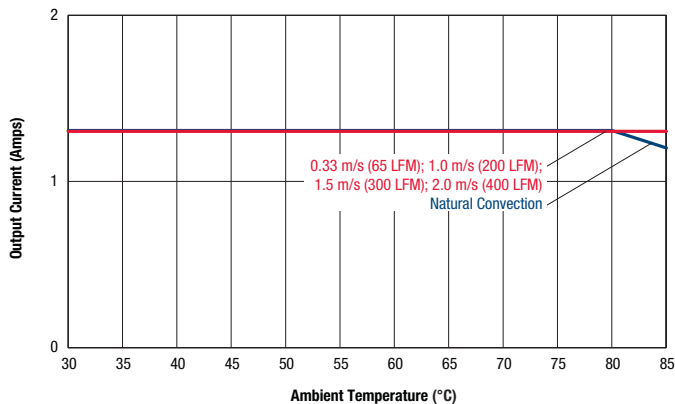

Maximum Current Temperature Derating at sea level
Vin = 18V (air flow from Pin 1 to Pin 2 on PCB)

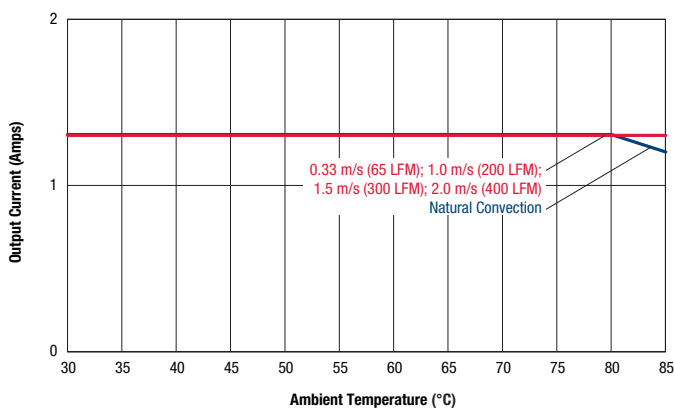

Maximum Current Temperature Derating at sea level
Vin = 24V (air flow from Pin 1 to Pin 2 on PCB)

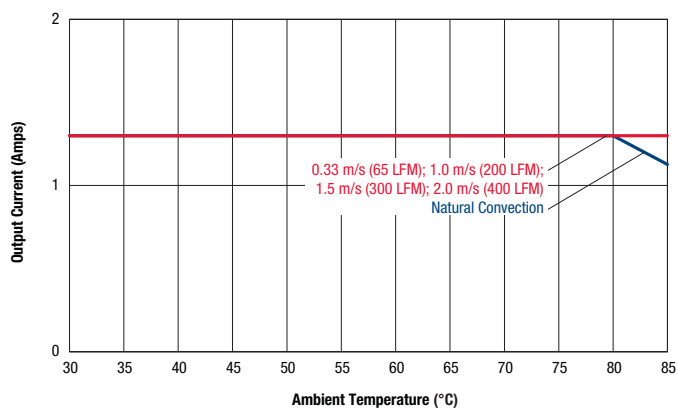

Maximum Current Temperature Derating at sea level
Vin = 48V (air flow from Pin 1 to Pin 2 on PCB)

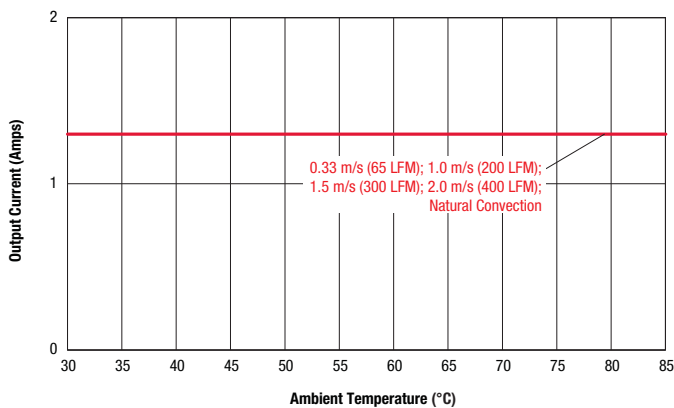

Maximum Current Temperature Derating at sea level
Vin = 75V (air flow from Pin 1 to Pin 2 on PCB)

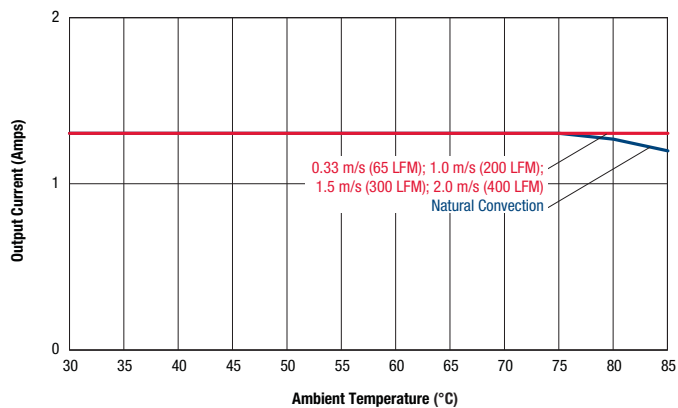

FUNCTIONAL SPECIFICATIONS – MODEL SPM15-150-Q12

ABSOLUTE MAXIMUM RATINGS	Conditions ①	Minimum	Typical/Nominal	Maximum	Units
Input Voltage, Continuous		0		36	Vdc
Input Voltage, Transient	100 mS max. duration			50	Vdc
Isolation Voltage	Input to output			1600	Vdc
On/Off Remote Control	Power on, referred to -Vin	0		15	Vdc
Output Power		1.63		16.67	W
Output Current	Current-limited, no damage, short-circuit protected	0.11		1.1	A
Storage Temperature Range	Vin = Zero (no power)	-55		125	°C
Absolute maximums are stress ratings. Exposure of devices to greater than any of these conditions may adversely affect long-term reliability. Proper operation under conditions other than those listed in the Performance/Functional Specifications Table is not implied or recommended.					
INPUT					
Operating voltage range		9	24	36	Vdc
Recommended External Fuse	Fast blow			4	A
Start-up threshold (@+25°C and -40°C)	Rising input voltage	8	8.5	9	Vdc
Undervoltage shutdown	Falling input voltage	7.8	8.25	9	Vdc
Internal Filter Type			C		
Input current					
Full Load Input Current	Vin = nominal		0.82	0.84	A
Low Line Input Current	Vin = minimum		2.13	2.19	A
Inrush Transient			0.05		A ² -Sec.
Short Circuit Input Current			50	100	mA
Minimum Load Input Current	Iout = minimum, unit = ON		130	150	mA
Shut-Down Input Current (Off, UV, OT)			1	2.5	mA
Reflected (back) ripple current ②	Measured at input with specified filter		30		mA, p-p
GENERAL and SAFETY					
Efficiency	Vin = 24V, full load	82.5	84		%
	Vin = min., full load	84.5	86		%
Isolation					
Isolation Voltage	Input to output	1600			Vdc
Insulation Safety Rating			basic		
Isolation Resistance			10		MΩ
Isolation Capacitance			1500		pF
Safety	Certified to UL-60950-1, CSA-C22.2 No. 60950-1, IEC/60950-1, 2nd edition, with AM1		Yes		
Calculated MTBF	Per Telcordia SR332, issue 1, class 3, ground fixed, Tambient = +25°C		TBD		Hours x 10 ⁶
DYNAMIC CHARACTERISTICS					
Fixed Switching Frequency		300	330	360	KHz
Startup Time	Power on to Vout regulated			50	mS
Startup Time	Remote on to Vout regulated			50	mS
Dynamic Load Response	50-75-50% load step, settling time to within 1% of Vout		100	150	μSec
Dynamic Load Peak Deviation	same as above		±150	±250	mV
FEATURES and OPTIONS					
Remote On/Off Control ③					
"N" suffix					
Negative Logic, ON state	ON = Ground pin	-0.7		0.8	V
Negative Logic, OFF state	OFF = Pin open	10		15	V
Control Current	Open collector/drain		1		mA
"P" suffix					
Positive Logic, ON state	ON = Pin open	10		15	V
Positive Logic, OFF state	OFF = Ground pin	-0.7		0.7	V
Control Current	Open collector/drain		1		mA

FUNCTIONAL SPECIFICATIONS (CONT.) – MODEL SPM15-150-Q12

OUTPUT	Conditions ① ③	Minimum	Typical/Nominal	Maximum	Units
Total Output Power		1.63	16.5	16.67	W
Voltage					
Nominal Output Voltage	No trim	14.85	15	15.15	Vdc
Setting Accuracy	At 50% load, no trim	1		1	% of Vnom
Output Voltage Range	User-adjustable	-10		10	% of Vnom.
Overvoltage Protection	Via magnetic feedback	17	19.5	22.5	Vdc
Current					
Output Current Range		0.11	1.1	1.1	A
Current Limit Inception	98% of Vnom., after warmup	1.2	1.6	2	A
Short Circuit					
Short Circuit Current	Hiccup technique, autorecovery within $\pm 1.25\%$ of Vout			0.3	A
Short Circuit Duration (remove short for recovery)	Output shorted to ground, no damage		Continuous		
Short circuit protection method	Current limiting				
Regulation					
Line Regulation	Vin = min. to max., Vout = nom., Iout = nom.			± 0.1	% of Vout
Load Regulation	Iout = min. to max., Vin = 24V			± 0.1	% of Vout
Ripple and Noise	5 Hz- 20 MHz BW, Vin=24V		130	175	mV pk-pk
Temperature Coefficient	At all outputs		± 0.02		% of Vnom./°C
Maximum Capacitive Loading	Low ESR			470	μ F
MECHANICAL					
Outline Dimensions			1 x 1 x 0.41		Inches
(Please refer to outline drawing)	WxLxH		25.4 x 25.4 x 10.41		mm
Weight			0.69		Ounces
			19.56		Grams
Through Hole Pin Diameter			0.04		Inches
			1.016		mm
Through Hole Pin Material			Copper alloy		
TH Pin Plating Metal and Thickness	Nickel subplate		50		μ -inches
	Gold overplate		5		μ -inches
ENVIRONMENTAL					
Operating Ambient Temperature Range	See Derating	-40		85	°C
Operating Case Temperature Range	No derating	-40		105	°C
Case Material	Tin plated steel with black powder coat				
Storage Temperature	Vin = Zero (no power)	-55		125	°C
Thermal Protection/Shutdown	Measured in center	110	115	120	°C
Electromagnetic Interference	External filter is required				
Conducted, EN55022/CISPR22			B		Class
RoHS rating			RoHS-6		

Notes

- ① Unless otherwise noted, all specifications are at nominal input voltage, nominal output voltage and full load. General conditions are +25° Celsius ambient temperature, near sea level altitude, natural convection airflow. All models are tested and specified with external parallel 1 μ F and 10 μ F output capacitors. The external input capacitor is 100 μ F, electrolytic. All capacitors are low-ESR types wired close to the converter.
- ② Input (back) ripple current is tested and specified over 5 Hz to 20 MHz bandwidth. Input filtering is Cbus=220 μ F, Cin=33 μ F and Lbus=12 μ H.
- ③ The Remote On/Off Control is referred to -Vin.

TYPICAL PERFORMANCE DATA, SPM15-150-Q12

Efficiency vs. Line Voltage and Load Current @ 25°C

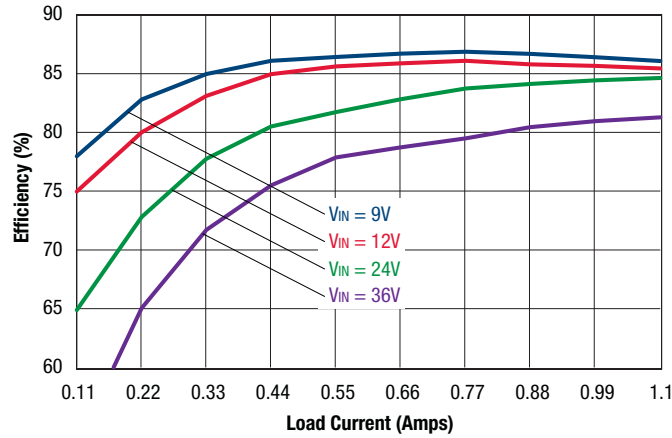

Maximum Current Temperature Derating at sea level
Vin = 9, 12, or 24V (unit mounted on PCB)*

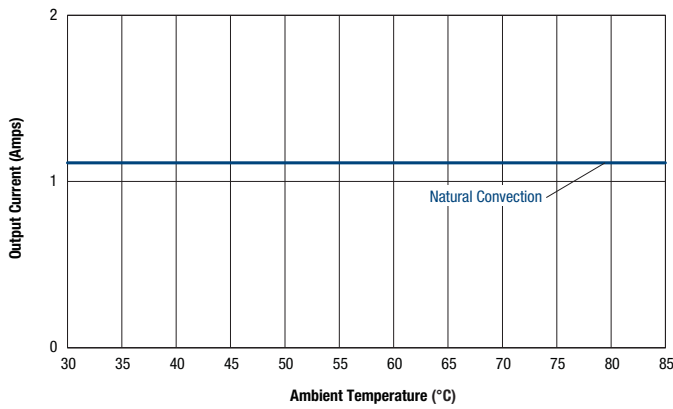

Maximum Current Temperature Derating at sea level
Vin = 36V (air flow is from J1 to J3 on PCB)*

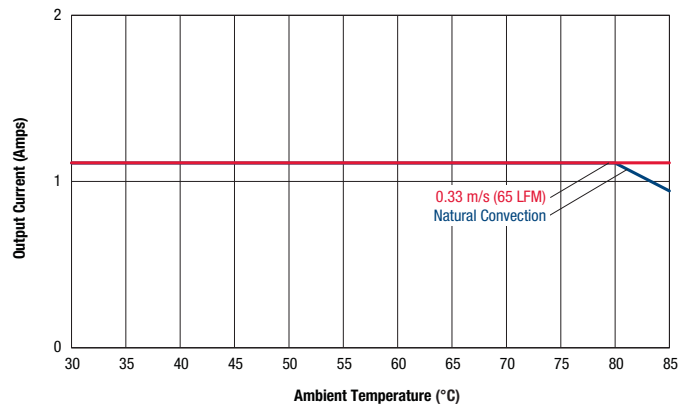

*Using Burn in board, connection with solder

TYPICAL PERFORMANCE DATA, SPM15-150-Q12

Output Ripple and Noise (Vin = 24V, Iout = 0.11A, Cload = 1μF || 10μF, Ta = +25°C, BW = 20MHz)

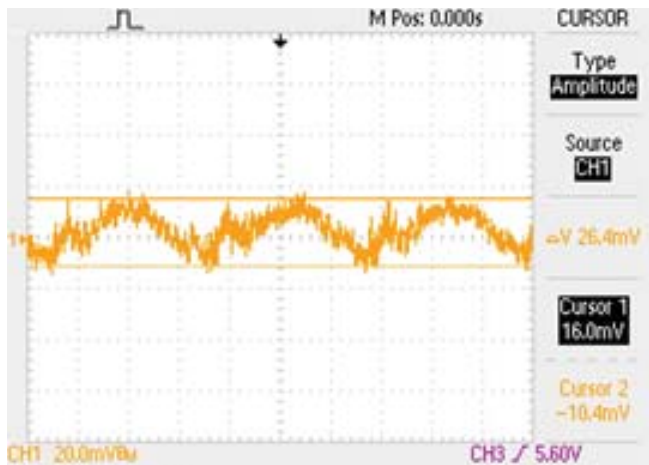

Output Ripple and Noise (Vin = 24V, Iout = 1.1A, Cload = 1μF || 10μF, Ta = +25°C, BW = 20MHz)

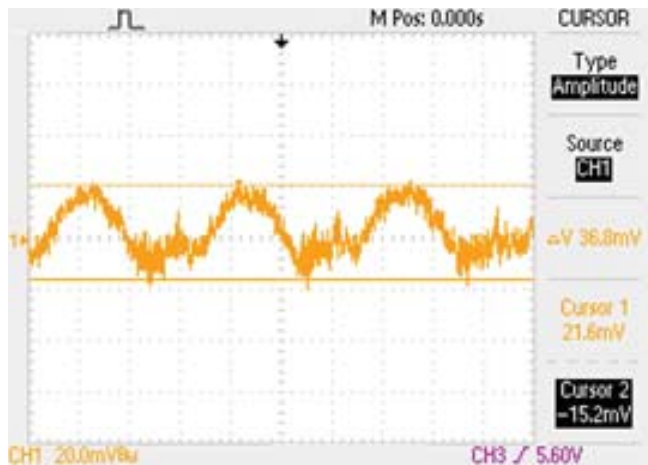

Start-up Delay (Vin = 24V, Iout = 1.1A, Cload = 1μF || 10μF, Ta = +25°C) CH1 = Vout, CH3 = Vin

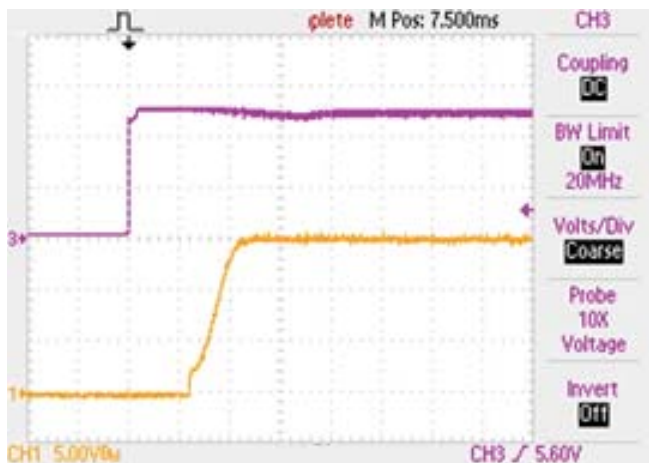

On/Off enable Delay (Vin = 24V, Iout = 1.1A, Cload = 1μF || 10μF, Ta = +25°C) CH1 = Vout, CH3 = Enable

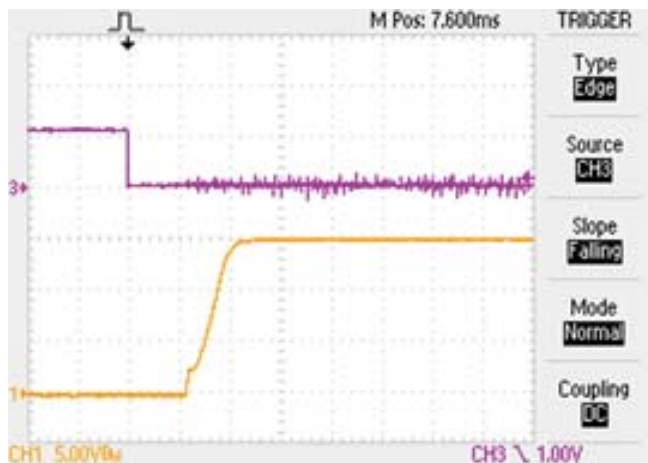

Stepload Transient Response (Vin = 24V, Iout = 50% to 75%, Cload = 1μF || 10μF, Ta = +25°C) CH1 = Vout, CH4 = Iout

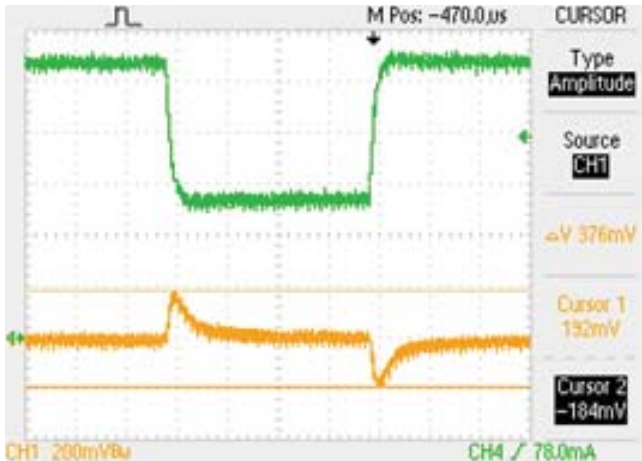

FUNCTIONAL SPECIFICATIONS – MODEL SPM15-150-Q48

ABSOLUTE MAXIMUM RATINGS	Conditions ①	Minimum	Typical/Nominal	Maximum	Units
Input Voltage, Continuous		0		80	Vdc
Input Voltage, Transient	100 mS max. duration			100	Vdc
Isolation Voltage	Input to output			1600	Vdc
On/Off Remote Control	Power on, referred to -Vin	0		15	Vdc
Output Power		1.63		16.67	W
Output Current	Current-limited, no damage, short-circuit protected	0.11		1.1	A
Storage Temperature Range	Vin = Zero (no power)	-55		125	°C
Absolute maximums are stress ratings. Exposure of devices to greater than any of these conditions may adversely affect long-term reliability. Proper operation under conditions other than those listed in the Performance/Functional Specifications Table is not implied or recommended.					
INPUT					
Operating voltage range		18	48	75	Vdc
Recommended External Fuse	Fast blow			2	A
Start-up threshold	Rising input voltage	16	16.7	17.9	Vdc
Undervoltage shutdown	Falling input voltage	15	16.2	17.5	Vdc
Internal Filter Type			C		
Input current					
Full Load Input Current	Vin = nominal		0.41	0.42	A
Low Line Input Current	Vin = minimum		1.06	1.09	A
Inrush Transient			0.05		A ² -Sec.
Short Circuit Input Current			50	100	mA
Minimum Load Input Current	Iout = minimum, unit = ON		60	85	mA
Shut-Down Input Current (Off, UV, OT)			1	2	mA
Reflected (back) ripple current ②	Measured at input with specified filter		30		mA, p-p
GENERAL and SAFETY					
Efficiency	Vin = 48V, full load	83	85.5		%
	Vin = min., full load	85	86.5		%
Isolation					
Isolation Voltage	Input to output	1600			Vdc
Insulation Safety Rating			basic		
Isolation Resistance			10		MΩ
Isolation Capacitance			1500		pF
Safety	Certified to UL-60950-1, CSA-C22.2 No. 60950-1, IEC/60950-1, 2nd edition, with AM1		Yes		
Calculated MTBF	Per Telcordia SR332, issue 1, class 3, ground fixed, Tambient = +25°C		TBD		Hours x 10 ⁶
DYNAMIC CHARACTERISTICS					
Fixed Switching Frequency		300	330	360	KHz
Startup Time	Power on to Vout regulated			50	mS
Startup Time	Remote on to Vout regulated			50	mS
Dynamic Load Response	50-75-50% load step, settling time to within 1% of Vout		60	120	µSec
Dynamic Load Peak Deviation	same as above		±150	±250	mV
FEATURES and OPTIONS					
Remote On/Off Control ③					
"N" suffix					
Negative Logic, ON state	ON = Ground pin	-0.7		0.8	V
Negative Logic, OFF state	OFF = Pin open	10		15	V
Control Current	Open collector/drain		1		mA
"P" suffix					
Positive Logic, ON state	ON = Pin open	10		15	V
Positive Logic, OFF state	OFF = Ground pin	-0.7		0.7	V
Control Current	Open collector/drain		1		mA

FUNCTIONAL SPECIFICATIONS (CONT.) – MODEL SPM15-150-Q48

OUTPUT	Conditions ① ③	Minimum	Typical/Nominal	Maximum	Units
Total Output Power		1.63	16.5	16.67	W
Voltage					
Nominal Output Voltage	No trim	14.85	15	15.15	Vdc
Setting Accuracy	At 50% load, no trim	1		1	% of Vnom
Output Voltage Range	User-adjustable	-10		10	% of Vnom.
Overvoltage Protection	Via magnetic feedback	19	20	21.5	Vdc
Current					
Output Current Range		0.11	1.1	1.1	A
Current Limit Inception	98% of Vnom., after warmup	1.3	1.7	2.2	A
Short Circuit					
Short Circuit Current	Hiccup technique, autorecovery within ±1.25% of Vout			0.3	A
Short Circuit Duration (remove short for recovery)	Output shorted to ground, no damage		Continuous		
Short circuit protection method	Current limiting				
Regulation					
Line Regulation	Vin = min. to max., Vout = nom., Iout = nom.			±0.1	% of Vout
Load Regulation	Iout = min. to max., Vin = 48V			±0.075	% of Vout
Ripple and Noise	5 Hz- 20 MHz BW, Vin=24V		80	150	mV pk-pk
Temperature Coefficient	At all outputs		±0.02		% of Vnom./°C
Maximum Capacitive Loading	Low ESR			470	µF
MECHANICAL					
Outline Dimensions			1 x 1 x 0.41		Inches
(Please refer to outline drawing)	WxLxH		25.4 x 25.4 x 10.41		mm
Weight			0.69		Ounces
			19.56		Grams
Through Hole Pin Diameter			0.04		Inches
			1.016		mm
Through Hole Pin Material			Copper alloy		
TH Pin Plating Metal and Thickness	Nickel subplate		50		µ-inches
	Gold overplate		5		µ-inches
ENVIRONMENTAL					
Operating Ambient Temperature Range	See Derating	-40		85	°C
Operating Case Temperature Range	No derating	-40		105	°C
Case Material	Tin plated steel with black powder coat				
Storage Temperature	Vin = Zero (no power)	-55		125	°C
Thermal Protection/Shutdown	Measured in center	110	115	120	°C
Electromagnetic Interference	External filter is required				
Conducted, EN55022/CISPR22			B		Class
RoHS rating			RoHS-6		

Notes

- ① Unless otherwise noted, all specifications are at nominal input voltage, nominal output voltage and full load. General conditions are +25° Celsius ambient temperature, near sea level altitude, natural convection airflow. All models are tested and specified with external parallel 1 µF and 10 µF output capacitors. The external input capacitor is 4.7 µF. All capacitors are low-ESR types wired close to the converter.
- ② Input (back) ripple current is tested and specified over 5 Hz to 20 MHz bandwidth. Input filtering is Cbus=220 µF, Cin=33 µF and Lbus=12 µH.
- ③ The Remote On/Off Control is referred to -Vin.

TYPICAL PERFORMANCE DATA, SPM15-150-Q48

Efficiency vs. Line Voltage and Load Current @ 25°C

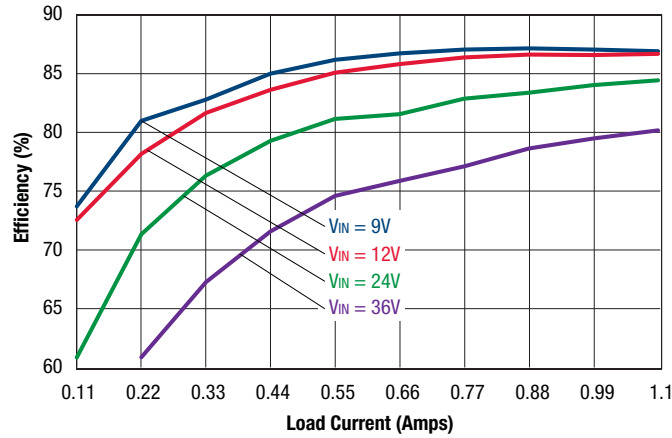

Maximum Current Temperature Derating at sea level
Vin = 18, 24, or 36V (air flow from J 1 to J3 on PCB)*

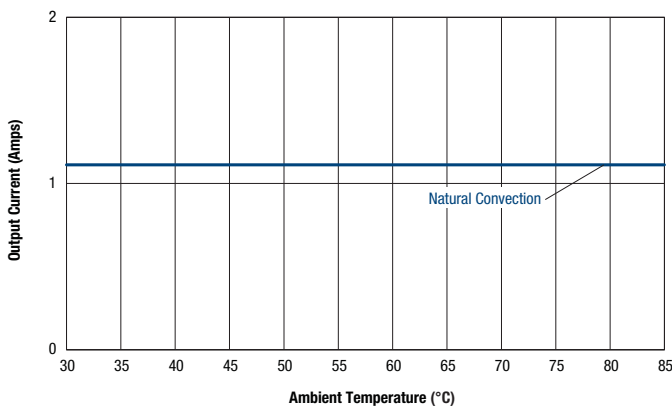

Maximum Current Temperature Derating at sea level
Vin = 48V (air flow from J 1 to J3 on PCB)*

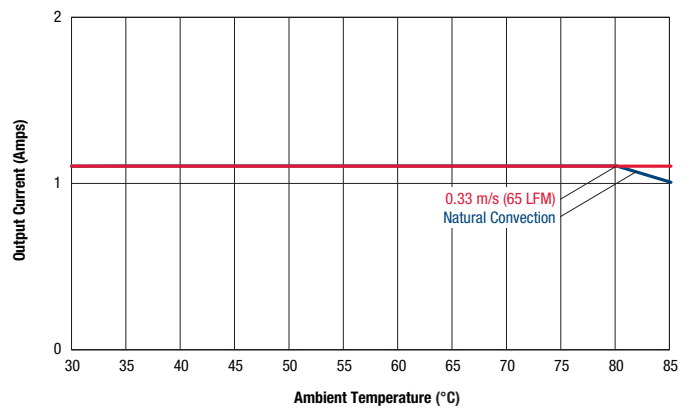

Maximum Current Temperature Derating at sea level
Vin = 60V (air flow from J 1 to J3 on PCB)*

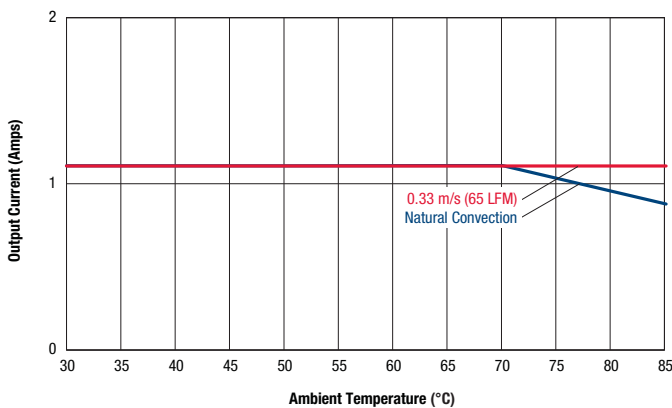

Maximum Current Temperature Derating at sea level
Vin = 75V (air flow from J 1 to J3 on PCB)*

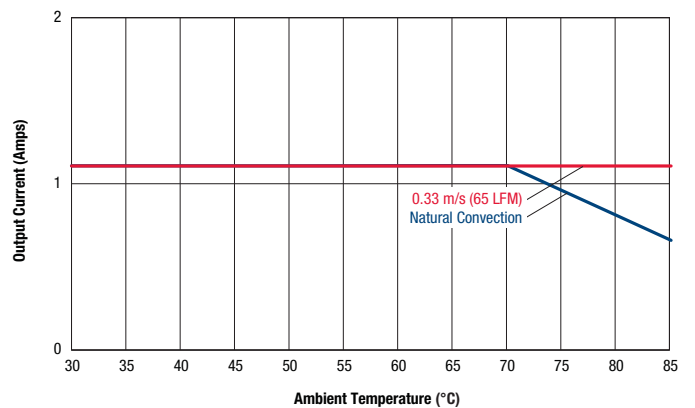

*Using Burn in board, connection with solder

TYPICAL PERFORMANCE DATA, SPM15-150-Q48

Output Ripple and Noise (Vin = 48V, Iout = 0.11A, Load = 1μF || 10μF, Ta = +25°C, BW = 20MHz)

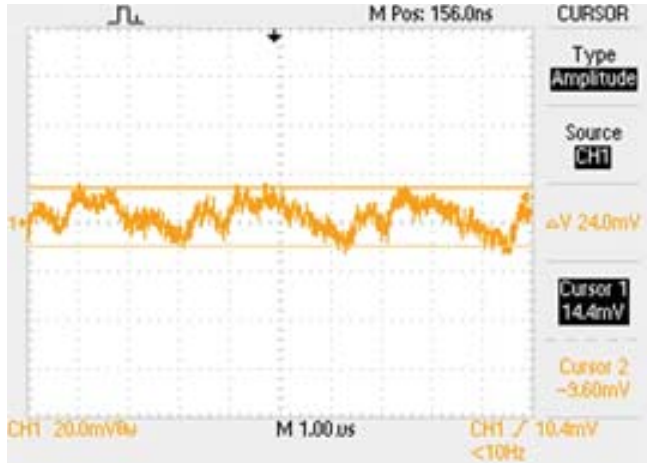

Output Ripple and Noise (Vin = 48V, Iout = 1.1A, Load = 1μF || 10μF, Ta = +25°C, BW = 20MHz)

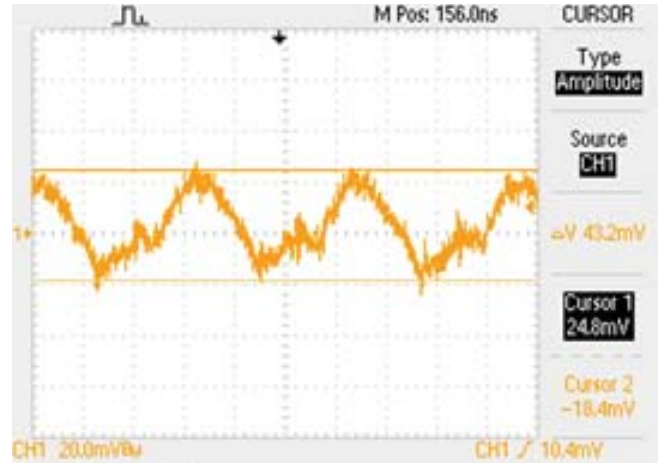

Start-up Delay (Vin = 48V, Iout = 1.1A, Load = 1μF || 10μF, Ta = +25°C) CH1 = Vout, CH3 = Vin

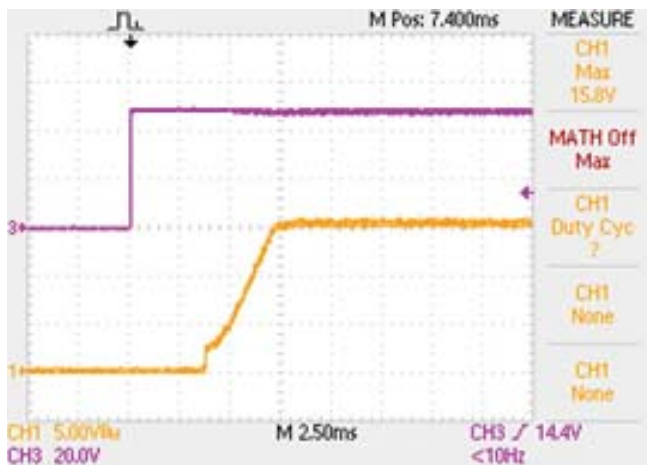

On/Off enable Delay (Vin = 48V, Iout = 1.1A, Load = 1μF || 10μF, Ta = +25°C) CH1 = Vout, CH3 = Enable

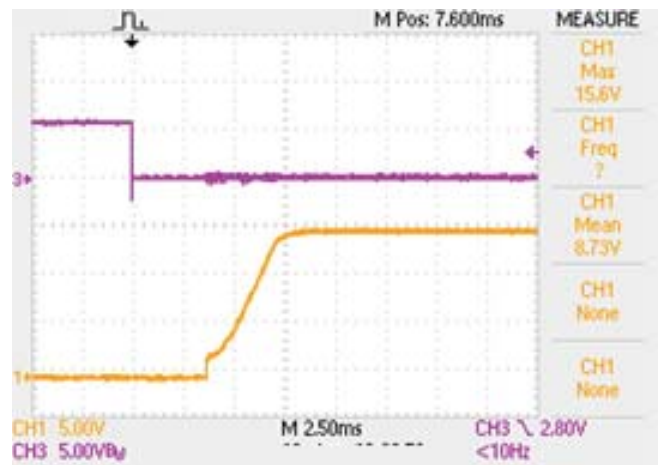

Stepload Transient Response (Vin = 48V, Iout = 50% to 75%, Load = 1μF || 10μF, Ta = +25°C) CH1 = Vout, CH4 = Iout

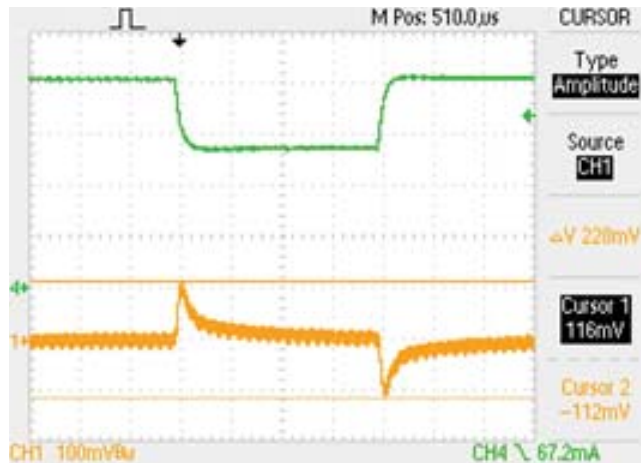

MECHANICAL SPECIFICATIONS

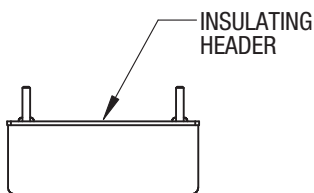
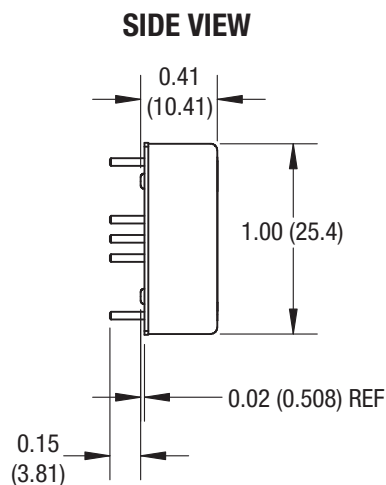
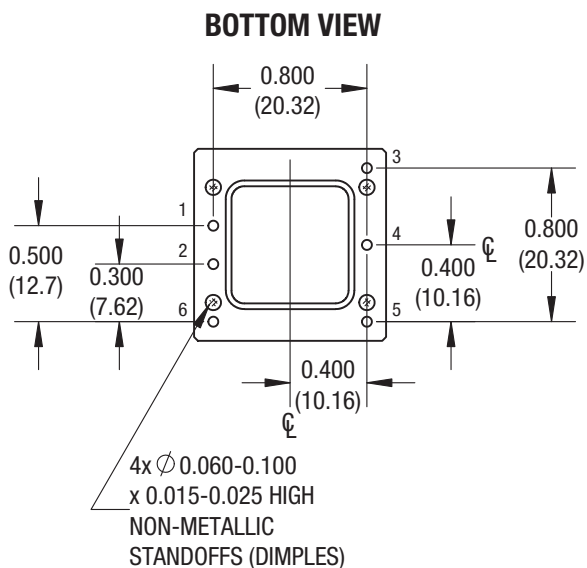

END VIEW

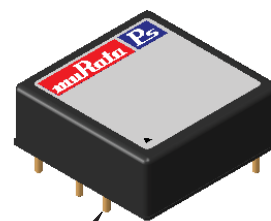

ISOMETRIC VIEW (FOR REF ONLY)

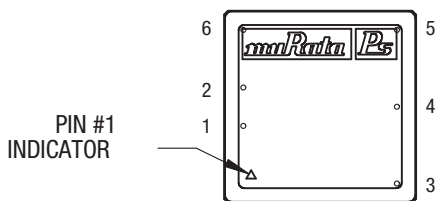

TOP VIEW

MATERIAL:
Ø .040 PINS: COPPER ALLOY

FINISH: (ALL PINS)
GOLD (5µ" MIN) OVER NICKEL (50µ" MIN)

INPUT/OUTPUT CONNECTIONS	
Pin	SPM Function (Single Output)
1	+Vin
2	-Vin
3	+Vout
4	Output Trim*
5	-Vout
6	On/Off Control*

The Remote On/Off can be provided with either positive (P suffix) or negative (N suffix) logic. See part number structure for options.

Dimensions are in inches (mm shown for ref. only).

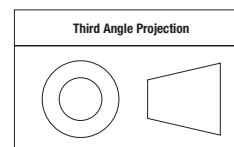

Tolerances (unless otherwise specified):
.XX ± 0.02 (0.5)
.XXX ± 0.010 (0.25)
Angles ± 2°

Components are shown for reference only.

RECOMMENDED FOOTPRINT (VIEW THROUGH CONVERTER)

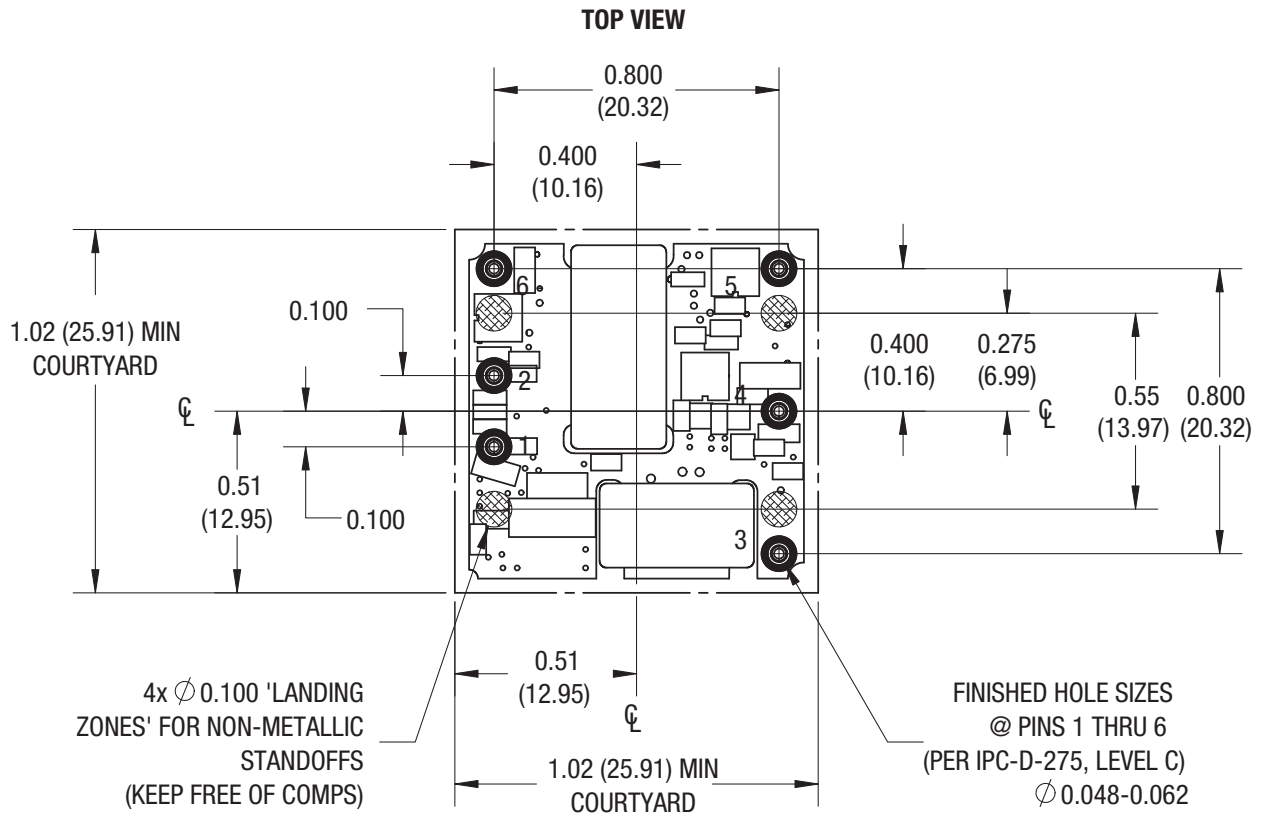

STANDARD PACKAGING

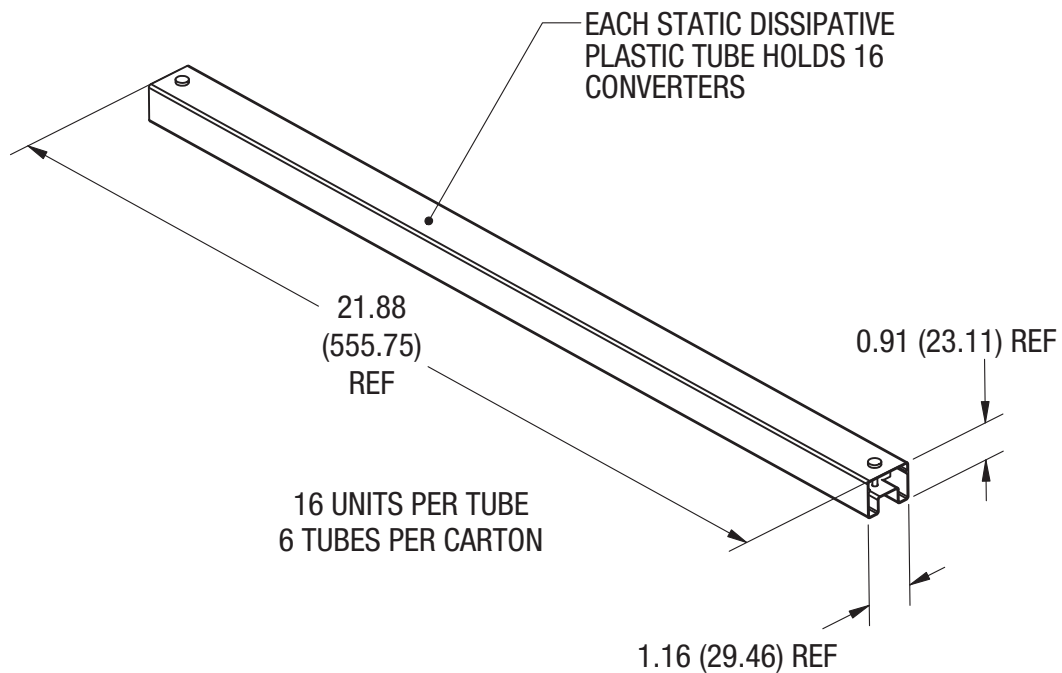

TECHNICAL NOTES

Input Fusing

Certain applications and/or safety agencies may require fuses at the inputs of power conversion components. Fuses should also be used when there is the possibility of sustained input voltage reversal which is not current-limited. For greatest safety, we recommend a fast blow fuse installed in the ungrounded input supply line.

The installer must observe all relevant safety standards and regulations. For safety agency approvals, install the converter in compliance with the end-user safety standard.

Input Under-Voltage Shutdown and Start-Up Threshold

Under normal start-up conditions, converters will not begin to regulate properly until the rising input voltage exceeds and remains at the Start-Up Threshold Voltage (see Specifications). Once operating, converters will not turn off until the input voltage drops below the Under-Voltage Shutdown Limit. Subsequent restart will not occur until the input voltage rises again above the Start-Up Threshold. This built-in hysteresis prevents any unstable on/off operation at a single input voltage.

Users should be aware however of input sources near the Under-Voltage Shutdown whose voltage decays as input current is consumed (such as capacitor inputs), the converter shuts off and then restarts as the external capacitor re-charges. Such situations could oscillate. To prevent this, make sure the operating input voltage is well above the UV Shutdown voltage AT ALL TIMES.

Start-Up Delay

Assuming that the output current is set at the rated maximum, the V_{in} to V_{out} Start-Up Delay (see Specifications) is the time interval between the point when the rising input voltage crosses the Start-Up Threshold and the fully loaded regulated output voltage enters and remains within its specified regulation band. Actual measured times will vary with input source impedance, external input capacitance, input voltage slew rate and final value of the input voltage as it appears at the converter.

These converters include a soft start circuit to moderate the duty cycle of the PWM controller at power up, thereby limiting the input inrush current.

The On/Off Remote Control interval from inception to V_{out} regulated assumes that the converter already has its input voltage stabilized above the Start-Up Threshold before the On command. The interval is measured from the On command until the output enters and remains within its specified regulation band. The specification assumes that the output is fully loaded at maximum rated current.

Input Source Impedance

These converters will operate to specifications without external components, assuming that the source voltage has very low impedance and reasonable input voltage regulation. Since real-world voltage sources have finite impedance, performance is improved by adding external filter components. Sometimes only a small ceramic capacitor is sufficient. Since it is difficult to totally characterize all applications, some experimentation may be needed. Note that external input capacitors must accept high speed switching currents.

Because of the switching nature of DC/DC converters, the input of these converters must be driven from a source with both low AC impedance and adequate DC input regulation. Performance will degrade with increasing input inductance. Excessive input inductance may inhibit operation. The DC input regulation specifies that the input voltage, once operating, must never degrade below the Shut-Down Threshold under all load conditions. Be sure to use adequate trace sizes and mount components close to the converter.

I/O Filtering, Input Ripple Current and Output Noise

All models in this converter series are tested and specified for input reflected ripple current and output noise using designated external input/output components, circuits and layout as shown in the figures below. External input capacitors (C_{in} in the figure) serve primarily as energy storage elements, minimizing line voltage variations caused by transient IR drops in the input conductors. Users should select input capacitors for bulk capacitance (at appropriate frequencies), low ESR and high RMS ripple current ratings. In the figure below, the C_{BUS} and L_{BUS} components simulate a typical DC voltage bus. Your specific system configuration may require additional considerations. Please note that the values of C_{in} , L_{BUS} and C_{BUS} may vary according to the specific converter model.

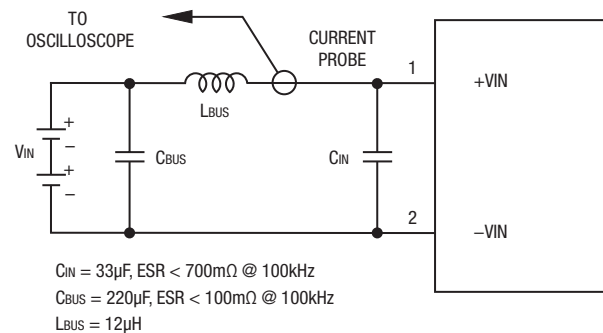

Figure 1. Measuring Input Ripple Current

In critical applications, output ripple and noise (also referred to as periodic and random deviations or PARD) may be reduced by adding filter elements such as multiple external capacitors. Be sure to calculate component temperature rise from reflected AC current dissipated inside capacitor ESR.

Floating Outputs

Since these are isolated DC/DC converters, their outputs are “floating” with respect to their input. The essential feature of such isolation is ideal ZERO CURRENT FLOW between input and output. Real-world converters however do exhibit tiny leakage currents between input and output (see Specifications). These leakages consist of both an AC stray capacitance coupling component and a DC leakage resistance. When using the isolation feature, do not allow the isolation voltage to exceed specifications. Otherwise the converter may be damaged. Designers will normally use the negative output (-Output) as the ground return of the load circuit. You can however use the positive output (+Output) as the ground return to effectively reverse the output polarity.

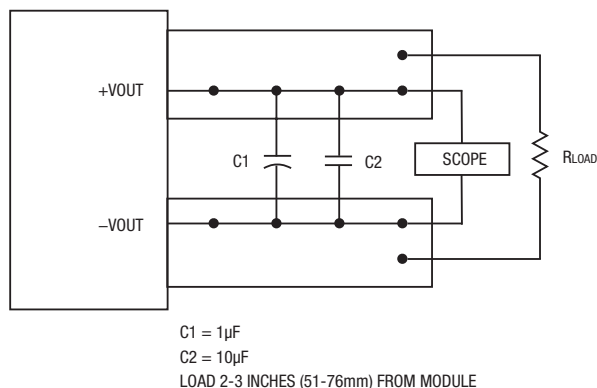

Figure 2. Measuring Output Ripple and Noise (PARD)

Minimum Output Loading Requirements

These converters employ a synchronous rectifier design topology. All models regulate within specification and are stable from 0% load to full load conditions, unless otherwise specified. Operation under no load will not damage the converter but might, however, slightly increase regulation, output ripple, and noise.

Thermal Shutdown

To protect against thermal over-stress, these converters include thermal shutdown circuitry. If environmental conditions cause the temperature of the DC/DC's to rise above the Operating Temperature Range up to the shutdown temperature, an on-board electronic temperature sensor will power down the unit. When the temperature decreases below the turn-on threshold, the converter will automatically restart. There is a small amount of hysteresis to prevent rapid on/off cycling. CAUTION: If you operate too close to the thermal limits, the converter may shut down suddenly without warning. Be sure to thoroughly test your application to avoid unplanned thermal shutdown.

Temperature Derating Curves

The graphs in the performance data section illustrate typical operation under a variety of conditions. The Derating curves show the maximum continuous ambient air temperature and decreasing maximum output current which is acceptable under increasing forced airflow measured in Linear Feet per Minute ("LFM"). Note that these are AVERAGE measurements. The converter will accept brief increases in temperature and/or current or reduced airflow as long as the average is not exceeded.

Note that the temperatures are of the ambient airflow, not the converter itself which is obviously running at higher temperature than the outside air. Also note that "natural convection" is defined as very low flow rates which are not using fan-forced airflow. Depending on the application, "natural convection" is usually about 30-65 LFM but is not equal to still air (0 LFM).

Murata Power Solutions makes Characterization measurements in a closed cycle wind tunnel with calibrated airflow. We use both thermocouples and an infrared camera system to observe thermal performance. As a practical matter, it is quite difficult to insert an anemometer to precisely measure airflow in most applications. Sometimes it is possible to estimate the effective airflow if you thoroughly understand the enclosure geometry, entry/exit orifice areas and the fan flowrate specifications.

CAUTION: If you exceed these Derating guidelines, the converter may have an unplanned Over Temperature shut down. Also, these graphs are all collected near Sea Level altitude. Be sure to reduce the derating for higher altitude.

Output Overvoltage Protection (OVP)

This converter monitors its output voltage for an over-voltage condition using an on-board electronic comparator. The signal is optically coupled to the primary side PWM controller. If the output exceeds OVP limits, the sensing circuit will power down the unit, and the output voltage will decrease. After a time-out period, the PWM will automatically attempt to restart, causing the output voltage to ramp up to its rated value. It is not necessary to power down and reset the converter for this automatic OVP-recovery restart.

If the fault condition persists and the output voltage climbs to excessive levels, the OVP circuitry will initiate another shutdown cycle. This on/off cycling is referred to as "hiccup" mode.

Output Fusing

The converter is extensively protected against current, voltage and temperature extremes. However, your application circuit may need additional protection. In the extremely unlikely event of output circuit failure, excessive voltage could be applied to your circuit. Consider using an appropriate external protection.

Output Current Limiting

As soon as the output current increases to approximately its overcurrent limit, the DC/DC converter will enter a current-limiting mode. The output voltage will decrease proportionally with increases in output current, thereby maintaining a somewhat constant power output. This is commonly referred to as power limiting.

Current limiting inception is defined as the point at which full power falls below the rated tolerance. See the Performance/Functional Specifications. Note particularly that the output current may briefly rise above its rated value. This enhances reliability and continued operation of your application. If the output current is too high, the converter will enter the short circuit condition.

Output Short Circuit Condition

When a converter is in current-limit mode, the output voltage will drop as the output current demand increases. If the output voltage drops too low, the magnetically coupled voltage used to develop PWM bias voltage will also drop, thereby shutting down the PWM controller. Following a time-out period, the PWM will restart, causing the output voltage to begin rising to its appropriate value. If the short-circuit condition persists, another shutdown cycle will initiate. This on/off cycling is called "hiccup mode." The hiccup cycling reduces the average output current, thereby preventing excessive internal temperatures.

Trimming the Output Voltage

The Trim input to the converter allows the user to adjust the output voltage over the rated trim range (please refer to the Specifications). In the trim equations and circuit diagrams that follow, trim adjustments use a single fixed resistor connected between the Trim input and either Vout pin. Trimming resistors should have a low temperature coefficient (± 100 ppm/ $^{\circ}$ C or less) and be mounted close to the converter. Keep leads short. If the trim function is not used, leave the trim unconnected. With no trim, the converter will exhibit its specified output voltage accuracy.

There are two CAUTIONs to observe for the Trim input:

CAUTION: To avoid unplanned power down cycles, do not exceed EITHER the maximum output voltage OR the maximum output power when setting the trim. If the output voltage is excessive, the OVP circuit may inadvertently shut down the converter. If the maximum power is exceeded, the converter may

enter current limiting. If the power is exceeded for an extended period, the converter may overheat and encounter overtemperature shut down.

CAUTION: Be careful of external electrical noise. The Trim input is a sensitive input to the converter's feedback control loop. Excessive electrical noise may cause instability or oscillation. Keep external connections short to the Trim input. Use shielding if needed.

Trim Equations

Trim Up

<Connect trim resistor between Trim and -Vout>

Trim Down

<Connect trim resistor between Trim and +Vout>

SPM15-033-Q12, Q48	
$R_{TUP} (\Omega) = \frac{12775}{V_o - 3.3} - 2050$	$R_{TDOWN} (\Omega) = \frac{5110 (V_o - 2.5)}{3.3 - V_o} - 2050$
SPM15-050-Q12, Q48	
$R_{TUP} (\Omega) = \frac{12775}{V_o - 5} - 2050$	$R_{TDOWN} (\Omega) = \frac{5110 \times (V_o - 2.5)}{5 - V_o} - 2050$
SPM15-120-Q12, Q48	
$R_{TUP} (\Omega) = \frac{25000}{V_o - 12} - 5110$	$R_{TDOWN} (\Omega) = \frac{10000 (V_o - 2.5)}{12 - V_o} - 5110$
SPM15-150-Q12, Q48	
$R_{TUP} (\Omega) = \frac{25000}{V_o - 15} - 5110$	$R_{TDOWN} (\Omega) = \frac{10000 (V_o - 2.5)}{15 - V_o} - 5110$

Where V_o = Desired output voltage. Adjustment accuracy is subject to resistor tolerances and factory-adjusted output accuracy. Mount trim resistor close to converter. Use short leads.

Remote On/Off Control

On the input side, a remote On/Off Control can be specified with either positive or negative logic as follows:

Positive: Models equipped with Positive Logic are enabled when the On/Off pin is left open or is pulled high to +15V_{DC} with respect to -V_{IN}. An internal bias current causes the open pin to rise to +V_{IN}. Positive-logic devices are disabled when the On/Off is grounded or brought to within a low voltage (see Specifications) with respect to -V_{IN}.

Negative: Models with negative logic are on (enabled) when the On/Off is grounded or brought to within a low voltage (see Specifications) with respect to -V_{IN}. The device is off (disabled) when the On/Off is left open or is pulled high to +15V_{DC} Max. with respect to -V_{IN}.

Dynamic control of the On/Off function should be able to sink the specified signal current when brought low and withstand specified voltage when brought high. Be aware too that there is a finite time in milliseconds (see Specifications) between the time of On/Off Control activation and stable, regulated output. This time will vary slightly with output load type and current and input conditions.

There are two CAUTIONs for the On/Off Control:

CAUTION: While it is possible to control the On/Off with external logic if you carefully observe the voltage levels, the preferred circuit is either an open drain/open collector transistor or a relay (which can thereupon be controlled by logic). The On/Off prefers to be set at approx. +15V (open pin) for the ON state, assuming positive logic.

CAUTION: Do not apply voltages to the On/Off pin when there is no input power voltage. Otherwise the converter may be permanently damaged.

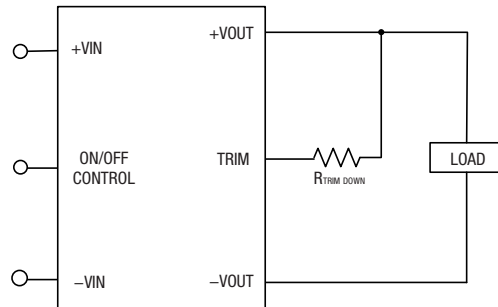

Figure 3. Trim adjustments to decrease Output Voltage using a Fixed Resistor

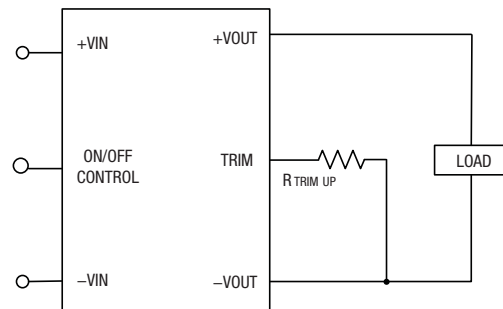

Figure 4. Trim adjustments to increase Output Voltage using a Fixed Resistor

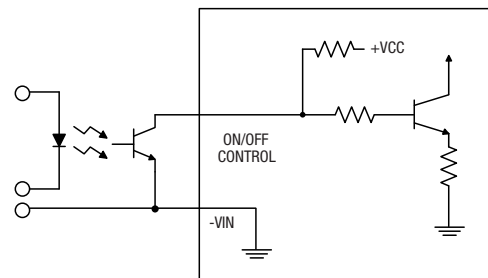

Figure 5. Driving the On/Off Control Pin (suggested circuit)

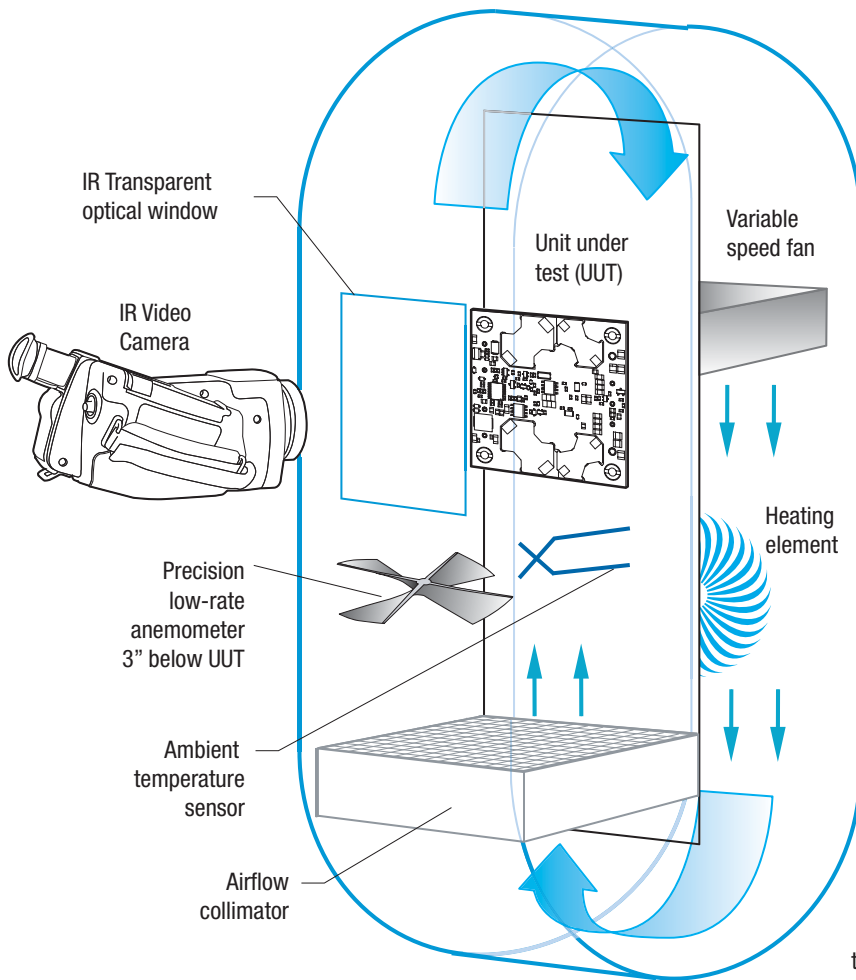

Figure 6. Vertical Wind Tunnel

Vertical Wind Tunnel

Murata Power Solutions employs a computer controlled custom-designed closed loop vertical wind tunnel, infrared video camera system, and test instrumentation for accurate airflow and heat dissipation analysis of power products. The system includes a precision low flow-rate anemometer, variable speed fan, power supply input and load controls, temperature gauges, and adjustable heating element.

The IR camera monitors the thermal performance of the Unit Under Test (UUT) under static steady-state conditions. A special optical port is used which is transparent to infrared wavelengths.

Both through-hole and surface mount converters are soldered down to a 10" X10" host carrier board for realistic heat absorption and spreading. Both longitudinal and transverse airflow studies are possible by rotation of this carrier board since there are often significant differences in the heat dissipation in the two airflow directions. The combination of adjustable airflow, adjustable ambient heat, and adjustable Input/Output currents and voltages mean that a very wide range of measurement conditions can be studied.

The collimator reduces the amount of turbulence adjacent to the UUT by minimizing airflow turbulence. Such turbulence influences the effective heat transfer characteristics and gives false readings. Excess turbulence removes more heat from some surfaces and less heat from others, possibly causing uneven overheating.

Both sides of the UUT are studied since there are different thermal gradients on each side. The adjustable heating element and fan, built-in temperature gauges, and no-contact IR camera mean that power supplies are tested in real-world conditions.

Soldering Guidelines

Murata Power Solutions recommends the specifications below when installing these converters. These specifications vary depending on the solder type. Exceeding these specifications may cause damage to the product. Be cautious when there is high atmospheric humidity. We strongly recommend a mild pre-bake (100° C. for 30 minutes). Your production environment may differ; therefore please thoroughly review these guidelines with your process engineers.

Wave Solder Operations for through-hole mounted products (THMT)			
For Sn/Ag/Cu based solders:		For Sn/Pb based solders:	
Maximum Preheat Temperature	115° C.	Maximum Preheat Temperature	105° C.
Maximum Pot Temperature	270° C.	Maximum Pot Temperature	250° C.
Maximum Solder Dwell Time	7 seconds	Maximum Solder Dwell Time	6 seconds

Murata Power Solutions, Inc.
11 Cabot Boulevard, Mansfield, MA 02048-1151 U.S.A.
ISO 9001 and 14001 REGISTERED



**This product is subject to the following operating requirements and the Life and Safety Critical Application Sales Policy:
Refer to: <http://www.murata-ps.com/requirements/>**

Murata Power Solutions, Inc. makes no representation that the use of its products in the circuits described herein, or the use of other technical information contained herein, will not infringe upon existing or future patent rights. The descriptions contained herein do not imply the granting of licenses to make, use, or sell equipment constructed in accordance therewith. Specifications are subject to change without notice. © 2014 Murata Power Solutions, Inc.



Компания «ЭлектроПласт» предлагает заключение долгосрочных отношений при поставках импортных электронных компонентов на взаимовыгодных условиях!

Наши преимущества:

- Оперативные поставки широкого спектра электронных компонентов отечественного и импортного производства напрямую от производителей и с крупнейших мировых складов;
- Поставка более 17-ти миллионов наименований электронных компонентов;
- Поставка сложных, дефицитных, либо снятых с производства позиций;
- Оперативные сроки поставки под заказ (от 5 рабочих дней);
- Экспресс доставка в любую точку России;
- Техническая поддержка проекта, помощь в подборе аналогов, поставка прототипов;
- Система менеджмента качества сертифицирована по Международному стандарту ISO 9001;
- Лицензия ФСБ на осуществление работ с использованием сведений, составляющих государственную тайну;
- Поставка специализированных компонентов (Xilinx, Altera, Analog Devices, Intersil, Interpoint, Microsemi, Aeroflex, Peregrine, Syfer, Eurofarad, Texas Instrument, Miteq, Cobham, E2V, MA-COM, Hittite, Mini-Circuits, General Dynamics и др.);

Помимо этого, одним из направлений компании «ЭлектроПласт» является направление «Источники питания». Мы предлагаем Вам помощь Конструкторского отдела:

- Подбор оптимального решения, техническое обоснование при выборе компонента;
- Подбор аналогов;
- Консультации по применению компонента;
- Поставка образцов и прототипов;
- Техническая поддержка проекта;
- Защита от снятия компонента с производства.



Как с нами связаться

Телефон: 8 (812) 309 58 32 (многоканальный)

Факс: 8 (812) 320-02-42

Электронная почта: org@eplast1.ru

Адрес: 198099, г. Санкт-Петербург, ул. Калинина, дом 2, корпус 4, литера А.