



±15kV ESD-Protected, 460kbps, 1μA, RS-232-Compatible Transceivers in μMAX

General Description

The MAX3311E/MAX3313E are low-power, 5V EIA/TIA-232-compatible transceivers. All transmitter outputs and receiver inputs are protected to ±15kV using the Human Body Model, making these devices ideal for applications where more robust transceivers are required.

Both devices have one transmitter and one receiver. The transmitters have a proprietary low-dropout transmitter output stage enabling RS-232-compatible operation from a +5V supply with a single inverting charge pump. These transceivers require only three 0.1μF capacitors and will run at data rates up to 460kbps while maintaining RS-232-compatible output levels.

The MAX3311E features a 1μA shutdown mode. In shutdown the device turns off the charge pump, pulls V- to ground, and the transmitter output is disabled. The MAX3313E features an INVALID output that asserts high when an active RS-232 cable signal is connected, signaling to the host that a peripheral is connected to the communication port.

Applications

Digital Cameras
PDAs
GPS
POS
Telecommunications
Handy Terminals
Set-Top Boxes

Pin Configurations



Features

- ◆ ESD Protection for RS-232-Compatible I/O Pins ±15kV—Human Body Model
- ◆ 1μA Low-Power Shutdown (MAX3311E)
- ◆ INVALID Output (MAX3313E)
- ◆ Receiver Active in Shutdown (MAX3311E)
- ◆ Single Transceiver (1Tx/1Rx) in 10-Pin μMAX Package

Ordering Information

PART	TEMP. RANGE	PIN-PACKAGE
MAX3311ECUB	0°C to +70°C	10 μMAX
MAX3311EEUB	-40°C to +85°C	10 μMAX
MAX3313ECUB	0°C to +70°C	10 μMAX
MAX3313EEUB	-40°C to +85°C	10 μMAX

Typical Operating Circuit



MAX3311E/MAX3313E

±15kV ESD-Protected, 460kbps, 1μA, RS-232-Compatible Transceivers in μMAX

ABSOLUTE MAXIMUM RATINGS

V _{CC} to GND	-0.3V to +6V	Continuous Power Dissipation	
V ₋ to GND	+0.3V to -7V	10-Pin μMAX (derate 5.6mW/°C above +70°C)	444mW
V _{CC} + V ₋	+13V	Operating Temperature Ranges	
Input Voltages		MAX331_ECUB	0°C to +70°C
T _{IN} , $\overline{\text{SHDN}}$ to GND	-0.3V to +6V	MAX331_EEUB	-40°C to +85°C
R _{IN} to GND	±25V	Junction Temperature	+150°C
Output Voltages		Storage Temperature Range	-65°C to +150°C
T _{OUT} to GND	±13.2V	Lead Temperature (soldering, 10s)	+300°C
R _{OUT} , $\overline{\text{INVALID}}$ to GND	-0.3V to (V _{CC} + 0.3V)		
Short-Circuit Duration			
T _{OUT} to GND	Continuous		

Stresses beyond those listed under "Absolute Maximum Ratings" may cause permanent damage to the device. These are stress ratings only, and functional operation of the device at these or any other conditions beyond those indicated in the operational sections of the specifications is not implied. Exposure to absolute maximum rating conditions for extended periods may affect device reliability.

ELECTRICAL CHARACTERISTICS

(V_{CC} = +5V, C1 and C2 = 0.1μF, T_A = T_{MIN} to T_{MAX}. Typical values are at T_A = +25°C.)

PARAMETER	SYMBOL	CONDITIONS	MIN	TYP	MAX	UNITS
DC CHARACTERISTICS						
Supply Operation Range	V _{CC}		4.5	5	5.5	V
Supply Current		$\overline{\text{SHDN}} = \text{V}_{\text{CC}}$, no load		100	250	μA
Shutdown Supply Current		$\overline{\text{SHDN}} = \text{GND}$ (MAX3311E only)		1	10	μA
LOGIC INPUTS (T_{IN}, $\overline{\text{SHDN}}$)						
Input Logic Threshold Low	V _{IL}		0.8			V
Input Logic Threshold High	V _{IH}				2.4	V
Transmitter Input Hysteresis				0.5		V
Input Leakage Current				±0.01	±1	μA
RECEIVER OUTPUT						
Output Voltage Low	V _{OL}	I _{OUT} = 1.6mA			0.4	V
Output Voltage High	V _{OH}	I _{OUT} = -1.0mA	V _{CC} - 0.6	V _{CC} - 0.1		V
$\overline{\text{INVALID}}$ OUTPUT (MAX3313E only)						
Receiver Input Threshold to $\overline{\text{INVALID}}$ Output High		Figure 7, positive threshold			2.7	V
		Figure 7, negative threshold	-2.7			
Receiver Input Threshold to $\overline{\text{INVALID}}$ Output Low		Figure 7	-0.3		0.3	V
$\overline{\text{INVALID}}$ Output Low	V _{OL}	I _{OUT} = 1.6mA			0.4	V
$\overline{\text{INVALID}}$ Output High	V _{OH}	I _{OUT} = -1.0mA	V _{CC} - 0.6			V
Receiver Positive or Negative Thresholds to $\overline{\text{INVALID}}$ High		Figure 7		0.1		μs
Receiver Positive or Negative Threshold to $\overline{\text{INVALID}}$ Low		Figure 7		30		μs

±15kV ESD-Protected, 460kbps, 1μA, RS-232-Compatible Transceivers in μMAX

MAX3311E/MAX3313E

ELECTRICAL CHARACTERISTICS (continued)

(V_{CC} = +5V, C1 and C2 = 0.1μF, T_A = T_{MIN} to T_{MAX}. Typical values are at T_A = +25°C.)

PARAMETER	SYMBOL	CONDITIONS	MIN	TYP	MAX	UNITS
RECEIVER INPUT						
Input Threshold Low	V _{IL}		0.8			V
Input Threshold High	V _{IH}				2.4	V
Input Hysteresis				0.5		V
Input Resistance				5		kΩ
TRANSMITTER OUTPUT						
Output Voltage Swing		Transmitter output loaded with 3kΩ to	±3.7			V
Output Resistance (Note 1)		V _{CC} = 0, transmitter output = ±2V	300			Ω
Output Short-Circuit Current					±60	mA
Output Leakage Current		V _{OUT} = ±12V, transmitter disabled			±25	μA
ESD PERFORMANCE (TRANSMITTER OUTPUT, RECEIVER INPUT)						
ESD-Protection Voltage		Human Body Model		±15		kV

Note 1: Not tested—guaranteed by design.

TIMING CHARACTERISTICS

(V_{CC} = +5V, C1 and C2 = 0.1μF, T_A = T_{MIN} to T_{MAX}. Typical values are at T_A = +25°C.)

PARAMETER	SYMBOL	CONDITIONS	MIN	TYP	MAX	UNITS
Maximum Data Rate		R _L = 3kΩ, C _L = 1000pF	460			kbps
Receiver Propagation Delay	t _{PLH} /t _{PHL}	Receiver input to receiver output, C _L = 150pF		0.15		μs
Transmitter Skew				100		ns
Receiver Skew				50		ns
Transition Region Slew Rate		R _L = 3kΩ to 7kΩ, C _L = 150pF to 1000pF, measured from +3V to -3V or from -3V to +3V		11		V/μs

±15kV ESD-Protected, 460kbps, 1μA, RS-232-Compatible Transceivers in μMAX

Typical Operating Characteristics

(V_{CC} = +5V, 0.1μF capacitors, transmitter loaded with 3kΩ and C_L, T_A = +25°C, unless otherwise noted.)

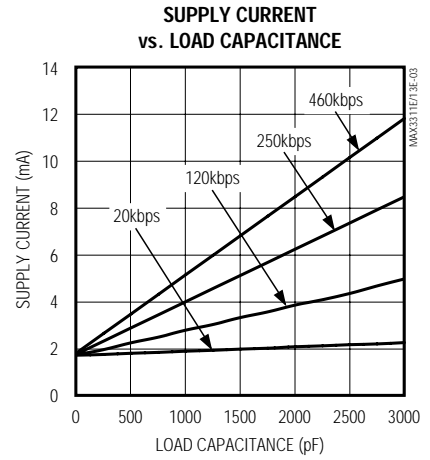
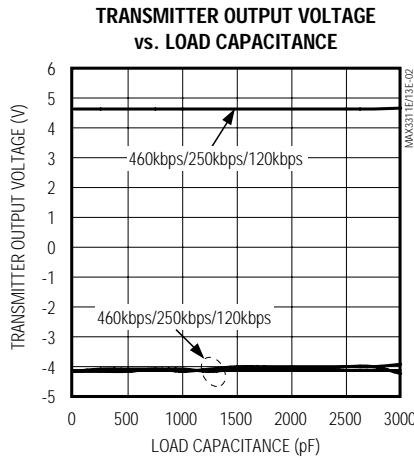

Pin Description

PIN		NAME	FUNCTION
MAX3311E	MAX3313E		
1	1	V _{CC}	+5V External Power Supply. Decouple with a 0.1μF capacitor to ground.
2	2	C1-	Negative Terminal of the Voltage Inverter Charge-Pump Capacitor
3	—	$\overline{\text{SHDN}}$	Shutdown Active Low (0 = off, 1 = on)
—	3	$\overline{\text{INVALID}}$	Valid Signal Detector Output, Active Low. A logic high indicates that a valid RS-232 level is present on the receiver input.
4	4	TIN	TTL/CMOS Transmitter input
5	5	ROUT	TTL/CMOS Receiver output
6	6	RIN	±15kV ESD-Protected, RS-232 Receiver Input
7	7	TOUT	±15kV ESD-Protected, RS-232-Compatible Transmitter Output
8	8	V-	-4.3V generated by the charge pump. Connect a 0.1μF capacitor to ground.
9	9	C1+	Positive Terminal of the Voltage Inverter Charge-Pump Capacitor
10	10	GND	Ground

±15kV ESD-Protected, 460kbps, 1μA, RS-232-Compatible Transceivers in μMAX

MAX3311E/MAX3313E

Detailed Description

Single Charge-Pump Voltage Converter

The MAX3311E/MAX3313E internal power supply has a single inverting charge pump that provides a negative voltage from a single +5V supply. The charge pump operates in a discontinuous mode and requires a flying capacitor (C1) and a reservoir capacitor (C2) to generate the V- supply.

RS-232-Compatible Driver

The transmitter is an inverting level translator that converts CMOS-logic levels to EIA/TIA-232 compatible levels. It guarantees data rates up to 460kbps with worst-case loads of 3kΩ in parallel with 1000pF. When SHDN is driven low, the transmitter is disabled and put into tri-state. The transmitter input does not have an internal pullup resistor.

RS-232 Receiver

The MAX3311E/MAX3313E receiver converts RS-232 signals to CMOS-logic output levels. The MAX3311E receiver will remain active during shutdown mode. The MAX3313E INVALID indicates when an RS-232 signal is present at the receiver input, and therefore when the port is in use.

The MAX3313E INVALID output is pulled low when no valid RS-232 signal level is detected on the receiver input.

MAX3311E Shutdown Mode

In shutdown mode, the charge pump is turned off, V- is pulled to ground, and the transmitter output is disabled (Table 1). This reduces supply current typically to 1μA. The time required to exit shutdown is less than 25ms.

Applications Information

Capacitor Selection

The capacitor type used for C1 and C2 is not critical for proper operation; either polarized or nonpolarized capacitors are acceptable. If polarized capacitors are used, connect polarity as shown in the *Typical Operating Circuit*. The charge pump requires 0.1μF capacitors. Increasing the capacitor values (e.g., by a factor of 2) reduces power consumption. C2 can be

increased without changing C1's value. However, do not increase C1's value without also increasing the value of C2 and CBYPASS to maintain the proper ratios (C1 to the other capacitors).

When using the minimum 0.1μF capacitors, make sure the capacitance does not degrade excessively with temperature. If in doubt, use capacitors with a larger nominal value. The capacitor's equivalent series resistance (ESR) usually rises at low temperatures and influences the amount of ripple on V-.

To reduce the output impedance at V-, use larger capacitors (up to 10μF).

Bypass VCC to ground with at least 0.1μF. In applications sensitive to power-supply noise generated by the charge pump, decouple VCC to ground with a capacitor the same size as (or larger than) charge-pump capacitors C1 and C2.

Transmitter Output when Exiting Shutdown

Figure 1 shows the transmitter output when exiting shutdown mode. The transmitter is loaded with 3kΩ in parallel with 1000pF. The transmitter output displays no ringing or undesirable transients as the MAX3311E comes out of shutdown. Note that the transmitter is enabled only when the magnitude of V- exceeds approximately -3V.

High Data Rates

The MAX3311E/MAX3313E maintain RS-232-compatible ±3.7V minimum transmitter output voltage even at

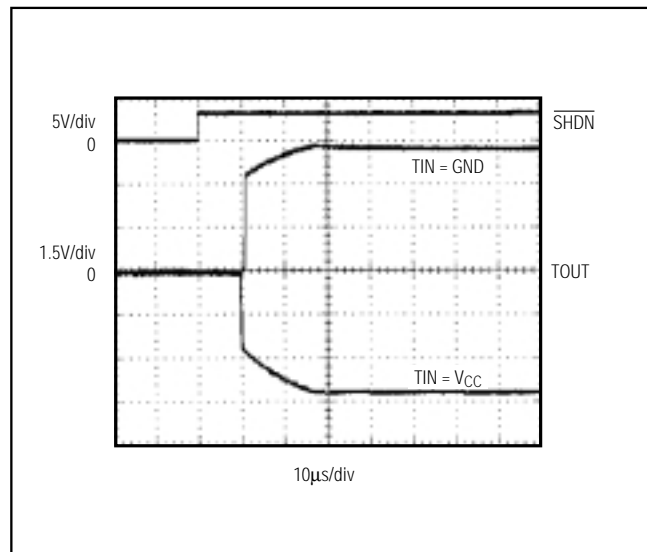

Figure 1. Transmitter Output when Exiting Shutdown or Powering Up

Table 1. MAX3311E Shutdown Logic Truth Table

SHDN	TRANSMITTER OUTPUT	RECEIVER OUTPUT	CHARGE PUMP
L	High Z	Active	Inactive
H	Active	Active	Active

$\pm 15\text{kV}$ ESD-Protected, 460kbps, $1\mu\text{A}$, RS-232-Compatible Transceivers in μMAX

high data rates. Figure 2 shows a transmitter loopback test circuit. Figure 3 shows the loopback test result at 120kbps, and Figure 4 shows the same test at 250kbps.

$\pm 15\text{kV}$ ESD Protection

As with all Maxim devices, ESD-protection structures are incorporated on all pins to protect against electrostatic discharges encountered during handling and assembly. The MAX3311E/MAX3313E driver outputs

and receiver inputs have extra protection against static discharge. Maxim's engineers have developed state-of-the-art structures to protect these pins against ESD of $\pm 15\text{kV}$ without damage. The ESD structures withstand high ESD in all states: normal operation, shutdown, and powered down. After an ESD event, Maxim's E versions keep working without latchup; whereas, competing products can latch and must be powered down to remove latchup.

ESD protection can be tested in various ways. The transmitter outputs and receiver inputs of the product family are characterized for protection to $\pm 15\text{kV}$ using the Human Body Model.

ESD Test Conditions

ESD performance depends on a variety of conditions. Contact Maxim for a reliability report that documents test setup, test methodology, and test results.

Human Body Model

Figure 5 shows the Human Body Model, and Figure 6 shows the current waveform it generates when discharged into low impedance. This model consists of a 100pF capacitor charged to the ESD voltage of interest, which is then discharged into the test device through a $1.5\text{k}\Omega$ resistor.

Machine Model

The Machine Model for ESD tests all pins using a 200pF storage capacitor and zero discharge resistance. Its objective is to emulate the stress caused by contact that occurs with handling and assembly during manufacturing. Of course, all pins require this protection during manufacturing, not just RS-232 inputs and outputs. Therefore, after PC board assembly, the Machine Model is less relevant to I/O ports.

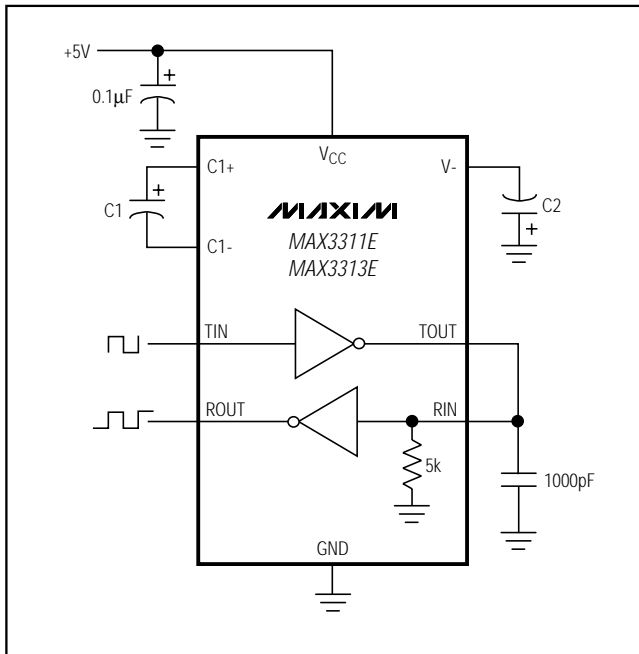

Figure 2. Loopback Test Circuit

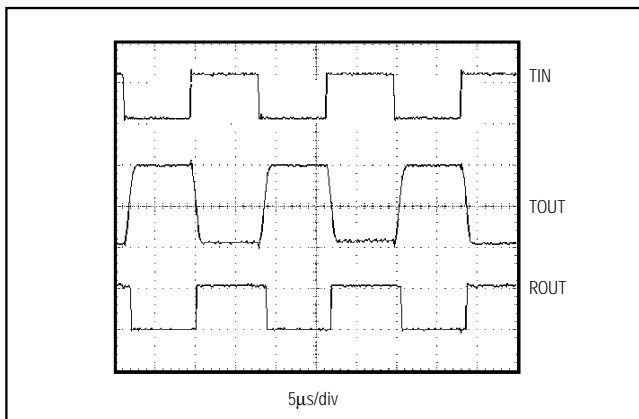

Figure 3. Loopback Test Results at 120kbps

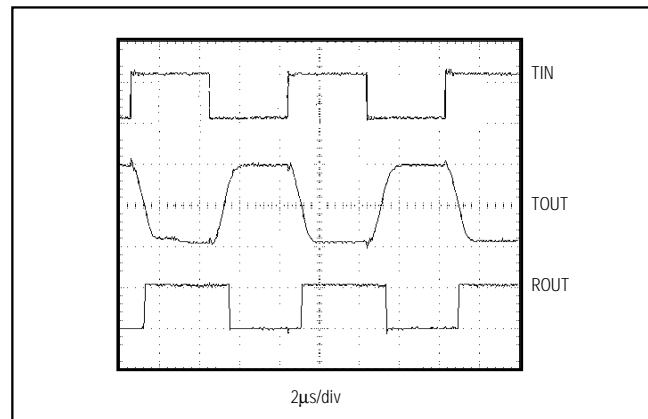

Figure 4. Loopback Test Results at 250kbps

±15kV ESD-Protected, 460kbps, 1μA, RS-232-Compatible Transceivers in μMAX

MAX3311E/MAX3313E



Figure 5. Human Body ESD Test Model

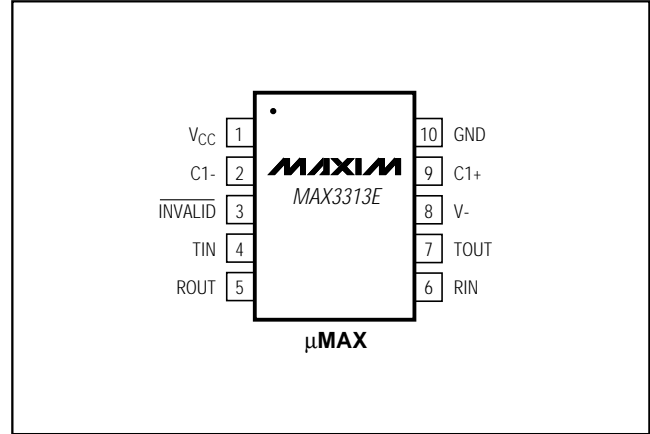

Figure 6. Human Body Current Waveform



Figure 7. Receiver Positive/Negative Thresholds for $\overline{\text{INVALID}}$

Pin Configurations (continued)



Chip Information
TRANSISTOR COUNT: 278

±15kV ESD-Protected, 460kbps, 1µA, RS-232-Compatible Transceivers in µMAX

Pin Description



TOLUMAX.EPS

Maxim cannot assume responsibility for use of any circuitry other than circuitry entirely embodied in a Maxim product. No circuit patent licenses are implied. Maxim reserves the right to change the circuitry and specifications without notice at any time.

8 _____ Maxim Integrated Products, 120 San Gabriel Drive, Sunnyvale, CA 94086 408-737-7600



Компания «ЭлектроПласт» предлагает заключение долгосрочных отношений при поставках импортных электронных компонентов на взаимовыгодных условиях!

Наши преимущества:

- Оперативные поставки широкого спектра электронных компонентов отечественного и импортного производства напрямую от производителей и с крупнейших мировых складов;
- Поставка более 17-ти миллионов наименований электронных компонентов;
- Поставка сложных, дефицитных, либо снятых с производства позиций;
- Оперативные сроки поставки под заказ (от 5 рабочих дней);
- Экспресс доставка в любую точку России;
- Техническая поддержка проекта, помощь в подборе аналогов, поставка прототипов;
- Система менеджмента качества сертифицирована по Международному стандарту ISO 9001;
- Лицензия ФСБ на осуществление работ с использованием сведений, составляющих государственную тайну;
- Поставка специализированных компонентов (Xilinx, Altera, Analog Devices, Intersil, Interpoint, Microsemi, Aeroflex, Peregrine, Syfer, Eurofarad, Texas Instrument, Miteq, Cobham, E2V, MA-COM, Hittite, Mini-Circuits, General Dynamics и др.);

Помимо этого, одним из направлений компании «ЭлектроПласт» является направление «Источники питания». Мы предлагаем Вам помощь Конструкторского отдела:

- Подбор оптимального решения, техническое обоснование при выборе компонента;
- Подбор аналогов;
- Консультации по применению компонента;
- Поставка образцов и прототипов;
- Техническая поддержка проекта;
- Защита от снятия компонента с производства.



Как с нами связаться

Телефон: 8 (812) 309 58 32 (многоканальный)

Факс: 8 (812) 320-02-42

Электронная почта: org@eplast1.ru

Адрес: 198099, г. Санкт-Петербург, ул. Калинина, дом 2, корпус 4, литера А.