



### »» Features

- Heavy duty 30A 240VAC, 25A 240VAC power type.
- AC & DC coils are both available.
- PCB terminals and quick terminal types.
- Optional for special large contact gap 3.0mm version.  
SPNO-ST & DPNO-ST contact configuration.
- Comply with RoHS-Directive 2002/95/EC.

### »» Type List

Terminal style	Contact form	Enlarge spacing type	Designation			
			Dust cover	Flux tight	Flanged cover	Sealed type washable
S (Quick terminal)	1A (SPDM)	-----	841-S-1A-D	841-S-1A-C	841-S-1A-C1	841-S-1A-S
		H	841-S-1A-D-H	841-S-1A-C-H	841-S-1A-C1-H	841-S-1A-S-H
	2A (DPDM)	-----	841-S-2A-D	841-S-2A-C	841-S-2A-C1	841-S-2A-S
		H	841-S-2A-D-H	841-S-2A-C-H	841-S-2A-C1-H	841-S-2A-S-H
P (PCB terminal)	1A (SPDM)	-----	841-P-1A-D	841-P-1A-C	-----	841-P-1A-S
		H	841-P-1A-D-H	841-P-1A-C-H	-----	841-P-1A-S-H
	2A (DPDM)	-----	841-P-2A-D	841-P-2A-C	-----	841-P-2A-S
		H	841-P-2A-D-H	841-P-2A-C-H	-----	841-P-2A-S-H

### »» Ordering Information

841 - S - 1A - F - C - H  
 1        2        3        4        5        6

- |  |  |
|--|--|
| <p>1. 841 -- Basic series designation</p> <p>2. S -- Quick terminal<br/>P -- PCB terminals</p> <p>3. 1A -- Form A, single-pole, double-make (SPDM)<br/>2A -- Form A, double-pole, double-make (DPDM)</p> <p>4. Blank -- Standard type<br/>F -- Class F</p> | <p>5. C -- Flux tight<br/>D -- Dust cover<br/>V -- Sealed type<br/>S -- Sealed type washable<br/>C1 -- Flanged cover<br/>D1 -- Dust cover with flange<br/>S1 -- Plastic sealed washable with flange</p> <p>6. Blank -- Standard type<br/>H -- Enlarged insulation spacing type</p> |
|--|--|

### »» Contact Rating

Load type	1A (SPDM)	2A (DPDM)
Rated load (Resistive)	30A 220VAC	25A 220VAC
Max. Switching Current	30A	25A
Max. Switching Voltage	277VAC	277VAC
Max. Switching Capacity	6600VA	5500VA

## »» Coil Rating (DC)

Rated voltage (V)	Rated current $\pm 10\%$ at 23° C (mA)	Coil resistance $\pm 10\%$ at 23° C ( $\Omega$ )	Max. continuous voltage at 70° C	Pick up voltage(Max) at 23° C	Drop out voltage(Min) at 23° C	Power consumption at rated voltage
3	638	4.7	110 % of rated voltage	75 % of rated voltage	10 % of rated voltage	approx. 1.92W
6	319	18.8				
12	160	75				
24	80	300				
48/50	40/41.6	1200				
100	19.2	5200				
110	17.4	6300				
200	9.5	21000				

## »» Coil Rating (AC)

Rated voltage (V)	Rated current $+15/-20\%$ at 23° C (mA)	Coil resistance $+15/-20\%$ at 23° C ( $\Omega$ )	Max. continuous voltage at 70° C	Pick up voltage(Max) at 23° C	Drop out voltage(Min) at 23° C	Power consumption at rated voltage
6	275	15	110 % of rated voltage	80 % of rated voltage	10 % of rated voltage	approx. 1.7VA ~ 2.7VA
12	138	75				
24	74	300				
48/50	39/40	1,200				
100/120	18.7/22.1	5,200				
200/240	9.1/10.8	21,000				

## »» Specification

Contact material	AgSnO alloy	
Contact resistance <sup>(1)</sup>	100 m $\Omega$ Max.	
Operate time <sup>(1)</sup>	30 ms Max.	
Release time <sup>(1)</sup>	30 ms Max.	
Insulation resistance <sup>(1)</sup>	1000 M $\Omega$ Min. (DC 500V)	
Dielectric strength <sup>(1)</sup>	Between open contact	: AC 2000V , 50/60Hz 1 min.
	Between contact and coil	: AC 4000V , 50/60Hz 1 min.
	Between contact circuits	: AC 2000V , 50/60Hz 1 min.
Vibration resistance	Operating extremes	10~55Hz , amplitude 1.5 mm
	Damage limits	10~55Hz , amplitude 1.5 mm
Shock resistance	Operating extremes	10G
	Damage limits	100G

Life expectancy	Mechanical	5,000,000 operations (frequency 18,000 operations/hr)
	Electrical	100,000 operations (frequency 900 operations/hr)
Operating ambient temperature	-55~+70°C (no freezing)	
Weight	Approx. 90 g	

Note : (1) initial value.

### »» Safety Approval

Certified	UL / CUL	TUV
File No.	E88991	R9653713

### »» Safety Approval Rating

UL / CUL		TUV	
1A	2A	1A	2A
30A 277VAC TV-10 10A 277VAC 1.5HP 20FLA, 125VAC 3HP 14.1FLA, 277VAC	25A 277VAC TV-10 10A 277VAC 1HP 16FLA, 125VAC 2HP 9.96FLA, 277VAC	30A 250VAC 25A 250VAC $\cos\phi 0.4$ 30A 125VAC $\cos\phi 0.4$	25A 250VAC 25A 250VAC $\cos\phi 0.4$

### »» Outline Dimensions

#### ◆ 841-S-2A (C,D,V,S)

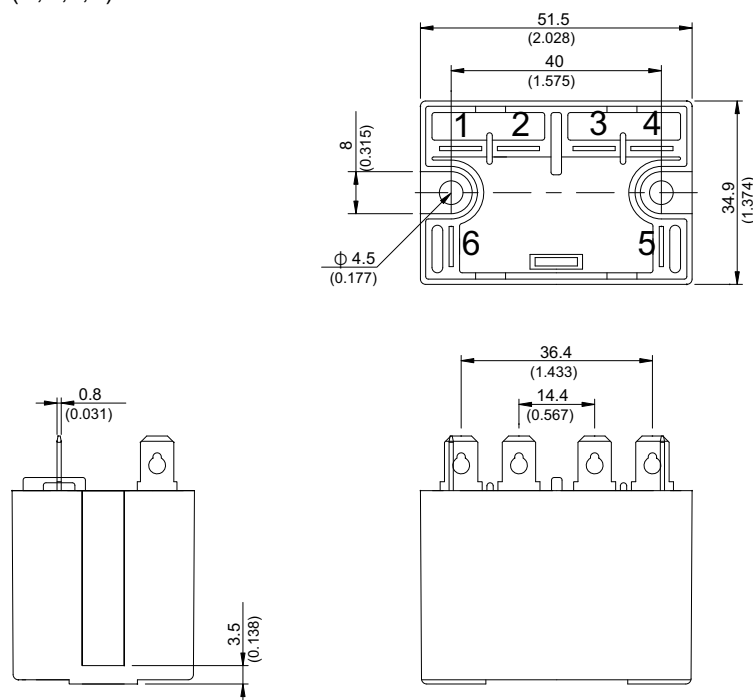

# 841

◆841-P-2A (C,D,V,S)



◆841-S-1A (C,D,V,S)

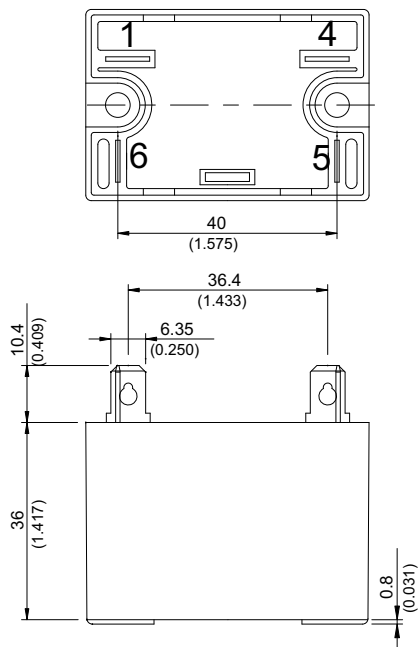

◆841-P-1A (C,D,V,S)



◆ 841-S-1A (C1,D1,S1)



◆ 841-S-2A (C1,D1,S1)

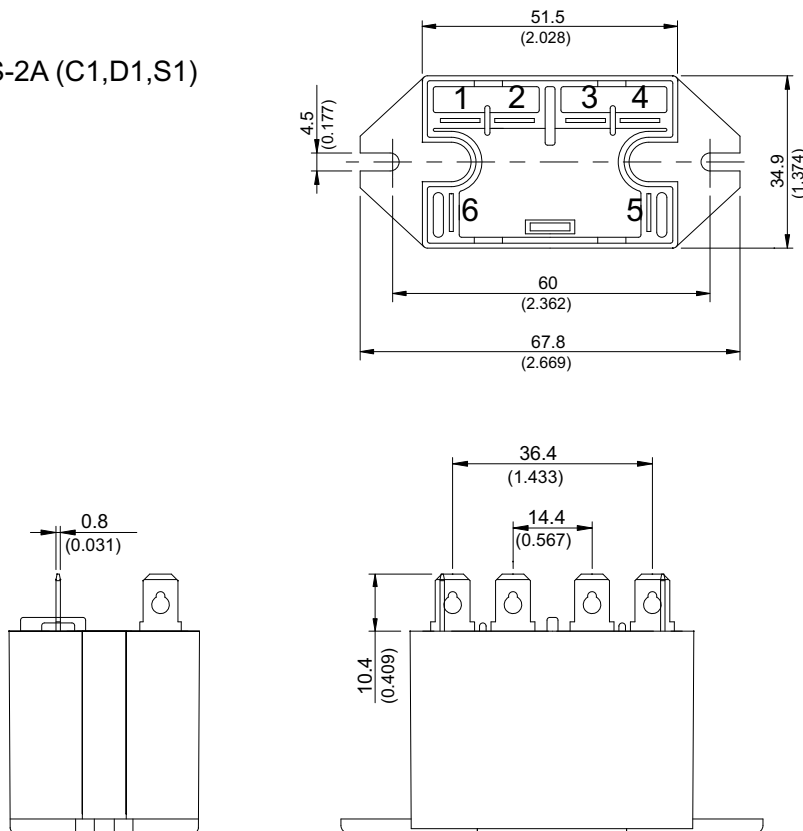

# 841

## »» Wiring Diagram BOTTOM VIEW

2A



1A

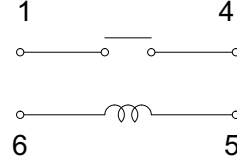

## »» Mounting Holes BOTTOM VIEW

◆841-S



◆841-S (C1,D1,S1)

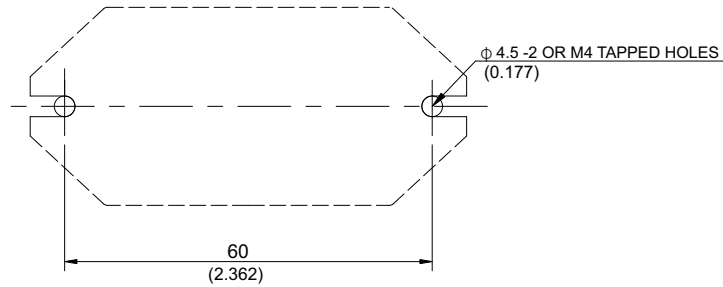

## »» PC Board Layout BOTTOM VIEW

◆841-P

2A



1A

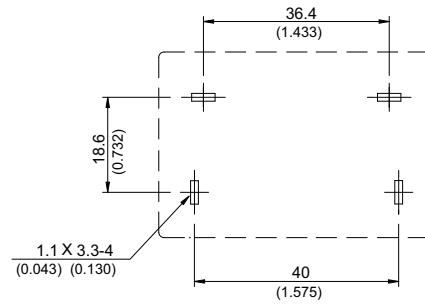

## »» Engineering Data

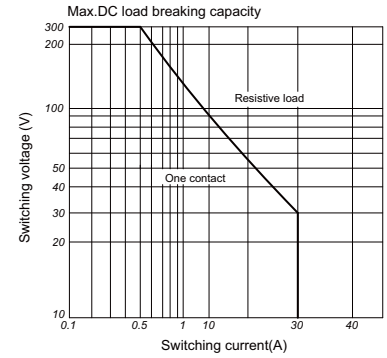

### ◆ 841(1P)

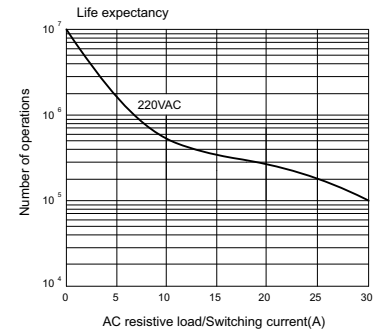

### ◆ 841(2P)

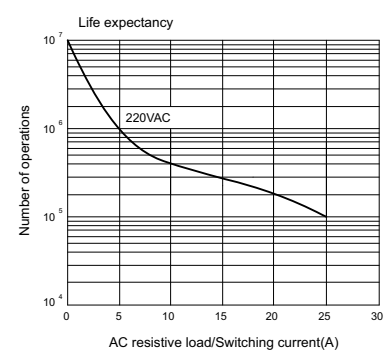



Компания «ЭлектроПласт» предлагает заключение долгосрочных отношений при поставках импортных электронных компонентов на взаимовыгодных условиях!

Наши преимущества:

- Оперативные поставки широкого спектра электронных компонентов отечественного и импортного производства напрямую от производителей и с крупнейших мировых складов;
- Поставка более 17-ти миллионов наименований электронных компонентов;
- Поставка сложных, дефицитных, либо снятых с производства позиций;
- Оперативные сроки поставки под заказ (от 5 рабочих дней);
- Экспресс доставка в любую точку России;
- Техническая поддержка проекта, помощь в подборе аналогов, поставка прототипов;
- Система менеджмента качества сертифицирована по Международному стандарту ISO 9001;
- Лицензия ФСБ на осуществление работ с использованием сведений, составляющих государственную тайну;
- Поставка специализированных компонентов (Xilinx, Altera, Analog Devices, Intersil, Interpoint, Microsemi, Aeroflex, Peregrine, Syfer, Eurofarad, Texas Instrument, Miteq, Cobham, E2V, MA-COM, Hittite, Mini-Circuits, General Dynamics и др.);

Помимо этого, одним из направлений компании «ЭлектроПласт» является направление «Источники питания». Мы предлагаем Вам помощь Конструкторского отдела:

- Подбор оптимального решения, техническое обоснование при выборе компонента;
- Подбор аналогов;
- Консультации по применению компонента;
- Поставка образцов и прототипов;
- Техническая поддержка проекта;
- Защита от снятия компонента с производства.



#### Как с нами связаться

**Телефон:** 8 (812) 309 58 32 (многоканальный)

**Факс:** 8 (812) 320-02-42

**Электронная почта:** [org@eplast1.ru](mailto:org@eplast1.ru)

**Адрес:** 198099, г. Санкт-Петербург, ул. Калинина, дом 2, корпус 4, литера А.