

SIOV metal oxide varistors

Leaded varistors, AdvanceD series

Series/Type: B722*

Date: January 2018

© EPCOS AG 2018. Reproduction, publication and dissemination of this publication, enclosures hereto and the information contained therein without EPCOS' prior express consent is prohibited.

EPCOS AG is a TDK Group Company.

Construction

- Round varistor element, leaded
- Coating: epoxy resin, flame-retardant to UL 94 V-0
- Terminals: tinned wire

Features

- High-energy AdvanceD series E2
- High surge current ratings up to 10 kA
- High energy ratings up to 440 J
- Wide operating voltage range 130 ... 680 V_{RMS}
- PSpice models

Approvals

- UL
- CSA
- VDE
- CQC S05/07 (K11 ... K460), S10/S14 (K11 ... K680), S20 (K11 ... K1000)
- IEC

Delivery mode

- Bulk (standard), taped versions on reel or in Ammo pack upon request.
- For further details refer to chapter "Taping, packaging and lead configuration" for leaded varistors.

General technical data

Climatic category	to IEC 60068-1	40/105/56	
Operating temperature	to IEC 61051	-40 ... +105	°C
Storage temperature		-40 ... +125	°C
Electric strength	to IEC 61051	≥ 2.5	kV _{RMS}
Insulation resistance	to IEC 61051	≥ 100	MΩ

Leaded varistors
B722*
AdvanceD series
Electrical specifications and ordering codes
Maximum ratings ($T_A = 105\text{ }^\circ\text{C}$)

Ordering code	Type (untaped) SIOV-	V_{RMS} V	V_{DC} V	i_{max} (8/20 μ s) 1 time A	I_n ¹⁾ (8/20 μ s) 15 times A	W_{max} (2 ms) J	P_{max} W
$V_{RMS} = 130\text{ V}$							
B72205S2131K101	S05K130E2	130	170	800	150	6.0	0.10
B72207S2131K101	S07K130E2	130	170	1750	500	12.5	0.25
B72210S2131K101	S10K130E2	130	170	3500	1500	25.0	0.40
B72214S2131K101	S14K130E2	130	170	6000	3000	50.0	0.60
B72220S2131K101	S20K130E2	130	170	10000	3000	100.0	1.00
$V_{RMS} = 140\text{ V}$							
B72205S2141K101	S05K140E2	140	180	800	150	6.5	0.10
B72207S2141K101	S07K140E2	140	180	1750	500	13.5	0.25
B72210S2141K101	S10K140E2	140	180	3500	1500	27.5	0.40
B72214S2141K101	S14K140E2	140	180	6000	3000	55.0	0.60
B72220S2141K101	S20K140E2	140	180	10000	3000	110.0	1.00
$V_{RMS} = 150\text{ V}$							
B72205S2151K101	S05K150E2	150	200	800	150	7.5	0.10
B72207S2151K101	S07K150E2	150	200	1750	500	15.0	0.25
B72210S2151K101	S10K150E2	150	200	3500	1500	30.0	0.40
B72214S2151K101	S14K150E2	150	200	6000	3000	60.0	0.60
B72220S2151K101	S20K150E2	150	200	10000	3000	120.0	1.00
$V_{RMS} = 175\text{ V}$							
B72205S2171K101	S05K175E2	175	225	800	150	8.0	0.10
B72207S2171K101	S07K175E2	175	225	1750	500	17.0	0.25
B72210S2171K101	S10K175E2	175	225	3500	1500	35.0	0.40
B72214S2171K101	S14K175E2	175	225	6000	3000	70.0	0.60
B72220S2171K101	S20K175E2	175	225	10000	3000	135.0	1.00
$V_{RMS} = 210\text{ V}$							
B72205S2211K101	S05K210E2	210	270	800	150	9.5	0.10
B72207S2211K101	S07K210E2	210	270	1750	500	20.0	0.25
B72210S2211K101	S10K210E2	210	270	3500	1500	42.0	0.40
B72214S2211K101	S14K210E2	210	270	6000	3000	80.0	0.60
B72220S2211K101	S20K210E2	210	270	10000	3000	160.0	1.00
$V_{RMS} = 230\text{ V}$							
B72205S2231K101	S05K230E2	230	300	800	150	11.0	0.10
B72207S2231K101	S07K230E2	230	300	1750	500	23.0	0.25
B72210S2231K101	S10K230E2	230	300	3500	1500	45.0	0.40
B72214S2231K101	S14K230E2	230	300	6000	3000	90.0	0.60
B72220S2231K101	S20K230E2	230	300	10000	3000	180.0	1.00

¹⁾ **Note:** Nominal discharge current I_n according to UL 1449, 4th edition.

Characteristics (T_A = 25 °C)

Ordering code	V _V (1 mA) V	ΔV _V (1 mA) %	V _{C,max} (i _C) V	i _C A	C _{typ} (1 kHz) pF
V_{RMS} = 130 V					
B72205S2131K101	205	±10	340	5.0	135
B72207S2131K101	205	±10	340	10.0	245
B72210S2131K101	205	±10	340	25.0	500
B72214S2131K101	205	±10	340	50.0	880
B72220S2131K101	205	±10	340	100.0	1850
V_{RMS} = 140 V					
B72205S2141K101	220	±10	360	5.0	125
B72207S2141K101	220	±10	360	10.0	230
B72210S2141K101	220	±10	360	25.0	470
B72214S2141K101	220	±10	360	50.0	820
B72220S2141K101	220	±10	360	100.0	1700
V_{RMS} = 150 V					
B72205S2151K101	240	±10	395	5.0	115
B72207S2151K101	240	±10	395	10.0	210
B72210S2151K101	240	±10	395	25.0	430
B72214S2151K101	240	±10	395	50.0	750
B72220S2151K101	240	±10	395	100.0	1550
V_{RMS} = 175 V					
B72205S2171K101	270	±10	455	5.0	100
B72207S2171K101	270	±10	455	10.0	190
B72210S2171K101	270	±10	455	25.0	380
B72214S2171K101	270	±10	455	50.0	670
B72220S2171K101	270	±10	455	100.0	1350
V_{RMS} = 210 V					
B72205S2211K101	330	±10	545	5.0	75
B72207S2211K101	330	±10	545	10.0	140
B72210S2211K101	330	±10	545	25.0	290
B72214S2211K101	330	±10	545	50.0	580
B72220S2211K101	330	±10	545	100.0	1100
V_{RMS} = 230 V					
B72205S2231K101	360	±10	595	5.0	70
B72207S2231K101	360	±10	595	10.0	130
B72210S2231K101	360	±10	595	25.0	265
B72214S2231K101	360	±10	595	50.0	530
B72220S2231K101	360	±10	595	100.0	1000

Leaded varistors
B722*
AdvanceD series
Electrical specifications and ordering codes
Maximum ratings ($T_A = 105\text{ }^\circ\text{C}$)

Ordering code	Type (untaped) SIOV-	V_{RMS} V	V_{DC} V	i_{max} (8/20 μ s) 1 time A	I_n ¹⁾ (8/20 μ s) 15 times A	W_{max} (2 ms) J	P_{max} W
$V_{RMS} = 250\text{ V}$							
B72205S2251K101	S05K250E2	250	320	800	150	12.0	0.10
B72207S2251K101	S07K250E2	250	320	1750	500	25.0	0.25
B72210S2251K101	S10K250E2	250	320	3500	1500	50.0	0.40
B72214S2251K101	S14K250E2	250	320	6000	3000	100.0	0.60
B72220S2251K101	S20K250E2	250	320	10000	3000	195.0	1.00
$V_{RMS} = 275\text{ V}$							
B72205S2271K101	S05K275E2	275	350	800	150	13.5	0.10
B72207S2271K101	S07K275E2	275	350	1750	500	27.5	0.25
B72210S2271K101	S10K275E2	275	350	3500	1500	55.0	0.40
B72214S2271K101	S14K275E2	275	350	6000	3000	110.0	0.60
B72220S2271K101	S20K275E2	275	350	10000	3000	215.0	1.00
$V_{RMS} = 300\text{ V}$							
B72205S2301K101	S05K300E2	300	385	800	150	15.0	0.10
B72207S2301K101	S07K300E2	300	385	1750	500	30.0	0.25
B72210S2301K101	S10K300E2	300	385	3500	1500	60.0	0.40
B72214S2301K101	S14K300E2	300	385	6000	3000	125.0	0.60
B72220S2301K101	S20K300E2	300	385	10000	3000	250.0	1.00
$V_{RMS} = 320\text{ V}$							
B72207S2321K101	S07K320E2	320	420	1750	500	32.0	0.25
B72210S2321K101	S10K320E2	320	420	3500	1500	67.0	0.40
B72214S2321K101	S14K320E2	320	420	6000	3000	136.0	0.60
B72220S2321K101	S20K320E2	320	420	10000	3000	273.0	1.00
$V_{RMS} = 350\text{ V}$							
B72210S2351K101	S10K350E2	350	460	3500	1500	67.0	0.40
B72214S2351K101	S14K350E2	350	460	5000	3000	136.0	0.60
B72220S2351K101	S20K350E2	350	460	10000	3000	273.0	1.00
$V_{RMS} = 385\text{ V}$							
B72210S2381K101	S10K385E2	385	505	3500	1500	67.0	0.40
B72214S2381K101	S14K385E2	385	505	5000	3000	136.0	0.60
B72220S2381K101	S20K385E2	385	505	10000	3000	273.0	1.00

¹⁾ **Note:** Nominal discharge current I_n according to UL 1449, 4th edition.

Characteristics (T_A = 25 °C)

Ordering code	V _V (1 mA) V	ΔV _V (1 mA) %	V _{C,max} (i _C) V	i _C A	C _{typ} (1 kHz) pF
V_{RMS} = 250 V					
B72205S2251K101	390	±10	650	5.0	65
B72207S2251K101	390	±10	650	10.0	120
B72210S2251K101	390	±10	650	25.0	245
B72214S2251K101	390	±10	650	50.0	490
B72220S2251K101	390	±10	650	100.0	940
V_{RMS} = 275 V					
B72205S2271K101	430	±10	710	5.0	60
B72207S2271K101	430	±10	710	10.0	110
B72210S2271K101	430	±10	710	25.0	220
B72214S2271K101	430	±10	710	50.0	440
B72220S2271K101	430	±10	710	100.0	850
V_{RMS} = 300 V					
B72205S2301K101	470	±10	775	5.0	55
B72207S2301K101	470	±10	775	10.0	100
B72210S2301K101	470	±10	775	25.0	200
B72214S2301K101	470	±10	775	50.0	400
B72220S2301K101	470	±10	775	100.0	780
V_{RMS} = 320 V					
B72207S2321K101	510	±10	840	10.0	90
B72210S2321K101	510	±10	840	25.0	185
B72214S2321K101	510	±10	840	50.0	370
B72220S2321K101	510	±10	840	100.0	720
V_{RMS} = 350 V					
B72210S2351K101	560	±10	910	25.0	160
B72214S2351K101	560	±10	910	50.0	350
B72220S2351K101	560	±10	910	100.0	660
V_{RMS} = 385 V					
B72210S2381K101	620	±10	1025	25.0	175
B72214S2381K101	620	±10	1025	50.0	315
B72220S2381K101	620	±10	1025	100.0	600

Leaded varistors
B722*
AdvanceD series
Electrical specifications and ordering codes
Maximum ratings ($T_A = 105\text{ }^\circ\text{C}$)

Ordering code	Type (untaped) SIOV-	V_{RMS} V	V_{DC} V	i_{max} (8/20 μ s) 1 time A	I_n ¹⁾ (8/20 μ s) 15 times A	W_{max} (2 ms) J	P_{max} W
$V_{RMS} = 420\text{ V}$							
B72210S2421K101	S10K420E2	420	560	3500	1500	67.0	0.40
B72214S2421K101	S14K420E2	420	560	5000	3000	136.0	0.60
B72220S2421K101	S20K420E2	420	560	10000	3000	273.0	1.00
$V_{RMS} = 460\text{ V}$							
B72210S2461K101	S10K460E2	460	615	3500	1500	70.0	0.40
B72214S2461K101	S14K460E2	460	615	5000	3000	150.0	0.60
B72220S2461K101	S20K460E2	460	615	10000	3000	300.0	1.00
$V_{RMS} = 510\text{ V}$							
B72210S2511K101	S10K510E2	510	670	3500	1500	80.0	0.40
B72214S2511K101	S14K510E2	510	670	5000	3000	165.0	0.60
B72220S2511K101	S20K510E2	510	670	10000	3000	325.0	1.00
$V_{RMS} = 550\text{ V}$							
B72210S2551K101	S10K550E2	550	745	3500	1500	90.0	0.40
B72214S2551K101	S14K550E2	550	745	5000	3000	180.0	0.60
B72220S2551K101	S20K550E2	550	745	10000	3000	360.0	1.00
$V_{RMS} = 625\text{ V}$							
B72210S2621K101	S10K625E2	625	825	3500	1500	100.0	0.40
B72214S2621K101	S14K625E2	625	825	5000	3000	200.0	0.60
B72220S2621K101	S20K625E2	625	825	10000	3000	400.0	1.00
$V_{RMS} = 680\text{ V}$							
B72210S2681K101	S10K680E2	680	895	3500	1500	110.0	0.40
B72214S2681K101	S14K680E2	680	895	5000	3000	220.0	0.60
B72220S2681K101	S20K680E2	680	895	10000	3000	440.0	1.00

¹⁾ **Note:** Nominal discharge current I_n , according to UL 1449, 4th edition.

Characteristics (T_A = 25 °C)

Ordering code	V _V (1 mA) V	ΔV _V (1 mA) %	V _{C,max} (i _C) V	i _C A	C _{typ} (1 kHz) pF
V_{RMS} = 420 V					
B72210S2421K101	680	±10	1120	25.0	165
B72214S2421K101	680	±10	1120	50.0	290
B72220S2421K101	680	±10	1120	100.0	550
V_{RMS} = 460 V					
B72210S2461K101	750	±10	1240	25.0	150
B72214S2461K101	750	±10	1240	50.0	260
B72220S2461K101	750	±10	1240	100.0	500
V_{RMS} = 510 V					
B72210S2511K101	820	±10	1355	25.0	140
B72214S2511K101	820	±10	1355	50.0	240
B72220S2511K101	820	±10	1355	100.0	460
V_{RMS} = 550 V					
B72210S2551K101	910	±10	1500	25.0	120
B72214S2551K101	910	±10	1500	50.0	215
B72220S2551K101	910	±10	1500	100.0	410
V_{RMS} = 625 V					
B72210S2621K101	1000	±10	1650	25.0	110
B72214S2621K101	1000	±10	1650	50.0	200
B72220S2621K101	1000	±10	1650	100.0	380
V_{RMS} = 680 V					
B72210S2681K101	1100	±10	1815	25.0	100
B72214S2681K101	1100	±10	1815	50.0	180
B72220S2681K101	1100	±10	1815	100.0	340

Dimensional drawings

1) Seating plane to IEC 60717

VAR0408-C-E

Weight

Nominal diameter mm	V_{RMS} V	Weight g
5	130 ... 300	0.4 ... 0.5
7	130 ... 320	0.6 ... 0.8
10	130 ... 680	1.2 ... 2.8
14	130 ... 680	1.8 ... 4.8
20	130 ... 680	3.3 ... 9.6

The weight of varistors in between these voltage classes can be interpolated.

Dimensions

Ordering code	[e] ±1 mm	a (typical) mm	w _{max} mm	th _{max} mm	h _{max} mm	l _{min} mm	d ±0.05 mm
$V_{RMS} = 130 V$							
B72205S2131K101	5.0	1.6	7.0	3.9	8.5	25.0	0.6
B72207S2131K101	5.0	1.6	9.0	3.9	11.0	25.0	0.6
B72210S2131K101	7.5	1.8	12.0	4.5	14.5	25.0	0.8
B72214S2131K101	7.5	1.9	15.5	4.6	18.5	25.0	0.8
B72220S2131K101	10.0	2.0	21.5	5.0	25.5	25.0	1.0
$V_{RMS} = 140 V$							
B72205S2141K101	5.0	1.7	7.0	4.0	8.5	25.0	0.6
B72207S2141K101	5.0	1.7	9.0	4.0	11.0	25.0	0.6
B72210S2141K101	7.5	1.9	12.0	4.6	14.5	25.0	0.8
B72214S2141K101	7.5	2.0	15.5	4.7	18.5	25.0	0.8
B72220S2141K101	10.0	2.1	21.5	5.1	25.5	25.0	1.0
$V_{RMS} = 150 V$							
B72205S2151K101	5.0	1.8	7.0	4.1	8.5	25.0	0.6
B72207S2151K101	5.0	1.8	9.0	4.1	11.0	25.0	0.6
B72210S2151K101	7.5	2.0	12.0	4.7	14.5	25.0	0.8
B72214S2151K101	7.5	2.1	15.5	4.8	18.5	25.0	0.8
B72220S2151K101	10.0	2.2	21.5	5.2	25.5	25.0	1.0
$V_{RMS} = 175 V$							
B72205S2171K101	5.0	2.0	7.0	4.3	8.5	25.0	0.6
B72207S2171K101	5.0	2.0	9.0	4.3	11.0	25.0	0.6
B72210S2171K101	7.5	2.2	12.0	4.9	14.5	25.0	0.8
B72214S2171K101	7.5	2.2	15.5	4.9	18.5	25.0	0.8
B72220S2171K101	10.0	2.3	21.5	5.3	25.5	25.0	1.0

Leaded varistors
B722*
AdvanceD series

Ordering code	[e] ±1 mm	a (typical) mm	w _{max} mm	th _{max} mm	h _{max} mm	l _{min} mm	d ±0.05 mm
V_{RMS} = 210 V							
B72205S2211K101	5.0	1.7	7.0	4.2	8.5	25.0	0.6
B72207S2211K101	5.0	1.7	9.0	4.2	11.0	25.0	0.6
B72210S2211K101	7.5	1.9	12.0	5.0	14.5	25.0	0.8
B72214S2211K101	7.5	1.9	15.5	5.0	18.5	25.0	0.8
B72220S2211K101	10.0	2.2	21.5	5.4	25.5	25.0	1.0
V_{RMS} = 230 V							
B72205S2231K101	5.0	1.5	7.0	4.4	8.5	25.0	0.6
B72207S2231K101	5.0	1.5	9.0	4.4	11.0	25.0	0.6
B72210S2231K101	7.5	1.7	12.0	5.0	14.5	25.0	0.8
B72214S2231K101	7.5	1.7	15.5	5.1	18.5	25.0	0.8
B72220S2231K101	10.0	1.8	21.5	5.5	25.5	25.0	1.0
V_{RMS} = 250 V							
B72205S2251K101	5.0	1.5	7.0	4.5	8.5	25.0	0.6
B72207S2251K101	5.0	1.5	9.0	4.5	11.0	25.0	0.6
B72210S2251K101	7.5	1.7	12.0	5.2	14.5	25.0	0.8
B72214S2251K101	7.5	1.7	15.5	5.2	18.5	25.0	0.8
B72220S2251K101	10.0	1.9	21.5	5.7	25.5	25.0	1.0
V_{RMS} = 275 V							
B72205S2271K101	5.0	1.6	7.0	4.6	8.5	25.0	0.6
B72207S2271K101	5.0	1.6	9.0	4.6	11.0	25.0	0.6
B72210S2271K101	7.5	1.8	12.0	5.4	14.5	25.0	0.8
B72214S2271K101	7.5	1.8	15.5	5.4	18.5	25.0	0.8
B72220S2271K101	10.0	2.0	21.5	5.8	25.5	25.0	1.0
V_{RMS} = 300 V							
B72205S2301K101	5.0	1.7	7.0	4.7	8.5	25.0	0.6
B72207S2301K101	5.0	1.7	9.0	4.7	11.0	25.0	0.6
B72210S2301K101	7.5	1.9	12.0	5.6	14.5	25.0	0.8
B72214S2301K101	7.5	1.9	15.5	5.6	18.5	25.0	0.8
B72220S2301K101	10.0	2.1	21.5	6.1	25.5	25.0	1.0
V_{RMS} = 320 V							
B72207S2321K101	5.0	1.9	9.0	4.6	11.0	25.0	0.6
B72210S2321K101	7.5	2.1	12.0	5.8	15.0	25.0	0.8
B72214S2321K101	7.5	2.1	15.5	5.8	19.0	25.0	0.8
B72220S2321K101	10.0	2.3	21.5	6.2	25.5	25.0	1.0

Leaded varistors
B722*
AdvanceD series

Ordering code	[e] ±1 mm	a (typical) mm	w _{max} mm	th _{max} mm	h _{max} mm	l _{min} mm	d ±0.05 mm
V_{RMS} = 350 V							
B72210S2351K101	7.5	2.2	12.0	6.5	15.0	25.0	0.8
B72214S2351K101	7.5	2.2	15.5	6.5	19.0	25.0	0.8
B72220S2351K101	10.0	2.4	21.5	7.0	25.5	25.0	1.0
V_{RMS} = 385 V							
B72210S2381K101	7.5	2.4	12.0	7.1	15.0	25.0	0.8
B72214S2381K101	7.5	2.4	15.5	7.1	19.0	25.0	0.8
B72220S2381K101	10.0	2.5	21.5	7.6	26.0	25.0	1.0
V_{RMS} = 420 V							
B72210S2421K101	7.5	2.6	12.0	7.4	15.0	25.0	0.8
B72214S2421K101	7.5	2.6	15.5	7.5	19.0	25.0	0.8
B72220S2421K101	10.0	2.7	21.5	7.9	26.0	25.0	1.0
V_{RMS} = 460 V							
B72210S2461K101	7.5	2.8	12.0	7.7	15.0	25.0	0.8
B72214S2461K101	7.5	2.8	15.5	7.8	19.0	25.0	0.8
B72220S2461K101	10.0	3.0	21.5	8.2	26.0	25.0	1.0
V_{RMS} = 510 V							
B72210S2511K101	7.5	3.1	12.0	8.0	15.0	25.0	0.8
B72214S2511K101	7.5	3.1	15.5	8.1	19.0	25.0	0.8
B72220S2511K101	10.0	3.2	21.5	8.6	26.0	25.0	1.0
V_{RMS} = 550 V							
B72210S2551K101	7.5	3.4	12.0	8.4	15.0	25.0	0.8
B72214S2551K101	7.5	3.4	15.5	8.5	19.0	25.0	0.8
B72220S2551K101	10.0	3.6	21.5	9.0	26.0	25.0	1.0
V_{RMS} = 625 V							
B72210S2621K101	7.5	3.7	12.0	8.8	15.0	25.0	0.8
B72214S2621K101	7.5	3.7	15.5	8.9	19.0	25.0	0.8
B72220S2621K101	10.0	3.9	21.5	9.4	26.0	25.0	1.0
V_{RMS} = 680 V							
B72210S2681K101	7.5	4.1	12.0	9.2	15.0	25.0	0.8
B72214S2681K101	7.5	4.1	15.5	9.3	19.0	25.0	0.8
B72220S2681K101	10.0	4.2	21.5	9.8	26.0	25.0	1.0

Reliability data

Test	Test methods/conditions	Requirement
Varistor voltage	The voltage between two terminals with the specified measuring current applied is called V_V (1 mA _{DC} @ 0.2 ... 2 s).	To meet the specified value
Clamping voltage	The maximum voltage between two terminals with the specified standard impulse current (8/20 μ s) applied.	To meet the specified value
Endurance at upper category temperature	1000 h at UCT After having continuously applied the maximum allowable AC voltage at UCT ± 2 °C for 1000 h, the specimen shall be stored at room temperature and normal humidity for 1 to 2 h. Thereafter, the change of V_V shall be measured.	$ \Delta V/V$ (1 mA) $\leq 10\%$
Surge current derating, 8/20 μ s	10 surge currents (8/20 μ s), unipolar, interval 30 s, amplitude corresponding to derating curve for 10 impulses at 20 μ s	$ \Delta V/V$ (1 mA) $\leq 10\%$ (measured in direction of surge current) No visible damage
Surge current derating, 2 ms	10 surge currents (2 ms), unipolar, interval 120 s, amplitude corresponding to derating curve for 10 impulses at 2 ms	$ \Delta V/V$ (1 mA) $\leq 10\%$ (measured in direction of surge current) No visible damage
Electric strength	IEC 61051-1, test 4.9.2 Metal balls method, 2500 V _{RMS} , 60 s The varistor is placed in a container holding 1.6 \pm 0.2 mm diameter metal balls such that only the terminations of the varistor are protruding. The specified voltage shall be applied between both terminals of the specimen connected together and the electrode inserted between the metal balls.	No breakdown

Leaded varistors
B722*
AdvanceD series

Test	Test methods/conditions	Requirement
Climatic sequence	<p>The specimen shall be subjected to:</p> <p>a) dry heat at UCT, 16 h, IEC 60068-2-2, test Ba</p> <p>b) damp heat, 1st cycle: 55 °C, 93% r. H., 24 h, IEC 60068-2-30, test Db</p> <p>c) cold, LCT, 2 h, IEC 60068-2-1, test Aa</p> <p>d) damp heat, additional 5 cycles: 55 °C/25 °C, 93% r. H., 24 h/cycle, IEC 60068-2-30, test Db.</p> <p>Then the specimen shall be stored at room temperature and normal humidity for 1 to 2 h.</p> <p>Thereafter, the change of V_V shall be measured. Thereafter, insulation resistance R_{ins} shall be measured at $V = 500 V$.</p>	$ \Delta V/V (1 mA) \leq 10\%$ $R_{ins} \geq 100 M\Omega$
Rapid change of temperature	IEC 60068-2-14, test Na, LCT/UCT, dwell time 30 min, 5 cycles	$ \Delta V/V (1 mA) \leq 5\%$ No visible damage
Damp heat, steady state	IEC 60068-2-78, test Ca The specimen shall be subjected to 40 ± 2 °C, 90 to 95% r. H. for 56 days without load / with 10% of the maximum continuous DC operating voltage V_{DC} . Then stored at room temperature and normal humidity for 1 to 2 h. Thereafter, the change of V_V shall be measured. Thereafter, insulation resistance R_{ins} shall be measured at $V = 500 V$ (insulated varistors only).	$ \Delta V/V (1 mA) \leq 10\%$ $R_{ins} \geq 100 M\Omega$



Test	Test methods/conditions	Requirement
Solderability	<p>IEC 60068-2-20, test Ta, method 1 with modified conditions for lead-free solder alloys: 245 °C, 3 s:</p> <p>After dipping the terminals to a depth of approximately 3 mm from the body in a soldering bath of 245 °C for 3 s, the terminals shall be visually examined.</p>	<p>The inspection shall be carried out under adequate light with normal eyesight or with the assistance of a magnifier capable of giving a magnification of 4 to 10 times. The dipped surface shall be covered with a smooth and bright solder coating with no more than small amounts of scattered imperfections such as pinholes or un-wetted or de-wetted areas. These imperfections shall not be concentrated in one area.</p>
Resistance to soldering heat	<p>IEC 60068-2-20, test Tb, method 1A, 260 °C, 10 s:</p> <p>Each lead shall be dipped into a solder bath having a temperature of 260 ±5 °C to a point 2.0 to 2.5 mm from the body of the specimen, be held there for 10 ±1 s and then be stored at room temperature and normal humidity for 1 to 2 h.</p> <p>The change of V_V shall be measured and the specimen shall be visually examined.</p>	<p>$\Delta V/V (1 \text{ mA}) \leq 5\%$</p> <p>No visible damage</p>
Tensile strength	<p>IEC 60068-2-21, test Ua1</p> <p>After gradually applying the force specified below and keeping the unit fixed for 10 s, the terminal shall be visually examined for any damage.</p> <p>Force for wire diameter:</p> <p>0.6 mm = 10 N 0.8 mm = 10 N 1.0 mm = 20 N</p>	<p>$\Delta V/V (1 \text{ mA}) \leq 5\%$</p> <p>No break of solder joint, no wire break</p>



Leaded varistors

B722*

AdvanceD series

Test	Test methods/conditions	Requirement
Vibration	IEC 60068-2-6, test Fc, method B4 Frequency range: 10 ... 55 Hz Amplitude: 0.75 mm or 98 m/s ² Duration: 6 h (3 · 2 h) Pulse: sine wave After repeatedly applying a single harmonic vibration according to the table above. The change of V _v shall be measured and the specimen shall be visually examined.	ΔV/V (1 mA) ≤5% No visible damage
Bump	IEC 60068-2-29, test Eb Pulse duration: 6 ms Max. acceleration: 400 m/s ² Number of bumps: 4000 Pulse: half sine	ΔV/V (1 mA) ≤5% No visible damage
Fire hazard	IEC 60695-11-5 (needle flame test) Severity: vertical 10 s	5 s max.

Note:

UCT = Upper category temperature

LCT = Lower category temperature

R_{ins} = Insulation resistance



v/i characteristics

$v = f(i)$ - for explanation of the characteristics refer to "General technical information", 1.6.3
 A = Leakage current, B = Protection level } for worst-case varistor tolerances



SIOV-S05 ... E2



SIOV-S07 ... E2



v/i characteristics

$v = f(i)$ - for explanation of the characteristics refer to "General technical information", 1.6.3

A = Leakage current, B = Protection level } for worst-case varistor tolerances



SIOV-S10 ... E2



v/i characteristics

v = f (i) - for explanation of the characteristics refer to "General technical information", 1.6.3

A = Leakage current, B = Protection level } for worst-case varistor tolerances



SIOV-S14 ... E2



v/i characteristics

$v = f(i)$ - for explanation of the characteristics refer to "General technical information", 1.6.3

A = Leakage current, B = Protection level } for worst-case varistor tolerances



SIOV-S20 ... E2



Derating curves

Maximum surge current $i_{max} = f(t_r, \text{pulse train})$

For explanation of the derating curves refer to "General technical information", section 1.8.1



SIOV-S05K130 ... K300E2



SIOV-S07K130 ... K320E2



Derating curves

Maximum surge current $i_{max} = f(t_r, \text{pulse train})$

For explanation of the derating curves refer to "General technical information", section 1.8.1



SIOV-S10K130 ... K320E2



SIOV-S10K350 ... K680E2



Derating curves

Maximum surge current $i_{max} = f(t_r, \text{pulse train})$

For explanation of the derating curves refer to "General technical information", section 1.8.1



SIOV-S14K130 ... K320E2



SIOV-S14K350 ... K680E2



Derating curves

Maximum surge current $i_{max} = f(t_r, \text{pulse train})$

For explanation of the derating curves refer to "General technical information", section 1.8.1



SIOV-S20K130 ... K320E2



SIOV-S20K350 ... K680E2

Taping, packaging and lead configuration
1 EPCOS ordering code system
For leaded varistors



2 Taping and packaging of leaded varistors

Tape packaging for lead spacing \boxed{e} = 5 fully conforms to IEC 60286-2, while for lead spacings \boxed{e} = 7.5 and 10 the taping mode is based on this standard.

2.1 Taping in accordance with IEC 60286-2 for lead spacing 5.0 mm



2.2 Taping based on IEC 60286-2 for lead spacing 7.5 and 10 mm



2.3 Tape dimensions (in mm)

Symbol	$e = 5.0$	Tolerance	$e = 7.5$	Tolerance	$e = 10.0$	Tolerance	Remarks	
w		max.		max.		max.	see tables in each series under "Dimensions"	
th		max.		max.		max.		
d	0.6	± 0.05	0.8	± 0.05	1.0	± 0.05		
P ₀	12.7	± 0.3	12.7 ¹⁾	± 0.3	12.7	± 0.3	± 1 mm/20 sprocket holes	
P ₁	3.85	± 0.7	8.95	± 0.8	7.7	± 0.8		
F	5.0	$+0.6/-0.1$	7.5	± 0.8	10.0	± 0.8	measured at top of component body	
Δh	0	± 2.0	depends on s		depends on s			
Δp	0	± 1.3	0	± 2.0	0	± 2.0		
W	18.0	± 0.5	18.0	± 0.5	18.0	± 0.5	Peel-off force ≥ 5 N	
W ₀	5.5	min.	11.0	min.	11.0	min.		
W ₁	9.0	± 0.5	9.0	$+0.75/-0.5$	9.0	$+0.75/-0.5$		
W ₂	3.0	max.	3.0	max.	3.0	max.		
H	18.0	$+2.0/-0$	18.0	$+2.0/-0$	18.0	$+2.0/-0$	²⁾	
H ₀	16.0 (18.0)	± 0.5	16.0 (18.0)	± 0.5	16.0	± 0.5		³⁾
H ₁	32.2	max.	45.0	max.	45.0	max.		
D ₀	4.0	± 0.2	4.0	± 0.2	4.0	± 0.2	without lead	
t	0.9	max.	0.9	max.	0.9	max.		
L	11.0	max.	11.0	max.	11.0	max.		
L ₁	0.5	max.						

1) Taping with P₀ = 15.0 mm upon request

2) Applies only to uncrimped types

3) Applies only to crimped types (H₀ = 18 upon request)



2.4 Taping mode

Example: B72210S0271K1 5 1
|
Digit 14

Digit 14	Taping mode	Reel type	Seating plane height H_0 for crimped types mm	Seating plane height H for uncrimped types mm	Pitch distance P_0 mm
0	—	Bulk	—	—	—
1	G	I	16	18	12.7
2	G2	I	18	—	12.7
3	G3	II	16	18	12.7
4	G4	II	18	—	12.7
5	G5	III	16	18	12.7
6	GA	Ammo pack	16	18	12.7
7	G2A	Ammo pack	18	—	12.7

Internal coding for special taping

G6	III	18	—	12.7
G10	II	16	18	15.0
G11	II	18	—	15.0
G10A	Ammo pack	16	18	15.0
G11A	Ammo pack	18	—	15.0

2.5 Reel dimension



Dimensions (in mm)

Reel type	d	f	n	w
I	360 max.	31 ±1	approx. 45	54 max.
II	360 max.	31 ±1	approx. 55	64 max.
III	500 max.	23 ±1	approx. 59	72 max.

If reel type III is not compatible with insertion equipment because of its large diameter, nominal disk diameter 10 mm and 14 mm can be supplied on reel II upon request (taping mode G3).



2.6 Ammo pack dimensions



VAR0402-G

3 Lead configuration

Straight leads are standard for disk varistors. Other lead configurations as crimp style or customer-specific lead wire length according to 3.1, 3.2, 3.3 and 3.4 are optional. Crimped leads (non-standard) are differently crimped for technical reasons; the individual crimp styles are denoted by consecutive numbers (S, S2 through S5) as shown in the dimensional drawings below.

The crimp styles of the individual types can be seen from the type designation in the ordering tables.

3.1 Crimp style mode

Example: B72210S0271K **5** 01

Digit 13

Digit 13 of ordering code	Crimp style	Figure
1	Standard, straight leads	1
2	S2	2
3	S3	3
5	S5	4
Available upon request		
Internal coding	—	5



3.2 Standard leads and non-standard crimp styles

The basic dimensions in figure 1 to 5 are valid for types with either round or square (EnergetiQ series) component head.

Standard, straight leads



Figure 1

Non-standard, crimp style S2



Figure 2

Non-standard, crimp style S3

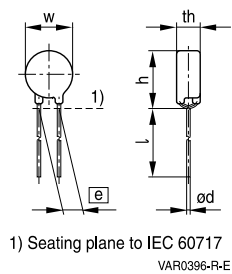

Figure 3

Non-standard, crimp style S5



Figure 4



3.3 Trimmed leads (non-standard)

Varistors with cut leads available upon request.

Lead length tolerances:

Straight leads ± 0.8 mm

Crimped leads ± 0.5 mm

Minimum lead length 3.0 mm



1) Seating plane to IEC 60717

*) For round component head

***) For EnergetiQ series, square component head

VAR0642-U-E

Figure 5



Cautions and warnings

General

1. EPCOS metal oxide varistors are designed for specific applications and should not be used for purposes not identified in our specifications, application notes and data books unless otherwise agreed with EPCOS during the design-in-phase.
2. Ensure suitability of SIOVs through reliability testing during the design-in phase. SIOVs should be evaluated taking into consideration worst-case conditions.
3. For applications of SIOVs in line-to-ground circuits based on various international and local standards there are restrictions existing or additional safety measures required.

Storage

1. Store SIOVs only in original packaging. Do not open the package prior to processing.
2. Recommended storage conditions in original packaging:
 Storage temperature: $-25\text{ }^{\circ}\text{C} \dots +45\text{ }^{\circ}\text{C}$,
 Relative humidity: $<75\%$ annual average,
 $<95\%$ on maximum 30 days a year.
 Dew precipitation: is to be avoided.
3. Avoid contamination of an SIOV's during storage, handling and processing.
4. Avoid storage of SIOVs in harmful environments that can affect the function during long-term operation (examples given under operation precautions).
5. The SIOV type series should be soldered after shipment from EPCOS within the time specified:

SIOV-S, -Q, -LS, -B, -SNF	24 months
ETFV/ T series, -CU	12 months.

Handling

1. SIOVs must not be dropped.
2. Components must not be touched with bare hands. Gloves are recommended.
3. Avoid contamination of the surface of SIOV electrodes during handling, be careful of the sharp edge of SIOV electrodes.

Soldering (where applicable)

1. Use rosin-type flux or non-activated flux.
2. Insufficient preheating may cause ceramic cracks.
3. Rapid cooling by dipping in solvent is not recommended.
4. Complete removal of flux is recommended.
5. Temperatures of all preheat stages and the solder bath must be strictly controlled especially for T series (T14 and T20).



Mounting

1. Potting, sealing or adhesive compounds can produce chemical reactions in the SIOV ceramic that will degrade the component's electrical characteristics.
2. Overloading SIOVs may result in ruptured packages and expulsion of hot materials. For this reason SIOVs should be physically shielded from adjacent components.

Operation

1. Use SIOVs only within the specified temperature operating range.
2. Use SIOVs only within the specified voltage and current ranges.
3. Environmental conditions must not harm SIOVs. Use SIOVs only in normal atmospheric conditions. Avoid use in deoxidizing gases (chlorine gas, hydrogen sulfide gas, ammonia gas, sulfuric acid gas etc), corrosive agents, humid or salty conditions. Contact with any liquids and solvents should be prevented.

Display of ordering codes for EPCOS products

The ordering code for one and the same EPCOS product can be represented differently in data sheets, data books, other publications, on the EPCOS website, or in order-related documents such as shipping notes, order confirmations and product labels. **The varying representations of the ordering codes are due to different processes employed and do not affect the specifications of the respective products.** Detailed information can be found on the Internet under www.epcos.com/orderingcodes

Symbols and terms

Symbol	Term
C	Capacitance
C_{typ}	Typical capacitance
i	Current
i_c	Current at which $V_{c, max}$ is measured
I_{leak}	Leakage current
i_{max}	Maximum surge current (also termed peak current)
I_{max}	Maximum discharge current
I_n	Nominal discharge current to UL 1449
LCT	Lower category temperature
L_{typ}	Typical inductance
P_{max}	Maximum average power dissipation
R_{ins}	Insulation resistance
R_{min}	Minimum resistance
T_A	Ambient temperature
t_r	Duration of equivalent rectangular wave
UCT	Upper category temperature
v	Voltage
V_{clamp}	Clamping voltage
$V_{c, max}$	Maximum clamping voltage at specified current i_c
V_{DC}	DC operating voltage
V_{jump}	Maximum jump start voltage
V_{max}	Maximum voltage
V_{op}	Operating voltage
V_{RMS}	AC operating voltage, root-mean-square value
$V_{RMS, op, max}$	Root-mean-square value of max. DC operating voltage incl. ripple current
V_{surge}	Super imposed surge voltage
V_V	Varistor voltage
ΔV_V	Tolerance of varistor voltage
W_{LD}	Maximum load dump
W_{max}	Maximum energy absorption
e	Lead spacing

All dimensions are given in mm.

The commas used in numerical values denote decimal points.

Important notes

The following applies to all products named in this publication:

1. Some parts of this publication contain **statements about the suitability of our products for certain areas of application**. These statements are based on our knowledge of typical requirements that are often placed on our products in the areas of application concerned. We nevertheless expressly point out **that such statements cannot be regarded as binding statements about the suitability of our products for a particular customer application**. As a rule we are either unfamiliar with individual customer applications or less familiar with them than the customers themselves. For these reasons, it is always ultimately incumbent on the customer to check and decide whether a product with the properties described in the product specification is suitable for use in a particular customer application.
2. We also point out that **in individual cases, a malfunction of electronic components or failure before the end of their usual service life cannot be completely ruled out in the current state of the art, even if they are operated as specified**. In customer applications requiring a very high level of operational safety and especially in customer applications in which the malfunction or failure of an electronic component could endanger human life or health (e.g. in accident prevention or life-saving systems), it must therefore be ensured by means of suitable design of the customer application or other action taken by the customer (e.g. installation of protective circuitry or redundancy) that no injury or damage is sustained by third parties in the event of malfunction or failure of an electronic component.
3. **The warnings, cautions and product-specific notes must be observed.**
4. In order to satisfy certain technical requirements, **some of the products described in this publication may contain substances subject to restrictions in certain jurisdictions (e.g. because they are classed as hazardous)**. Useful information on this will be found in our Material Data Sheets on the Internet (www.tdk-electronics.tdk.com/material). Should you have any more detailed questions, please contact our sales offices.
5. We constantly strive to improve our products. Consequently, **the products described in this publication may change from time to time**. The same is true of the corresponding product specifications. Please check therefore to what extent product descriptions and specifications contained in this publication are still applicable before or when you place an order.

We also **reserve the right to discontinue production and delivery of products**. Consequently, we cannot guarantee that all products named in this publication will always be available. The aforementioned does not apply in the case of individual agreements deviating from the foregoing for customer-specific products.
6. Unless otherwise agreed in individual contracts, **all orders are subject to our General Terms and Conditions of Supply**.
7. **Our manufacturing sites serving the automotive business apply the IATF 16949 standard**. The IATF certifications confirm our compliance with requirements regarding the quality management system in the automotive industry. Referring to customer requirements and customer specific requirements ("CSR") TDK always has and will continue to have the policy of respecting individual agreements. Even if IATF 16949 may appear to support the acceptance of unilateral requirements, we hereby like to emphasize that **only requirements mutually agreed upon can and will be implemented in our Quality Management System**. For clarification purposes we like to point out that obligations from IATF 16949 shall only become legally binding if individually agreed upon.

Important notes

8. The trade names EPCOS, CeraCharge, CeraDiode, CeraLink, CeraPad, CeraPlas, CSMP, CTVS, DeltaCap, DigiSiMic, ExoCore, FilterCap, FormFit, LeaXield, MiniBlue, MiniCell, MKD, MKK, MotorCap, PCC, PhaseCap, PhaseCube, PhaseMod, PhiCap, PowerHap, PQSine, PQvar, SIFERRIT, SIFI, SIKOREL, SilverCap, SIMDAD, SiMic, SIMID, SineFormer, SIOV, ThermoFuse, WindCap are **trademarks registered or pending** in Europe and in other countries. Further information will be found on the Internet at www.tdk-electronics.tdk.com/trademarks.

Release 2018-10

Mouser Electronics

Authorized Distributor

Click to View Pricing, Inventory, Delivery & Lifecycle Information:

EPCOS / TDK:

[B72207S2381K101](#) [B72214S2421K551](#) [B72210S2301K131](#) [B72210S251K551](#) [B72207S2151K211](#)
[B72214S2381K501](#) [B72214S2271K551](#) [B72210S2271K111](#) [B72210S2950K101](#) [B72207S2321K311](#)
[B72207S2950K101](#) [B72214S2301K551](#) [B72210S2251K151](#) [B72210S2551K501](#) [B72210S2301K551](#)
[B72214S2461K501](#) [B72214S2131K131](#) [B72214S2271K301](#) [B72214S2301K301](#) [B72205S2271K111](#)
[B72210S2381K551](#) [B72205S2271K311](#) [B72210S2151K551](#) [B72214S2551K551](#) [B72214S2321K551](#)
[B72214S2551K151](#) [B72214S2950K101](#) [B72210S2251K551](#) [B72220S2381K501](#) [B72207S2271K311](#)
[B72214S2151K551](#) [B72210S2271K341](#) [B72220S2950K101](#) [B72214S2321K151](#) [B72210S2301K111](#)
[B72205S2950K101](#) [B72214S2151K151](#) [B72210S200K531](#) [B72210S271K111](#) [B72220S200K131](#) [B72220S250K151](#)
[B72205S250K111](#) [B72210S271K341](#) [B72214S271K131](#) [B72205S231K311](#) [B72205S271K341](#) [B72214S250K551](#)
[B72214S271K531](#) [B72220S271K551](#) [B72210S200K151](#) [B72214S231K151](#) [B72205S271K211](#) [B72205S231K111](#)
[B72220S231K551](#) [B72205S251K311](#) [B72214S250K151](#) [B72214S200K151](#) [B72214S200K551](#) [B72205S250K211](#)
[B72205S271K311](#) [B72220S251K551](#) [B72220S271K151](#) [B72214S251K151](#) [B72214S231K551](#) [B72205S271K111](#)
[B72214S271K151](#) [B72207S231K111](#) [B72207S271K321](#) [B72210S231K551](#) [B72207S251K311](#) [B72205S200K211](#)
[B72214S251K551](#) [B72214S271K501](#) [B72205S200K111](#) [B72214S271K551](#) [B72214S251K501](#) [B72205S251K111](#)
[B72210S250K551](#) [B72210S231K151](#) [B72210S250K151](#) [B72210S271K551](#) [B72207S211K101](#) [B72207S251K111](#)
[B72207S250K111](#) [B72207S250K211](#) [B72210S251K151](#) [B72210S200K551](#) [B72207S271K111](#) [B72207S271K311](#)
[B72207S251K211](#) [B72210S271K531](#) [B72210S271K151](#) [B72207S200K111](#) [B72207S271K211](#) [B72207S200K211](#)
[B72210S271K501](#) [B72207S231K211](#) [B72207S231K311](#) [B72214S2271K151](#) [B72214S2381K301](#)



Компания «ЭлектроПласт» предлагает заключение долгосрочных отношений при поставках импортных электронных компонентов на взаимовыгодных условиях!

Наши преимущества:

- Оперативные поставки широкого спектра электронных компонентов отечественного и импортного производства напрямую от производителей и с крупнейших мировых складов;
- Поставка более 17-ти миллионов наименований электронных компонентов;
- Поставка сложных, дефицитных, либо снятых с производства позиций;
- Оперативные сроки поставки под заказ (от 5 рабочих дней);
- Экспресс доставка в любую точку России;
- Техническая поддержка проекта, помощь в подборе аналогов, поставка прототипов;
- Система менеджмента качества сертифицирована по Международному стандарту ISO 9001;
- Лицензия ФСБ на осуществление работ с использованием сведений, составляющих государственную тайну;
- Поставка специализированных компонентов (Xilinx, Altera, Analog Devices, Intersil, Interpoint, Microsemi, Aeroflex, Peregrine, Syfer, Eurofarad, Texas Instrument, Miteq, Cobham, E2V, MA-COM, Hittite, Mini-Circuits, General Dynamics и др.);

Помимо этого, одним из направлений компании «ЭлектроПласт» является направление «Источники питания». Мы предлагаем Вам помощь Конструкторского отдела:

- Подбор оптимального решения, техническое обоснование при выборе компонента;
- Подбор аналогов;
- Консультации по применению компонента;
- Поставка образцов и прототипов;
- Техническая поддержка проекта;
- Защита от снятия компонента с производства.



Как с нами связаться

Телефон: 8 (812) 309 58 32 (многоканальный)

Факс: 8 (812) 320-02-42

Электронная почта: org@eplast1.ru

Адрес: 198099, г. Санкт-Петербург, ул. Калинина, дом 2, корпус 4, литера А.