

Surface-mounting Relay G6J-Y

Ultra-compact and Slim DPDT Relay

- Dimensions of 9H x 5.7W x 10.6L mm provide a mounting area reduction of approx. 56% when compared with the OMRON G6S.
- Dielectric strength of 1,500 VAC and an impulse withstand voltage of 2,500 V for 2 x 10 μs (conforms to Telcordia specifications (formerly Bellcore)).
- Conforms to FCC Part 68 requirements (1,500 V, 10 x 160 μs).
- Single-winding latching models to save energy.
- UL recognized / CSA certified.
- RoHS Compliant.

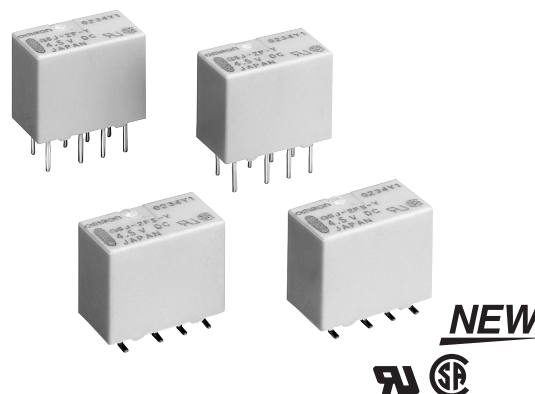

Ordering Information

Item		Model	
Terminal	Contact form	Non-latching	Single coil latching
PCB through-hole	DPDT	G6J-2P-Y	G6JU-2P-Y
SMT Gull-wing		G6J-2FL-Y	G6JU-2FL-Y
SMT Shortened leads		G6J-2FS-Y	G6JU-2FS-Y

Note 1: When ordering, add the rated coil voltage to the model number.
Example: G6J-2P-Y DC12
 └─── Rated coil voltage

Note 2: When ordering tape packing, add “-TR” to the model number.
Example: G6J-2P-Y-TR DC12
 └─── Rated coil voltage

“-TR” is not part of the relay model number. Therefore it is not marked on the relay case.

Model Number Legend:

G6J - - Y - DC
 1 2 3 4 5

1. Relay Function

None: Non-latching, standard
U: Single-winding latching

2. Contact Form

2: DPDT

3. Terminal Shape

P: PCB through-hole terminals
FL: SMT Gull-wing
FS: SMT shortened leads

4. Packaging

None: Tube packaging
TR: Tape and reel packaging

9. Rated Coil Voltage

3, 4.5, 5, 12, 24

Application Examples

Communications equipment, measurement devices, computer peripheral devices, office automation equipment, and audio-visual products.

Specifications

■ Contact Data

Rated load	0.3 A @ 125 VAC 1 A @ 30 VDC
Contact material	Ag (Au Clad)
Max. carry current	1 A
Max. operating voltage	125 VAC, 110 VDC
Max. operating current	1 A
Max. switching capacity	37.5 VA, 30 W
Min. permissible load (see note)	10m VDC, 10 μ A

Note: This value was measured at a switching frequency of 120 operations/min and the criterion of contact resistance is 5% of the load impedance. This value may vary depending on the operating frequency, operating conditions, expected reliability level of the relay, etc. Always double-check relay suitability under actual load conditions.

■ Coil Data

G6J-Y Standard, Non-latching (G6J-2P-Y, G6J-2FS-Y, G6J-2FL-Y)

Rated voltage (VDC)	Rated current (mA)	Coil resistance (Ω)	Pick-up voltage	Drop-out voltage	Max. voltage	Power consumption (mW)
			% of rated voltage			
3	48.0	62.5	75% max.	10% min.	150% max.	140
4.5	32.6	137.9				
5	28.9	173.1				
12	12.3	976.8				
24	9.2	2,600.5				230

- Note:**
1. The rated current and coil resistance are measured at a coil temperature of 23°C with a tolerance of $\pm 10\%$.
 2. The operating characteristics are measured at a coil temperature of 23°C.
 3. The maximum voltage is the highest voltage that can be imposed on the Relay coil instantaneously.

G6JU-Y Single coil, Latching (G6JU-2P-Y, G6JU-2FL-Y, G6JU-2FS-Y)

Rated voltage (VDC)	Rated current (mA)	Coil resistance (Ω)	Set voltage	Reset voltage	Max. voltage	Power consumption (mW)
			% of rated voltage			
3	33.7	89.0	75% max.	75% max.	150% max.	100
4.5	22.0	204.3				
5	20.4	245.5				
12	9.0	1,329.2				

- Note:**
1. The rated current and coil resistance are measured at a coil temperature of 23°C with a tolerance of $\pm 10\%$.
 2. The operating characteristics are measured at a coil temperature of 23°C.
 3. The maximum voltage is the highest voltage that can be imposed on the Relay coil instantaneously.

■ Characteristics

Item	Standard non-latching relays G6J-2P-Y, G6J-2FS-Y, G6J-2FL-Y		Single coil latching relays G6JU-2P-Y, G6JU-2FS-Y, G6JU-2FL-Y	
	Contact resistance (See note 1)	100 mΩ max.		
Operating (set) time (See note 2)	3 ms max. (approx. 1.6 ms)			
Release (reset) time (See note 2)	3 ms max. (approx. 1.0 ms)		3 ms max. (approx. 0.9 ms)	
Minimum set/reset pulse width	---		10 ms min. (at 100% rated coil voltage)	
Insulation resistance (See note 3)	1,000 MΩ min. (at 500 VDC)			
Dielectric strength	1,500 VAC, 50/60 Hz for 1 min. between coil and contacts 1,000 VAC, 50/60 Hz for 1 min. between contacts of different polarity 750 VAC, 50/60 Hz for 1 min. between contacts of the same polarity			
Surge withstand voltage	2,500 VAC, (2 x 10 μs) between coil and contacts 1,500 VAC, (10 x 160 μs) between contacts of the same and different polarity			
Vibration	Mechanical durability	10 to 55 Hz, 5-mm double amplitude		
	Malfunction durability	10 to 55 Hz, 3.3-mm double amplitude		
Shock	Mechanical durability	1,000 m/s ² (approx. 100G)		
	Malfunction durability	750 m/s ² (approx. 75G)		
Service life	Mechanical	50,000,000 operations min. (at 36,000 operations/hour)		
	Electrical	100,000 operations min. (with a rated load at 1,800 operations/hour)		
Ambient temperature	-40 to 85°C with no icing or condensation			
Humidity	5% to 85% RH			
Weight	Approx. 1.0 g			

- Note:**
1. The contact resistance was measured with 10 mA at 1 VDC with a fall-of-potential method.
 2. Values in parentheses are typical values unless otherwise stated.
 3. The insulation resistance was measured with a 500-VDC Megger Tester applied to the same parts as those for checking the dielectric strength.
 4. The above values are initial values.

Characteristic Data

Maximum Switching Capacity

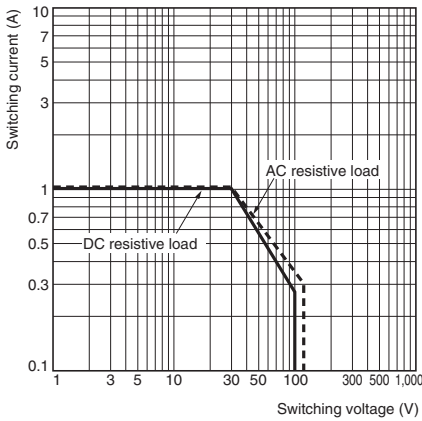

Ambient Temperature vs. Maximum Voltage

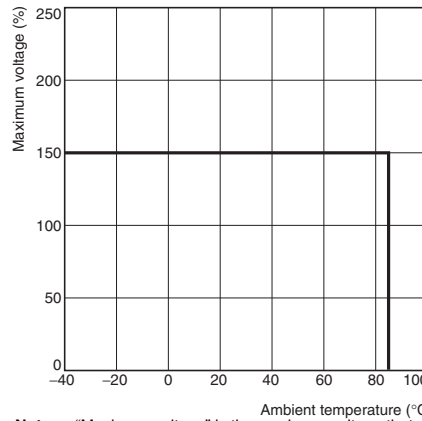

Note: "Maximum voltage" is the maximum voltage that can be applied to the Relay coil.

Ambient Temperature vs. Switching Current

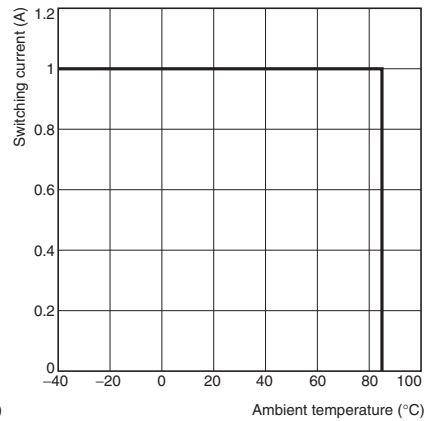

Electrical Life Expectancy

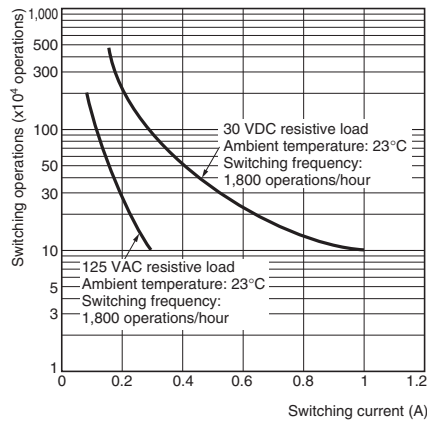

Ambient Temperature vs. Must Operate or Must Release Voltage

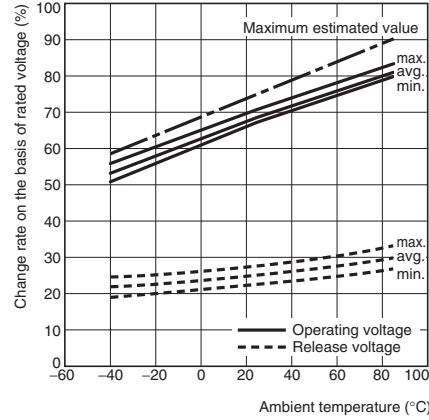

Shock Malfunction

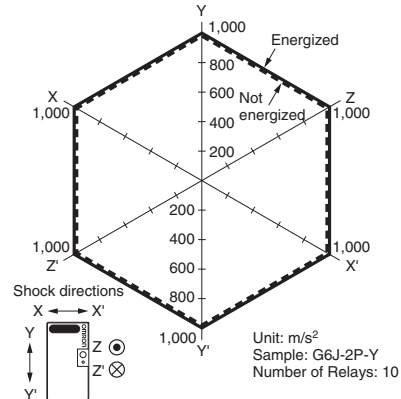

Conditions: Shock is applied in ±X, ±Y, and ±Z directions three times each with and without energizing the Relays to check the number of contact malfunctions.

Electrical Life Expectancy (with Must Operate and Must Release Voltage) (See note.)

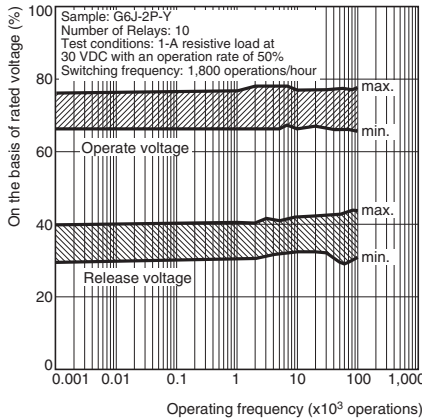

Electrical Life Expectancy (Contact resistance) (See note.)

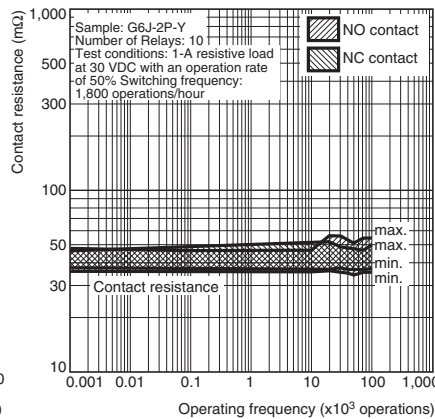

Contact Reliability Test (See note.)

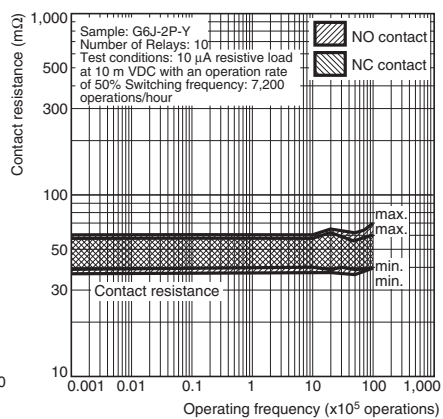

Note: 1. The tests were conducted at an ambient temperature of 23°C.
2. The contact resistance data are periodically measured reference values and are not values from each monitoring operation. Contact resistance values will vary according to the switching frequency and operating environment, so be sure to check operation under the actual operating conditions before use

Mutual Magnetic Interference

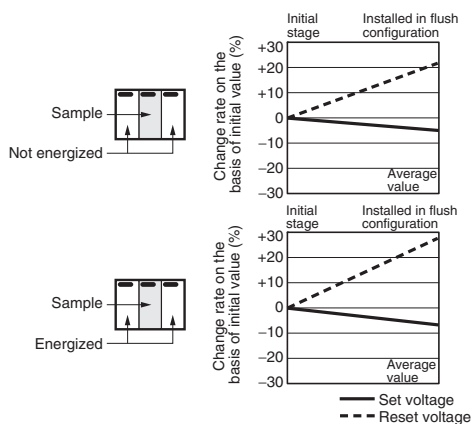

Mutual Magnetic Interference

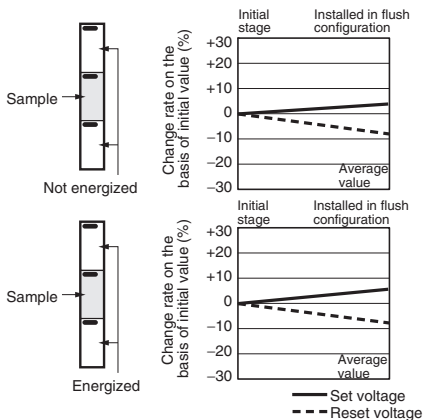

External Magnetic Interference

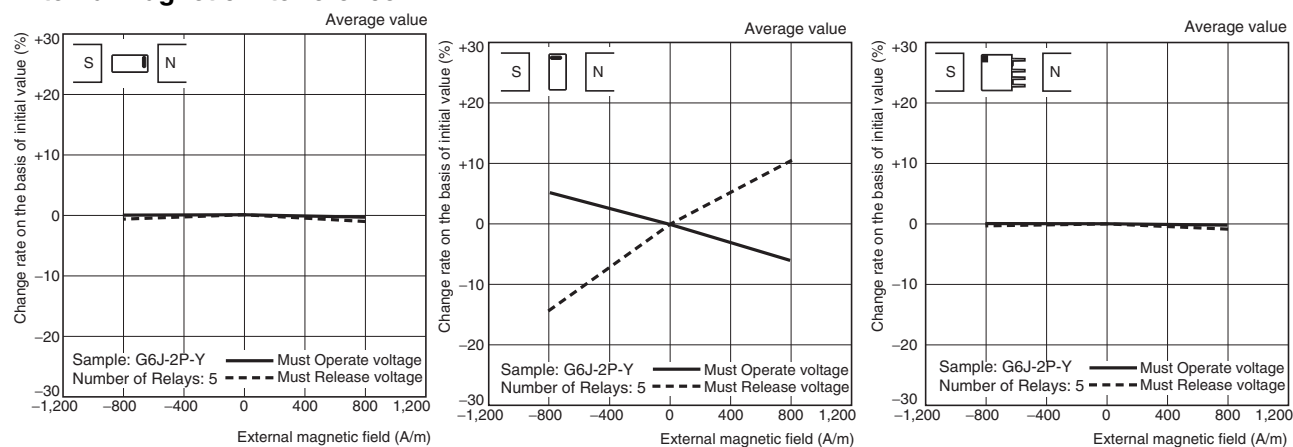

High-frequency Characteristics (Isolation)

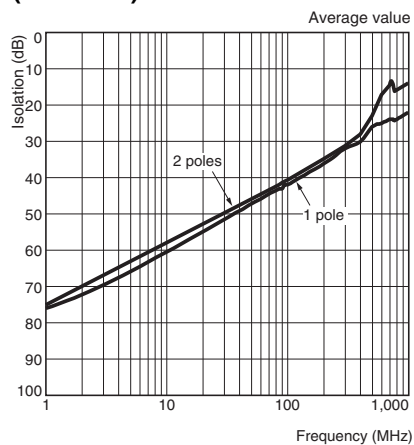

High-frequency Characteristics (Insertion Loss)

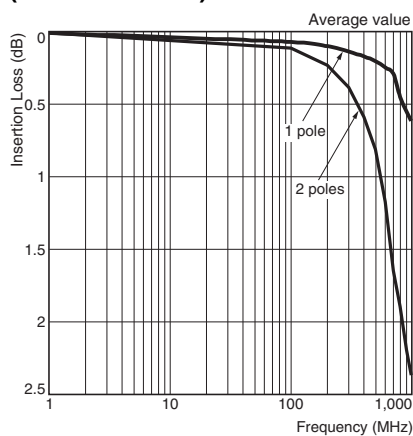

High-frequency Characteristics (Return Loss, V.SWR)

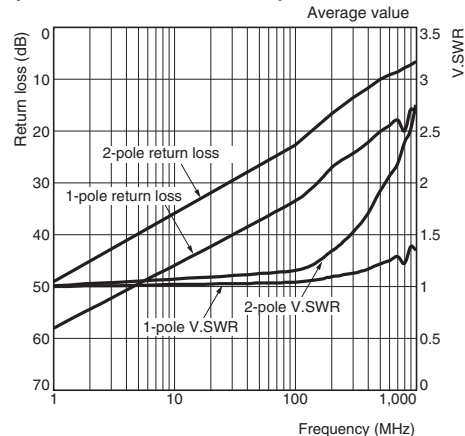

- Note:**
- The tests were conducted at an ambient temperature of 23°C.
 - High-frequency characteristics depend on the PCB to which the Relay is mounted. Always check these characteristics, including endurance, in the actual machine before use.

Must Operate and Must Release Time Distribution (See note.)

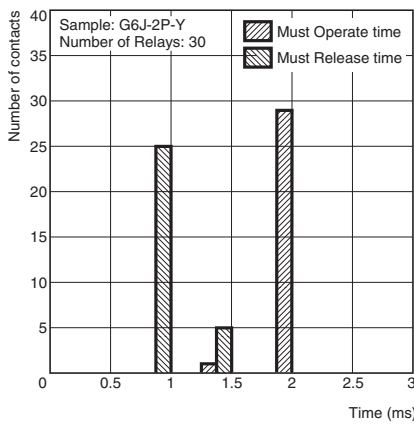

Must Operate and Must Release Bounce Time Distribution (See note.)

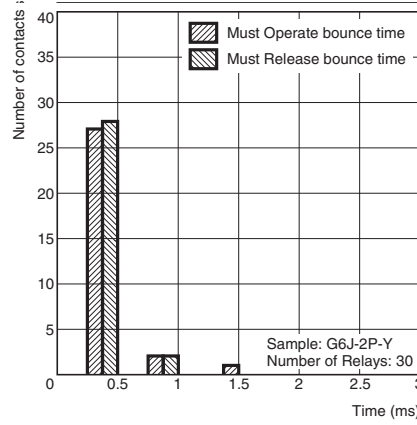

Vibration Resistance

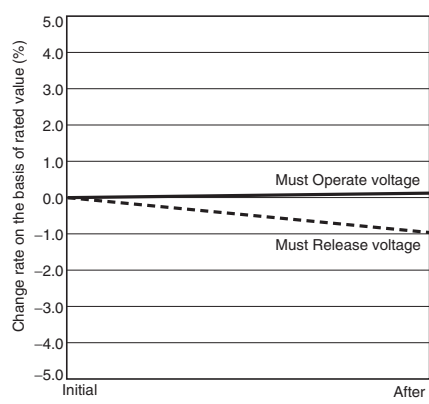

Note: The tests were conducted at an ambient temperature of 23°C.

Dimensions

Note: All units are in millimeters unless otherwise stated.

A tolerance of ± 0.3 (± 0.01) applies to every dimension in the following drawings unless otherwise stated.

G6J-2P-Y G6JU-2P-Y

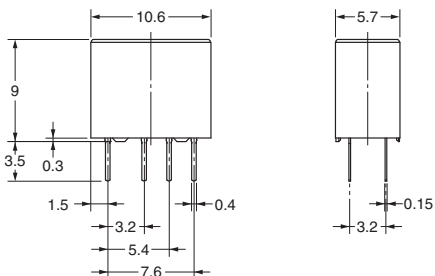
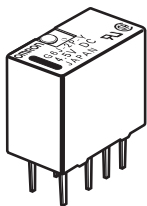

Mounting Dimensions (Bottom View)*

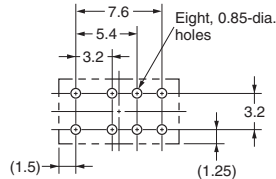

*Tolerance ± 0.1 mm

Terminal Arrangement Internal Connections (Bottom View)

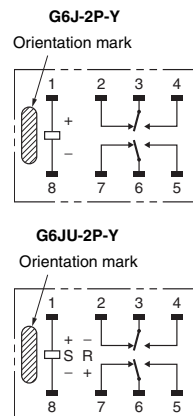

G6J-2FS-Y G6JU-2FS-Y

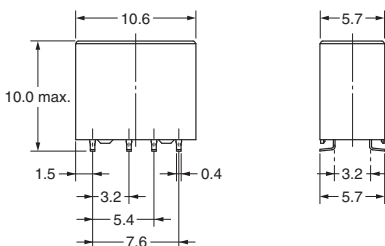
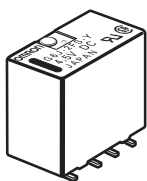

Mounting Dimensions (Top View)*

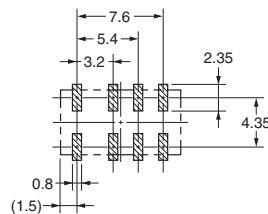

*Tolerance ± 0.1 mm

Terminal Arrangement/ Internal Connections (Top View)

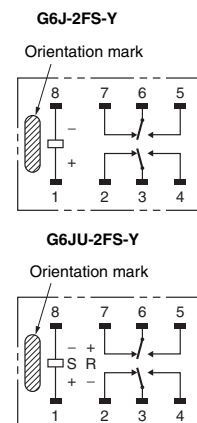

G6J-2FL-Y G6JU-2FL-Y

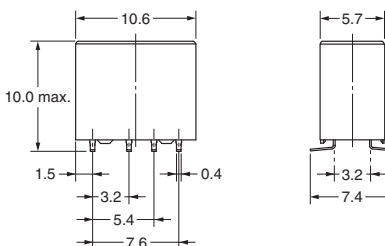
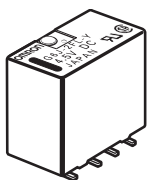

Mounting Dimensions (Top View)*

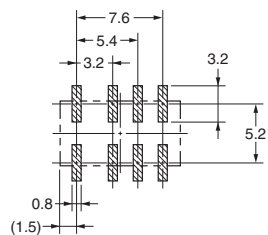

*Tolerance ± 0.1 mm

Terminal Arrangement/ Internal Connections (Top View)

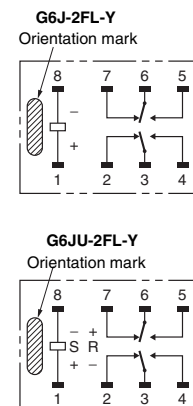

Stick Packing and Tape Packing

1. Stick Packing

Relays in stick packing are arranged so that the orientation mark of each Relay is on the left side.

Always confirm that the Relays are in the correct orientation when mounting the Relays to the PCBs.

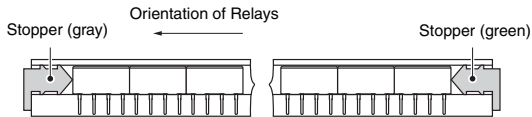

Stick length: 555 mm (stopper not included)

No. of Relays per stick: 50

2. Tape Packing (Surface-mounting Terminal Relays)

When ordering Relays in tape packing, add the prefix “-TR” to the model number, otherwise the Relays in stick packing will be provided.

Tape type: TB2412R (EIAJ (Electronic Industrial Association of Japan))

Reel type: R24D (EIAJ (Electronic Industrial Association of Japan))

Relays per reel: 400

Direction of Relay Insertion

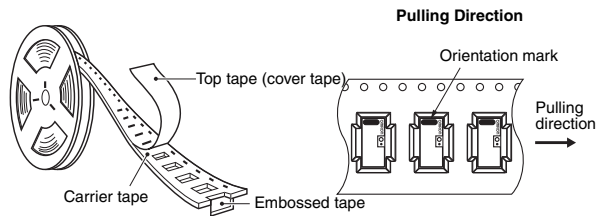

Reel Dimensions

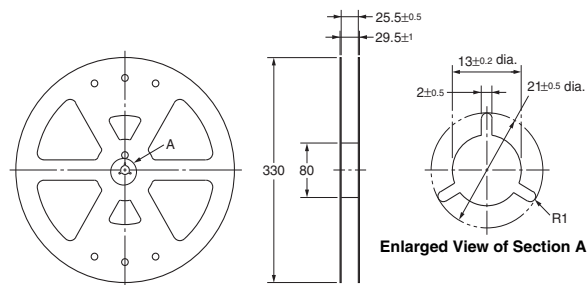

Carrier Tape Dimensions

G6J-2FS-Y, G6JU-2FS-Y

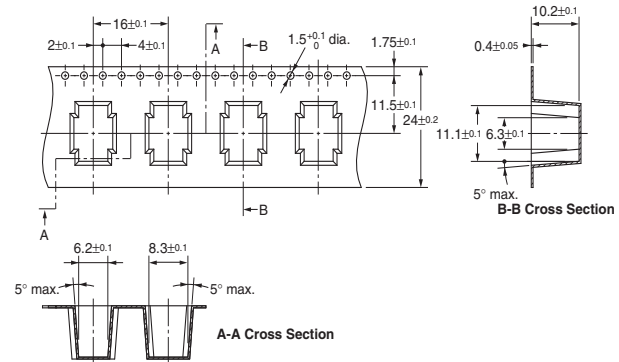

G6J-2FL-Y, G6JU-2FL-Y

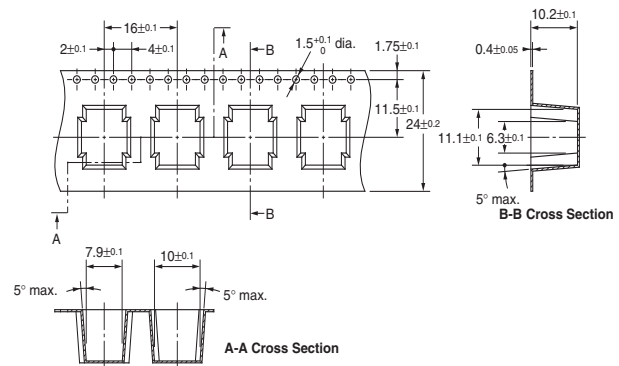

Recommended Soldering Method

IRS Method (for Surface-mounting Terminal Relays)

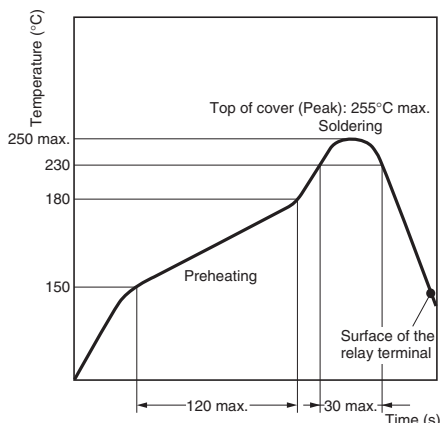

Note: Temperatures are given for the surface of the terminal.

- The thickness of cream solder to be applied should be between 150 and 200 μm on OMRON's recommended PCB pattern.
- In order to perform correct soldering, it is recommended that the correct soldering conditions be maintained as shown below on the left-hand side.

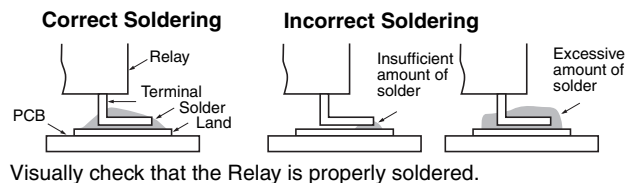

Visually check that the Relay is properly soldered.

■ Approved Standards

UL Recognized (File No. E41515) / CSA Certified (File No. LR31928) - - Ambient Temp. = 40°C

Contact form	Coil rating	Contact rating	Number of test operations
DPDT	G6J-2P-Y, 2FS-Y, 2FL-Y: 3 to 24 VDC G6JU-2P-Y, 2FS-Y, 2FL-Y: 3 to 24 VDC	1 A at 30 VDC (Resistive) 0.5 A at 60 VDC (Resistive) 0.3 A at 125 VAC (General purpose)	6000

Precautions

Correct Use

Long Term Current Carrying

Under a long-term current carrying without switching, the insulation resistance of the coil goes down gradually due to the heat generated by the coil itself. Furthermore, the contact resistance of the Relay will gradually become unstable due to the generation of film on the contact surfaces. A Latching Relay can be used to prevent these problems. When using a non-latching relay, the design of the fail-safe circuit provides protection against contact failure and open coils.

Handling of Surface-mounting Relays

Use the Relay as soon as possible after opening the moisture-proof package. If the Relay is left for a long time after opening the moisture-proof package, the appearance may suffer and seal failure may occur after the solder mounting process. To store the Relay after opening the moisture-proof package, place it into the original package and seal the package with adhesive tape.

When washing the product after soldering the Relay to a PCB, use a water-based solvent or alcohol-based solvent, and keep the solvent temperature at less than 40°C. Do not put the relay in a cold cleaning bath immediately after soldering.

Soldering

Solder: JIS Z3282, H63A

Soldering temperature: Approx. 250°C (At 260°C if the DWS method is used.)

Soldering time: Approx. 5 s max. (Approx. 2 s for the first time and approx. 3 s for the second time if the DWS method is used.)

Be sure to adjust the level of the molten solder so that the solder will not overflow onto the PCB.

Claw Securing Force During Automatic Insertion

During automatic insertion of Relays, make sure to set the securing force of the claws to the following values so that the Relay characteristics will be maintained.

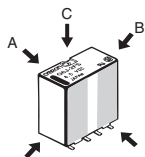

Direction A: 4.90 N max.

Direction B: 9.80 N max.

Direction C: 9.80 N max.

Secure the claws to the area indicated by shading. Do not attach them to the center area or to only part of the Relay.

Environmental Conditions During Operation, Storage, and Transportation

Protect the Relays from direct sunlight and keep the Relays under normal temperature, humidity, and pressure.

Mounting Latching Relays

The Latching Relays are reset before shipping. If excessive vibration or shock is imposed, however, the Latching Relays may be set accidentally. Be sure to apply a reset signal before use. Make sure that the vibration or shock that is generated by other devices on the same panel does not exceed the rated value of the Latching Relays.

Maximum Voltage

The maximum voltage of the coil can be obtained from the coil temperature increase and the heat-resisting temperature of coil insulating sheath material. (Exceeding the heat-resisting temperature may result in burning or short-circuiting.) The maximum voltage also involves important restrictions. Maximum voltage:

- must not cause thermal changes or deterioration of the insulating material.
- must not cause damage to other control devices.
- must not cause any harmful effect on people.
- must not cause fire.

Therefore, be sure not to exceed the maximum voltage specified in the catalog.

As a rule, the rated voltage must be applied to the coil. A voltage exceeding the rated value, however, can be applied to the coil provided that the voltage is less than the maximum voltage. It must be noted that continuous voltage application to the coil will cause a coil temperature increase which could deteriorate the coil insulation, shorten the relay's electrical life, or affect various characteristics of the relay.

Coating

Relays mounted on PCBs may be coated or washed. Do not apply coatings or detergents containing silicone.

Other Handling

Dropping the relay may impose excess shock that exceeds the specifications. Do not use any relay that has been dropped.



All sales are subject to Omron Electronic Components LLC standard terms and conditions of sale, which can be found at http://www.components.omron.com/components/web/webfiles.nsf/sales_terms.html

ALL DIMENSIONS SHOWN ARE IN MILLIMETERS.

To convert millimeters into inches, multiply by 0.03937. To convert grams into ounces, multiply by 0.03527.

OMRON[®]

**OMRON ELECTRONIC
COMPONENTS LLC**

55 E. Commerce Drive, Suite B
Schaumburg, IL 60173

847-882-2288

OMRON ON-LINE

Global - <http://www.omron.com>

USA - <http://www.components.omron.com>

Cat. No. X301-E-1b

09/11

Specifications subject to change without notice

Printed in USA



Компания «ЭлектроПласт» предлагает заключение долгосрочных отношений при поставках импортных электронных компонентов на взаимовыгодных условиях!

Наши преимущества:

- Оперативные поставки широкого спектра электронных компонентов отечественного и импортного производства напрямую от производителей и с крупнейших мировых складов;
- Поставка более 17-ти миллионов наименований электронных компонентов;
- Поставка сложных, дефицитных, либо снятых с производства позиций;
- Оперативные сроки поставки под заказ (от 5 рабочих дней);
- Экспресс доставка в любую точку России;
- Техническая поддержка проекта, помощь в подборе аналогов, поставка прототипов;
- Система менеджмента качества сертифицирована по Международному стандарту ISO 9001;
- Лицензия ФСБ на осуществление работ с использованием сведений, составляющих государственную тайну;
- Поставка специализированных компонентов (Xilinx, Altera, Analog Devices, Intersil, Interpoint, Microsemi, Aeroflex, Peregrine, Syfer, Eurofarad, Texas Instrument, Miteq, Cobham, E2V, MA-COM, Hittite, Mini-Circuits, General Dynamics и др.);

Помимо этого, одним из направлений компании «ЭлектроПласт» является направление «Источники питания». Мы предлагаем Вам помощь Конструкторского отдела:

- Подбор оптимального решения, техническое обоснование при выборе компонента;
- Подбор аналогов;
- Консультации по применению компонента;
- Поставка образцов и прототипов;
- Техническая поддержка проекта;
- Защита от снятия компонента с производства.



Как с нами связаться

Телефон: 8 (812) 309 58 32 (многоканальный)

Факс: 8 (812) 320-02-42

Электронная почта: org@eplast1.ru

Адрес: 198099, г. Санкт-Петербург, ул. Калинина, дом 2, корпус 4, литера А.