

GaAs MMIC VOLTAGE-VARIABLE ATTENUATOR, 5 - 30 GHz

Typical Applications

The HMC812LC4 is ideal for:

- Point-to-Point Radio
- VSAT Radio
- Test Instrumentation
- Microwave Sensors
- Military, ECM & Radar

Functional Diagram

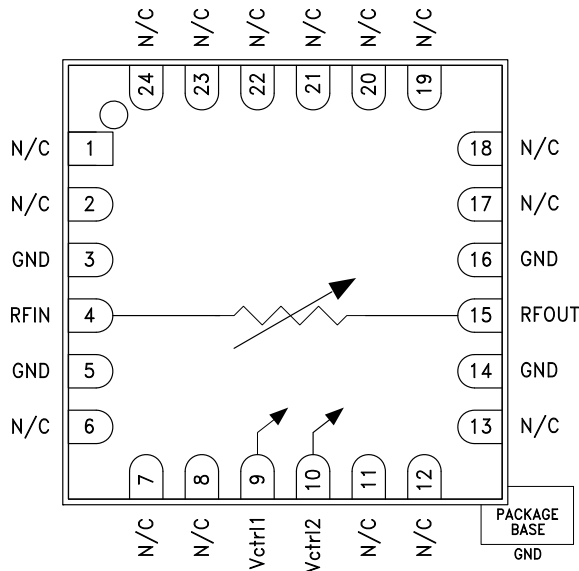

Features

- Wide Bandwidth: 5 - 30 GHz
- Excellent Linearity: +28 dBm Input IP3
- High Power Handling: +25 dBm Input P1dB
- Wide Attenuation Range: 30 dB
- 24 Lead Ceramic 4x4 mm SMT Package: 16mm²

General Description

The HMC812LC4 is an absorptive Voltage Variable Attenuator (VVA) which operates from 5 - 30 GHz and is ideal in designs where an analog DC control signal must be used to control RF signal levels over a 30 dB amplitude range. It features two shunt-type attenuators which are controlled by two analog voltages, Vctrl1 and Vctrl2. Optimum linearity performance of the attenuator is achieved by first varying Vctrl1 of the 1st attenuation stage from -3V to 0V with Vctrl2 fixed at -3V. The control voltage of the 2nd attenuation stage, Vctrl2, should then be varied from -3V to 0V, with Vctrl1 fixed at 0V. The HMC812LC4 is housed in a RoHS compliant 4x4 mm QFN leadless ceramic package

However, if the Vctrl1 and Vctrl2 pins are connected together it is possible to achieve the full analog attenuation range with only a small degradation in input IP3 performance. Applications include AGC circuits and temperature compensation of multiple gain stages in microwave point-to-point and VSAT radios.

Electrical Specifications, $T_A = +25^\circ C$, 50 Ohm system

Parameter	Min.	Typ.	Max.	Units
Insertion Loss		5 - 16 GHz	2	dB
		16 - 24 GHz	3	dB
		24 - 30 GHz	4	dB
Attenuation Range		30		dB
Input Return Loss		12		dB
Output Return Loss		8		dB
Input Power for 1 dB Compression (any attenuation)		25		dBm
Input Third Order Intercept (Two-tone Input Power = 10 dBm Each Tone)		28		dBm



GaAs MMIC VOLTAGE-VARIABLE ATTENUATOR, 5 - 30 GHz

Attenuation vs. Frequency over Vctrl
Vctrl1 = Variable, Vctrl2 = -3V

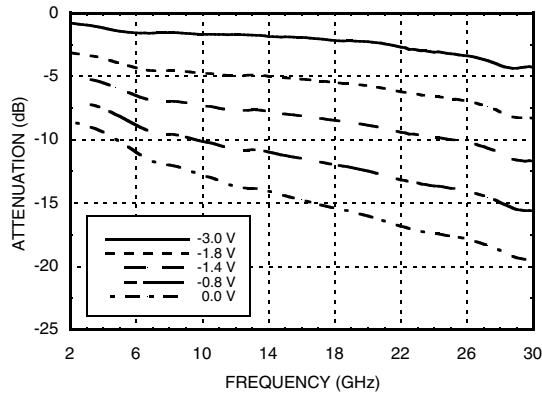

Attenuation vs. Frequency over Vctrl
Vctrl1 = 0V, Vctrl2 = Variable

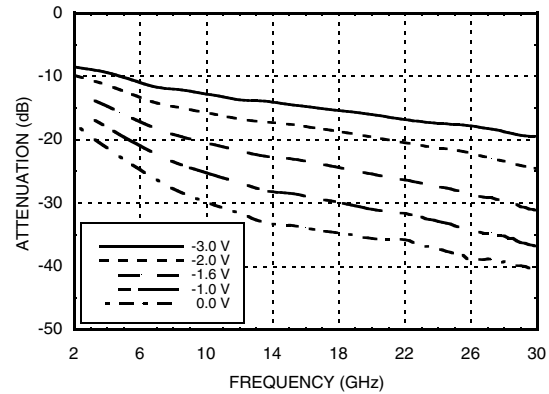

Attenuation vs. Vctrl1
Over Temperature @ 10 GHz, Vctrl2 = -3V

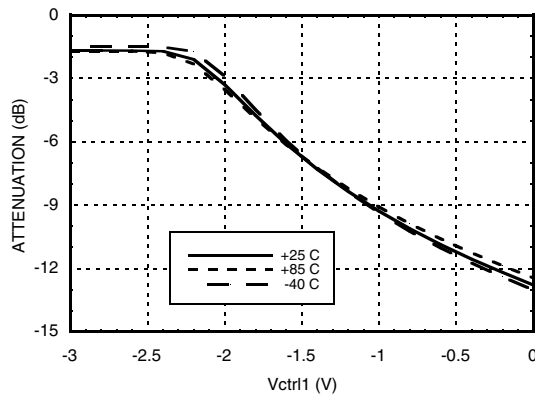

Attenuation vs. Vctrl2
Over Temperature @ 10 GHz, Vctrl1 = 0V

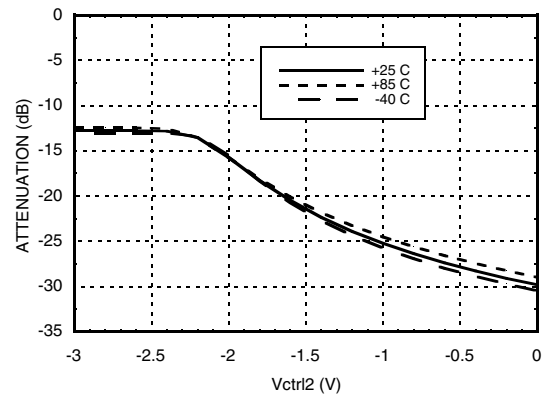

Attenuation vs. Pin @ 10 GHz
Vctrl1 = Variable, Vctrl2 = -3V

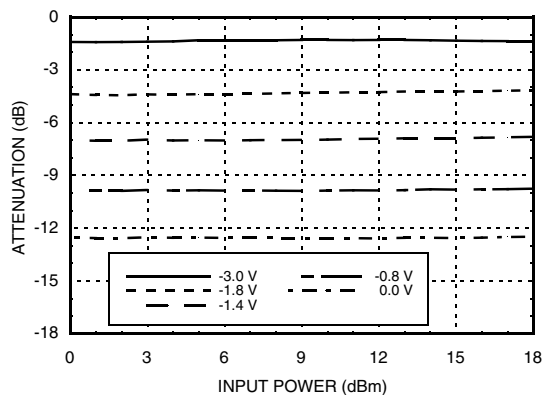

Input Return Loss
Vctrl1 = Variable, Vctrl2 = -3V

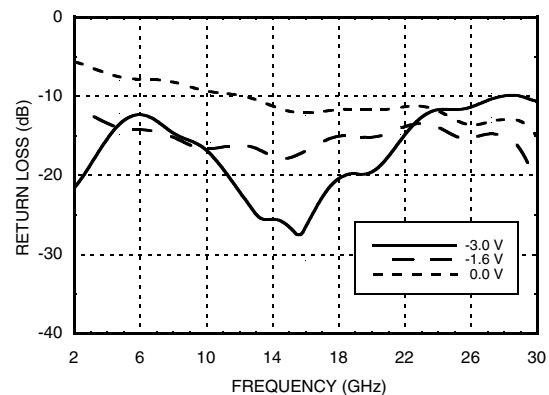



GaAs MMIC VOLTAGE-VARIABLE ATTENUATOR, 5 - 30 GHz

8

ATTENUATORS - ANALOG - SMT

Input Return Loss

Vctrl1 = 0V, Vctrl2 = Variable

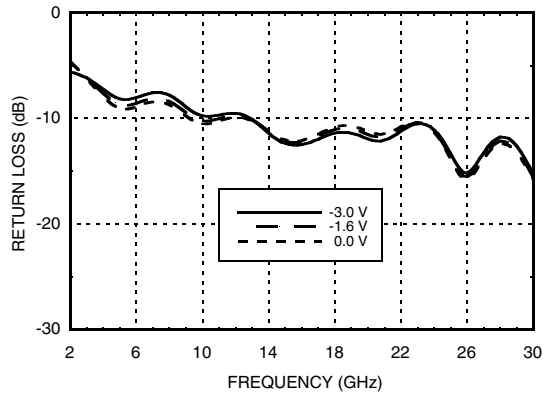

Output Return Loss

Vctrl1 = Variable, Vctrl2 = -3V

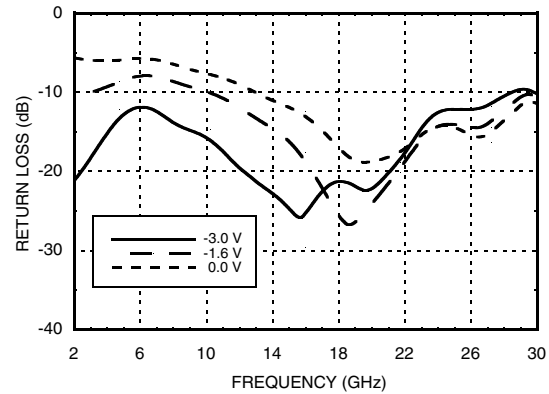

Output Return Loss

Vctrl1 = 0V, Vctrl2 = Variable

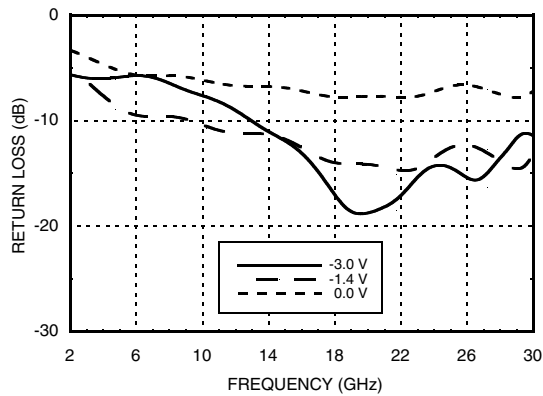

Input IP3 vs Input Power @ 10 GHz

Vctrl1 = Variable, Vctrl2 = -3V

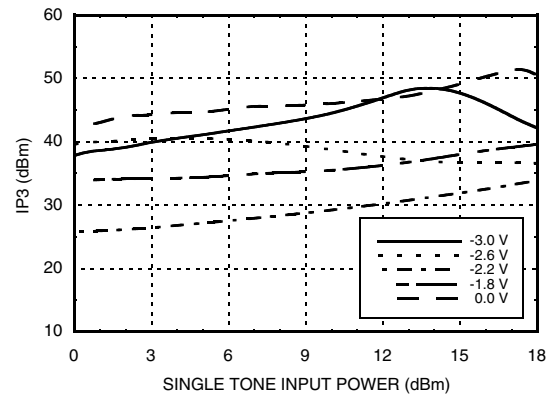

Input IP3 vs. Input Power Over Frequency

Vctrl1 = -2.2V, Vctrl2 = -3V (Worst Case IP3)

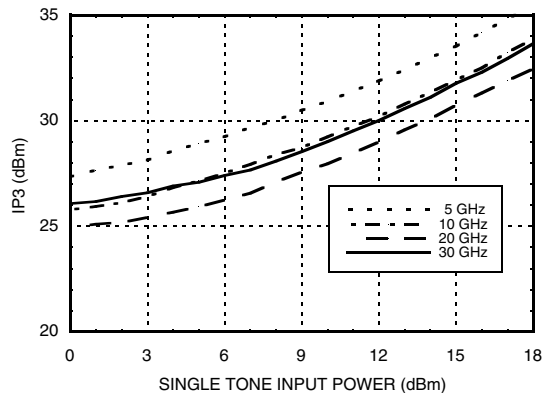

Input IP3 vs. Input Power Over Temperature

@ 10 GHz, Vctrl1 = -2.2V, Vctrl2 = -3V

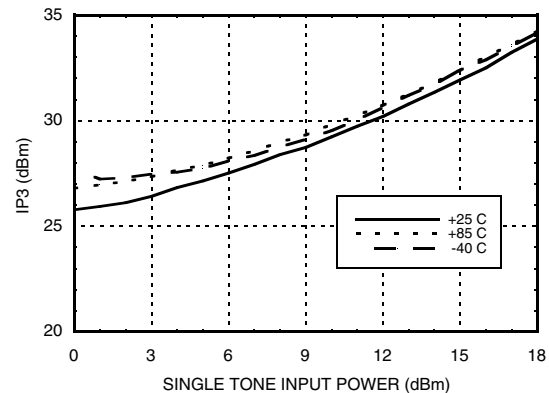

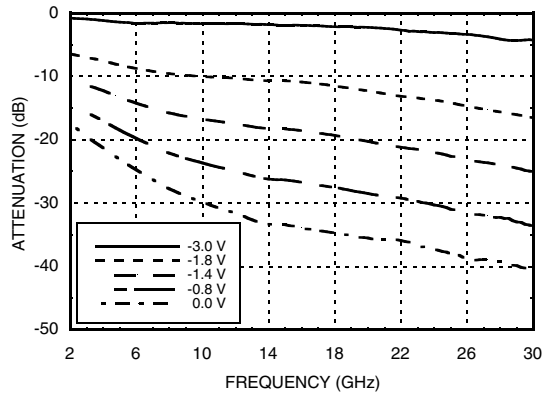
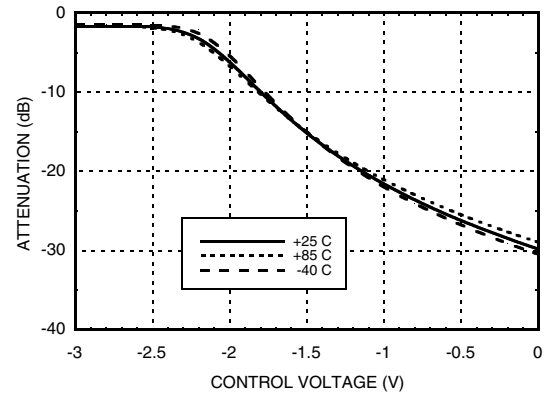
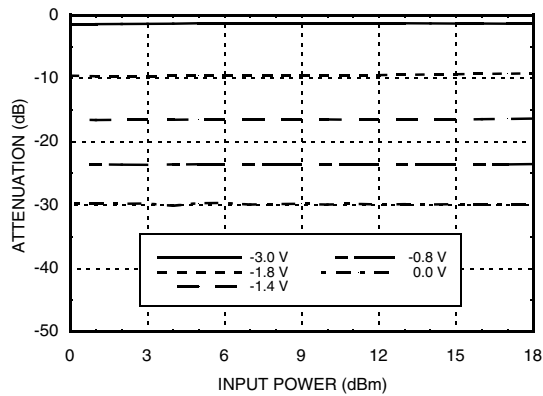
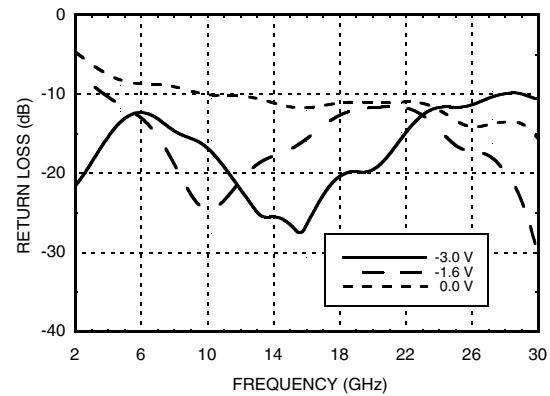
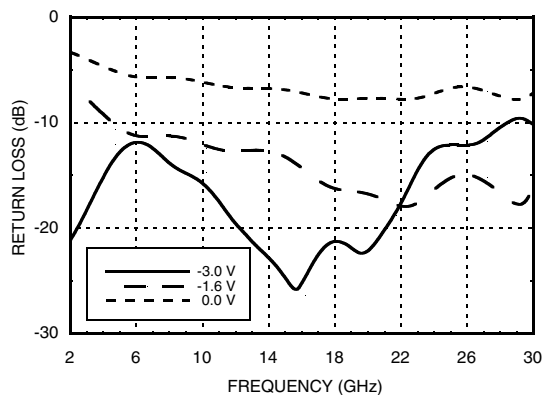
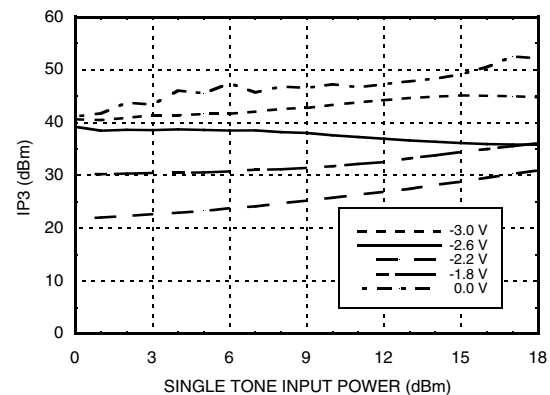

**GaAs MMIC VOLTAGE-VARIABLE
ATTENUATOR, 5 - 30 GHz**
**Attenuation vs. Frequency over Vctrl
Vctrl1 = Vctrl2**

**Attenuation vs. Vctrl over Temperature
@ 10 GHz, Vctrl1 = Vctrl2**

**Attenuation vs. Input Power over Vctrl
Vctrl1 = Vctrl2**

Input Return Loss, Vctrl1 = Vctrl2

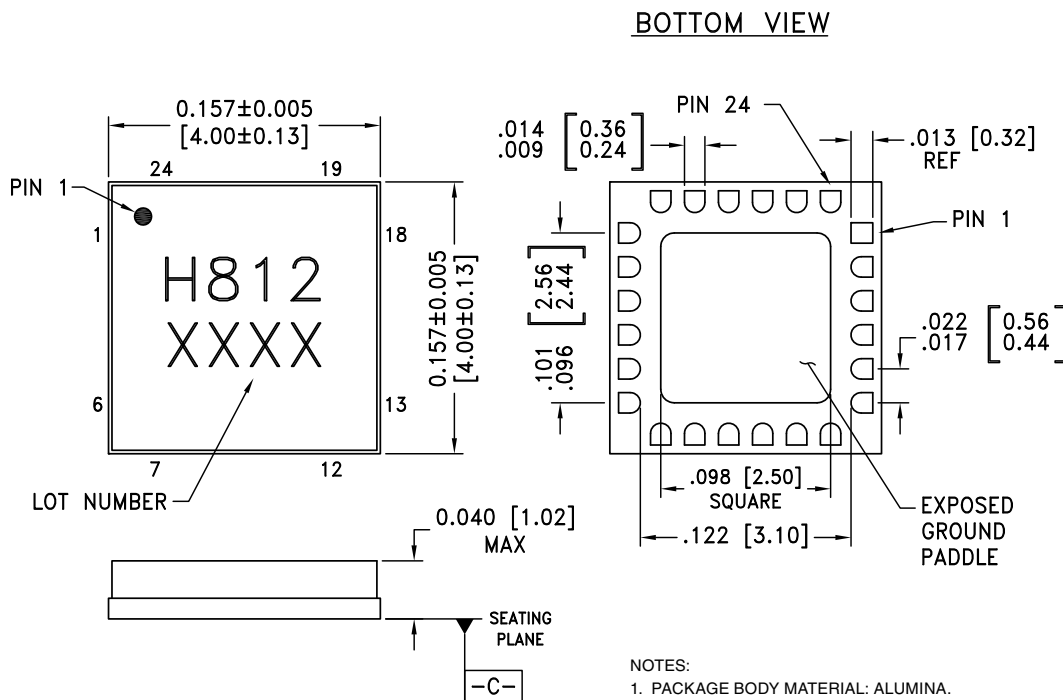
Output Return Loss, Vctrl1 = Vctrl2

**Input IP3 vs. Input Power Over
Vctrl @ 10 GHz, Vctrl1 = Vctrl2**

**GaAs MMIC VOLTAGE-VARIABLE
ATTENUATOR, 5 - 30 GHz**
Absolute Maximum Ratings

RF Input Power	+30 dBm
Control Voltage Range	+1 to -5V
Channel Temperature	150 °C
Continuous Pdiss (T = 85 °C) (derate 16.4 mW/ °C above 85 °C)	1.07 W
Thermal Resistance (Channel to ground paddle)	61 °C/W
Storage Temperature	-65 to +150 °C
Operating Temperature	-40 to +85 °C

Control Voltages

Vctrl1	-3 to 0V @ 10 μA
Vctrl2	-3 to 0V @ 10 μA

**ELECTROSTATIC SENSITIVE DEVICE
OBSERVE HANDLING PRECAUTIONS**
Outline Drawing

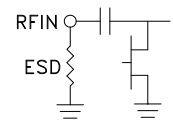
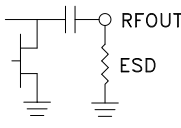
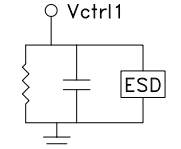
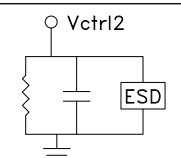

Pin Descriptions

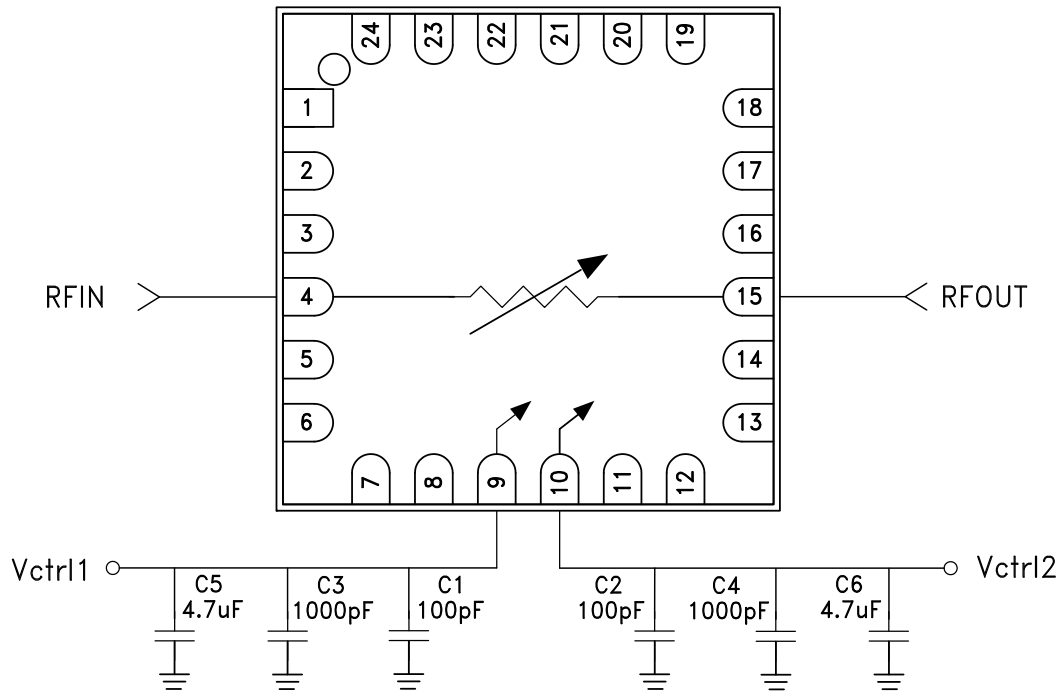
Pin Number	Function	Description	Interface Schematic
1, 2, 6 - 8, 11 - 13, 17 - 24	N/C	These pins are not connected internally, however these pins must be connected to RF/DC ground externally.	
3, 5, 14, 16	GND	These pins and the exposed ground paddle must be connected to RF/DC ground.	
4	RFIN	This pad is DC coupled and matched to 50 Ohms. A blocking capacitor is required if RF line potential is not equal to 0V.	
15	RFOUT		
9	Vctrl1	Control Voltage 1	
10	Vctrl2	Control Voltage 2	

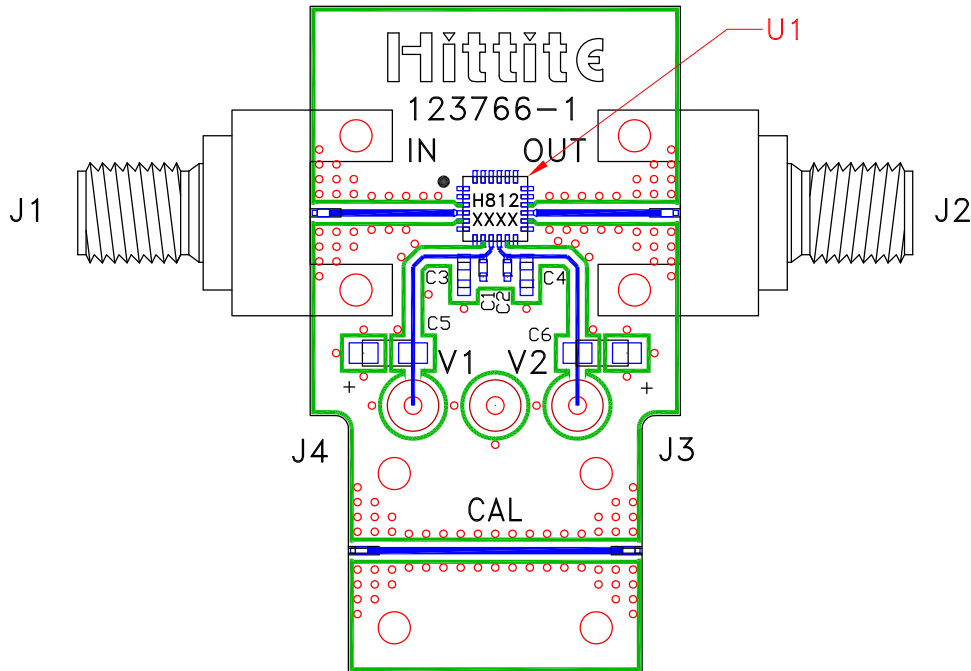
Application Circuit

Evaluation PCB

List of Materials for Evaluation PCB 123768 [1]

Item	Description
J1, J2	2.9 mm PC Mount RF Connector
J3, J4	DC Pin
C1, C2	100 pF Capacitor, 0402 Pkg.
C3, C4	1000 pF Capacitor, 0402 Pkg.
C5, C6	4.7 μ F Capacitor, CASE A
U1	HMC812LC4 Analog VVA
PCB [2]	123766 Evaluation PCB

[1] Reference this number when ordering complete evaluation PCB

[2] Circuit Board Material: Arlon 25FR or Rogers 4350

The circuit board used in the final application should use RF circuit design techniques. Signal lines should have 50 Ohm impedance while the package ground leads and exposed paddle should be connected directly to the ground plane similar to that shown. A sufficient number of via holes should be used to connect the top and bottom ground planes. The evaluation circuit board shown is available from Hittite upon request.



Компания «ЭлектроПласт» предлагает заключение долгосрочных отношений при поставках импортных электронных компонентов на взаимовыгодных условиях!

Наши преимущества:

- Оперативные поставки широкого спектра электронных компонентов отечественного и импортного производства напрямую от производителей и с крупнейших мировых складов;
- Поставка более 17-ти миллионов наименований электронных компонентов;
- Поставка сложных, дефицитных, либо снятых с производства позиций;
- Оперативные сроки поставки под заказ (от 5 рабочих дней);
- Экспресс доставка в любую точку России;
- Техническая поддержка проекта, помощь в подборе аналогов, поставка прототипов;
- Система менеджмента качества сертифицирована по Международному стандарту ISO 9001;
- Лицензия ФСБ на осуществление работ с использованием сведений, составляющих государственную тайну;
- Поставка специализированных компонентов (Xilinx, Altera, Analog Devices, Intersil, Interpoint, Microsemi, Aeroflex, Peregrine, Syfer, Eurofarad, Texas Instrument, Miteq, Cobham, E2V, MA-COM, Hittite, Mini-Circuits, General Dynamics и др.);

Помимо этого, одним из направлений компании «ЭлектроПласт» является направление «Источники питания». Мы предлагаем Вам помощь Конструкторского отдела:

- Подбор оптимального решения, техническое обоснование при выборе компонента;
- Подбор аналогов;
- Консультации по применению компонента;
- Поставка образцов и прототипов;
- Техническая поддержка проекта;
- Защита от снятия компонента с производства.



Как с нами связаться

Телефон: 8 (812) 309 58 32 (многоканальный)

Факс: 8 (812) 320-02-42

Электронная почта: org@eplast1.ru

Адрес: 198099, г. Санкт-Петербург, ул. Калинина, дом 2, корпус 4, литера А.