

REVISIONS			
REV	ECN, ERN NO.	DATE	APPRD.
D	PRODUCT DRAWING (EAR 14498)	NOV11/16	K.L.

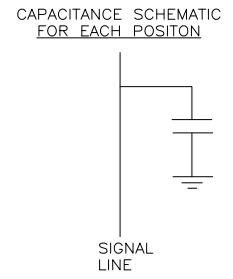
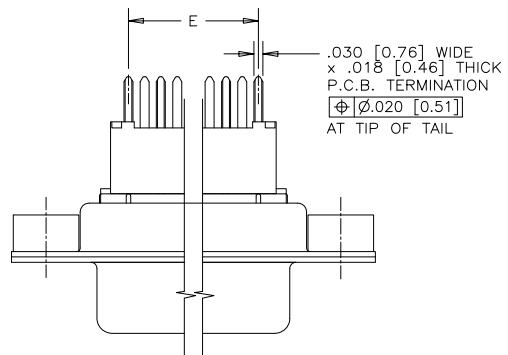

ORDERING CODE: **F C E 1 7 - E 0 9 P N - 2 E 0 G**

SERIES
FCE17=FILTERED D-SUB, RoHS

SIZE/NUMBER OF CONTACTS
E09, A15, B25, OR C37

CONNECTOR STYLE
P=PIN
S=SOCKET

TERMINATION TYPE
N=VERTICAL MOUNT PC TAIL,
.470 [11.94] FLANGE TO BOARD

MOUNTING
2=120[3.05] DIA THROUGH HOLE
3=#4-40 UNC SELF-LOCKING THREAD
4=#4-40 UNC THREAD
5=#4-40 THREADED STANDOFF
6=M3 x 0.5 THREAD
A=#4-40 THREADED STANDOFF
WITH BOARDLOCK
E=CODE 4 MOUNTING WITH #4-40 UNC
HEX JACK SOCKETS SUPPLIED
F=#4-40 FIXED FRONT JACK SOCKETS

CONTACT FINISH/GOLD THICKNESS
NO DIGIT=STANDARD 15 MICRONS
[0.38 MICRONS] GOLD ON MATING AREA
G=50 MICRONS [1.27 MICRONS] GOLD ON MATING AREA
K=30 MICRONS [0.76 MICRONS] GOLD ON MATING AREA

MODIFIER
O=STANDARD

FILTER CAPACITANCE
D=50 pF 5=1000 pF
B=100 pF 7=1200 pF
O=180 pF 6=1300 pF
F=330 pF J=1500 pF
L=380 pF E=2200 pF
1=470 pF 9=5600 pF
4=820 pF 8=47000 pF
N=NO FILTERS

REFER TO AMPHENOL CATALOGUE FOR FILTER PERFORMANCE CHARACTERISTICS

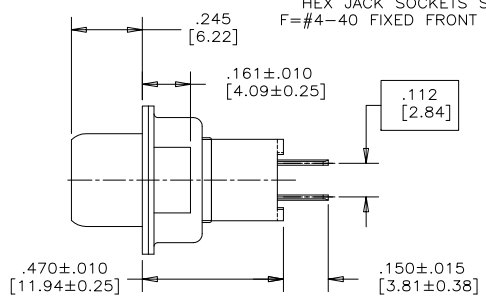
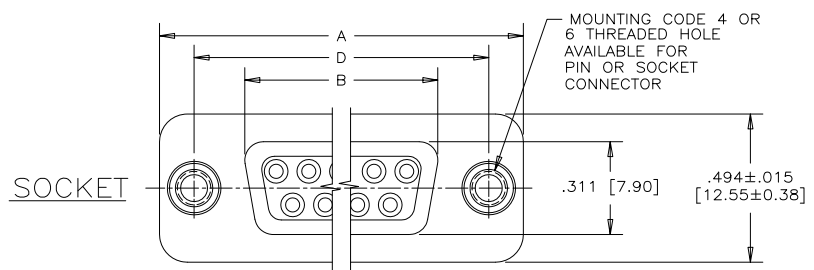

NOTES:

- MATERIALS: ALL MATERIALS ARE RoHS COMPLIANT.
 - SHELL: STEEL, TIN PLATED
 - CONTACTS: PHOSPHOR BRONZE, GOLD PLATED OVER 50µ" [1.27 MICRONS] NICKEL IN THE MATING AREA AND 100µ" [2.54 MICRONS] MIN. MATTE TIN ON THE TAILS.
 - INSULATOR: ENGINEERING THERMOPLASTIC, GLASS REINFORCED, UL FLAMMABILITY RATING 94V-0, COLOUR: BLACK
 - BOARDLOCK: COPPER ALLOY, TIN PLATED.
 - MOUNTING HARDWARE, STEEL OR COPPER ALLOY, TIN OR NICKEL PLATED.
- CONTACT RESISTANCE: 15 MILLIOHMS MAXIMUM
- INSULATION RESISTANCE: 3000 MEGOHMS MINIMUM
- CURRENT RATING: 5 AMPS MAXIMUM
- OPERATING TEMPERATURE: -40°C TO 85°C
- TOLERANCE ±.005 [0.13] UNLESS INDICATED OTHERWISE.

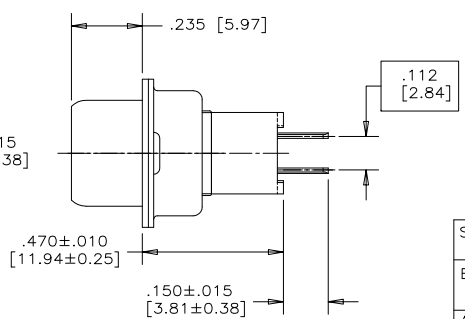
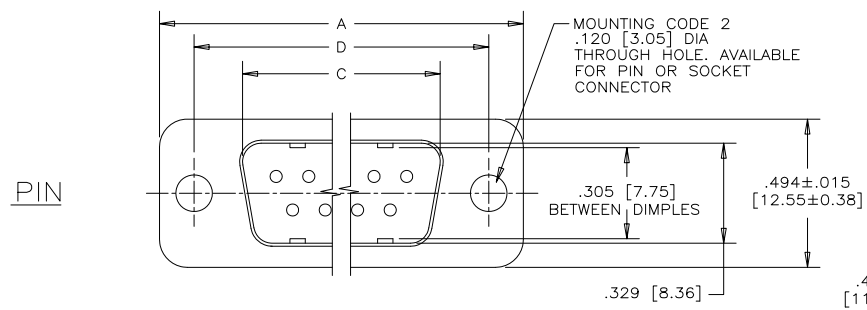

SIZE	STYLE	A±.015 [0.38]	B±.005 [0.13]	C±.005 [0.13]	D±.005 [0.13]	E BSC.
E09	PIN	1.213 [30.81]	-----	.666 [16.92]	.984 [24.99]	.432 [10.97]
	SOCKET	-----	.643 [16.33]	-----	-----	-----
A15	PIN	1.541 [39.14]	-----	.994 [25.25]	1.312 [33.32]	.756 [19.20]
	SOCKET	-----	.971 [24.66]	-----	-----	-----
B25	PIN	2.088 [53.04]	-----	1.534 [38.96]	1.852 [47.04]	1.304 [33.12]
	SOCKET	-----	1.511 [38.38]	-----	-----	-----
C37	PIN	2.729 [69.32]	-----	2.182 [55.42]	2.500 [63.50]	1.956 [49.68]
	SOCKET	-----	2.159 [54.84]	-----	-----	-----

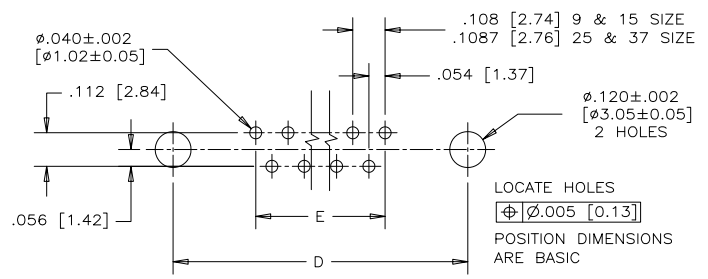

SEE SHEET 2 FOR ADDITIONAL MOUNTING OPTIONS

RECOMMENDED P.C.B. LAYOUT (COMPONENT SIDE OF BOARD)

DRAWN	A.CHENG	DATE	JAN12/06
DESIGNED			
CHECKED	K.LAMBIE	DATE	JAN12/06
I. E. APPRD.			
Q. A. APPRD.			
DWG. APPRD.			
ENG. REL. NO.			
REF.	EAR 12900		
DIMENSIONS ARE IN	INCHES [mm]	CODE ID. NO.	03554

Amphenol Canada Corp.

FCE17 SERIES FILTERED D-SUB CONNECTOR, PIN & SOCKET, VERTICAL MOUNT P.C.B. TAIL, .470 [11.94] FLANGE TO BOARD, RoHS COMPLIANT

DWG	DRAWING NO.	REV.
C	P-FCE17-XXXXN-XXOX	D
SCALE	3/1	WT. -----
SURF.	-----	SHEET 1 of 2

THIS DOCUMENT CONTAINS PROPRIETARY INFORMATION AND SUCH INFORMATION MAY NOT BE DISCLOSED TO OTHERS FOR ANY PURPOSE OR USED FOR MANUFACTURING PURPOSES WITHOUT WRITTEN PERMISSION FROM AMPHENOL CANADA CORP.

ADDITIONAL MOUNTING OPTIONS AVAILABLE FOR PIN OR SOCKET CONNECTOR

REVISIONS			
REV	ECN, ERN NO.	DATE	APPRD.
D	PRODUCT DRAWING (EAR 14498)	NOV11/16	K.L.

#4-40 UNC SELF-LOCKING THREAD

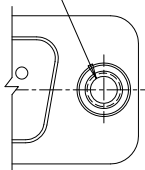

PARTIAL FRONT VIEW

MOUNTING CODE 3

.140 [3.56] MAX.

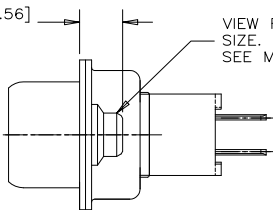

END VIEW

VIEW FOR E09, A15 & B25 SIZE. FOR C37 SIZE VIEW SEE MOUNTING CODE 4, SHEET 1.

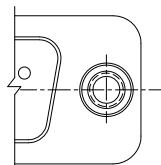

PARTIAL FRONT VIEW

MOUNTING CODE 5

4-40 THREADED THROUGH HOLE

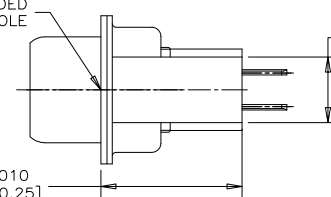

END VIEW

.219 [5.56] DIA. STANDOFF

.470±.010 [11.94±0.25]

2

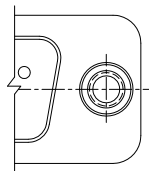

PARTIAL FRONT VIEW

MOUNTING CODE A

4-40 THREAD X .240 [6.10] MIN. DEEP

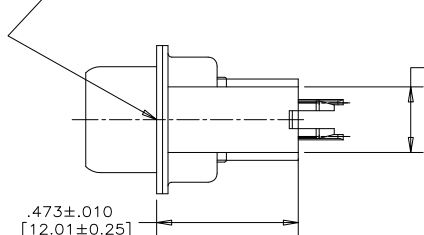

END VIEW

.219±.010 [5.56±0.25] DIA. STANDOFF WITH BOARDLOCK

.473±.010 [12.01±0.25]

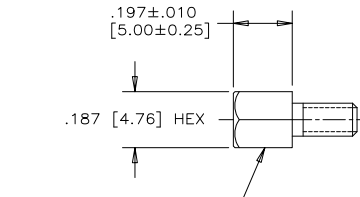

MOUNTING CODE E #4-40 UNC THREADED HEX JACK SOCKET (2 SUPPLIED PER CONNECTOR)

MOUNTING CODE E

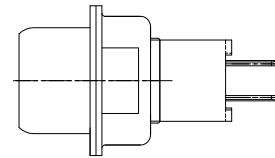

END VIEW

.197±.010 [5.00±0.25]

.187 [4.76] HEX

3

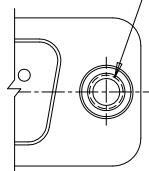

PARTIAL FRONT VIEW

MOUNTING CODE F

#4-40 UNC THREADED THROUGH HOLE

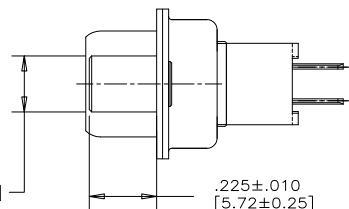

END VIEW

.187±.005 [4.75±0.13] DIA

.225±.010 [5.72±0.25]



DRAWN	A.CHENG	DATE	JAN12/06
DESIGNED			
CHECKED	K.LAMBIE	DATE	JAN12/06
I. E. APPRD.			
Q. A. APPRD.			
DWG. APPRD.			
ENG. REL. NO.			
REF.	EAR 12900		
DIMENSIONS ARE IN	INCHES [mm]	CODE ID. NO.	03554

Amphenol Canada Corp.

FCE17 SERIES FILTERED D-SUB CONNECTOR, PIN & SOCKET, VERTICAL MOUNT P.C.B. TAIL, .470 [11.94] FLANGE TO BOARD, RoHS COMPLIANT

DWG	DRAWING NO.	REV.
C	P-FCE17-XXXXN-XXOX	D
SCALE	3/1	WT. -----
SURF.	-----	SHEET 2 OF 2

THIS DOCUMENT CONTAINS PROPRIETARY INFORMATION AND SUCH INFORMATION MAY NOT BE DISCLOSED TO OTHERS FOR ANY PURPOSE OR USED FOR MANUFACTURING PURPOSES WITHOUT WRITTEN PERMISSION FROM AMPHENOL CANADA CORP.

A

B

C

D

E

F



Компания «ЭлектроПласт» предлагает заключение долгосрочных отношений при поставках импортных электронных компонентов на взаимовыгодных условиях!

Наши преимущества:

- Оперативные поставки широкого спектра электронных компонентов отечественного и импортного производства напрямую от производителей и с крупнейших мировых складов;
- Поставка более 17-ти миллионов наименований электронных компонентов;
- Поставка сложных, дефицитных, либо снятых с производства позиций;
- Оперативные сроки поставки под заказ (от 5 рабочих дней);
- Экспресс доставка в любую точку России;
- Техническая поддержка проекта, помощь в подборе аналогов, поставка прототипов;
- Система менеджмента качества сертифицирована по Международному стандарту ISO 9001;
- Лицензия ФСБ на осуществление работ с использованием сведений, составляющих государственную тайну;
- Поставка специализированных компонентов (Xilinx, Altera, Analog Devices, Intersil, Interpoint, Microsemi, Aeroflex, Peregrine, Syfer, Eurofarad, Texas Instrument, Miteq, Cobham, E2V, MA-COM, Hittite, Mini-Circuits, General Dynamics и др.);

Помимо этого, одним из направлений компании «ЭлектроПласт» является направление «Источники питания». Мы предлагаем Вам помощь Конструкторского отдела:

- Подбор оптимального решения, техническое обоснование при выборе компонента;
- Подбор аналогов;
- Консультации по применению компонента;
- Поставка образцов и прототипов;
- Техническая поддержка проекта;
- Защита от снятия компонента с производства.



Как с нами связаться

Телефон: 8 (812) 309 58 32 (многоканальный)

Факс: 8 (812) 320-02-42

Электронная почта: org@eplast1.ru

Адрес: 198099, г. Санкт-Петербург, ул. Калинина, дом 2, корпус 4, литера А.