

To our customers,

---

## Old Company Name in Catalogs and Other Documents

---

On April 1<sup>st</sup>, 2010, NEC Electronics Corporation merged with Renesas Technology Corporation, and Renesas Electronics Corporation took over all the business of both companies. Therefore, although the old company name remains in this document, it is a valid Renesas Electronics document. We appreciate your understanding.

Renesas Electronics website: <http://www.renesas.com>

April 1<sup>st</sup>, 2010  
Renesas Electronics Corporation

Issued by: Renesas Electronics Corporation (<http://www.renesas.com>)

Send any inquiries to <http://www.renesas.com/inquiry>.

## Notice

1. All information included in this document is current as of the date this document is issued. Such information, however, is subject to change without any prior notice. Before purchasing or using any Renesas Electronics products listed herein, please confirm the latest product information with a Renesas Electronics sales office. Also, please pay regular and careful attention to additional and different information to be disclosed by Renesas Electronics such as that disclosed through our website.
2. Renesas Electronics does not assume any liability for infringement of patents, copyrights, or other intellectual property rights of third parties by or arising from the use of Renesas Electronics products or technical information described in this document. No license, express, implied or otherwise, is granted hereby under any patents, copyrights or other intellectual property rights of Renesas Electronics or others.
3. You should not alter, modify, copy, or otherwise misappropriate any Renesas Electronics product, whether in whole or in part.
4. Descriptions of circuits, software and other related information in this document are provided only to illustrate the operation of semiconductor products and application examples. You are fully responsible for the incorporation of these circuits, software, and information in the design of your equipment. Renesas Electronics assumes no responsibility for any losses incurred by you or third parties arising from the use of these circuits, software, or information.
5. When exporting the products or technology described in this document, you should comply with the applicable export control laws and regulations and follow the procedures required by such laws and regulations. You should not use Renesas Electronics products or the technology described in this document for any purpose relating to military applications or use by the military, including but not limited to the development of weapons of mass destruction. Renesas Electronics products and technology may not be used for or incorporated into any products or systems whose manufacture, use, or sale is prohibited under any applicable domestic or foreign laws or regulations.
6. Renesas Electronics has used reasonable care in preparing the information included in this document, but Renesas Electronics does not warrant that such information is error free. Renesas Electronics assumes no liability whatsoever for any damages incurred by you resulting from errors in or omissions from the information included herein.
7. Renesas Electronics products are classified according to the following three quality grades: “Standard”, “High Quality”, and “Specific”. The recommended applications for each Renesas Electronics product depends on the product’s quality grade, as indicated below. You must check the quality grade of each Renesas Electronics product before using it in a particular application. You may not use any Renesas Electronics product for any application categorized as “Specific” without the prior written consent of Renesas Electronics. Further, you may not use any Renesas Electronics product for any application for which it is not intended without the prior written consent of Renesas Electronics. Renesas Electronics shall not be in any way liable for any damages or losses incurred by you or third parties arising from the use of any Renesas Electronics product for an application categorized as “Specific” or for which the product is not intended where you have failed to obtain the prior written consent of Renesas Electronics. The quality grade of each Renesas Electronics product is “Standard” unless otherwise expressly specified in a Renesas Electronics data sheets or data books, etc.
  - “Standard”: Computers; office equipment; communications equipment; test and measurement equipment; audio and visual equipment; home electronic appliances; machine tools; personal electronic equipment; and industrial robots.
  - “High Quality”: Transportation equipment (automobiles, trains, ships, etc.); traffic control systems; anti-disaster systems; anti-crime systems; safety equipment; and medical equipment not specifically designed for life support.
  - “Specific”: Aircraft; aerospace equipment; submersible repeaters; nuclear reactor control systems; medical equipment or systems for life support (e.g. artificial life support devices or systems), surgical implantations, or healthcare intervention (e.g. excision, etc.), and any other applications or purposes that pose a direct threat to human life.
8. You should use the Renesas Electronics products described in this document within the range specified by Renesas Electronics, especially with respect to the maximum rating, operating supply voltage range, movement power voltage range, heat radiation characteristics, installation and other product characteristics. Renesas Electronics shall have no liability for malfunctions or damages arising out of the use of Renesas Electronics products beyond such specified ranges.
9. Although Renesas Electronics endeavors to improve the quality and reliability of its products, semiconductor products have specific characteristics such as the occurrence of failure at a certain rate and malfunctions under certain use conditions. Further, Renesas Electronics products are not subject to radiation resistance design. Please be sure to implement safety measures to guard them against the possibility of physical injury, and injury or damage caused by fire in the event of the failure of a Renesas Electronics product, such as safety design for hardware and software including but not limited to redundancy, fire control and malfunction prevention, appropriate treatment for aging degradation or any other appropriate measures. Because the evaluation of microcomputer software alone is very difficult, please evaluate the safety of the final products or system manufactured by you.
10. Please contact a Renesas Electronics sales office for details as to environmental matters such as the environmental compatibility of each Renesas Electronics product. Please use Renesas Electronics products in compliance with all applicable laws and regulations that regulate the inclusion or use of controlled substances, including without limitation, the EU RoHS Directive. Renesas Electronics assumes no liability for damages or losses occurring as a result of your noncompliance with applicable laws and regulations.
11. This document may not be reproduced or duplicated, in any form, in whole or in part, without prior written consent of Renesas Electronics.
12. Please contact a Renesas Electronics sales office if you have any questions regarding the information contained in this document or Renesas Electronics products, or if you have any other inquiries.

(Note 1) “Renesas Electronics” as used in this document means Renesas Electronics Corporation and also includes its majority-owned subsidiaries.

(Note 2) “Renesas Electronics product(s)” means any product developed or manufactured by or for Renesas Electronics.

## **1. Overview**

This MCU is built using the high-performance silicon gate CMOS process using the R8C CPU core and is packaged in a 48-pin plastic molded LQFP. This MCU operates using sophisticated instructions featuring a high level of instruction efficiency. With 1 Mbyte of address space, it is capable of executing instructions at high speed. This Furthermore, the data flash (1 KB x 2 blocks) is embedded in the R8C/21 Group.

The difference between R8C/20 and R8C/21 Groups is only the existence of the data flash. Their peripheral functions are the same.

### **1.1 Applications**

Automotive, etc.

## 1.2 Performance Overview

Table 1.1 outlines the Functions and Specifications for R8C/20 Group and Table 1.2 outlines the Functions and Specifications for R8C/21 Group.

**Table 1.1 Functions and Specifications for R8C/20 Group**

|                               | Item                                | Specification   |
|-------------------------------|-------------------------------------|---|
| CPU                           | Number of fundamental instructions  | 89 instructions   |
|                               | Minimum instruction execution time  | 50 ns ( $f(XIN) = 20$ MHz, $VCC = 3.0$ to $5.5$ V)<br>100 ns ( $f(XIN) = 10$ MHz, $VCC = 2.7$ to $5.5$ V)   |
|                               | Operating mode                      | Single-chip   |
|                               | Address space                       | 1 Mbyte   |
|                               | Memory capacity                     | Refer to <b>Table 1.3 Product Information for R8C/20 Group</b>  |
| Peripheral Function           | Ports                               | I/O ports: 41 pins, Input port: 3 pins  |
|                               | Timers                              | Timer RA: 8 bits x 1 channel,<br>Timer RB: 8 bits x 1 channel<br>(Each timer equipped with 8-bit prescaler)<br>Timer RD: 16 bits x 2 channel<br>(Circuits of input capture and output compare)<br>Timer RE: With compare match function |
|                               | Serial interface                    | 1 channel (UART0)<br>Clock synchronous I/O, UART<br>1 channel (UART1)<br>UART   |
|                               | Clock synchronous serial interface  | 1 channel<br>I <sup>2</sup> C bus interface <sup>(2)</sup> , Clock synchronous serial I/O with chip select  |
|                               | LIN module                          | Hardware LIN: 1 channel<br>(timer RA, UART0)  |
|                               | A/D converter                       | 10-bit A/D converter: 1 circuit, 12 channels  |
|                               | Watchdog timer                      | 15 bits x 1 channel (with prescaler)<br>Reset start selectable  |
|                               | Interrupt                           | Internal: 11 sources, External: 5 sources, Software: 4 sources,<br>Priority level: 7 levels   |
|                               | Clock generation circuits           | 2 circuits<br>XIN clock generation circuit (with on-chip feedback resistor)<br>On-chip oscillator (high speed, low speed)<br>High-speed on-chip oscillator has frequency adjustment function.   |
|                               | Oscillation stop detection function | Stop detection of XIN clock oscillation   |
|                               | Voltage detection circuit           | On-chip   |
|                               | Power-on reset circuit include      | On-chip   |
|                               | Electric Characteristics            | Supply voltage  |
| Current consumption           |                                     | Typ. 11.0 mA ( $VCC = 5$ V, $f(XIN) = 20$ MHz, High-speed on-chip oscillator stopping)<br>Typ. 5.3 mA ( $VCC = 5$ V, $f(XIN) = 10$ MHz, High-speed on-chip oscillator stopping)   |
| Flash Memory                  | Programming and erasure voltage     | $VCC = 2.7$ to $5.5$ V  |
|                               | Programming and erasure endurance   | 100 times   |
| Operating Ambient Temperature |                                     | -40 to 85°C   |
|                               |                                     | -40 to 125°C (option <sup>(1)</sup> )   |
| Package                       |                                     | 48-pin mold-plastic LQFP  |

### NOTES:

1. When using options, be sure to inquire about the specification.
2. I<sup>2</sup>C bus is a registered trademark of Koninklijke Philips Electronics N.V.

**Table 1.2 Functions and Specifications for R8C/21 Group**

| Item                          |                                     | Specification   |
|-------------------------------|-------------------------------------|---|
| CPU                           | Number of fundamental instructions  | 89 instructions   |
|                               | Minimum instruction execution time  | 50 ns (f(XIN) = 20 MHz, VCC = 3.0 to 5.5 V)<br>100 ns (f(XIN) = 10 MHz, VCC = 2.7 to 5.5 V)   |
|                               | Operating mode                      | Single-chip   |
|                               | Address space                       | 1 Mbyte   |
|                               | Memory capacity                     | Refer to <b>Table 1.4 Product Information for R8C/21 Group</b>  |
| Peripheral Function           | Ports                               | I/O ports: 41 pins, Input port: 3 pins  |
|                               | Timers                              | Timer RA: 8 bits x 1 channel,<br>Timer RB: 8 bits x 1 channel<br>(Each timer equipped with 8-bit prescaler)<br>Timer RD: 16 bits x 2 channel<br>(Circuits of input capture and output compare)<br>Timer RE: With compare match function |
|                               | Serial interface                    | 1 channel (UART0)<br>Clock synchronous I/O, UART<br>1 channel (UART1)<br>UART   |
|                               | Clock synchronous serial interface  | 1 channel<br>I <sup>2</sup> C bus interface <sup>(2)</sup> , Clock synchronous serial I/O with chip select  |
|                               | LIN module                          | Hardware LIN: 1 channel<br>(Timer RA, UART0)  |
|                               | A/D converter                       | 10-bit A/D converter: 1 circuit, 12 channels  |
|                               | Watchdog timer                      | 15 bits x 1 channel (with prescaler)<br>Reset start selectable  |
|                               | Interrupts                          | Internal: 11 sources, External: 5 sources, Software: 4 sources,<br>Priority level: 7 levels   |
|                               | Clock generation circuits           | 2 circuits<br>XIN clock generation circuit (with on-chip feedback resistor)<br>On-chip oscillator (high speed, low speed)<br>High-speed on-chip oscillator has frequency adjustment function.   |
|                               | Oscillation stop detection function | Stop detection of XIN clock oscillation   |
|                               | Voltage detection circuit           | On-chip   |
|                               | Power-on reset circuit include      | On-chip   |
|                               | Electric Characteristics            | Supply voltage  |
| Current consumption           |                                     | Typ. 11.0 mA (VCC = 5 V, f(XIN) = 20 MHz, High-speed on-chip oscillator stopping)<br>Typ. 5.3 mA (VCC = 5 V, f(XIN) = 10 MHz, High-speed on-chip oscillator stopping)   |
| Flash Memory                  | Programming and erasure voltage     | VCC = 2.7 to 5.5 V  |
|                               | Programming and erasure endurance   | 10,000 times (data flash)<br>1,000 times (program ROM)  |
| Operating Ambient Temperature |                                     | -40 to 85°C   |
|                               |                                     | -40 to 125°C (option <sup>(1)</sup> )   |
| Package                       |                                     | 48-pin mold-plastic LQFP  |

**NOTES:**

1. When using options, be sure to inquire about the specification.
2. I<sup>2</sup>C bus is a registered trademark of Koninklijke Philips Electronics N.V.

### 1.3 Block Diagram

Figure 1.1 shows a Block Diagram.

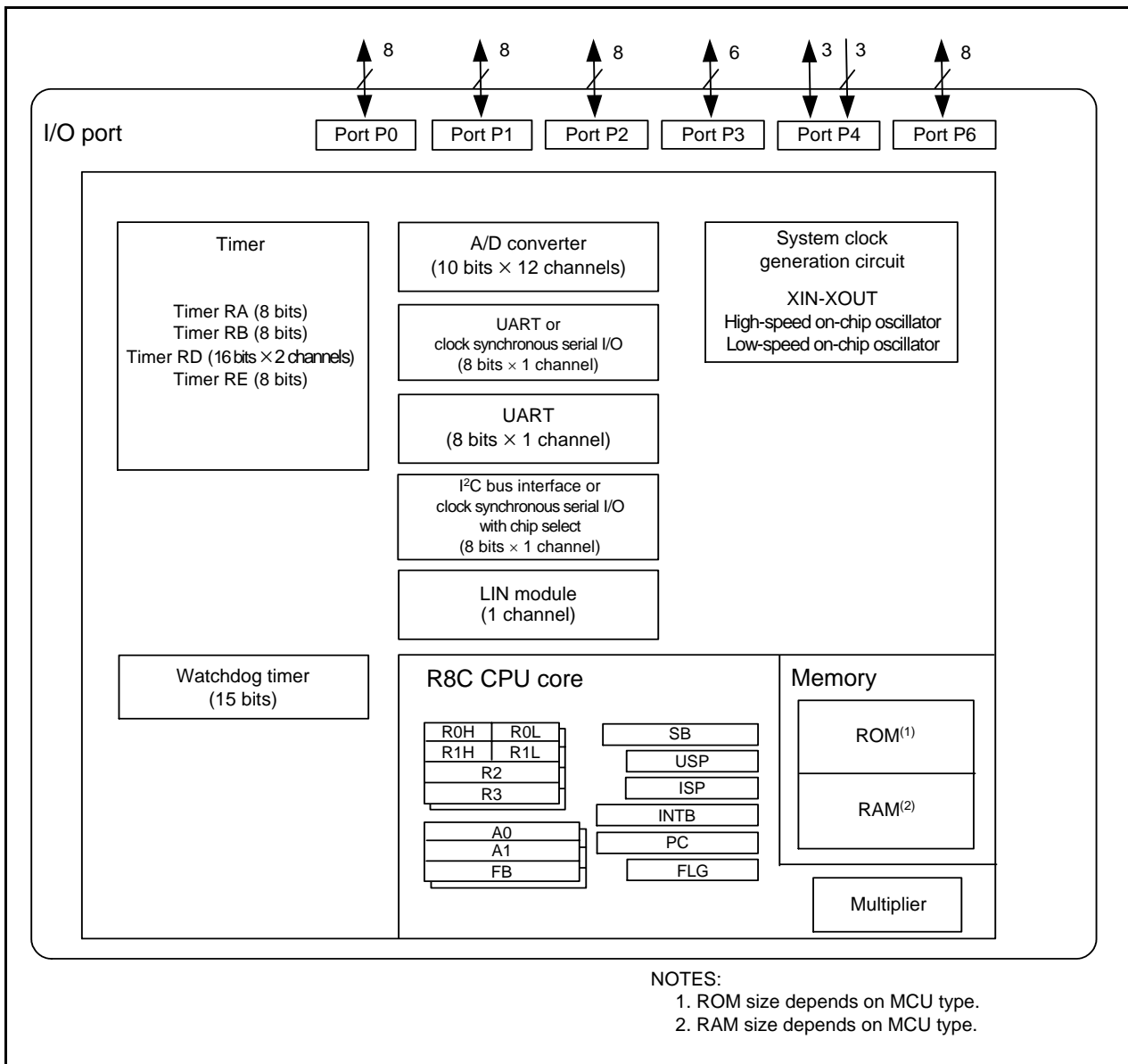

Figure 1.1 Block Diagram

## 1.4 Product Information

Table 1.3 lists Product Information for R8C/20 Group and Table 1.4 lists Product Information for R8C/21 Group.

**Table 1.3 Product Information for R8C/20 Group**

**Current of Aug. 2008**

| Type No.    | ROM Capacity              | RAM Capacity | Package Type | Remarks   |                      |
|-------------|---------------------------|--------------|--------------|-----------|----------------------|
| R5F21206JFP | 32 Kbytes                 | 2 Kbytes     | PLQP0048KB-A | J version | Flash memory version |
| R5F21207JFP | 48 Kbytes                 | 2.5 Kbytes   | PLQP0048KB-A |           |                      |
| R5F21208JFP | 64 Kbytes                 | 3 Kbytes     | PLQP0048KB-A |           |                      |
| R5F2120AJFP | 96 Kbytes                 | 5 Kbytes     | PLQP0048KB-A |           |                      |
| R5F2120CJFP | 128 Kbytes <sup>(1)</sup> | 6 Kbytes     | PLQP0048KB-A |           |                      |
| R5F21206KFP | 32 Kbytes                 | 2 Kbytes     | PLQP0048KB-A | K version |                      |
| R5F21207KFP | 48 Kbytes                 | 2.5 Kbytes   | PLQP0048KB-A |           |                      |
| R5F21208KFP | 64 Kbytes                 | 3 Kbytes     | PLQP0048KB-A |           |                      |
| R5F2120AKFP | 96 Kbytes                 | 5 Kbytes     | PLQP0048KB-A |           |                      |
| R5F2120CKFP | 128 Kbytes <sup>(1)</sup> | 6 Kbytes     | PLQP0048KB-A |           |                      |

**NOTE:**

- Do not use addresses 20000h to 23FFFh because these areas are used for the emulator debugger. Refer to **23. Notes on Emulator Debugger** of Hardware Manual.

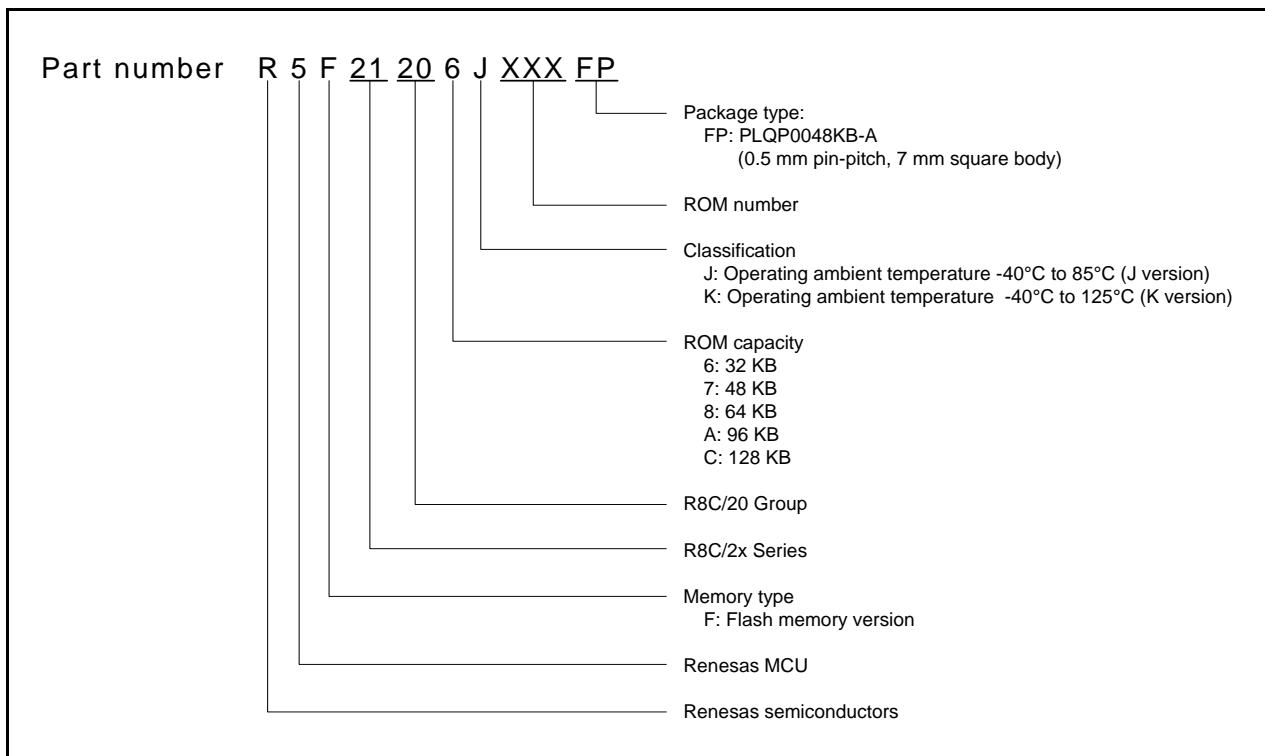

**Figure 1.2 Type Number, Memory Size, and Package of R8C/20 Group**

**Table 1.4 Product Information for R8C/21 Group** **Current of Aug. 2008**

| Type No.    | ROM Capacity              |             | RAM Capacity | Package Type | Remarks   |                      |
|-------------|---------------------------|-------------|--------------|--------------|-----------|----------------------|
|             | Program ROM               | Data Flash  |              |              |           |                      |
| R5F21216JFP | 32 Kbytes                 | 1 Kbyte X 2 | 2 Kbytes     | PLQP0048KB-A | J version | Flash memory version |
| R5F21217JFP | 48 Kbytes                 | 1 Kbyte X 2 | 2.5 Kbytes   | PLQP0048KB-A |           |                      |
| R5F21218JFP | 64 Kbytes                 | 1 Kbyte X 2 | 3 Kbytes     | PLQP0048KB-A |           |                      |
| R5F2121AJFP | 96 Kbytes                 | 1 Kbyte X 2 | 5 Kbytes     | PLQP0048KB-A |           |                      |
| R5F2121CJFP | 128 Kbytes <sup>(1)</sup> | 1 Kbyte X 2 | 6 Kbytes     | PLQP0048KB-A |           |                      |
| R5F21216KFP | 32 Kbytes                 | 1 Kbyte X 2 | 2 Kbytes     | PLQP0048KB-A | K version |                      |
| R5F21217KFP | 48 Kbytes                 | 1 Kbyte X 2 | 2.5 Kbytes   | PLQP0048KB-A |           |                      |
| R5F21218KFP | 64 Kbytes                 | 1 Kbyte X 2 | 3 Kbytes     | PLQP0048KB-A |           |                      |
| R5F2121AKFP | 96 Kbytes                 | 1 Kbyte X 2 | 5 Kbytes     | PLQP0048KB-A |           |                      |
| R5F2121CKFP | 128 Kbytes <sup>(1)</sup> | 1 Kbyte X 2 | 6 Kbytes     | PLQP0048KB-A |           |                      |

**NOTE:**

- Do not use addresses 20000h to 23FFFh because these areas are used for the emulator debugger. Refer to **23. Notes on Emulator Debugger** of Hardware Manual.

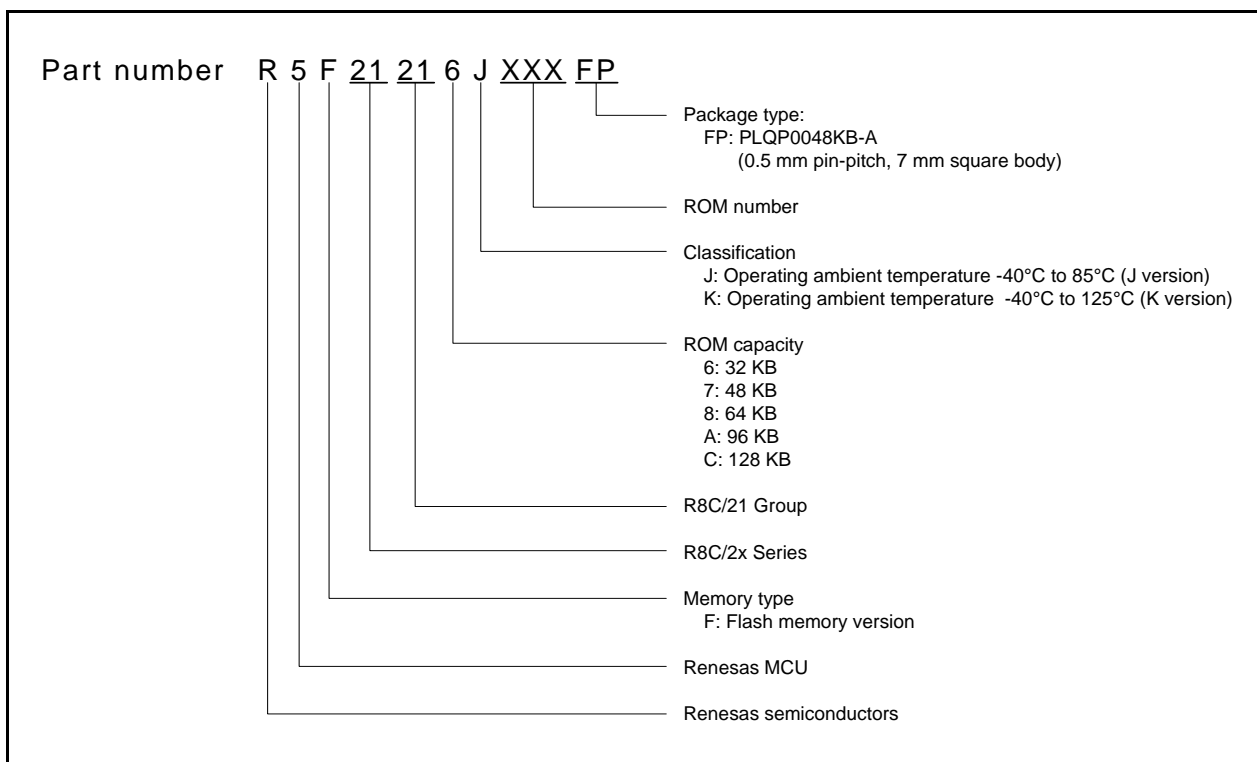
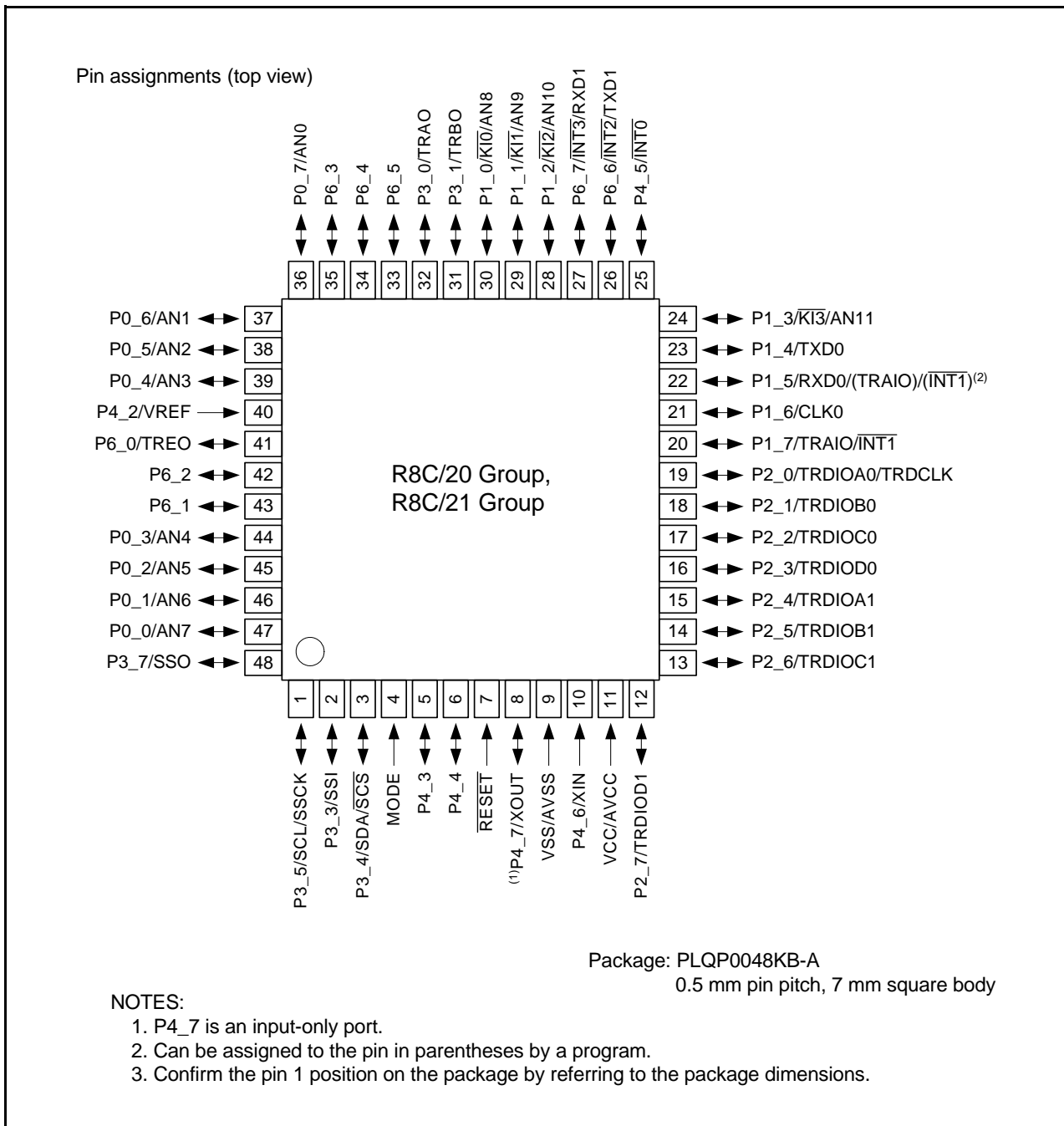

**Figure 1.3 Type Number, Memory Size, and Package of R8C/21 Group**



### 1.5 Pin Assignments

Figure 1.4 shows Pin Assignments (Top View).



**Figure 1.4 Pin Assignments (Top View)**

## 1.6 Pin Functions

Table 1.5 lists the Pin Functions and Table 1.6 lists the Pin Name Information by Pin Number.

**Table 1.5 Pin Functions**

| Type  | Symbol   | I/O Type | Description  |
|---|--|----------|--|
| Power Supply Input                            | VCC<br>VSS   | I        | Apply 2.7 V to 5.5 V to the VCC pin. Apply 0 V to the VSS pin.   |
| Analog Power Supply Input                     | AVCC, AVSS   | I        | Applies the power supply for the A/D converter. Connect a capacitor between AVCC and AVSS.   |
| Reset Input                                   | $\overline{\text{RESET}}$  | I        | Input "L" on this pin resets the MCU.  |
| MODE  | MODE   | I        | Connect this pin to VCC via a resistor.  |
| XIN Clock Input                               | XIN  | I        | These pins are provided for the XIN clock generation circuit I/O. Connect a ceramic resonator or a crystal oscillator between the XIN and XOUT pins. To use an externally derived clock, input it to the XIN pin and leave the XOUT pin open.            |
| XIN Clock Output                              | XOUT   | O        |  |
| $\overline{\text{INT}}$ Interrupt Input       | $\overline{\text{INT0}}$ to $\overline{\text{INT3}}$   | I        | $\overline{\text{INT}}$ interrupt input pins.<br>$\overline{\text{INT0}}$ Timer RD input pins.<br>$\overline{\text{INT1}}$ Timer RA input pins.  |
| Key Input Interrupt                           | $\overline{\text{KI0}}$ to $\overline{\text{KI3}}$   | I        | Key input interrupt input pins.  |
| Timer RA                                      | TRAIO  | I/O      | Timer RA I/O pin.  |
|   | TRAO   | O        | Timer RA output pin.   |
| Timer RB                                      | TRBO   | O        | Timer RB output pin.   |
| Timer RD                                      | TRDIOA0, TRDIOA1,<br>TRDIOB0, TRDIOB1,<br>TRDIOC0, TRDIOC1,<br>TRDIOD0, TRDIOD1  | I/O      | Timer RD I/O ports.  |
|   | TRDCLK   | I        | External clock input pin.  |
| Timer RE                                      | TREO   | O        | Divided clock output pin.  |
| Serial Interface                              | CLK0   | I/O      | Transfer clock I/O pin.  |
|   | RXD0, RXD1   | I        | Serial data input pins.  |
|   | TXD0, TXD1   | O        | Serial data output pins.   |
| I <sup>2</sup> C Bus Interface                | SCL  | I/O      | Clock I/O pin.   |
|   | SDA  | I/O      | Data I/O pin.  |
| Clock Synchronous Serial I/O with Chip Select | SSI  | I/O      | Data I/O pin.  |
|   | SCS  | I/O      | Chip-select signal I/O pin.  |
|   | SSCK   | I/O      | Clock I/O pin.   |
|   | SSO  | I/O      | Data I/O pin.  |
| Reference Voltage Input                       | VREF   | I        | Reference voltage input pin to A/D converter.  |
| A/D Converter                                 | AN0 to AN11  | I        | Analog input pins to A/D converter.  |
| I/O Port                                      | P0_0 to P0_7,<br>P1_0 to P1_7,<br>P2_0 to P2_7,<br>P3_0, P3_1,<br>P3_3 to P3_5, P3_7,<br>P4_3 to P4_5,<br>P6_0 to P6_7 | I/O      | CMOS I/O ports. Each port contains an input/output select direction register, allowing each pin in that port to be directed for input or output individually.<br>Any port set to input can select whether to use a pull-up resistor or not by a program. |
| Input Port                                    | P4_2, P4_6, P4_7   | I        | Input only ports.  |

I: Input    O: Output    I/O: Input and output

**Table 1.6 Pin Name Information by Pin Number**

| Pin Number | Control Pin | Port | I/O Pin Functions for of Peripheral Modules |                        |                  |   |                                |               |
|------------|-------------|------|---|------------------------|------------------|---|--------------------------------|---------------|
|            |             |      | Interrupt                                   | Timer                  | Serial Interface | Clock Synchronous Serial I/O with Chip Select | I <sup>2</sup> C Bus Interface | A/D Converter |
| 1          |             | P3_5 |   |                        |                  | SSCK  | SCL                            |               |
| 2          |             | P3_3 |   |                        |                  | SSI   |                                |               |
| 3          |             | P3_4 |   |                        |                  | SCS   | SDA                            |               |
| 4          | MODE        |      |   |                        |                  |   |                                |               |
| 5          |             | P4_3 |   |                        |                  |   |                                |               |
| 6          |             | P4_4 |   |                        |                  |   |                                |               |
| 7          | RESET       |      |   |                        |                  |   |                                |               |
| 8          | XOUT        | P4_7 |   |                        |                  |   |                                |               |
| 9          | VSS/AVSS    |      |   |                        |                  |   |                                |               |
| 10         | XIN         | P4_6 |   |                        |                  |   |                                |               |
| 11         | VCC/AVCC    |      |   |                        |                  |   |                                |               |
| 12         |             | P2_7 |   | TRDIOD1                |                  |   |                                |               |
| 13         |             | P2_6 |   | TRDIOC1                |                  |   |                                |               |
| 14         |             | P2_5 |   | TRDIQB1                |                  |   |                                |               |
| 15         |             | P2_4 |   | TRDIOA1                |                  |   |                                |               |
| 16         |             | P2_3 |   | TRDIOD0                |                  |   |                                |               |
| 17         |             | P2_2 |   | TRDIQC0                |                  |   |                                |               |
| 18         |             | P2_1 |   | TRDIQB0                |                  |   |                                |               |
| 19         |             | P2_0 |   | TRDIOA0/TRDCLK         |                  |   |                                |               |
| 20         |             | P1_7 | INT1  | TRAIO                  |                  |   |                                |               |
| 21         |             | P1_6 |   |                        | CLK0             |   |                                |               |
| 22         |             | P1_5 | (INT1) <sup>(1)</sup>                       | (TRAIO) <sup>(1)</sup> | RXD0             |   |                                |               |
| 23         |             | P1_4 |   |                        | TXD0             |   |                                |               |
| 24         |             | P1_3 | KI3   |                        |                  |   |                                | AN11          |
| 25         |             | P4_5 | INT0  | INT0                   |                  |   |                                |               |
| 26         |             | P6_6 | INT2  |                        | TXD1             |   |                                |               |
| 27         |             | P6_7 | INT3  |                        | RXD1             |   |                                |               |
| 28         |             | P1_2 | KI2   |                        |                  |   |                                | AN10          |
| 29         |             | P1_1 | KI1   |                        |                  |   |                                | AN9           |
| 30         |             | P1_0 | KI0   |                        |                  |   |                                | AN8           |
| 31         |             | P3_1 |   | TRBO                   |                  |   |                                |               |
| 32         |             | P3_0 |   | TRAQ                   |                  |   |                                |               |
| 33         |             | P6_5 |   |                        |                  |   |                                |               |
| 34         |             | P6_4 |   |                        |                  |   |                                |               |
| 35         |             | P6_3 |   |                        |                  |   |                                |               |
| 36         |             | P0_7 |   |                        |                  |   |                                | AN0           |
| 37         |             | P0_6 |   |                        |                  |   |                                | AN1           |
| 38         |             | P0_5 |   |                        |                  |   |                                | AN2           |
| 39         |             | P0_4 |   |                        |                  |   |                                | AN3           |
| 40         | VREF        | P4_2 |   |                        |                  |   |                                |               |
| 41         |             | P6_0 |   | TREO                   |                  |   |                                |               |
| 42         |             | P6_2 |   |                        |                  |   |                                |               |
| 43         |             | P6_1 |   |                        |                  |   |                                |               |
| 44         |             | P0_3 |   |                        |                  |   |                                | AN4           |
| 45         |             | P0_2 |   |                        |                  |   |                                | AN5           |
| 46         |             | P0_1 |   |                        |                  |   |                                | AN6           |
| 47         |             | P0_0 |   |                        |                  |   |                                | AN7           |
| 48         |             | P3_7 |   |                        |                  | SSQ   |                                |               |

NOTE:

1. Can be assigned to the pin in parentheses by a program.

## 2. Central Processing Unit (CPU)

Figure 2.1 shows the CPU Registers. The CPU contains 13 registers. Of these, R0, R1, R2, R3, A0, A1, and FB comprise a register bank. Two sets of register banks are provided.

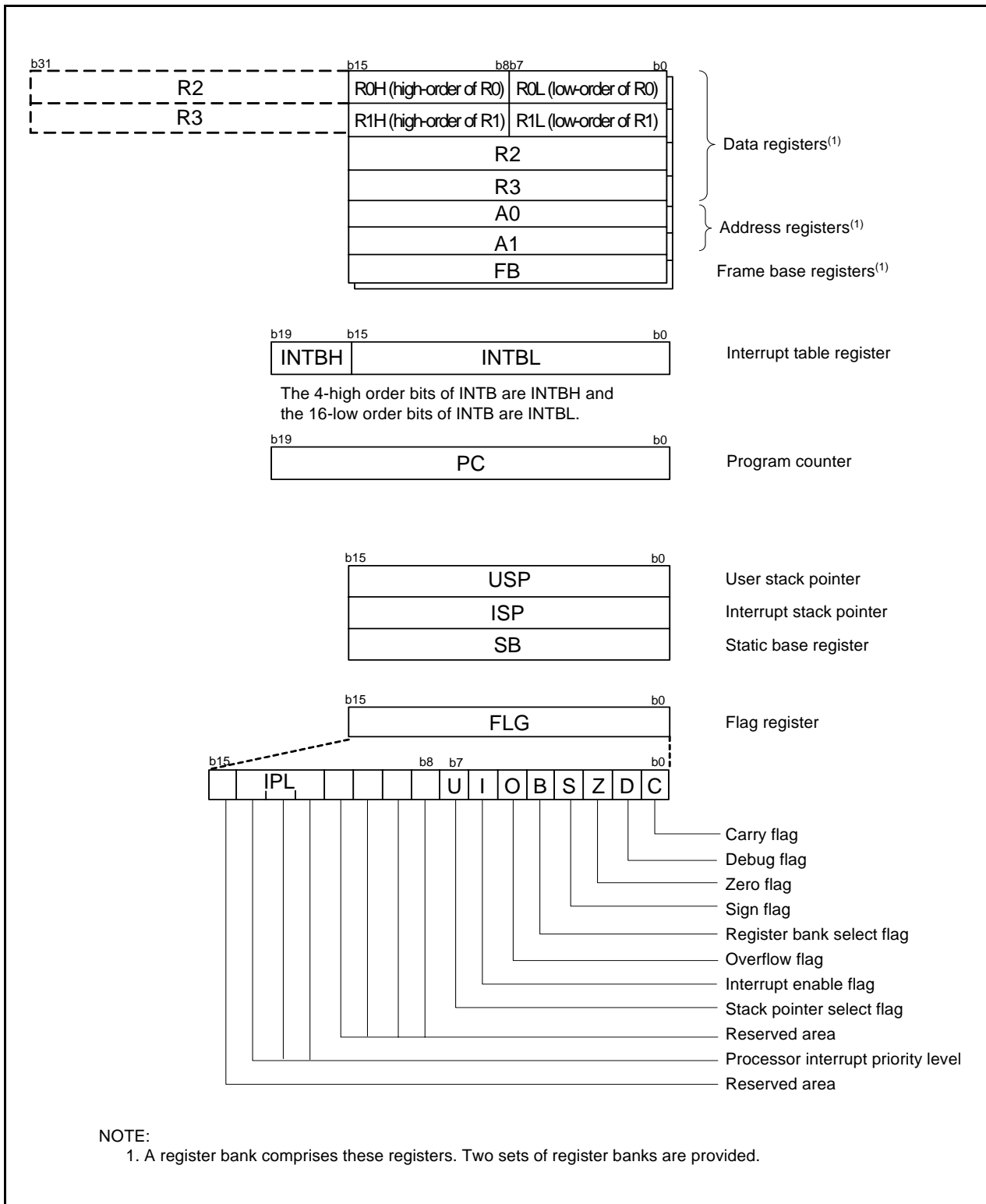

Figure 2.1 CPU Registers

## 2.1 Data Registers (R0, R1, R2 and R3)

R0 is a 16-bit register for transfer, arithmetic, and logic operations. The same applies to R1 to R3.

R0 can be split into high-order bit (R0H) and low-order bit (R0L) to be used separately as 8-bit data registers. The same applies to R1H and R1L as R0H and R0L. R2 can be combined with R0 to be used as a 32-bit data register (R2R0). The same applies R3R1 as R2R0.

## 2.2 Address Registers (A0 and A1)

A0 is a 16-bit register for address register indirect addressing and address register relative addressing. They also are used for transfer, arithmetic and logic operations. The same applies to A1 as A0.

A1 can be combined with A0 to be used a 32-bit address register (A1A0).

## 2.3 Frame Base Register (FB)

FB is a 16-bit register for FB relative addressing.

## 2.4 Interrupt Table Register (INTB)

INTB, a 20-bit register, indicates the start address of an interrupt vector table.

## 2.5 Program Counter (PC)

PC, 20 bits wide, indicates the address of an instruction to be executed.

## 2.6 User Stack Pointer (USP) and Interrupt Stack Pointer (ISP)

The stack pointer (SP), USP and ISP, are 16 bits wide each.

The U flag of FLG is used to switch between USP and ISP.

## 2.7 Static Base Register (SB)

SB is a 16-bit register for SB relative addressing.

## 2.8 Flag Register (FLG)

FLG is a 11-bit register indicating the CPU status.

### 2.8.1 Carry Flag (C)

The C flag retains a carry, borrow, or shift-out bit that has occurred in the arithmetic and logic unit.

### 2.8.2 Debug Flag (D)

The D flag is for debug only. Set to 0.

### 2.8.3 Zero Flag (Z)

The Z flag is set to 1 when an arithmetic operation resulted in 0; otherwise, 0.

### 2.8.4 Sign Flag (S)

The S flag is set to 1 when an arithmetic operation resulted in a negative value; otherwise, 0.

### 2.8.5 Register Bank Select Flag (B)

The register bank 0 is selected when the B flag is 0. The register bank 1 is selected when this flag is set to 1.

### 2.8.6 Overflow Flag (O)

The O flag is set to 1 when the operation resulted in an overflow; otherwise, 0.

### **2.8.7 Interrupt Enable Flag (I)**

The I flag enables a maskable interrupt.

An interrupt is disabled when the I flag is set to 0, and are enabled when the I flag is set to 1. The I flag is set to 0 when an interrupt request is acknowledged.

### **2.8.8 Stack Pointer Select Flag (U)**

ISP is selected when the U flag is set to 0; USP is selected when the U flag is set to 1.

The U flag is set to 0 when a hardware interrupt request is acknowledged or the INT instruction of software interrupt numbers. 0 to 31 is executed.

### **2.8.9 Processor Interrupt Priority Level (IPL)**

IPL, 3 bits wide, assigns processor interrupt priority levels from level 0 to level 7.

If a requested interrupt has greater priority than IPL, the interrupt is enabled.

### **2.8.10 Reserved Bit**

If necessary, set to 0. When read, the content is undefined.

## 3. Memory

### 3.1 R8C/20 Group

Figure 3.1 shows a Memory Map of R8C/20 Group. The R8C/20 Group has 1 Mbyte of address space from address 00000h to FFFFFFFh.

The internal ROM is allocated lower addresses, beginning with address 0FFFFh. For example, a 48-Kbyte internal ROM is allocated addresses 04000h to 0FFFFh.

The fixed interrupt vector table is allocated addresses 0FFDCh to 0FFFFh. They store the starting address of each interrupt routine.

The internal RAM is allocated higher addresses, beginning with address 00400h. For example, a 2.5-Kbyte internal RAM is allocated addresses 00400h to 00DFFh. The internal RAM is used not only for storing data but also for calling subroutines and as stacks when interrupt requests are acknowledged.

Special function registers (SFR) are allocated addresses 00000h to 002FFh. The peripheral function control registers are allocated here. All addresses within the SFR, which have nothing allocated are reserved for future user and cannot be accessed by users.

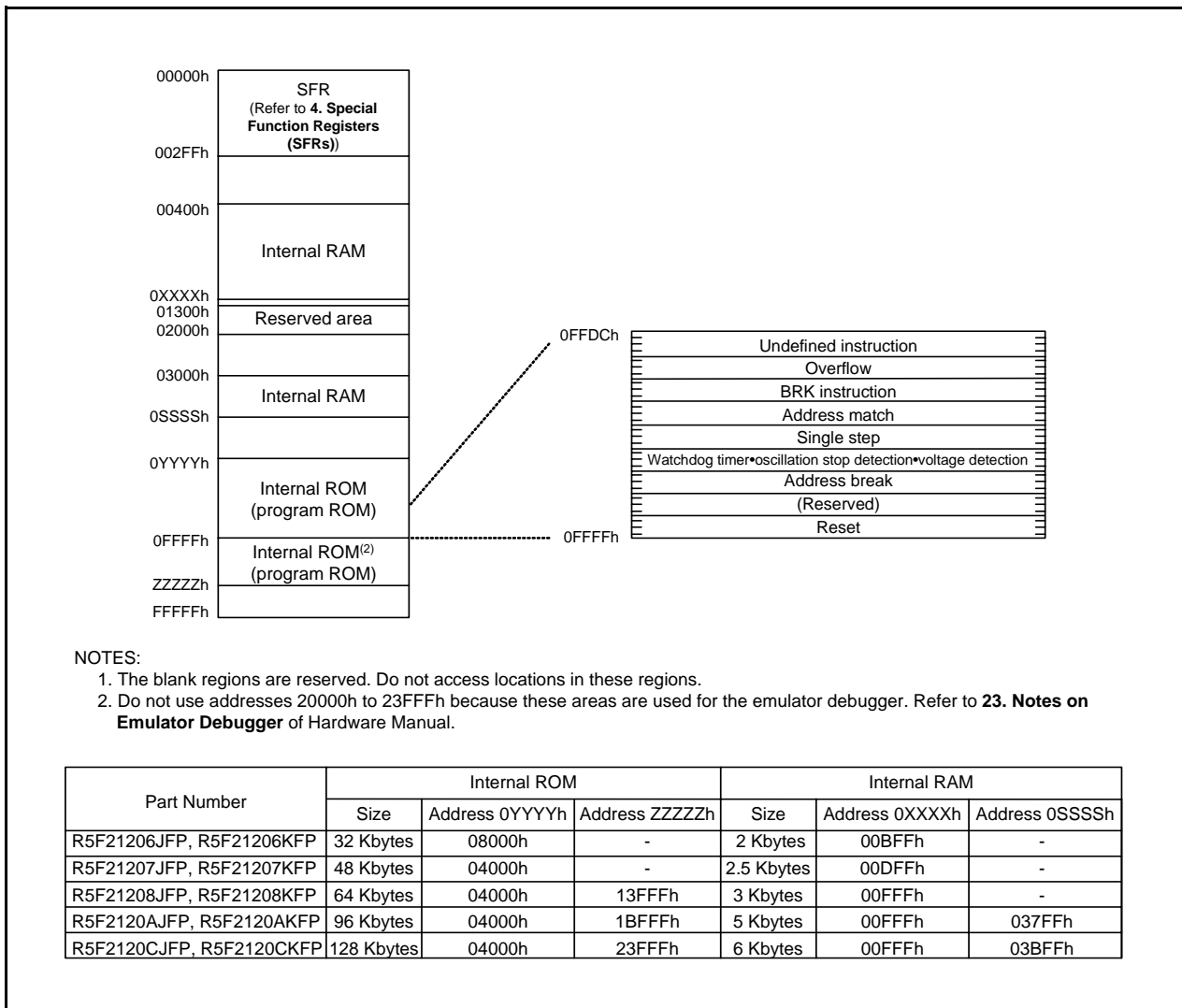

Figure 3.1 Memory Map of R8C/20 Group

### 3.2 R8C/21 Group

Figure 3.2 shows a Memory Map of R8C/21 Group. The R8C/21 Group has 1 Mbyte of address space from address 00000h to FFFFFFFh.

The internal ROM (program ROM) is allocated lower addresses, beginning with address 0FFFFh. For example, a 48-Kbyte internal ROM is allocated addresses 04000h to 0FFFFh.

The fixed interrupt vector table is allocated addresses 0FFDCh to 0FFFFh. They store the starting address of each interrupt routine.

The internal ROM (data flash) is allocated addresses 02400h to 02BFFh.

The internal RAM is allocated higher addresses, beginning with address 00400h. For example, a 2.5-Kbyte internal RAM is allocated addresses 00400h to 00DFFh. The internal RAM is used not only for storing data but also for calling subroutines and as stacks when interrupt requests are acknowledged.

Special function registers (SFR) are allocated addresses 00000h to 002FFh. The peripheral function control registers are allocated them. All addresses within the SFR, which have nothing allocated are reserved for future use and cannot be accessed by users.

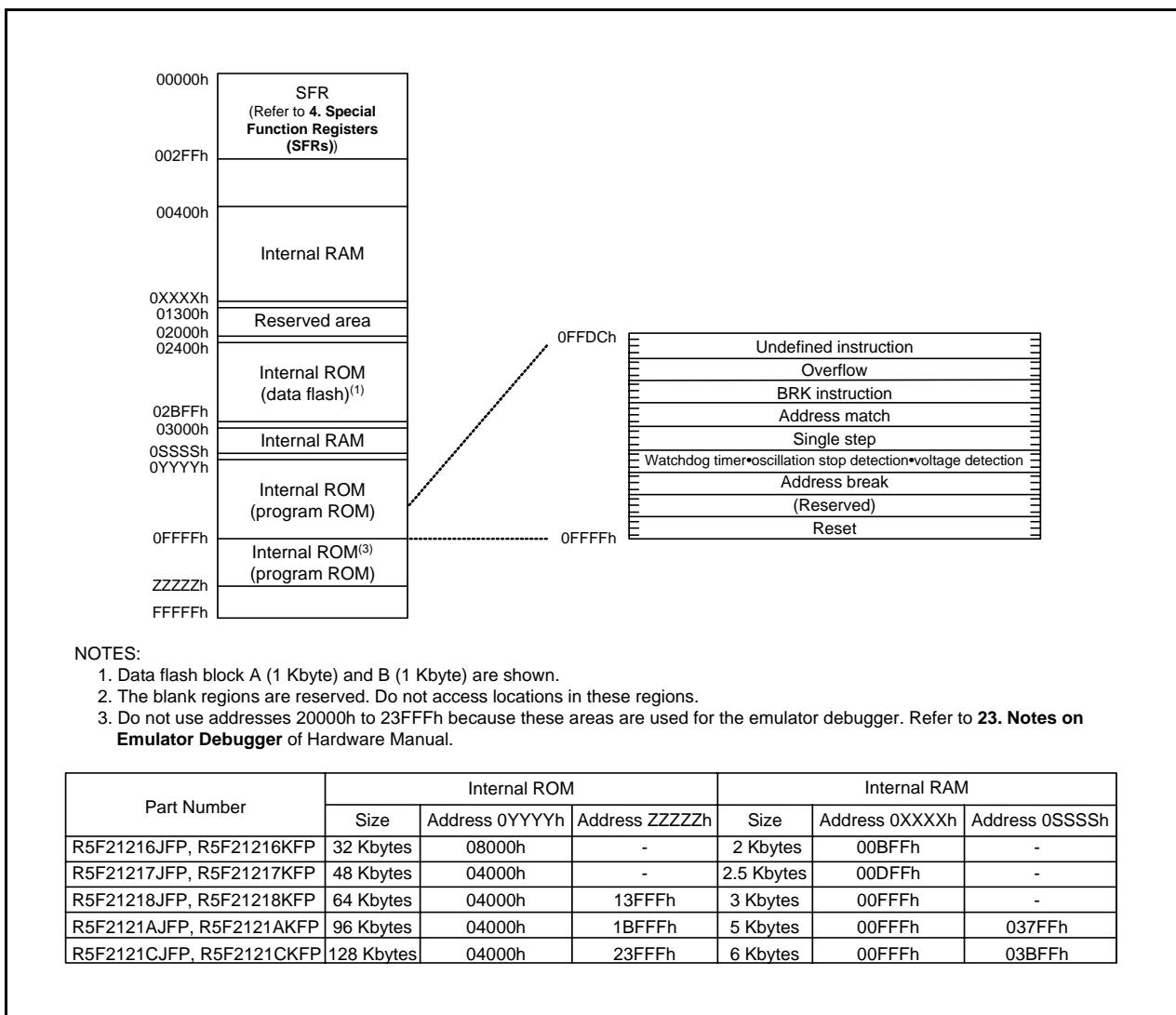

Figure 3.2 Memory Map of R8C/21 Group



## 4. Special Function Registers (SFRs)

An SFR (special function register) is a control register for a peripheral function. Table 4.1 to Table 4.6 list the SFR Information.

**Table 4.1 SFR Information (1)(1)**

| Address | Register  | Symbol | After reset  |
|---------|---|--------|--|
| 0000h   |   |        |  |
| 0001h   |   |        |  |
| 0002h   |   |        |  |
| 0003h   |   |        |  |
| 0004h   | Processor Mode Register 0                                 | PM0    | 00h  |
| 0005h   | Processor Mode Register 1                                 | PM1    | 00h  |
| 0006h   | System Clock Control Register 0                           | CM0    | 01101000b  |
| 0007h   | System Clock Control Register 1                           | CM1    | 00100000b  |
| 0008h   |   |        |  |
| 0009h   |   |        |  |
| 000Ah   | Protect Register  | PRCR   | 00h  |
| 000Bh   |   |        |  |
| 000Ch   | Oscillation Stop Detection Register                       | OCD    | 00000100b  |
| 000Dh   | Watchdog Timer Reset Register                             | WDTR   | XXh  |
| 000Eh   | Watchdog Timer Start Register                             | WDTS   | XXh  |
| 000Fh   | Watchdog Timer Control Register                           | WDC    | 00X11111b  |
| 0010h   | Address Match Interrupt Register 0                        | RMAD0  | 00h  |
| 0011h   |   |        | 00h  |
| 0012h   |   |        | 00h  |
| 0013h   | Address Match Interrupt Enable Register                   | AIER   | 00h  |
| 0014h   | Address Match Interrupt Register 1                        | RMAD1  | 00h  |
| 0015h   |   |        | 00h  |
| 0016h   |   |        | 00h  |
| 0017h   |   |        | 00h  |
| 0018h   |   |        |  |
| 0019h   |   |        |  |
| 001Ah   |   |        |  |
| 001Bh   |   |        |  |
| 001Ch   | Count Source Protect Mode Register                        | CSPR   | 00h<br>10000000b <sup>(8)</sup>                      |
| 001Dh   |   |        |  |
| 001Eh   |   |        |  |
| 001Fh   |   |        |  |
| 0020h   |   |        |  |
| 0021h   |   |        |  |
| 0022h   |   |        |  |
| 0023h   | High-Speed On-Chip Oscillator Control Register 0          | FRA0   | 00h  |
| 0024h   | High-Speed On-Chip Oscillator Control Register 1          | FRA1   | When shipping  |
| 0025h   | High-Speed On-Chip Oscillator Control Register 2          | FRA2   | 00h  |
| 0026h   |   |        |  |
| 0030h   |   |        |  |
| 0031h   | Voltage Detection Register 1 <sup>(2)</sup>               | VCA1   | 00001000b  |
| 0032h   | Voltage Detection Register 2 <sup>(6)</sup>               | VCA2   | 00h <sup>(3)</sup><br>01000000b <sup>(4)</sup>       |
| 0033h   |   |        |  |
| 0034h   |   |        |  |
| 0035h   |   |        |  |
| 0036h   | Voltage Monitor 1 Circuit Control Register <sup>(7)</sup> | VW1C   | 0000X000b <sup>(3)</sup><br>0100X001b <sup>(4)</sup> |
| 0037h   | Voltage Monitor 2 Circuit Control Register <sup>(5)</sup> | VW2C   | 00h  |
| 0038h   |   |        |  |
| 0039h   |   |        |  |
| 003Fh   |   |        |  |

X: Undefined

**NOTES:**

1. The blank regions are reserved. Do not access locations in these regions.
2. Software reset, watchdog timer reset, and voltage monitor 2 reset do not affect this register.
3. The LVD0ON bit in the OFS register is set to 1.
4. Power-on reset, voltage monitor 1 reset or the LVD0ON bit in the OFS register is set to 0.
5. Software reset, watchdog timer reset, and voltage monitor 2 reset do not affect b2 and b3.
6. Software reset, watchdog timer reset, and voltage monitor 2 reset do not affect b7.
7. Software reset, the watchdog timer reset, and the voltage monitor 2 reset do not affect other than the b0 and b6.
8. The CSPROINI bit in the OFS register is 0.

**Table 4.2 SFR Information (2)<sup>(1)</sup>**

| Address | Register   | Symbol      | After reset |
|---------|--|-------------|-------------|
| 0040h   |  |             |             |
| 0041h   |  |             |             |
| 0042h   |  |             |             |
| 0043h   |  |             |             |
| 0044h   |  |             |             |
| 0045h   |  |             |             |
| 0046h   |  |             |             |
| 0047h   |  |             |             |
| 0048h   | Timer RD0 Interrupt Control Register   | TRD0IC      | XXXXX000b   |
| 0049h   | Timer RD1 Interrupt Control Register   | TRD1IC      | XXXXX000b   |
| 004Ah   | Timer RE Interrupt Control Register  | TREIC       | XXXXX000b   |
| 004Bh   |  |             |             |
| 004Ch   |  |             |             |
| 004Dh   | Key Input Interrupt Control Register   | KUPIC       | XXXXX000b   |
| 004Eh   | A/D Conversion Interrupt Control Register  | ADIC        | XXXXX000b   |
| 004Fh   | SSU Interrupt Control Register/IIC Bus Interrupt Control Register <sup>(2)</sup> | SSUIC/IICIC | XXXXX000b   |
| 0050h   |  |             |             |
| 0051h   | UART0 Transmit Interrupt Control Register  | S0TIC       | XXXXX000b   |
| 0052h   | UART0 Receive Interrupt Control Register   | S0RIC       | XXXXX000b   |
| 0053h   | UART1 Transmit Interrupt Control Register  | S1TIC       | XXXXX000b   |
| 0054h   | UART1 Receive Interrupt Control Register   | S1RIC       | XXXXX000b   |
| 0055h   | INT2 Interrupt Control Register  | INT2IC      | XX00X000b   |
| 0056h   | Timer RA Interrupt Control Register  | TRAIC       | XXXXX000b   |
| 0057h   |  |             |             |
| 0058h   | Timer RB Interrupt Control Register  | TRBIC       | XXXXX000b   |
| 0059h   | INT1 Interrupt Control Register  | INT1IC      | XX00X000b   |
| 005Ah   | INT3 Interrupt Control Register  | INT3IC      | XX00X000b   |
| 005Bh   |  |             |             |
| 005Ch   |  |             |             |
| 005Dh   | INT0 Interrupt Control Register  | INT0IC      | XX00X000b   |
| 005Eh   |  |             |             |
| 005Fh   |  |             |             |
| 0060h   |  |             |             |
| 0061h   |  |             |             |
| 0062h   |  |             |             |
| 0063h   |  |             |             |
| 0064h   |  |             |             |
| 0065h   |  |             |             |
| 0066h   |  |             |             |
| 0067h   |  |             |             |
| 0068h   |  |             |             |
| 0069h   |  |             |             |
| 006Ah   |  |             |             |
| 006Bh   |  |             |             |
| 006Ch   |  |             |             |
| 006Dh   |  |             |             |
| 006Eh   |  |             |             |
| 006Fh   |  |             |             |
| 0070h   |  |             |             |
| 0071h   |  |             |             |
| 0072h   |  |             |             |
| 0073h   |  |             |             |
| 0074h   |  |             |             |
| 0075h   |  |             |             |
| 0076h   |  |             |             |
| 0077h   |  |             |             |
| 0078h   |  |             |             |
| 0079h   |  |             |             |
| 007Ah   |  |             |             |
| 007Bh   |  |             |             |
| 007Ch   |  |             |             |
| 007Dh   |  |             |             |
| 007Eh   |  |             |             |
| 007Fh   |  |             |             |

X: Undefined

## NOTES:

1. The blank regions are reserved. Do not access locations in these regions.
2. Selected by the IICSEL bit in the PMR register.

**Table 4.3 SFR Information (3)<sup>(1)</sup>**

| Address | Register  | Symbol       | After reset   |
|---------|---|--------------|---------------|
| 0080h   |   |              |               |
| 0081h   |   |              |               |
| 0082h   |   |              |               |
| 0083h   |   |              |               |
| 0084h   |   |              |               |
| 0085h   |   |              |               |
| 0086h   |   |              |               |
| 0087h   |   |              |               |
| 0088h   |   |              |               |
| 0089h   |   |              |               |
| 008Ah   |   |              |               |
| 008Bh   |   |              |               |
| 008Ch   |   |              |               |
| 008Dh   |   |              |               |
| 008Eh   |   |              |               |
| 008Fh   |   |              |               |
| 0090h   |   |              |               |
| 0091h   |   |              |               |
| 0092h   |   |              |               |
| 0093h   |   |              |               |
| 0094h   |   |              |               |
| 0095h   |   |              |               |
| 0096h   |   |              |               |
| 0097h   |   |              |               |
| 0098h   |   |              |               |
| 0099h   |   |              |               |
| 009Ah   |   |              |               |
| 009Bh   |   |              |               |
| 009Ch   |   |              |               |
| 009Dh   |   |              |               |
| 009Eh   |   |              |               |
| 009Fh   |   |              |               |
| 00A0h   | UART0 Transmit/Receive Mode Register                                    | U0MR         | 00h           |
| 00A1h   | UART0 Bit Rate Register   | U0BRG        | XXh           |
| 00A2h   | UART0 Transmit Buffer Register  | U0TB         | XXh           |
| 00A3h   |   |              | XXh           |
| 00A4h   | UART0 Transmit/Receive Control Register 0                               | U0C0         | 00001000b     |
| 00A5h   | UART0 Transmit/Receive Control Register 1                               | U0C1         | 00000010b     |
| 00A6h   | UART0 Receive Buffer Register   | U0RB         | XXh           |
| 00A7h   |   |              | XXh           |
| 00A8h   | UART1 Transmit/Receive Mode Register                                    | U1MR         | 00h           |
| 00A9h   | UART1 Bit Rate Register   | U1BRG        | XXh           |
| 00AAh   | UART1 Transmit Buffer Register  | U1TB         | XXh           |
| 00ABh   |   |              | XXh           |
| 00ACh   | UART1 Transmit/Receive Control Register 0                               | U1C0         | 00001000b     |
| 00ADh   | UART1 Transmit/Receive Control Register 1                               | U1C1         | 00000010b     |
| 00AEh   | UART1 Receive Buffer Register   | U1RB         | XXh           |
| 00AFh   |   |              | XXh           |
| 00B0h   |   |              |               |
| 00B1h   |   |              |               |
| 00B2h   |   |              |               |
| 00B3h   |   |              |               |
| 00B4h   |   |              |               |
| 00B5h   |   |              |               |
| 00B6h   |   |              |               |
| 00B7h   |   |              |               |
| 00B8h   | SS Control Register H/IIC Bus Control Register 1 <sup>(2)</sup>         | SSCRH/ICCR1  | 00h           |
| 00B9h   | SS Control Register L/IIC Bus Control Register 2 <sup>(2)</sup>         | SSCRL/ICCR2  | 01111101b     |
| 00BAh   | SS Mode Register/IIC Bus Mode Register 1 <sup>(2)</sup>                 | SSMR/ICMR    | 00011000b     |
| 00BBh   | SS Enable Register/IIC Bus Interrupt Enable Register <sup>(2)</sup>     | SSER/ICIER   | 00h           |
| 00BCh   | SS Status Register/IIC Bus Status Register <sup>(2)</sup>               | SSSR/ICSR    | 00h/0000X000b |
| 00BDh   | SS Mode Register 2/Slave Address Register <sup>(2)</sup>                | SSMR2/SAR    | 00h           |
| 00BEh   | SS Transmit Data Register/IIC Bus Transmit Data Register <sup>(2)</sup> | SSTDRT/ICDRT | FFh           |
| 00BFh   | SS Receive Data Register/IIC Bus Receive Data Register <sup>(2)</sup>   | SSRDR/ICDRR  | FFh           |

X: Undefined

NOTES:

1. The blank regions are reserved. Do not access locations in these regions.
2. Selected by the IICSEL bit in the PMR register.

**Table 4.4 SFR Information (4)<sup>(1)</sup>**

| Address | Register                         | Symbol | After reset |
|---------|----------------------------------|--------|-------------|
| 00C0h   | A/D Register                     | AD     | XXh         |
| 00C1h   |                                  |        | XXh         |
| 00C2h   |                                  |        |             |
| 00C3h   |                                  |        |             |
| 00C4h   |                                  |        |             |
| 00C5h   |                                  |        |             |
| 00C6h   |                                  |        |             |
| 00C7h   |                                  |        |             |
| 00C8h   |                                  |        |             |
| 00C9h   |                                  |        |             |
| 00CAh   |                                  |        |             |
| 00CBh   |                                  |        |             |
| 00CCh   |                                  |        |             |
| 00CDh   |                                  |        |             |
| 00CEh   |                                  |        |             |
| 00CFh   |                                  |        |             |
| 00D0h   |                                  |        |             |
| 00D1h   |                                  |        |             |
| 00D2h   |                                  |        |             |
| 00D3h   |                                  |        |             |
| 00D4h   | A/D Control Register 2           | ADCON2 | 00h         |
| 00D5h   |                                  |        |             |
| 00D6h   | A/D Control Register 0           | ADCON0 | 00h         |
| 00D7h   | A/D Control Register 1           | ADCON1 | 00h         |
| 00D8h   |                                  |        |             |
| 00D9h   |                                  |        |             |
| 00DAh   |                                  |        |             |
| 00DBh   |                                  |        |             |
| 00DCh   |                                  |        |             |
| 00DDh   |                                  |        |             |
| 00DEh   |                                  |        |             |
| 00DFh   |                                  |        |             |
| 00E0h   | Port P0 Register                 | P0     | XXh         |
| 00E1h   | Port P1 Register                 | P1     | XXh         |
| 00E2h   | Port P0 Direction Register       | PD0    | 00h         |
| 00E3h   | Port P1 Direction Register       | PD1    | 00h         |
| 00E4h   | Port P2 Register                 | P2     | XXh         |
| 00E5h   | Port P3 Register                 | P3     | XXh         |
| 00E6h   | Port P2 Direction Register       | PD2    | 00h         |
| 00E7h   | Port P3 Direction Register       | PD3    | 00h         |
| 00E8h   | Port P4 Register                 | P4     | XXh         |
| 00E9h   |                                  |        |             |
| 00EAh   | Port P4 Direction Register       | PD4    | 00h         |
| 00EBh   |                                  |        |             |
| 00ECh   | Port P6 Register                 | P6     | XXh         |
| 00EDh   |                                  |        |             |
| 00EEh   | Port P6 Direction Register       | PD6    | 00h         |
| 00EFh   |                                  |        |             |
| 00F0h   |                                  |        |             |
| 00F1h   |                                  |        |             |
| 00F2h   |                                  |        |             |
| 00F3h   |                                  |        |             |
| 00F4h   |                                  |        |             |
| 00F5h   | UART1 Function Select Register   | U1SR   | XXh         |
| 00F6h   |                                  |        |             |
| 00F7h   |                                  |        |             |
| 00F8h   | Port Mode Register               | PMR    | 00h         |
| 00F9h   | External Input Enable Register   | INTEN  | 00h         |
| 00FAh   | INT Input Filter Select Register | INTF   | 00h         |
| 00FBh   | Key Input Enable Register        | KIEN   | 00h         |
| 00FCh   | Pull-Up Control Register 0       | PUR0   | 00h         |
| 00FDh   | Pull-Up Control Register 1       | PUR1   | XX00XX00b   |
| 00FEh   |                                  |        |             |
| 00FFh   |                                  |        |             |

X: Undefined

NOTE:

1. The blank regions are reserved. Do not access locations in these regions.

**Table 4.5 SFR Information (5)<sup>(1)</sup>**

| Address | Register   | Symbol  | After reset |
|---------|--|---------|-------------|
| 0100h   | Timer RA Control Register                          | TRACR   | 00h         |
| 0101h   | Timer RA I/O Control Register                      | TRAIOC  | 00h         |
| 0102h   | Timer RA Mode Register                             | TRAMR   | 00h         |
| 0103h   | Timer RA Prescaler Register                        | TRAPRE  | FFh         |
| 0104h   | Timer RA Register                                  | TRA     | FFh         |
| 0105h   |  |         |             |
| 0106h   | LIN Control Register                               | LINCR   | 00h         |
| 0107h   | LIN Status Register                                | LINST   | 00h         |
| 0108h   | Timer RB Control Register                          | TRBCR   | 00h         |
| 0109h   | Timer RB One-Shot Control Register                 | TRBOCR  | 00h         |
| 010Ah   | Timer RB I/O Control Register                      | TRBIOC  | 00h         |
| 010Bh   | Timer RB Mode Register                             | TRBMR   | 00h         |
| 010Ch   | Timer RB Prescaler Register                        | TRBPRES | FFh         |
| 010Dh   | Timer RB Secondary Register                        | TRBSC   | FFh         |
| 010Eh   | Timer RB Primary                                   | TRBPR   | FFh         |
| 010Fh   |  |         |             |
| 0110h   |  |         |             |
| 0111h   |  |         |             |
| 0112h   |  |         |             |
| 0113h   |  |         |             |
| 0114h   |  |         |             |
| 0115h   |  |         |             |
| 0116h   |  |         |             |
| 0117h   |  |         |             |
| 0118h   | Timer RE Counter Data Register                     | TRESEC  | 00h         |
| 0119h   | Timer RE Compare Data Register                     | TREMIN  | 00h         |
| 011Ah   |  |         |             |
| 011Bh   |  |         |             |
| 011Ch   | Timer RE Control Register 1                        | TRECR1  | 00h         |
| 011Dh   | Timer RE Control Register 2                        | TRECR2  | 00h         |
| 011Eh   | Timer RE Count Source Select Register              | TRECSR  | 00001000b   |
| 011Fh   |  |         |             |
| 0120h   |  |         |             |
| 0121h   |  |         |             |
| 0122h   |  |         |             |
| 0123h   |  |         |             |
| 0124h   |  |         |             |
| 0125h   |  |         |             |
| 0126h   |  |         |             |
| 0127h   |  |         |             |
| 0128h   |  |         |             |
| 0129h   |  |         |             |
| 012Ah   |  |         |             |
| 012Bh   |  |         |             |
| 012Ch   |  |         |             |
| 012Dh   |  |         |             |
| 012Eh   |  |         |             |
| 012Fh   |  |         |             |
| 0130h   |  |         |             |
| 0131h   |  |         |             |
| 0132h   |  |         |             |
| 0133h   |  |         |             |
| 0134h   |  |         |             |
| 0135h   |  |         |             |
| 0136h   |  |         |             |
| 0137h   | Timer RD Start Register                            | TRDSTR  | 11111100b   |
| 0138h   | Timer RD Mode Register                             | TRDMR   | 00001110b   |
| 0139h   | Timer RD PWM Mode Register                         | TRDPMR  | 10001000b   |
| 013Ah   | Timer RD Function Control Register                 | TRDFCR  | 10000000b   |
| 013Bh   | Timer RD Output Master Enable Register 1           | TRDOER1 | FFh         |
| 013Ch   | Timer RD Output Master Enable Register 2           | TRDOER2 | 01111111b   |
| 013Dh   | Timer RD Output Control Register                   | TRDOCR  | 00h         |
| 013Eh   | Timer RD Digital Filter Function Select Register 0 | TRDDF0  | 00h         |
| 013Fh   | Timer RD Digital Filter Function Select Register 1 | TRDDF1  | 00h         |

X: Undefined

NOTE:

1. The blank regions are reserved. Do not access locations in these regions.

**Table 4.6 SFR Information (6)<sup>(1)</sup>**

| Address | Register  | Symbol   | After reset |
|---------|---|----------|-------------|
| 0140h   | Timer RD Control Register 0                       | TRDCR0   | 00h         |
| 0141h   | Timer RD I/O Control Register A0                  | TRDIORA0 | 10001000b   |
| 0142h   | Timer RD I/O Control Register C0                  | TRDIORC0 | 10001000b   |
| 0143h   | Timer RD Status Register 0                        | TRDSR0   | 11100000b   |
| 0144h   | Timer RD Interrupt Enable Register 0              | TRDIER0  | 11100000b   |
| 0145h   | Timer RD PWM Mode Output Level Control Register 0 | TRDPOCR0 | 11111000b   |
| 0146h   | Timer RD Counter 0                                | TRD0     | 00h         |
| 0147h   |   |          | 00h         |
| 0148h   | Timer RD General Register A0                      | TRDGRA0  | FFh         |
| 0149h   |   |          | FFh         |
| 014Ah   | Timer RD General Register B0                      | TRDGRB0  | FFh         |
| 014Bh   |   |          | FFh         |
| 014Ch   | Timer RD General Register C0                      | TRDGRC0  | FFh         |
| 014Dh   |   |          | FFh         |
| 014Eh   | Timer RD General Register D0                      | TRDGRD0  | FFh         |
| 014Fh   |   |          | FFh         |
| 0150h   | Timer RD Control Register 1                       | TRDCR1   | 00h         |
| 0151h   | Timer RD I/O Control Register A1                  | TRDIORA1 | 10001000b   |
| 0152h   | Timer RD I/O Control Register C1                  | TRDIORC1 | 10001000b   |
| 0153h   | Timer RD Status Register 1                        | TRDSR1   | 11000000b   |
| 0154h   | Timer RD Interrupt Enable Register 1              | TRDIER1  | 11100000b   |
| 0155h   | Timer RD PWM Mode Output Level Control Register 1 | TRDPOCR1 | 11111000b   |
| 0156h   | Timer RD Counter 1                                | TRD1     | 00h         |
| 0157h   |   |          | 00h         |
| 0158h   | Timer RD General Register A1                      | TRDGRA1  | FFh         |
| 0159h   |   |          | FFh         |
| 015Ah   | Timer RD General Register B1                      | TRDGRB1  | FFh         |
| 015Bh   |   |          | FFh         |
| 015Ch   | Timer RD General Register C1                      | TRDGRC1  | FFh         |
| 015Dh   |   |          | FFh         |
| 015Eh   | Timer RD General Register D1                      | TRDGRD1  | FFh         |
| 015Fh   |   |          | FFh         |
| 01B0h   |   |          |             |
| 01B1h   |   |          |             |
| 01B2h   |   |          |             |
| 01B3h   | Flash Memory Control Register 4                   | FMR4     | 01000000b   |
| 01B4h   |   |          |             |
| 01B5h   | Flash Memory Control Register 1                   | FMR1     | 1000000Xb   |
| 01B6h   |   |          |             |
| 01B7h   | Flash Memory Control Register 0                   | FMR0     | 00000001b   |
| 01B8h   |   |          |             |
| 01B9h   |   |          |             |
| 01BAh   |   |          |             |
| 01BBh   |   |          |             |
| 01BCh   |   |          |             |
| 01BDh   |   |          |             |
| 01BEh   |   |          |             |
| 01BFh   |   |          |             |
| FFFFh   | Option Function Select Register                   | OFS      | (Note 2)    |

X: Undefined

NOTES:

1. The blank regions are reserved. Do not access locations in these regions.
2. The OFS register cannot be changed by a program. Use a flash programmer to write to it.

## 5. Electrical Characteristics

**Table 5.1 Absolute Maximum Ratings**

| Symbol                            | Parameter                     | Condition           | Rated value                                       | Unit |
|-----------------------------------|-------------------------------|---------------------|---|------|
| V <sub>CC</sub> /AV <sub>CC</sub> | Supply voltage                |                     | -0.3 to 6.5                                       | V    |
| V <sub>I</sub>                    | Input voltage                 |                     | -0.3 to V <sub>CC</sub> +0.3                      | V    |
| V <sub>O</sub>                    | Output voltage                |                     | -0.3 to V <sub>CC</sub> +0.3                      | V    |
| P <sub>d</sub>                    | Power dissipation             | -40°C ≤ Topr ≤ 85°C | 300   | mW   |
|                                   |                               | 85°C < Topr ≤ 125°C | 125   | mW   |
| Topr                              | Operating ambient temperature |                     | -40 to 85 (J version) /<br>-40 to 125 (K version) | °C   |
| T <sub>stg</sub>                  | Storage temperature           |                     | -65 to 150  | °C   |

**Table 5.2 Recommended Operating Conditions**

| Symbol                            | Parameter                             |  | Conditions   | Standard           |      |                    | Unit |     |
|-----------------------------------|---------------------------------------|--|--|--------------------|------|--------------------|------|-----|
|                                   |                                       |  |  | Min.               | Typ. | Max.               |      |     |
| V <sub>CC</sub> /AV <sub>CC</sub> | Supply voltage                        |  |  | 2.7                | –    | 5.5                | V    |     |
| V <sub>SS</sub> /AV <sub>CC</sub> | Supply voltage                        |  |  | –                  | 0    | –                  | V    |     |
| V <sub>IH</sub>                   | Input “H” voltage                     |  |  | 0.8V <sub>CC</sub> | –    | V <sub>CC</sub>    | V    |     |
| V <sub>IL</sub>                   | Input “L” voltage                     |  |  | 0                  | –    | 0.2V <sub>CC</sub> | V    |     |
| I <sub>OH(sum)</sub>              | Peak sum output “H” current           | Sum of all Pins I <sub>OH</sub> (peak)                 |  | –                  | –    | -60                | mA   |     |
| I <sub>OH(peak)</sub>             | Peak output “H” current               |  |  | –                  | –    | -10                | mA   |     |
| I <sub>OH(ave)</sub>              | Average output “H” current            |  |  | –                  | –    | -5                 | mA   |     |
| I <sub>OL(sum)</sub>              | Peak sum output “L” currents          | Sum of all Pins I <sub>OL</sub> (peak)                 |  | –                  | –    | 60                 | mA   |     |
| I <sub>OL(peak)</sub>             | Peak output “L” currents              |  |  | –                  | –    | 10                 | mA   |     |
| I <sub>OL(ave)</sub>              | Average output “L” current            |  |  | –                  | –    | 5                  | mA   |     |
| f <sub>(XIN)</sub>                | XIN clock input oscillation frequency |  | 3.0 V ≤ V <sub>CC</sub> ≤ 5.5 V<br>-40°C ≤ Topr ≤ 85°C   | 0                  | –    | 20                 | MHz  |     |
|                                   |                                       |  | 3.0 V ≤ V <sub>CC</sub> ≤ 5.5 V<br>-40°C ≤ Topr ≤ 125°C  | 0                  | –    | 16                 | MHz  |     |
|                                   |                                       |  | 2.7 V ≤ V <sub>CC</sub> < 3.0 V  | 0                  | –    | 10                 | MHz  |     |
| –                                 | System clock                          | OCD2 = 0<br>When XIN clock is selected.                | 3.0 V ≤ V <sub>CC</sub> ≤ 5.5 V<br>-40°C ≤ Topr ≤ 85°C   | 0                  | –    | 20                 | MHz  |     |
|                                   |                                       |  | 3.0 V ≤ V <sub>CC</sub> ≤ 5.5 V<br>-40°C ≤ Topr ≤ 125°C  | 0                  | –    | 16                 | MHz  |     |
|                                   |                                       |  | 2.7 V ≤ V <sub>CC</sub> < 3.0 V  | 0                  | –    | 10                 | MHz  |     |
|                                   |                                       | OCD2 = 1<br>When on-chip oscillator clock is selected. | FRA01 = 0<br>When low-speed on-chip oscillator clock is selected.  | –                  | 125  | –                  | –    | kHz |
|                                   |                                       |  | FRA01 = 1<br>When high-speed on-chip oscillator clock is selected.<br>3.0 V ≤ V <sub>CC</sub> ≤ 5.5 V<br>-40°C ≤ Topr ≤ 85°C | –                  | –    | –                  | 20   | MHz |
|                                   |                                       |  | FRA01 = 1<br>When high-speed on-chip oscillator clock is selected.   | –                  | –    | –                  | 10   | MHz |

**NOTES:**

- V<sub>CC</sub> = 2.7 to 5.5 V at Topr = -40 to 85°C (J version) / -40 to 125°C (K version), unless otherwise specified.
- The average output current indicates the average value of current measured during 100 ms.

**Table 5.3 A/D Converter Characteristics**

| Symbol       | Parameter                           |                       | Conditions  | Standard |      |           | Unit          |
|--------------|-------------------------------------|-----------------------|---|----------|------|-----------|---------------|
|              |                                     |                       |   | Min.     | Typ. | Max.      |               |
| –            | Resolution                          |                       | $V_{ref} = AV_{CC}$   | –        | –    | 10        | Bits          |
| –            | Absolute Accuracy                   | 10-bit mode           | $\phi_{AD} = 10 \text{ MHz}, V_{ref} = AV_{CC} = 5.0 \text{ V}$ | –        | –    | $\pm 3$   | LSB           |
|              |                                     | 8-bit mode            | $\phi_{AD} = 10 \text{ MHz}, V_{ref} = AV_{CC} = 5.0 \text{ V}$ | –        | –    | $\pm 2$   | LSB           |
|              |                                     | 10-bit mode           | $\phi_{AD} = 10 \text{ MHz}, V_{ref} = AV_{CC} = 3.3 \text{ V}$ | –        | –    | $\pm 5$   | LSB           |
|              |                                     | 8-bit mode            | $\phi_{AD} = 10 \text{ MHz}, V_{ref} = AV_{CC} = 3.3 \text{ V}$ | –        | –    | $\pm 2$   | LSB           |
| $R_{ladder}$ | Resistor ladder                     |                       | $V_{ref} = AV_{CC}$   | 10       | –    | 40        | $k\Omega$     |
| $t_{conv}$   | Conversion time                     | 10-bit mode           | $\phi_{AD} = 10 \text{ MHz}, V_{ref} = AV_{CC} = 5.0 \text{ V}$ | 3.3      | –    | –         | $\mu\text{s}$ |
|              |                                     | 8-bit mode            | $\phi_{AD} = 10 \text{ MHz}, V_{ref} = AV_{CC} = 5.0 \text{ V}$ | 2.8      | –    | –         | $\mu\text{s}$ |
| $V_{ref}$    | Reference voltage                   |                       |   | 2.7      | –    | $AV_{CC}$ | V             |
| $V_{IA}$     | Analog input voltage <sup>(2)</sup> |                       |   | 0        | –    | $AV_{CC}$ | V             |
| –            | A/D operating clock frequency       | Without sample & hold |   | 0.25     | –    | 10        | MHz           |
|              |                                     | With sample & hold    |   | 1        | –    | 10        | MHz           |

## NOTES:

- $V_{CC} = AV_{CC} = 2.7$  to  $5.5 \text{ V}$  at  $T_{opr} = -40$  to  $85^\circ\text{C}$  (J version) /  $-40$  to  $125^\circ\text{C}$  (K version), unless otherwise specified.
- When analog input voltage exceeds reference voltage, A/D conversion result is 3FFh in 10-bit mode, FFh in 8-bit mode.

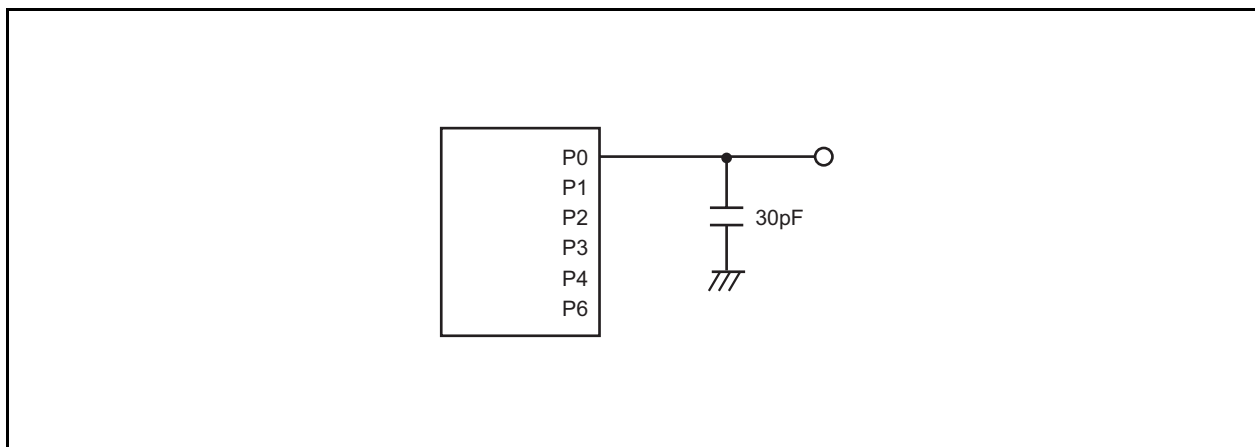
**Figure 5.1 Ports P0 to P4, P6 Timing Measurement Circuit**



**Table 5.4 Flash Memory (Program ROM) Electrical Characteristics**

| Symbol                  | Parameter   | Conditions                 | Standard             |      |                             | Unit  |
|-------------------------|---|----------------------------|----------------------|------|-----------------------------|-------|
|                         |   |                            | Min.                 | Typ. | Max.                        |       |
| –                       | Program/erase endurance <sup>(2)</sup>                              | R8C/20 Group               | 100 <sup>(3)</sup>   | –    | –                           | times |
|                         |   | R8C/21 Group               | 1,000 <sup>(3)</sup> | –    | –                           | times |
| –                       | Byte program time   |                            | –                    | 50   | 400                         | μs    |
| –                       | Block erase time  |                            | –                    | 0.4  | 9                           | s     |
| t <sub>d</sub> (SR-SUS) | Time delay from suspend request until erase suspend                 |                            | –                    | –    | 97 + CPU clock<br>× 6 cycle | μs    |
| –                       | Interval from erase start/restart until following suspend request   |                            | 650                  | –    | –                           | μs    |
| –                       | Interval from program start/restart until following suspend request |                            | 0                    | –    | –                           | ns    |
| –                       | Time from suspend until program/erase restart                       |                            | –                    | –    | 3 + CPU clock<br>× 4 cycle  | μs    |
| –                       | Program, erase voltage  |                            | 2.7                  | –    | 5.5                         | V     |
| –                       | Read voltage  |                            | 2.7                  | –    | 5.5                         | V     |
| –                       | Program, erase temperature  |                            | 0                    | –    | 60                          | °C    |
| –                       | Data hold time <sup>(7)</sup>                                       | Ambient temperature = 55°C | 20                   | –    | –                           | year  |

## NOTES:

- V<sub>CC</sub> = 2.7 to 5.5 V at Topr = -40 to 85°C (J version) / -40 to 125°C (K version), unless otherwise specified.
- Definition of programming/erasure endurance  
The programming and erasure endurance is defined on a per-block basis.  
If the programming and erasure endurance is n (n = 100 or 1,000), each block can be erased n times.  
For example, if 1,024 1-byte writes are performed to different addresses in block A, a 1 Kbyte block, and then the block is erased, the programming/erasure endurance still stands at one. However, the same address must not be programmed more than once per erase operation (overwriting prohibited).
- Endurance to guarantee all electrical characteristics after program and erase (1 to Min. value can be guaranteed).
- In a system that executes multiple programming operations, the actual erasure endurance can be reduced by writing to sequential addresses in turn so that as much of the block as possible is used up before performing an erase operation. For example, when programming groups of 16 bytes, the effective number of rewrites can be minimized by programming up to 128 groups before erasing them all in one operation. It is also advisable to retain data on the erasure endurance of each block and limit the number of erase operations to a certain number.
- If error occurs during block erase, attempt to execute the clear status register command, then the block erase command at least three times until the erase error does not occur.
- Customers desiring program/erase failure rate information should contact their Renesas technical support representative.
- The data hold time includes time that the power supply is off or the clock is not supplied.

**Table 5.5 Flash Memory (Data Flash Block A, Block B) Electrical Characteristics<sup>(4)</sup>**

| Symbol     | Parameter   | Conditions                 | Standard              |      |                             | Unit  |
|------------|---|----------------------------|-----------------------|------|-----------------------------|-------|
|            |   |                            | Min.                  | Typ. | Max.                        |       |
| –          | Program/erase endurance <sup>(2)</sup>                              |                            | 10,000 <sup>(3)</sup> | –    | –                           | times |
| –          | Byte program time<br>(Program/erase endurance ≤ 1,000 times)        |                            | –                     | 50   | 400                         | μs    |
| –          | Byte program time<br>(Program/erase endurance > 1,000 times)        |                            | –                     | 65   | –                           | μs    |
| –          | Block erase time<br>(Program/erase endurance ≤ 1,000 times)         |                            | –                     | 0.2  | 9                           | s     |
| –          | Block erase time<br>(Program/erase endurance > 1,000 times)         |                            | –                     | 0.3  | –                           | s     |
| td(SR-SUS) | Time delay from suspend request until erase suspend                 |                            | –                     | –    | 97 + CPU clock<br>× 6 cycle | μs    |
| –          | Interval from erase start/restart until following suspend request   |                            | 650                   | –    | –                           | μs    |
| –          | Interval from program start/restart until following suspend request |                            | 0                     | –    | –                           | ns    |
| –          | Time from suspend until program/erase restart                       |                            | –                     | –    | 3 + CPU clock<br>× 4 cycle  | μs    |
| –          | Program, erase voltage  |                            | 2.7                   | –    | 5.5                         | V     |
| –          | Read voltage  |                            | 2.7                   | –    | 5.5                         | V     |
| –          | Program, erase temperature  |                            | -40                   | –    | 85 <sup>(8)</sup>           | °C    |
| –          | Data hold time <sup>(9)</sup>                                       | Ambient temperature = 55°C | 20                    | –    | –                           | year  |

## NOTES:

1. Vcc = 2.7 to 5.5 V at Topr = -40 to 85°C (J version) / -40 to 125°C (K version), unless otherwise specified.
2. Definition of programming/erasure endurance  
The programming and erasure endurance is defined on a per-block basis.  
If the programming and erasure endurance is n (n = 10,000), each block can be erased n times.  
For example, if 1,024 1-byte writes are performed to different addresses in block A, a 1 Kbyte block, and then the block is erased, the programming/erasure endurance still stands at one. However, the same address must not be programmed more than once per erase operation (overwriting prohibited).
3. Minimum endurance to guarantee all electrical characteristics after program and erase (1 to Min. value can be guaranteed).
4. Standard of block A and block B when program and erase endurance exceeds 1,000 times. Byte program time to 1,000 times are the same as that in program ROM.
5. In a system that executes multiple programming operations, the actual erasure endurance can be reduced by writing to sequential addresses in turn so that as much of the block as possible is used up before performing an erase operation. For example, when programming groups of 16 bytes, the effective number of rewrites can be minimized by programming up to 128 groups before erasing them all in one operation. In addition, averaging the erasure endurance between blocks A and B can further reduce the actual erasure endurance. It is also advisable to retain data on the erasure endurance of each block and limit the number of erase operations to a certain number.
6. If error occurs during block erase, attempt to execute the clear status register command, then the block erase command at least three times until the erase error does not occur.
7. Customers desiring program/erase failure rate information should contact their Renesas technical support representative.
8. 125°C for K version.
9. The data hold time includes time that the power supply is off or the clock is not supplied.

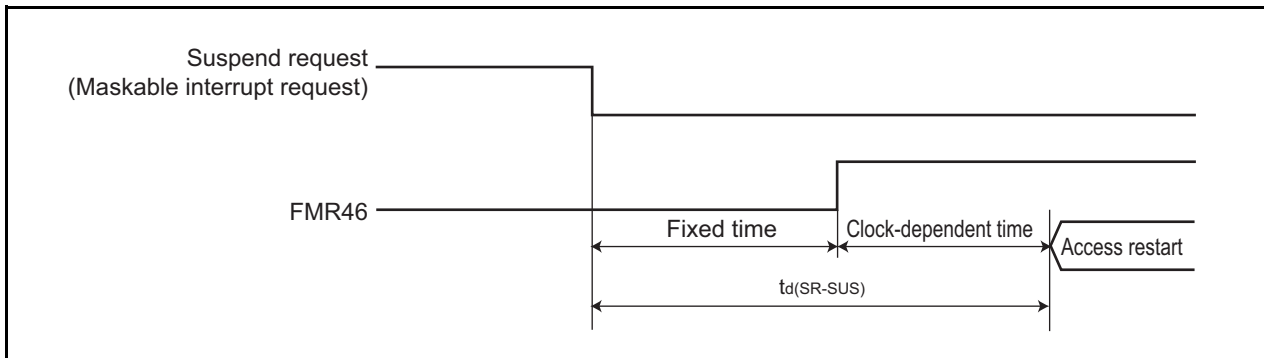

Figure 5.2 Time delay until Suspend

Table 5.6 Voltage Detection 1 Circuit Electrical Characteristics

| Symbol                                | Parameter  | Condition                          | Standard |      |      | Unit |
|---------------------------------------|--|------------------------------------|----------|------|------|------|
|                                       |  |                                    | Min.     | Typ. | Max. |      |
| V <sub>det1</sub>                     | Voltage detection level <sup>(3, 4)</sup>                                    |                                    | 2.70     | 2.85 | 3.00 | V    |
| t <sub>d</sub> (V <sub>det1</sub> -A) | Voltage monitor 1 reset generation time <sup>(5)</sup>                       |                                    | –        | 40   | 200  | μs   |
| –                                     | Voltage detection circuit self power consumption                             | VCA26 = 1, V <sub>CC</sub> = 5.0 V | –        | 0.6  | –    | μA   |
| t <sub>d</sub> (E-A)                  | Waiting time until voltage detection circuit operation starts <sup>(2)</sup> |                                    | –        | –    | 100  | μs   |
| V <sub>ccmin</sub>                    | MCU operating voltage minimum value  |                                    | 2.70     | –    | –    | V    |

## NOTES:

1. The measurement condition is V<sub>CC</sub> = 2.7 V to 5.5 V and Topr = -40°C to 85°C (J version) / -40°C to 125°C (K version).
2. Necessary time until the voltage detection circuit operates when setting to 1 again after setting the VCA26 bit in the VCA2 register to 0.
3. Hold V<sub>det2</sub> > V<sub>det1</sub>.
4. This parameter shows the voltage detection level when the power supply drops. The voltage detection level when the power supply rises is higher than the voltage detection level when the power supply drops by approximately 0.1 V.
5. Time until the voltage monitor 1 reset is generated after the voltage passes V<sub>det1</sub> when V<sub>CC</sub> falls. When using the digital filter, its sampling time is added to t<sub>d</sub>(V<sub>det1</sub>-A). When using the voltage monitor 1 reset, maintain this time until V<sub>CC</sub> = 2.0 V after the voltage passes V<sub>det1</sub> when the power supply falls.

Table 5.7 Voltage Detection 2 Circuit Electrical Characteristics

| Symbol                                | Parameter  | Condition                         | Standard |      |      | Unit |
|---------------------------------------|--|-----------------------------------|----------|------|------|------|
|                                       |  |                                   | Min.     | Typ. | Max. |      |
| V <sub>det2</sub>                     | Voltage detection level <sup>(4)</sup>                                       |                                   | 3.3      | 3.6  | 3.9  | V    |
| t <sub>d</sub> (V <sub>det2</sub> -A) | Voltage monitor 2 reset/interrupt request generation time <sup>(2, 5)</sup>  |                                   | –        | 40   | 200  | μs   |
| –                                     | Voltage detection circuit self power consumption                             | VCA27 = 1, V <sub>CC</sub> = 5.0V | –        | 0.6  | –    | μA   |
| t <sub>d</sub> (E-A)                  | Waiting time until voltage detection circuit operation starts <sup>(3)</sup> |                                   | –        | –    | 100  | μs   |

## NOTES:

1. The measurement condition is V<sub>CC</sub> = 2.7 V to 5.5 V and Topr = -40°C to 85°C (J version) / -40°C to 125°C (K version).
2. Time until the voltage monitor 2 reset/interrupt request is generated since the voltage passes V<sub>det2</sub>.
3. Necessary time until the voltage detection circuit operates when setting to 1 again after setting the VCA27 bit in the VCA2 register to 0.
4. Hold V<sub>det2</sub> > V<sub>det1</sub>.
5. When using the digital filter, its sampling time is added to t<sub>d</sub>(V<sub>det2</sub>-A). When using the voltage monitor 2 reset, maintain this time until V<sub>CC</sub> = 2.0 V after the voltage passes V<sub>det2</sub> when the power supply falls.

**Table 5.8 Power-on Reset Circuit, Voltage Monitor 1 Reset Circuit Electrical Characteristics<sup>(3)</sup>**

| Symbol            | Parameter   | Condition               | Standard          |      |                   | Unit    |
|-------------------|---|-------------------------|-------------------|------|-------------------|---------|
|                   |   |                         | Min.              | Typ. | Max.              |         |
| V <sub>por1</sub> | Power-on reset valid voltage <sup>(4)</sup>       |                         | –                 | –    | 0.1               | V       |
| V <sub>por2</sub> | Power-on reset or voltage monitor 1 valid voltage |                         | 0                 | –    | V <sub>det1</sub> | V       |
| tr <sub>th</sub>  | External power V <sub>CC</sub> rise gradient      | V <sub>CC</sub> ≤ 3.6 V | 20 <sup>(2)</sup> | –    | –                 | mV/msec |
|                   |   | V <sub>CC</sub> > 3.6 V | 20 <sup>(2)</sup> | –    | 2,000             | mV/msec |

NOTES:

1. Topr = -40°C to 85°C (J version) / -40°C to 125°C (K version), unless otherwise specified.
2. This condition (the minimum value of external power V<sub>CC</sub> rise gradient) does not apply if V<sub>por2</sub> ≥ 1.0 V.
3. To use the power-on reset function, enable voltage monitor 1 reset by setting the LVD1ON bit in the OFS register to 0, the VW1C0 and VW1C6 bits in the VW1C register to 1 respectively, and the VCA26 bit in the VCA2 register to 1.
4. tw<sub>(por1)</sub> indicates the duration the external power V<sub>CC</sub> must be held below the effective voltage (V<sub>por1</sub>) to enable a power on reset. When turning on the power for the first time, maintain tw<sub>(por1)</sub> for 30s or more if -20°C ≤ Topr ≤ 125°C, maintain tw<sub>(por1)</sub> for 3,000s or more if -40°C ≤ Topr < -20°C.

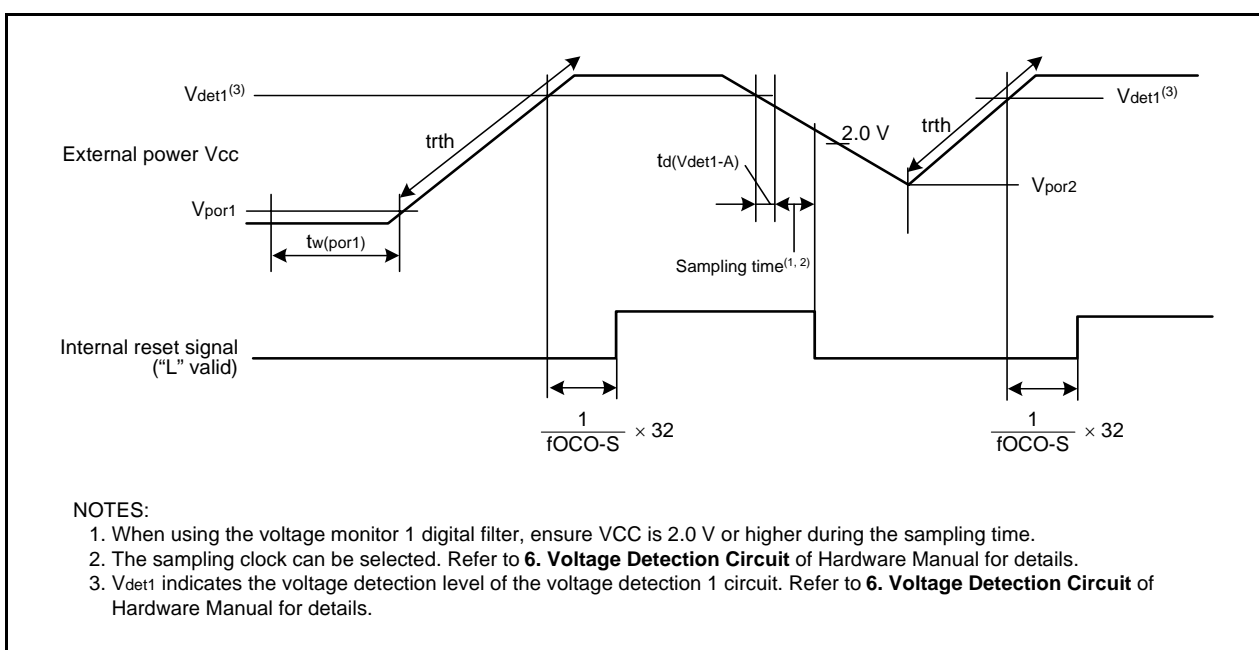

**Figure 5.3 Power-on Reset Circuit Electrical Characteristics**

**Table 5.9 High-Speed On-Chip Oscillator Circuit Electrical Characteristics**

| Symbol  | Parameter  | Condition   | Standard |       |      | Unit |
|---------|--|---|----------|-------|------|------|
|         |  |   | Min.     | Typ.  | Max. |      |
| fOCO40M | High-speed on-chip oscillator frequency temperature<br>• supply voltage dependence | V <sub>CC</sub> = 4.75 V to 5.25 V,<br>0°C ≤ Topr ≤ 60°C <sup>(2)</sup>     | 39.2     | 40    | 40.8 | MHz  |
|         |  | V <sub>CC</sub> = 3.0 V to 5.25 V,<br>-20°C ≤ Topr ≤ 85°C <sup>(2)</sup>    | 38.8     | 40    | 41.2 | MHz  |
|         |  | V <sub>CC</sub> = 3.0 V to 5.5 V,<br>-40°C ≤ Topr ≤ 85°C <sup>(2)</sup>     | 38.4     | 40    | 41.6 | MHz  |
|         |  | V <sub>CC</sub> = 3.0 V to 5.5 V,<br>-40°C ≤ Topr ≤ 125°C <sup>(2)</sup>    | 38.0     | 40    | 42.0 | MHz  |
|         |  | V <sub>CC</sub> = 2.7 V to 5.5 V,<br>-40°C ≤ Topr ≤ 125°C <sup>(2)</sup>    | 37.6     | 40    | 42.4 | MHz  |
| –       | The value of the FRA1 register when the reset is deasserted                        |   | 08h      | 40    | F7h  | –    |
| –       | High-speed on-chip oscillator adjustment range                                     | Adjust the FRA1 register to -1 bit (the value when the reset is deasserted) | –        | + 0.3 | –    | MHz  |
| –       | Oscillation stability time   |   | –        | 10    | 100  | μs   |
| –       | Self power consumption when high-speed on-chip oscillator oscillating              | V <sub>CC</sub> = 5.0 V, Topr = 25°C  | –        | 600   | –    | μA   |

## NOTES:

- V<sub>CC</sub> = 2.7 V to 5.5 V, Topr = -40°C to 85°C (J version) / -40°C to 125°C (K version), unless otherwise specified.
- The standard value shows when the reset is deasserted for the FRA1 register.

**Table 5.10 Low-Speed On-Chip Oscillator Circuit Electrical Characteristics**

| Symbol | Parameter  | Condition                            | Standard |      |      | Unit |
|--------|--|--------------------------------------|----------|------|------|------|
|        |  |                                      | Min.     | Typ. | Max. |      |
| fOCO-S | Low-speed on-chip oscillator frequency                               |                                      | 40       | 125  | 250  | kHz  |
| –      | Oscillation stability time   |                                      | –        | 10   | 100  | μs   |
| –      | Self power consumption when low-speed on-chip oscillator oscillating | V <sub>CC</sub> = 5.0 V, Topr = 25°C | –        | 15   | –    | μA   |

## NOTE:

- V<sub>CC</sub> = 2.7 V to 5.5 V, Topr = -40°C to 85°C (J version) / -40°C to 125°C (K version), unless otherwise specified.

**Table 5.11 Power Supply Circuit Timing Characteristics**

| Symbol               | Parameter   | Condition | Standard |      |      | Unit |
|----------------------|---|-----------|----------|------|------|------|
|                      |   |           | Min.     | Typ. | Max. |      |
| t <sub>d</sub> (P-R) | Time for internal power supply stabilization during power-on <sup>(2)</sup> |           | 1        | –    | 2000 | μs   |
| t <sub>d</sub> (R-S) | STOP exit time <sup>(3)</sup>   |           | –        | –    | 150  | μs   |

## NOTES:

- The measurement condition is V<sub>CC</sub> = 2.7 to 5.5 V and Topr = -40°C to 85°C (J version) / -40°C to 125°C (K version), unless otherwise specified.
- Waiting time until the internal power supply generation circuit stabilizes during power-on.
- Time until CPU clock supply starts since the interrupt is acknowledged to exit stop mode.

**Table 5.12 Timing Requirements of Clock Synchronous Serial I/O with Chip Select<sup>(1)</sup>**

| Symbol | Parameter                          | Conditions | Standard   |      |             | Unit                |
|--------|------------------------------------|------------|------------|------|-------------|---------------------|
|        |                                    |            | Min.       | Typ. | Max.        |                     |
| tsUCYC | SSCK clock cycle time              |            | 4          | –    | –           | tcyc <sup>(2)</sup> |
| tHI    | SSCK clock "H" width               |            | 0.4        | –    | 0.6         | tsucyc              |
| tLO    | SSCK clock "L" width               |            | 0.4        | –    | 0.6         | tsucyc              |
| tRISE  | SSCK clock rising time             | Master     | –          | –    | 1           | tcyc <sup>(2)</sup> |
|        |                                    | Slave      | –          | –    | 1           | μs                  |
| tFALL  | SSCK clock falling time            | Master     | –          | –    | 1           | tcyc <sup>(2)</sup> |
|        |                                    | Slave      | –          | –    | 1           | μs                  |
| tsu    | SSO, SSI data input setup time     |            | 100        | –    | –           | ns                  |
| tH     | SSO, SSI data input hold time      |            | 1          | –    | –           | tcyc <sup>(2)</sup> |
| tLEAD  | $\overline{\text{SCS}}$ setup time | Slave      | 1tcyc + 50 | –    | –           | ns                  |
| tLAG   | $\overline{\text{SCS}}$ hold time  | Slave      | 1tcyc + 50 | –    | –           | ns                  |
| tOD    | SSO, SSI data output delay time    |            | –          | –    | 1           | tcyc <sup>(2)</sup> |
| tSA    | SSI slave access time              |            | –          | –    | 1tcyc + 100 | ns                  |
| tOR    | SSI slave out open time            |            | –          | –    | 1tcyc + 100 | ns                  |

## NOTES:

1. Vcc = 2.7 to 5.5 V, Vss = 0 V at Topr = -40 to 85°C (J version) / -40 to 125°C (K version), unless otherwise specified.
2. 1tcyc = 1/f1(s)

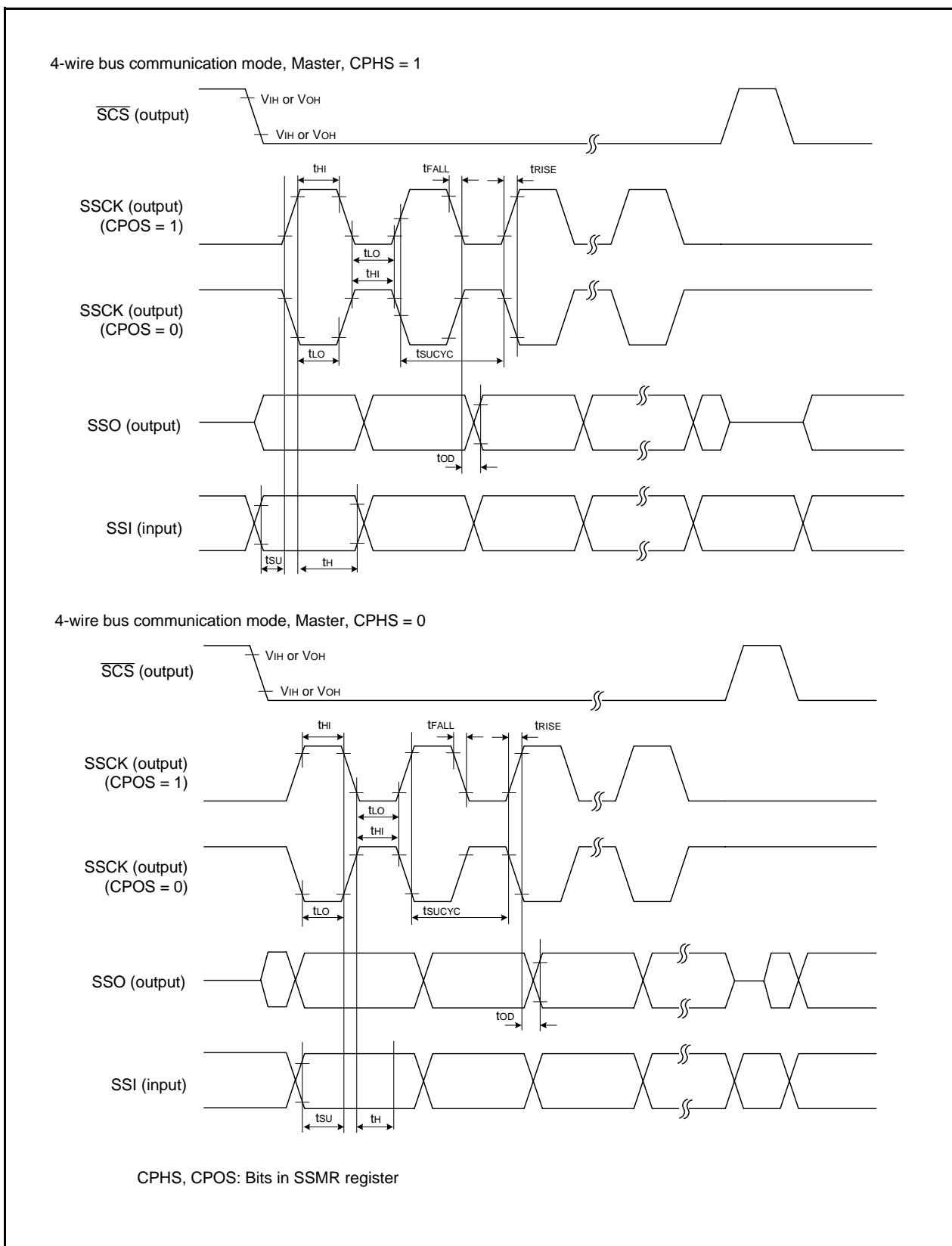

Figure 5.4 I/O Timing of Clock Synchronous Serial I/O with Chip Select (Master)

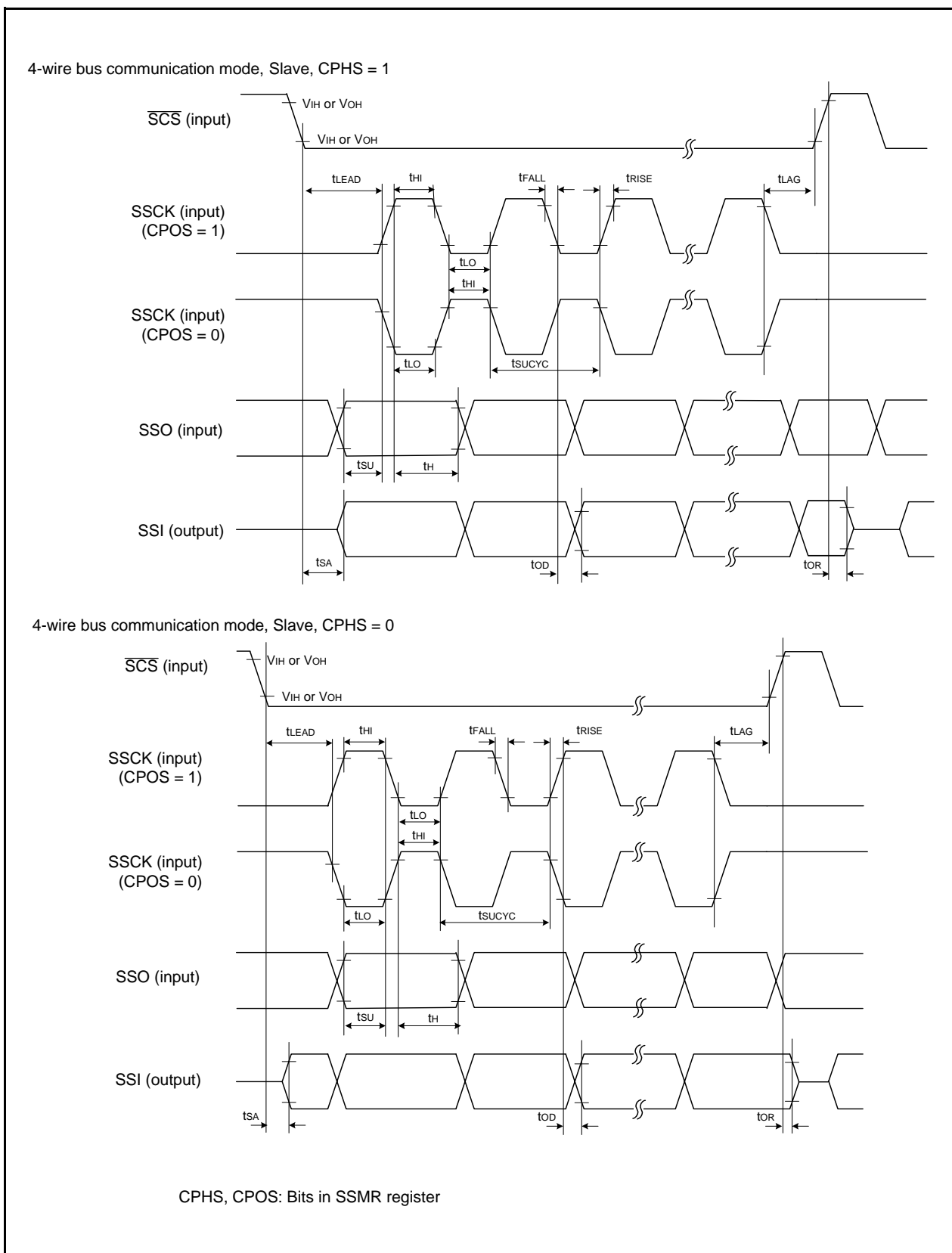
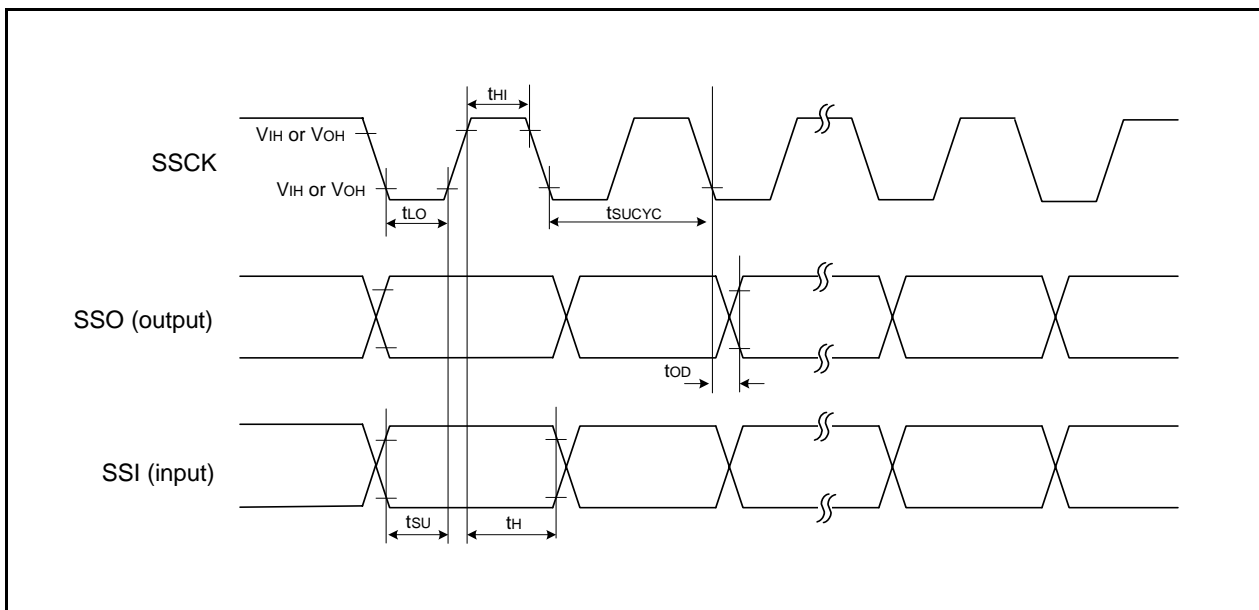

Figure 5.5 I/O Timing of Clock Synchronous Serial I/O with Chip Select (Slave)





**Figure 5.6 I/O Timing of Clock Synchronous Serial I/O with Chip Select (Clock Synchronous Communication Mode)**

**Table 5.13 Timing Requirements of I<sup>2</sup>C Bus Interface(1)**

| Symbol            | Parameter                                   | Conditions | Standard                                |      |                                  | Unit |
|-------------------|---|------------|---|------|----------------------------------|------|
|                   |   |            | Min.                                    | Typ. | Max.                             |      |
| t <sub>SCL</sub>  | SCL input cycle time                        |            | 12t <sub>CYC</sub> + 600 <sup>(2)</sup> | –    | –                                | ns   |
| t <sub>SCLH</sub> | SCL input “H” width                         |            | 3t <sub>CYC</sub> + 300 <sup>(2)</sup>  | –    | –                                | ns   |
| t <sub>SCLL</sub> | SCL input “L” width                         |            | 5t <sub>CYC</sub> + 300 <sup>(2)</sup>  | –    | –                                | ns   |
| t <sub>sf</sub>   | SCL, SDA input falling time                 |            | –                                       | –    | 300                              | ns   |
| t <sub>SP</sub>   | SCL, SDA input spike pulse rejection time   |            | –                                       | –    | 1t <sub>CYC</sub> <sup>(2)</sup> | ns   |
| t <sub>BUF</sub>  | SDA input bus-free time                     |            | 5t <sub>CYC</sub> <sup>(2)</sup>        | –    | –                                | ns   |
| t <sub>STAH</sub> | Start condition input hole time             |            | 3t <sub>CYC</sub> <sup>(2)</sup>        | –    | –                                | ns   |
| t <sub>STAS</sub> | Retransmit start condition input setup time |            | 3t <sub>CYC</sub> <sup>(2)</sup>        | –    | –                                | ns   |
| t <sub>STOP</sub> | Stop condition input setup time             |            | 3t <sub>CYC</sub> <sup>(2)</sup>        | –    | –                                | ns   |
| t <sub>SOAS</sub> | Data input setup time                       |            | 1t <sub>CYC</sub> + 20 <sup>(2)</sup>   | –    | –                                | ns   |
| t <sub>SDAH</sub> | Data input hold time                        |            | 0                                       | –    | –                                | ns   |

## NOTES:

1. V<sub>CC</sub> = 2.7 to 5.5 V, V<sub>SS</sub> = 0V at Topr = -40 to 85°C (J version) / -40 to 125°C (K version), unless otherwise specified.
2. 1t<sub>CYC</sub> = 1/f<sub>1</sub>(s)

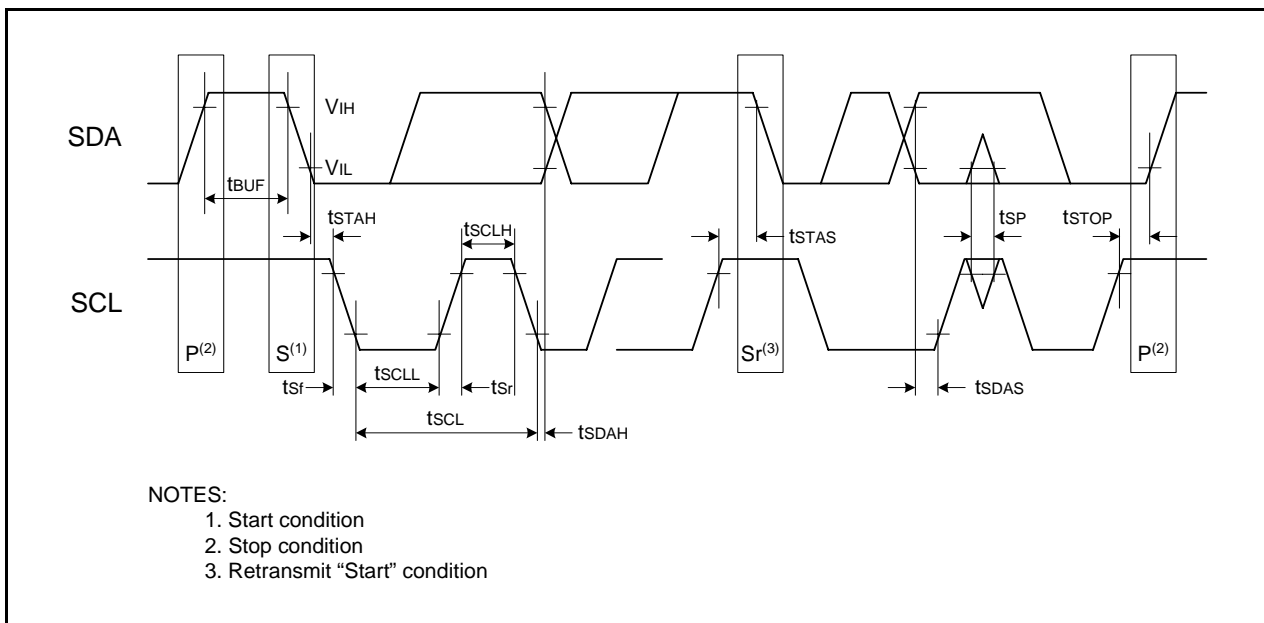
**Figure 5.7 I/O Timing of I<sup>2</sup>C Bus Interface**

**Table 5.14 Electrical Characteristics (1) [Vcc = 5 V]**

| Symbol           | Parameter           |   | Condition           |                    | Standard  |      |      | Unit       |
|------------------|---------------------|---|---------------------|--------------------|-----------|------|------|------------|
|                  |                     |   |                     |                    | Min.      | Typ. | Max. |            |
| VOH              | Output "H" Voltage  | Except XOUT   | IOH = -5 mA         |                    | Vcc - 2.0 | -    | Vcc  | V          |
|                  |                     |   | IOH = -200 $\mu$ A  |                    | Vcc - 0.3 | -    | Vcc  | V          |
|                  |                     | XOUT  | Drive capacity HIGH | IOH = -1 mA        | Vcc - 2.0 | -    | Vcc  | V          |
|                  |                     |   | Drive capacity LOW  | IOH = -500 $\mu$ A | Vcc - 2.0 | -    | Vcc  | V          |
| VOL              | Output "L" Voltage  | Except XOUT   | IOL = 5 mA          |                    | -         | -    | 2.0  | V          |
|                  |                     |   | IOL = 200 $\mu$ A   |                    | -         | -    | 0.45 | V          |
|                  |                     | XOUT  | Drive capacity HIGH | IOL = 1 mA         | -         | -    | 2.0  | V          |
|                  |                     |   | Drive capacity LOW  | IOL = 500 $\mu$ A  | -         | -    | 2.0  | V          |
| VT+ - VT-        | Hysteresis          | INT0, INT1, INT2, INT3, KI0, KI1, KI2, KI3, TRAI0, RXD0, RXD1, CLK0, SSI, SCL, SDA, SSO |                     |                    | 0.1       | 0.5  | -    | V          |
|                  |                     | RESET   |                     |                    | 0.1       | 1.0  | -    | V          |
| IiH              | Input "H" current   |   | VI = 5 V, Vcc = 5 V |                    | -         | -    | 5.0  | $\mu$ A    |
| IiL              | Input "L" current   |   | VI = 0 V, Vcc = 5 V |                    | -         | -    | -5.0 | $\mu$ A    |
| RPULLUP          | Pull-Up Resistance  |   | VI = 0 V, Vcc = 5 V |                    | 30        | 50   | 167  | k $\Omega$ |
| RfXIN            | Feedback Resistance | XIN   |                     |                    | -         | 1.0  | -    | M $\Omega$ |
| V <sub>RAM</sub> | RAM Hold Voltage    |   | During stop mode    |                    | 2.0       | -    | -    | V          |

## NOTE:

- Vcc = 4.2 to 5.5 V at T<sub>opr</sub> = -40 to 85°C (J version) / -40 to 125°C (K version), f(XIN) = 20 MHz, unless otherwise specified.

**Table 5.15 Electrical Characteristics (2) [V<sub>CC</sub> = 5 V]  
(Topr = -40 to 85°C (J version) / -40 to 125°C (K version), Unless Otherwise Specified.)**

| Symbol          | Parameter   | Condition                          | Standard  |      |      | Unit |    |
|-----------------|---|------------------------------------|---|------|------|------|----|
|                 |   |                                    | Min.  | Typ. | Max. |      |    |
| I <sub>CC</sub> | Power supply current (V <sub>CC</sub> = 3.3 to 5.5 V)<br>In single-chip mode, the output pins are open and other pins are V <sub>SS</sub> | High-clock mode                    | XIN = 20 MHz (square wave)<br>High-speed on-chip oscillator off<br>Low-speed on-chip oscillator on = 125 kHz<br>No division   | –    | 11.0 | 22.0 | mA |
|                 |   |                                    | XIN = 16 MHz (square wave)<br>High-speed on-chip oscillator off<br>Low-speed on-chip oscillator on = 125 kHz<br>No division   | –    | 8.8  | 17.6 | mA |
|                 |   |                                    | XIN = 10 MHz (square wave)<br>High-speed on-chip oscillator off<br>Low-speed on-chip oscillator on = 125 kHz<br>No division   | –    | 5.8  | –    | mA |
|                 |   |                                    | XIN = 20 MHz (square wave)<br>High-speed on-chip oscillator off<br>Low-speed on-chip oscillator on = 125 kHz<br>Divide-by-8   | –    | 5.0  | –    | mA |
|                 |   |                                    | XIN = 16MHz (square wave)<br>High-speed on-chip oscillator off<br>Low-speed on-chip oscillator on = 125 kHz<br>Divide-by-8  | –    | 3.8  | –    | mA |
|                 |   |                                    | XIN = 10 MHz (square wave)<br>High-speed on-chip oscillator off<br>Low-speed on-chip oscillator on = 125 kHz<br>Divide-by-8   | –    | 2.8  | –    | mA |
|                 |   | High-speed on-chip oscillator mode | XIN clock off<br>High-speed on-chip oscillator on f <sub>OCO</sub> = 10 MHz<br>Low-speed on-chip oscillator on = 125 kHz<br>No division   | –    | 5.8  | 11.6 | mA |
|                 |   |                                    | XIN clock off<br>High-speed on-chip oscillator on f <sub>OCO</sub> = 10 MHz<br>Low-speed on-chip oscillator on = 125 kHz<br>Divide-by-8   | –    | 2.5  | –    | mA |
|                 |   | Low-speed on-chip oscillator mode  | XIN clock off<br>High-speed on-chip oscillator off<br>Low-speed on-chip oscillator on = 125 kHz<br>Divide-by-8<br>FMR47 = 1   | –    | 143  | 286  | μA |
|                 |   | Wait mode                          | XIN clock off<br>High-speed on-chip oscillator off<br>Low-speed on-chip oscillator on = 125 kHz<br>While a WAIT instruction is executed<br>Peripheral clock operation<br>VCA20 = 0<br>VCA26 = VCA27 = 0 | –    | 53   | 106  | μA |
|                 |   |                                    | XIN clock off<br>High-speed on-chip oscillator off<br>Low-speed on-chip oscillator on = 125 kHz<br>While a WAIT instruction is executed<br>Peripheral clock off<br>VCA20 = 0<br>VCA26 = VCA27 = 0       | –    | 38   | 76   | μA |
|                 |   | Stop mode<br>Topr = 25°C           | XIN clock off<br>High-speed on-chip oscillator off<br>Low-speed on-chip oscillator off<br>CM10 = 1<br>Peripheral clock off<br>VCA26 = VCA27 = 0   | –    | 0.8  | 3.0  | μA |
|                 |   | Stop mode<br>Topr = 85°C           | XIN clock off<br>High-speed on-chip oscillator off<br>Low-speed on-chip oscillator off<br>CM10 = 1<br>Peripheral clock off<br>VCA26 = VCA27 = 0   | –    | 1.2  | –    | μA |
|                 |   | Stop mode<br>Topr = 125°C          | XIN clock off<br>High-speed on-chip oscillator off<br>Low-speed on-chip oscillator off<br>CM10 = 1<br>Peripheral clock off<br>VCA26 = VCA27 = 0   | –    | 4.0  | –    | μA |

**Timing Requirements (Unless Otherwise Specified:  $V_{CC} = 5\text{ V}$ ,  $V_{SS} = 0\text{ V}$  at  $T_{opr} = 25^\circ\text{C}$ ) [ $V_{CC} = 5\text{ V}$ ]****Table 5.16 XIN Input**

| Symbol        | Parameter            | Standard |      | Unit |
|---------------|----------------------|----------|------|------|
|               |                      | Min.     | Max. |      |
| $t_{c(XIN)}$  | XIN input cycle time | 50       | –    | ns   |
| $t_{WH(XIN)}$ | XIN input "H" width  | 25       | –    | ns   |
| $t_{WL(XIN)}$ | XIN input "L" width  | 25       | –    | ns   |

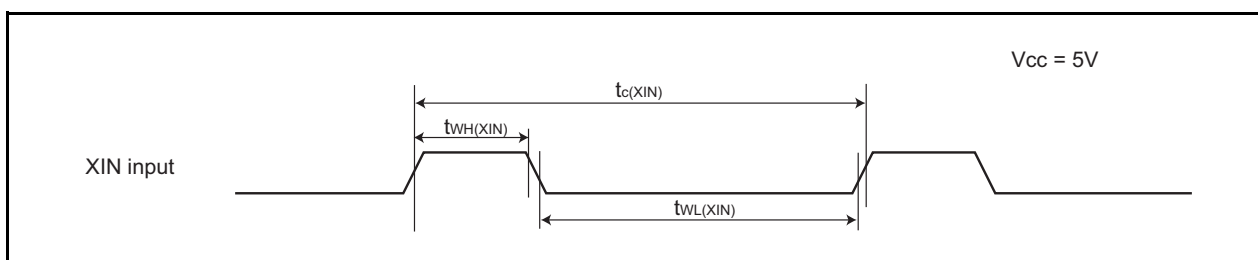
**Figure 5.8 XIN Input Timing Diagram when  $V_{CC} = 5\text{ V}$** **Table 5.17 TRAIO Input**

| Symbol          | Parameter              | Standard |      | Unit |
|-----------------|------------------------|----------|------|------|
|                 |                        | Min.     | Max. |      |
| $t_{c(TRAIO)}$  | TRAIO input cycle time | 100      | –    | ns   |
| $t_{WH(TRAIO)}$ | TRAIO input "H" width  | 40       | –    | ns   |
| $t_{WL(TRAIO)}$ | TRAIO input "L" width  | 40       | –    | ns   |

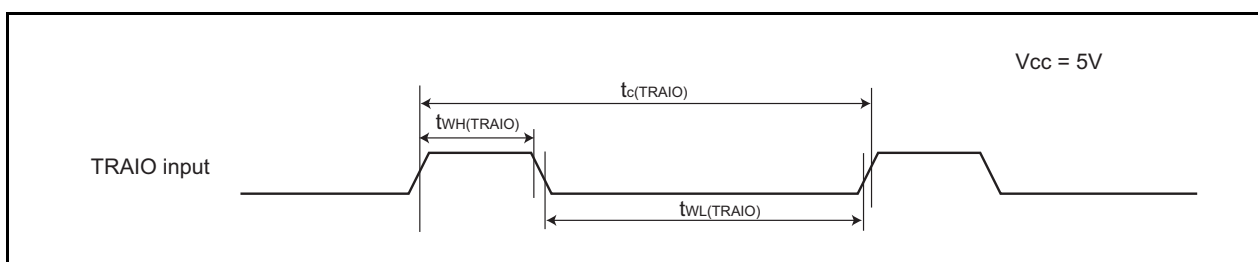
**Figure 5.9 TRAIO Input Timing Diagram when  $V_{CC} = 5\text{ V}$**

**Table 5.18 Serial Interface**

| Symbol        | Parameter              | Standard |      | Unit |
|---------------|------------------------|----------|------|------|
|               |                        | Min.     | Max. |      |
| $t_{c(CK)}$   | CLK0 input cycle time  | 200      | –    | ns   |
| $t_{w(CKH)}$  | CLK0 input “H” width   | 100      | –    | ns   |
| $t_{w(CKL)}$  | CLK0 input “L” width   | 100      | –    | ns   |
| $t_{d(C-Q)}$  | TXDi output delay time | –        | 50   | ns   |
| $t_{h(C-Q)}$  | TXDi hold time         | 0        | –    | ns   |
| $t_{su(D-C)}$ | RXDi input setup time  | 50       | –    | ns   |
| $t_{h(C-D)}$  | RXDi input hold time   | 90       | –    | ns   |

i = 0 or 1

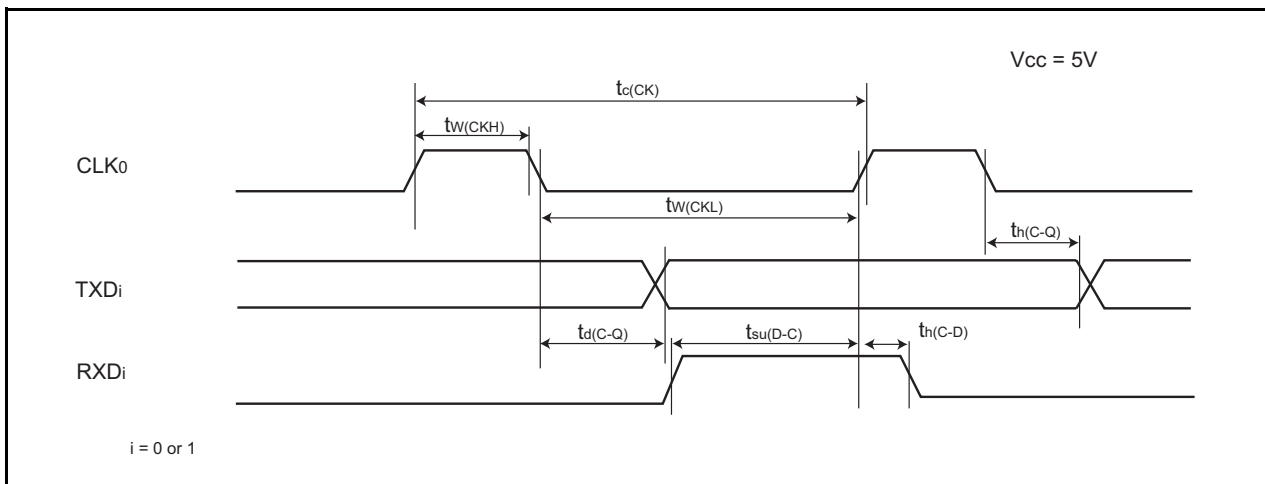
**Figure 5.10 Serial Interface Timing Diagram when Vcc = 5 V****Table 5.19 External Interrupt  $\overline{INTi}$  (i = 0 to 3) Input**

| Symbol       | Parameter                         | Standard           |      | Unit |
|--------------|-----------------------------------|--------------------|------|------|
|              |                                   | Min.               | Max. |      |
| $t_{w(INH)}$ | $\overline{INTi}$ input “H” width | 250 <sup>(1)</sup> | –    | ns   |
| $t_{w(INL)}$ | $\overline{INTi}$ input “L” width | 250 <sup>(2)</sup> | –    | ns   |

## NOTES:

- When selecting the digital filter by the  $\overline{INTi}$  input filter select bit, use the  $\overline{INTi}$  input HIGH width to the greater value, either (1/digital filter clock frequency x 3) or the minimum value of standard.
- When selecting the digital filter by the  $\overline{INTi}$  input filter select bit, use the  $\overline{INTi}$  input LOW width to the greater value, either (1/digital filter clock frequency x 3) or the minimum value of standard.

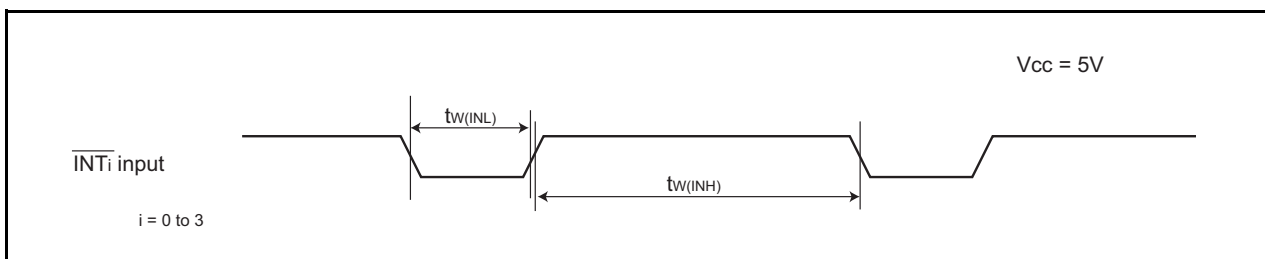
**Figure 5.11 External Interrupt  $\overline{INTi}$  Input Timing Diagram when Vcc = 5 V (i = 0 to 3)**

**Table 5.20 Electrical Characteristics (3) [Vcc = 3 V]**

| Symbol           | Parameter           |   | Condition           |               | Standard  |      |      | Unit |
|------------------|---------------------|---|---------------------|---------------|-----------|------|------|------|
|                  |                     |   |                     |               | Min.      | Typ. | Max. |      |
| VOH              | Output "H" voltage  | Except XOUT   | IOH = -1 mA         |               | Vcc - 0.5 | -    | Vcc  | V    |
|                  |                     | XOUT  | Drive capacity HIGH | IOH = -0.1 mA | Vcc - 0.5 | -    | Vcc  | V    |
|                  |                     |   | Drive capacity LOW  | IOH = -50 μA  | Vcc - 0.5 | -    | Vcc  | V    |
| VOL              | Output "L" voltage  | Except XOUT   | IOL = 1 mA          |               | -         | -    | 0.5  | V    |
|                  |                     | XOUT  | Drive capacity HIGH | IOL = 0.1 mA  | -         | -    | 0.5  | V    |
|                  |                     |   | Drive capacity LOW  | IOL = 50 μA   | -         | -    | 0.5  | V    |
| VT+-VT-          | Hysteresis          | INT0, INT1, INT2, INT3, KI0, KI1, KI2, KI3, TRAIO, RXD0, RXD1, CLK0, SSI, SCL, SDA, SSO |                     |               | 0.1       | 0.3  | -    | V    |
|                  |                     | RESET   |                     |               | 0.1       | 0.4  | -    | V    |
| IiH              | Input "H" current   |   | VI = 3 V, Vcc = 3 V |               | -         | -    | 4.0  | μA   |
| IiL              | Input "L" current   |   | VI = 0 V, Vcc = 3 V |               | -         | -    | -4.0 | μA   |
| RPULLUP          | Pull-up resistance  |   | VI = 0 V, Vcc = 3 V |               | 66        | 160  | 500  | kΩ   |
| RfXIN            | Feedback resistance | XIN   |                     |               | -         | 3.0  | -    | MΩ   |
| V <sub>RAM</sub> | RAM hold voltage    |   | During stop mode    |               | 2.0       | -    | -    | V    |

## NOTE:

- Vcc = 2.7 to 3.3 V at Topr = -40 to 85°C (J version) / -40 to 125°C (K version), f(XIN) = 10 MHz, unless otherwise specified.

**Table 5.21 Electrical Characteristics (4) [V<sub>CC</sub> = 3 V]  
(Topr = -40 to 85°C (J version) / -40 to 125°C (K version), Unless Otherwise Specified.)**

| Symbol          | Parameter   | Condition                          | Standard  |      |      | Unit |    |
|-----------------|---|------------------------------------|---|------|------|------|----|
|                 |   |                                    | Min.  | Typ. | Max. |      |    |
| I <sub>CC</sub> | Power supply current (V <sub>CC</sub> = 2.7 to 3.3 V)<br>In single-chip mode, the output pins are open and other pins are V <sub>SS</sub> | High-clock mode                    | XIN = 20 MHz (square wave)<br>High-speed on-chip oscillator off<br>Low-speed on-chip oscillator on = 125 kHz<br>No division   | –    | 10.5 | 21.0 | mA |
|                 |   |                                    | XIN = 16 MHz (square wave)<br>High-speed on-chip oscillator off<br>Low-speed on-chip oscillator on = 125 kHz<br>No division   | –    | 8.3  | 16.6 | mA |
|                 |   |                                    | XIN = 10 MHz (square wave)<br>High-speed on-chip oscillator off<br>Low-speed on-chip oscillator on = 125 kHz<br>No division   | –    | 5.3  | 10.6 | mA |
|                 |   |                                    | XIN = 20 MHz (square wave)<br>High-speed on-chip oscillator off<br>Low-speed on-chip oscillator on = 125 kHz<br>Divide-by-8   | –    | 4.5  | –    | mA |
|                 |   |                                    | XIN = 16 MHz (square wave)<br>High-speed on-chip oscillator off<br>Low-speed on-chip oscillator on = 125 kHz<br>Divide-by-8   | –    | 3.3  | –    | mA |
|                 |   |                                    | XIN = 10 MHz (square wave)<br>High-speed on-chip oscillator off<br>Low-speed on-chip oscillator on = 125 kHz<br>Divide-by-8   | –    | 2.3  | –    | mA |
|                 |   | High-speed on-chip oscillator mode | XIN clock off<br>High-speed on-chip oscillator on f <sub>OCO</sub> = 10 MHz<br>Low-speed on-chip oscillator on = 125 kHz<br>No division   | –    | 5.6  | 11.2 | mA |
|                 |   |                                    | XIN clock off<br>High-speed on-chip oscillator on f <sub>OCO</sub> = 10 MHz<br>Low-speed on-chip oscillator on = 125 kHz<br>Divide-by-8   | –    | 2.4  | –    | mA |
|                 |   | Low-speed on-chip oscillator mode  | XIN clock off<br>High-speed on-chip oscillator off<br>Low-speed on-chip oscillator on = 125 kHz<br>Divide-by-8<br>FMR47 = 1   | –    | 138  | 276  | μA |
|                 |   | Wait mode                          | XIN clock off<br>High-speed on-chip oscillator off<br>Low-speed on-chip oscillator on = 125 kHz<br>While a WAIT instruction is executed<br>Peripheral clock operation<br>VCA20 = 0<br>VCA26 = VCA27 = 0 | –    | 48   | 96   | μA |
|                 |   |                                    | XIN clock off<br>High-speed on-chip oscillator off<br>Low-speed on-chip oscillator on = 125 kHz<br>While a WAIT instruction is executed<br>Peripheral clock off<br>VCA20 = 0<br>VCA26 = VCA27 = 0       | –    | 35   | 70   | μA |
|                 |   | Stop mode<br>Topr = 25°C           | XIN clock off<br>High-speed on-chip oscillator off<br>Low-speed on-chip oscillator off<br>CM10 = 1<br>Peripheral clock off<br>VCA26 = VCA27 = 0   | –    | 0.7  | 3.0  | μA |
|                 |   | Stop mode<br>Topr = 85°C           | XIN clock off<br>High-speed on-chip oscillator off<br>Low-speed on-chip oscillator off<br>CM10 = 1<br>Peripheral clock off<br>VCA26 = VCA27 = 0   | –    | 1.1  | –    | μA |
|                 |   | Stop mode<br>Topr = 125°C          | XIN clock off<br>High-speed on-chip oscillator off<br>Low-speed on-chip oscillator off<br>CM10 = 1<br>Peripheral clock off<br>VCA26 = VCA27 = 0   | –    | 3.8  | –    | μA |



**Timing Requirements (Unless Otherwise Specified:  $V_{CC} = 3\text{ V}$ ,  $V_{SS} = 0\text{ V}$  at  $T_{op} = 25^\circ\text{C}$ ) [ $V_{CC} = 3\text{ V}$ ]****Table 5.22 XIN Input**

| Symbol        | Parameter            | Standard |      | Unit |
|---------------|----------------------|----------|------|------|
|               |                      | Min.     | Max. |      |
| $t_{c(XIN)}$  | XIN input cycle time | 100      | –    | ns   |
| $t_{WH(XIN)}$ | XIN input "H" width  | 40       | –    | ns   |
| $t_{WL(XIN)}$ | XIN input "L" width  | 40       | –    | ns   |

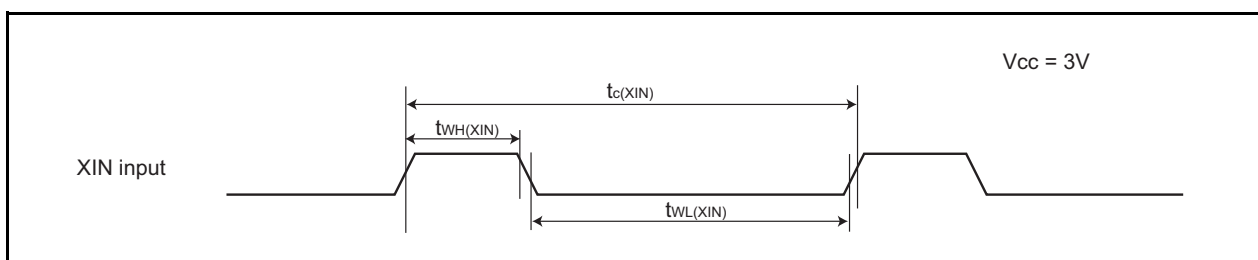
**Figure 5.12 XIN Input Timing Diagram when  $V_{CC} = 3\text{ V}$** **Table 5.23 TRAIO Input**

| Symbol          | Parameter              | Standard |      | Unit |
|-----------------|------------------------|----------|------|------|
|                 |                        | Min.     | Max. |      |
| $t_{c(TRAIO)}$  | TRAIO input Cycle time | 300      | –    | ns   |
| $t_{WH(TRAIO)}$ | TRAIO input "H" width  | 120      | –    | ns   |
| $t_{WL(TRAIO)}$ | TRAIO input "L" width  | 120      | –    | ns   |

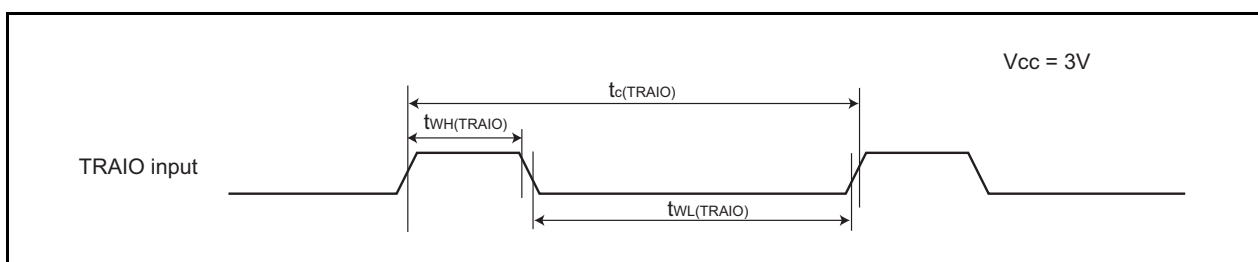
**Figure 5.13 TRAIO Input Timing Diagram when  $V_{CC} = 3\text{ V}$**

**Table 5.24 Serial Interface**

| Symbol        | Parameter              | Standard |      | Unit |
|---------------|------------------------|----------|------|------|
|               |                        | Min.     | Max. |      |
| $t_{c(CK)}$   | CLK0 input cycle time  | 300      | –    | ns   |
| $t_{w(CKH)}$  | CLK0 input “H” width   | 150      | –    | ns   |
| $t_{w(CKL)}$  | CLK0 input “L” width   | 150      | –    | ns   |
| $t_{d(C-Q)}$  | TXDi output delay time | –        | 80   | ns   |
| $t_{h(C-Q)}$  | TXDi hold time         | 0        | –    | ns   |
| $t_{su(D-C)}$ | RXDi input setup time  | 70       | –    | ns   |
| $t_{h(C-D)}$  | RXDi input hold time   | 90       | –    | ns   |

$i = 0$  or  $1$

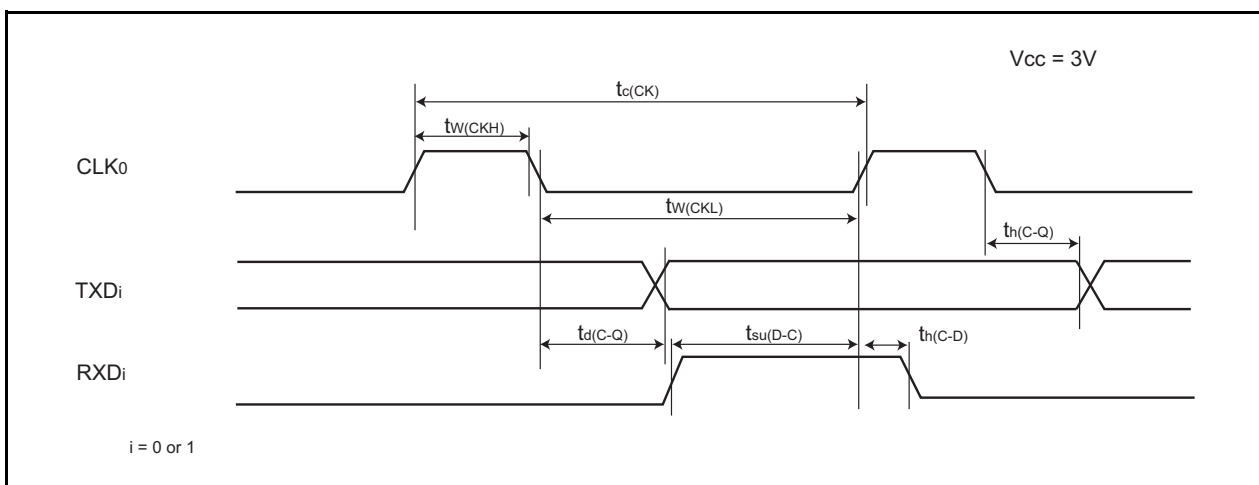

**Figure 5.14 Serial Interface Timing Diagram when  $V_{cc} = 3\text{ V}$**

**Table 5.25 External Interrupt  $\overline{INTi}$  ( $i = 0$  to  $3$ ) Input**

| Symbol       | Parameter                         | Standard           |      | Unit |
|--------------|-----------------------------------|--------------------|------|------|
|              |                                   | Min.               | Max. |      |
| $t_{w(INH)}$ | $\overline{INTi}$ input “H” width | 380 <sup>(1)</sup> | –    | ns   |
| $t_{w(INL)}$ | $\overline{INTi}$ input “L” width | 380 <sup>(2)</sup> | –    | ns   |

NOTES:

1. When selecting the digital filter by the  $\overline{INTi}$  input filter select bit, use the  $\overline{INTi}$  input HIGH width to the greater value, either (1/digital filter clock frequency x 3) or the minimum value of standard.
2. When selecting the digital filter by the  $\overline{INTi}$  input filter select bit, use the  $\overline{INTi}$  input LOW width to the greater value, either (1/digital filter clock frequency x 3) or the minimum value of standard.

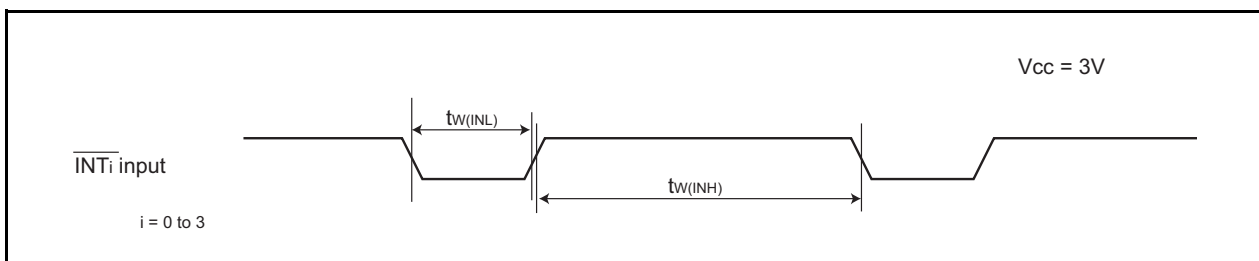

**Figure 5.15 External Interrupt  $\overline{INTi}$  Input Timing Diagram when  $V_{cc} = 3\text{ V}$  ( $i = 0$  to  $3$ )**

# Package Dimensions

Diagrams showing the latest package dimensions and mounting information are available in the “Packages” section of the Renesas Technology website.

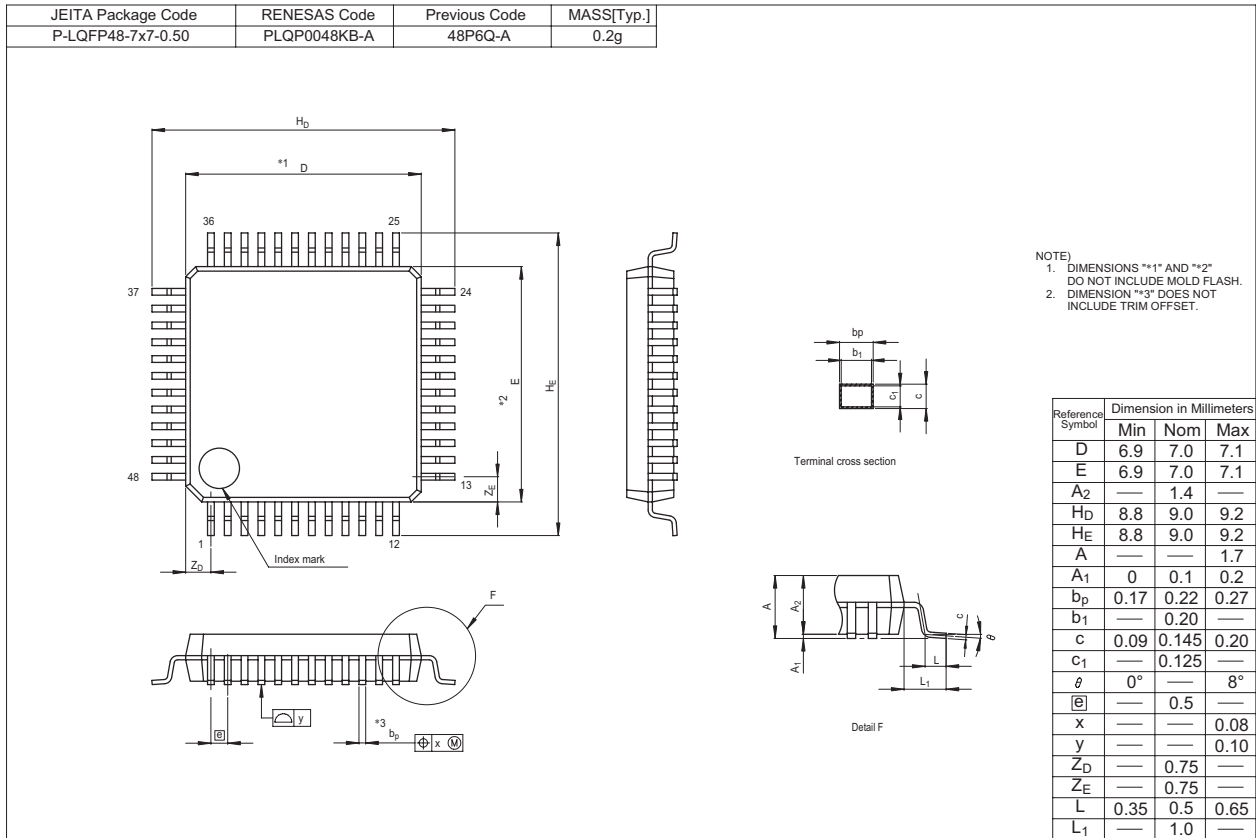

**REVISION HISTORY**
**R8C/20 Group, R8C/21 Group Datasheet**

| Rev. | Date         | Description |   |
|------|--------------|-------------|---|
|      |              | Page        | Summary   |
| 0.10 | Mar 08, 2005 | –           | First Edition issued  |
| 0.20 | Sep 29, 2005 | –           | <p>Words standardized</p> <ul style="list-style-type: none"> <li>- Clock synchronous serial interface → Clock synchronous serial I/O</li> <li>- Chip-select clock synchronous interface(SSU)                             <ul style="list-style-type: none"> <li>→ Clock synchronous serial I/O with chip select</li> </ul> </li> <li>- I<sup>2</sup>C bus interface(IIC) → I<sup>2</sup>C bus interface</li> </ul>          |
|      |              | 2, 3        | <p>Table1.1 R8C/20 Group Performance, Table1.2 R8C/21 Group Performance</p> <p>Serial Interface revised:</p> <ul style="list-style-type: none"> <li>- Clock Synchronous Serial Interface: 1 channel</li> <li>  I<sup>2</sup>C bus Interface (3), Clock synchronous serial I/O with chip select</li> <li>- Power-On Reset Circuit added</li> <li>- Power Consumption value determined</li> </ul>                             |
|      |              | 5, 6        | <p>Table 1.3 Product Information of R8C/20 Group, Table 1.4 Product Information of R8C/21 Group</p> <p>Date revised.</p>  |
|      |              | 7           | <p>Figure 1.4 Pin Assignment</p> <p>Pin name revised:</p> <ul style="list-style-type: none"> <li>- P3_5/SSCK(/SCL) → P3_5/ SCL/SSCK</li> <li>- P3_4/SCS(/SDA) → P3_4/ SDA /SCS</li> <li>- VSS → VSS/AVSS</li> <li>- VCC → VCC/AVCC</li> <li>- P1_5/RXD0(/TRAIO/INT1) → P1_5/RXD0(/TRAIO)/(INT1)</li> <li>- P6_6/INT2/(TXD1) → P6_6/INT2/TXD1</li> <li>- P6_7/INT3/(RXD1) → P6_7/INT3/RXD1</li> <li>- NOTE2 added</li> </ul> |
|      |              | 8           | <p>Table 1.5 Pin Description</p> <ul style="list-style-type: none"> <li>- Analog Power Supply Input: line added</li> <li>- I<sup>2</sup>C Bus Interface (IIC) → I<sup>2</sup>C Bus Interface</li> <li>- SSU → Clock Synchronous Serial I/O with Chip Select</li> </ul>  |
|      |              | 9           | <p>Table 1.6 Pin Name Information by Pin Number revised</p> <ul style="list-style-type: none"> <li>- Pin Number 1: (SCL) → SCL</li> <li>- Pin Number 2: (SDA) → SDA</li> <li>- Pin Number 9: VSS → VSS/AVSS</li> <li>- Pin Number 11: VCC → VCC/AVCC</li> <li>- Pin Number 26: (TXD1) → TXD1</li> <li>- Pin Number 27: (RXD1) → RXD1</li> </ul>   |
|      |              | 15          | <p>Table 4.1 SFR Information (1) revised</p> <ul style="list-style-type: none"> <li>- 0013h: XXXXXX00b → 00h</li> </ul>   |
|      |              | 17          | <p>Table 4.3 SFR Information (3) revised</p> <ul style="list-style-type: none"> <li>- 00BCh: 0000X000b → 00h/0000X000b</li> </ul>   |
|      |              | 18          | <p>Table 4.4 SFR Information (4) revised</p> <ul style="list-style-type: none"> <li>- 00D6h: 00000XXXb → 00h</li> <li>- 00F5h: UART1 Function Select Register added</li> </ul>  |
|      |              | 19          | <p>Table 4.5 SFR Information (5) revised</p> <ul style="list-style-type: none"> <li>- 0104h: TRATR → TRA</li> </ul>   |

REVISION HISTORY

R8C/20 Group, R8C/21 Group Datasheet

| Rev. | Date         | Description |   |
|------|--------------|-------------|---|
|      |              | Page        | Summary   |
| 0.20 | Sep 29, 2005 | 20          | Table 4.6 SFR Information (6) revised<br>- 0145h: POCR0 → TRDPOCR0<br>- 0146h, 0147h: TRDCNT0 → TRD0<br>- 0148h, 0149h: GRA0 → TRDGRA0<br>- 014Ah, 014Bh: GRB0 → TRDGRB0<br>- 014Ch, 014Dh: GRC0 → TRDGRC0<br>- 014Eh, 014Fh: GRD0 → TRDGRD0<br>- 0155h: POCR1 → TRDPOCR1<br>- 0156h, 0157h: TRDCNT1 → TRD1<br>- 0158h, 0159h: GRA1 → TRDGRA1<br>- 015Ah, 015Bh: GRB1 → TRDGRB1<br>- 015Ch, 015Dh: GRC1 → TRDGRC1<br>- 015Eh, 015Fh: GRD1 → TRDGRD1 |
|      |              | 22          | 5. Electrical Characteristics added   |
| 1.00 | Nov 15, 2006 | All pages   | "Preliminary" and "Under development" deleted   |
|      |              | 2           | Table 1.1 Functions and Specifications for R8C/20 Group revised.<br>NOTE1 deleted.  |
|      |              | 3           | Table 1.2 Functions and Specifications for R8C/21 Group revised.<br>NOTE1 deleted.  |
|      |              | 5           | Table 1.3 Product Information for R8C/20 Group;<br>"R5F2120AJFP (D)", "R5F2120CJFP (D)", "R5F2120AKFP (D)",<br>"R5F2120CKFP (D)", and NOTE added.<br>Figure 1.2 Type Number, Memory Size, and Package of R8C/20 Group;<br>"A: 96 KB" and "C: 128 KB" added.   |
|      |              | 6           | Table 1.4 Product Information for R8C/21 Group;<br>"R5F2121AJFP (D)", "R5F2121CJFP (D)", "R5F2121AKFP (D)",<br>"R5F2121CKFP (D)", and NOTE added.<br>Figure 1.3 Type Number, Memory Size, and Package of R8C/21 Group;<br>"A: 96 KB" and "C: 128 KB" added.   |
|      |              | 13          | Figure 3.1 Memory Map of R8C/20 Group revised.  |
|      |              | 14          | Figure 3.2 Memory Map of R8C/21 Group revised.  |
|      |              | 15          | Table 4.1 SFR Information (1)(1);<br>NOTE8; "The CSPROINI bit in the OFS register is set to 0."<br>→ "The CSPROINI bit in the OFS register is 0." revised.  |
|      |              | 21          | Table 5.1 Absolute Maximum Ratings; Power dissipation revised.<br>Table 5.2 Recommended Operating Conditions; System clock revised.   |
|      |              | 26          | Table 5.8 Voltage Monitor 1 Reset Circuit Electrical Characteristics<br>→ Table 5.8 Power-on Reset Circuit, Voltage Monitor 1 Reset Circuit<br>Electrical Characteristics <sup>(1)</sup> replaced.<br>Table 5.8 revised.<br>NOTE3 added.<br>Table 5.9 Power-on Reset Circuit Electrical Characteristics deleted.<br>Figure 5.3 Power-on Reset Circuit Electrical Characteristics revised.   |
|      |              | 27          | Table 5.10 High-Speed On-Chip Oscillator Circuit Electrical<br>Characteristics → Table 5.9 High-Speed On-Chip Oscillator Circuit<br>Electrical Characteristics revised.   |

**REVISION HISTORY**
**R8C/20 Group, R8C/21 Group Datasheet**

| Rev. | Date  | Description |   |
|------|---|-------------|---|
|      |   | Page        | Summary   |
| 1.00 | Nov 15, 2006  | 33          | Table 5.15 Electrical Characteristics (1) [VCC = 5 V]<br>→ Table 5.14 Electrical Characteristics (1) [VCC = 5 V] revised.<br>RAM Hold Voltage, Min.; “1.8” → “2.0” corrected. |
|      |   | 34          | Table 5.16 Electrical Characteristics (2) [Vcc = 5 V]<br>→ Table 5.15 Electrical Characteristics (2) [Vcc = 5 V] revised.<br>Wait mode revised.                               |
|      |   | 37          | Table 5.21 Electrical Characteristics (3) [VCC = 3 V]<br>→ Table 5.20 Electrical Characteristics (3) [VCC = 3 V] revised.<br>RAM hold voltage, Min.; “1.8” → “2.0” corrected. |
|      |   | 38          | Table 5.22 Electrical Characteristics (4) [Vcc = 3 V]<br>→ Table 5.21 Electrical Characteristics (4) [Vcc = 3 V] revised.<br>Wait mode revised.                               |
| 2.00 | Aug 27, 2008  | –           | “RENESAS TECHNICAL UPDATE” reflected: TN-16C-A172A/E  |
|      |   | 5, 6        | Table 1.3, Table 1.4 revised<br>Figure 1.2, Figure 1.3; ROM number “XXX” added  |
|      |   | 13, 14      | Figure 3.1, Figure 3.2; “Expanding area” deleted  |
|      |   | 21          | Table 5.2; NOTE2 revised  |
|      |   | 23          | Table 5.4; NOTE2 and NOTE4 revised  |
|      |   | 24          | Table 5.5; NOTE2 and NOTE5 revised  |
|      |   | 25          | Table 5.6; “td(Vdet1-A)” added, NOTE5 added<br>Table 5.7; “td(Vdet2-A)” and NOTE2 revised, NOTE5 added  |
| 26   | Table 5.8; “trth” and NOTE2 revised<br>Figure 5.3 revised |             |   |
|      |   |             |   |

All trademarks and registered trademarks are the property of their respective owners.

Notes:

1. This document is provided for reference purposes only so that Renesas customers may select the appropriate Renesas products for their use. Renesas neither makes warranties or representations with respect to the accuracy or completeness of the information contained in this document nor grants any license to any intellectual property rights or any other rights of Renesas or any third party with respect to the information in this document.
2. Renesas shall have no liability for damages or infringement of any intellectual property or other rights arising out of the use of any information in this document, including, but not limited to, product data, diagrams, charts, programs, algorithms, and application circuit examples.
3. You should not use the products or the technology described in this document for the purpose of military applications such as the development of weapons of mass destruction or for the purpose of any other military use. When exporting the products or technology described herein, you should follow the applicable export control laws and regulations, and procedures required by such laws and regulations.
4. All information included in this document such as product data, diagrams, charts, programs, algorithms, and application circuit examples, is current as of the date this document is issued. Such information, however, is subject to change without any prior notice. Before purchasing or using any Renesas products listed in this document, please confirm the latest product information with a Renesas sales office. Also, please pay regular and careful attention to additional and different information to be disclosed by Renesas such as that disclosed through our website. (<http://www.renesas.com>)
5. Renesas has used reasonable care in compiling the information included in this document, but Renesas assumes no liability whatsoever for any damages incurred as a result of errors or omissions in the information included in this document.
6. When using or otherwise relying on the information in this document, you should evaluate the information in light of the total system before deciding about the applicability of such information to the intended application. Renesas makes no representations, warranties or guarantees regarding the suitability of its products for any particular application and specifically disclaims any liability arising out of the application and use of the information in this document or Renesas products.
7. With the exception of products specified by Renesas as suitable for automobile applications, Renesas products are not designed, manufactured or tested for applications or otherwise in systems the failure or malfunction of which may cause a direct threat to human life or create a risk of human injury or which require especially high quality and reliability such as safety systems, or equipment or systems for transportation and traffic, healthcare, combustion control, aerospace and aeronautics, nuclear power, or undersea communication transmission. If you are considering the use of our products for such purposes, please contact a Renesas sales office beforehand. Renesas shall have no liability for damages arising out of the uses set forth above.
8. Notwithstanding the preceding paragraph, you should not use Renesas products for the purposes listed below:
  - (1) artificial life support devices or systems
  - (2) surgical implantations
  - (3) healthcare intervention (e.g., excision, administration of medication, etc.)
  - (4) any other purposes that pose a direct threat to human lifeRenesas shall have no liability for damages arising out of the uses set forth in the above and purchasers who elect to use Renesas products in any of the foregoing applications shall indemnify and hold harmless Renesas Technology Corp., its affiliated companies and their officers, directors, and employees against any and all damages arising out of such applications.
9. You should use the products described herein within the range specified by Renesas, especially with respect to the maximum rating, operating supply voltage range, movement power voltage range, heat radiation characteristics, installation and other product characteristics. Renesas shall have no liability for malfunctions or damages arising out of the use of Renesas products beyond such specified ranges.
10. Although Renesas endeavors to improve the quality and reliability of its products, IC products have specific characteristics such as the occurrence of failure at a certain rate and malfunctions under certain use conditions. Please be sure to implement safety measures to guard against the possibility of physical injury, and injury or damage caused by fire in the event of the failure of a Renesas product, such as safety design for hardware and software including but not limited to redundancy, fire control and malfunction prevention, appropriate treatment for aging degradation or any other applicable measures. Among others, since the evaluation of microcomputer software alone is very difficult, please evaluate the safety of the final products or system manufactured by you.
11. In case Renesas products listed in this document are detached from the products to which the Renesas products are attached or affixed, the risk of accident such as swallowing by infants and small children is very high. You should implement safety measures so that Renesas products may not be easily detached from your products. Renesas shall have no liability for damages arising out of such detachment.
12. This document may not be reproduced or duplicated, in any form, in whole or in part, without prior written approval from Renesas.
13. Please contact a Renesas sales office if you have any questions regarding the information contained in this document, Renesas semiconductor products, or if you have any other inquiries.



**RENESAS SALES OFFICES**

<http://www.renesas.com>

Refer to "<http://www.renesas.com/en/network>" for the latest and detailed information.

**Renesas Technology America, Inc.**  
450 Holger Way, San Jose, CA 95134-1368, U.S.A  
Tel: <1> (408) 382-7500, Fax: <1> (408) 382-7501

**Renesas Technology Europe Limited**  
Dukes Meadow, Millboard Road, Bourne End, Buckinghamshire, SL8 5FH, U.K.  
Tel: <44> (1628) 585-100, Fax: <44> (1628) 585-900

**Renesas Technology (Shanghai) Co., Ltd.**  
Unit 204, 205, AZIACenter, No.1233 Lujiazui Ring Rd, Pudong District, Shanghai, China 200120  
Tel: <86> (21) 5877-1818, Fax: <86> (21) 6887-7858/7898

**Renesas Technology Hong Kong Ltd.**  
7th Floor, North Tower, World Finance Centre, Harbour City, Canton Road, Tsimshatsui, Kowloon, Hong Kong  
Tel: <852> 2265-6688, Fax: <852> 2377-3473

**Renesas Technology Taiwan Co., Ltd.**  
10th Floor, No.99, Fushing North Road, Taipei, Taiwan  
Tel: <886> (2) 2715-2888, Fax: <886> (2) 3518-3399

**Renesas Technology Singapore Pte. Ltd.**  
1 Harbour Front Avenue, #06-10, Keppel Bay Tower, Singapore 098632  
Tel: <65> 6213-0200, Fax: <65> 6278-8001

**Renesas Technology Korea Co., Ltd.**  
Kukje Center Bldg. 18th Fl., 191, 2-ka, Hangang-ro, Yongsan-ku, Seoul 140-702, Korea  
Tel: <82> (2) 796-3115, Fax: <82> (2) 796-2145

**Renesas Technology Malaysia Sdn. Bhd**  
Unit 906, Block B, Menara Amcorp, Amcorp Trade Centre, No.18, Jln Persiaran Barat, 46050 Petaling Jaya, Selangor Darul Ehsan, Malaysia  
Tel: <603> 7955-9390, Fax: <603> 7955-9510

# Mouser Electronics

Authorized Distributor

Click to View Pricing, Inventory, Delivery & Lifecycle Information:

## Renesas Electronics:

[R5F2121AJFP#U0](#) [R5F21217KFP#U1](#) [R5F2121AKFP#U0](#) [R5F21216KFP#U1](#) [R5F21218JFP#U1](#)  
[R5F2120CKFP#U0](#) [R5F21217JFP](#) [R5F2121CKFP#U0](#) [R5F21206JFP#U1](#) [R5F21206KFP#U1](#) [R5F21216JFP#U1](#)  
[R5F21208JFP#U1](#) [R5F21208KFP#U1](#) [R5F21216JFP](#) [R5F21217JFP#U1](#) [R5F2120AKFP#U0](#) [R5F2120CJFP#U0](#)  
[R5F2121CJFP#U0](#) [R5F2120AJFP#U0](#) [R5F21207JFP#U1](#) [R5F21217KFP#W5](#)





Компания «ЭлектроПласт» предлагает заключение долгосрочных отношений при поставках импортных электронных компонентов на взаимовыгодных условиях!

Наши преимущества:

- Оперативные поставки широкого спектра электронных компонентов отечественного и импортного производства напрямую от производителей и с крупнейших мировых складов;
- Поставка более 17-ти миллионов наименований электронных компонентов;
- Поставка сложных, дефицитных, либо снятых с производства позиций;
- Оперативные сроки поставки под заказ (от 5 рабочих дней);
- Экспресс доставка в любую точку России;
- Техническая поддержка проекта, помощь в подборе аналогов, поставка прототипов;
- Система менеджмента качества сертифицирована по Международному стандарту ISO 9001;
- Лицензия ФСБ на осуществление работ с использованием сведений, составляющих государственную тайну;
- Поставка специализированных компонентов (Xilinx, Altera, Analog Devices, Intersil, Interpoint, Microsemi, Aeroflex, Peregrine, Syfer, Eurofarad, Texas Instrument, Miteq, Cobham, E2V, MA-COM, Hittite, Mini-Circuits, General Dynamics и др.);

Помимо этого, одним из направлений компании «ЭлектроПласт» является направление «Источники питания». Мы предлагаем Вам помощь Конструкторского отдела:

- Подбор оптимального решения, техническое обоснование при выборе компонента;
- Подбор аналогов;
- Консультации по применению компонента;
- Поставка образцов и прототипов;
- Техническая поддержка проекта;
- Защита от снятия компонента с производства.



#### Как с нами связаться

**Телефон:** 8 (812) 309 58 32 (многоканальный)

**Факс:** 8 (812) 320-02-42

**Электронная почта:** [org@eplast1.ru](mailto:org@eplast1.ru)

**Адрес:** 198099, г. Санкт-Петербург, ул. Калинина, дом 2, корпус 4, литера А.