

**MMS006AA Datasheet**  
**DC–20 GHz GaAs MMIC SP2T Non-Reflective**  
**Switch**



**Microsemi Corporate Headquarters**

One Enterprise, Aliso Viejo,  
CA 92656 USA

Within the USA: +1 (800) 713-4113

Outside the USA: +1 (949) 380-6100

Fax: +1 (949) 215-4996

Email: [sales.support@microsemi.com](mailto:sales.support@microsemi.com)

[www.microsemi.com](http://www.microsemi.com)

©2016 Microsemi Corporation. All rights reserved. Microsemi and the Microsemi logo are registered trademarks of Microsemi Corporation. All other trademarks and service marks are the property of their respective owners.

Microsemi makes no warranty, representation, or guarantee regarding the information contained herein or the suitability of its products and services for any particular purpose, nor does Microsemi assume any liability whatsoever arising out of the application or use of any product or circuit. The products sold hereunder and any other products sold by Microsemi have been subject to limited testing and should not be used in conjunction with mission-critical equipment or applications. Any performance specifications are believed to be reliable but are not verified, and Buyer must conduct and complete all performance and other testing of the products, alone and together with, or installed in, any end-products. Buyer shall not rely on any data and performance specifications or parameters provided by Microsemi. It is the Buyer's responsibility to independently determine suitability of any products and to test and verify the same. The information provided by Microsemi hereunder is provided "as is, where is" and with all faults, and the entire risk associated with such information is entirely with the Buyer. Microsemi does not grant, explicitly or implicitly, to any party any patent rights, licenses, or any other IP rights, whether with regard to such information itself or anything described by such information. Information provided in this document is proprietary to Microsemi, and Microsemi reserves the right to make any changes to the information in this document or to any products and services at any time without notice.

**About Microsemi**

Microsemi Corporation (Nasdaq: MSCC) offers a comprehensive portfolio of semiconductor and system solutions for aerospace & defense, communications, data center and industrial markets. Products include high-performance and radiation-hardened analog mixed-signal integrated circuits, FPGAs, SoCs and ASICs; power management products; timing and synchronization devices and precise time solutions, setting the world's standard for time; voice processing devices; RF solutions; discrete components; enterprise storage and communication solutions; security technologies and scalable anti-tamper products; Ethernet solutions; Power-over-Ethernet ICs and midspans; as well as custom design capabilities and services. Microsemi is headquartered in Aliso Viejo, California, and has approximately 4,800 employees globally. Learn more at [www.microsemi.com](http://www.microsemi.com).

---

# 1 Revision History

---

The revision history describes the changes that were implemented in the document. The changes are listed by revision, starting with the most current publication.

## 1.1 Revision 1.0

Revision 1.0 was the first publication of this document.

---

## Contents

---

1	Revision History.....	3
1.1	Revision 1.0.....	3
2	Product Overview .....	7
2.1	Functional Block Diagram .....	7
2.2	Applications .....	7
2.3	Key Features.....	7
3	Electrical Specifications.....	9
3.1	Absolute Maximum Ratings .....	9
3.2	Typical Electrical Performance .....	9
3.3	Typical Performance Curves.....	9
3.4	Control Voltages.....	12
4	Chip Outline Drawing, Die Packaging, Bond Pad, and Assembly Information .....	13
4.1	Chip Outline Drawing.....	13
4.2	Die Packaging Information .....	13
4.3	Bond Pad Information .....	14
4.4	Assembly Diagram .....	14
5	Handling and Die Attachment Recommendations.....	15
6	Ordering Information .....	16

---

## List of Figures

---

Figure 1 Functional Block Diagram .....	7
Figure 2 Insertion Loss vs. Temperature .....	10
Figure 3 Isolation vs. Temperature .....	10
Figure 4 Return Loss vs. Temperature .....	11
Figure 5 0.1 dB and 1 dB Input Compression Point .....	11
Figure 6 Input Third Order Intercept Point .....	12
Figure 7 Chip Outline .....	13
Figure 8 Assembly Diagram .....	14

---

## List of Tables

---

Table 1 Absolute Maximum Ratings .....	9
Table 2 Typical Electrical Performance .....	9
Table 3 Switch Control Truth Table.....	12
Table 4 Digital Control Voltages.....	12
Table 5 Die Packaging Information .....	13
Table 6 Bond Pad Information .....	14
Table 7 Ordering Information .....	16

## 2 Product Overview

The MMS006AA device is a DC-to-20 GHz, non-reflective gallium arsenide (GaAs) pseudomorphic high-electron mobility transistor (pHEMT), high isolation single pole double throw (SPDT) monolithic microwave integrated circuit (MMIC) chip.

The switch delivers over 40 dB of isolation across the entire DC-to-20 GHz frequency range, while maintaining a low insertion loss of less than 2 dB. The MMS006AA device operates using two negative control voltage logic lines of  $-5$  V and  $0$  V, respectively. It requires no  $V_{EE}$ , and consumes essentially zero current. The RF ports are internally matched to  $50\ \Omega$ , which allows for easy integration into multi-chip modules (MCMs).

### 2.1 Functional Block Diagram

The following illustration shows the primary functional blocks of the MMS006AA device.

**Figure 1 Functional Block Diagram**

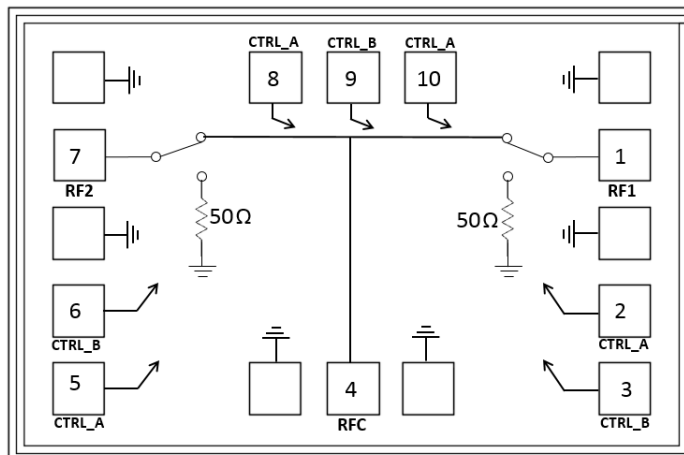

### 2.2 Applications

The MMS006AA device is designed for the following applications:

- Test instrumentation
- Military radar, radio, EW and ECM applications
- General purpose microwave applications

### 2.3 Key Features

The following are key features of the MMS006AA device.

- Non-reflective topology
- Fast switching:  $<10$  ns
- Low insertion loss:  $<2$  dB
- Excellent isolation:  $>40$  dB

- Compact die size: 0.85 mm × 1.30 mm × 0.1 mm
- High Input P1dB: 24 dBm
- High Input IP3: 42 dBm



## 3 Electrical Specifications

### 3.1 Absolute Maximum Ratings

The following table shows the absolute maximum ratings of the MMS006AA device.

**Table 1 Absolute Maximum Ratings**

Parameter	Rating
Storage temperature	–65 °C to 150 °C
Operating temperature	–40 °C to 85 °C
RF input power	30 dBm
Control voltage range (A/B)	0.5 V to –7.5 V
Hot switching power	27 dBm
Channel temperature	150 °C
ESD HBM	Class 1A

### 3.2 Typical Electrical Performance

The following table shows the typical electrical performance of the MMS006AA device at 25 °C, where  $V_{\text{CONTROL}}$  is 0 V, –5 V, and  $V_{\text{EE}}$  is –5 V. The system is 50  $\Omega$ .

**Table 2 Typical Electrical Performance**

Parameter	Test Conditions	Min	Typ	Max	Units
Operational frequency range		DC		20	GHz
Control voltage	Low	–3.0		0	V
	High	–5.0		–4.2	V
Insertion loss (all states)	DC–20 GHz			2.0	dB
Isolation	DC–20 GHz	–40			dB
Return loss (all states)	DC–20 GHz		–15		dB
$T_{\text{RISE}}, T_{\text{FALL}}$	DC–20 GHz (10% to 90% and 90% to 10% RF)		10	10	ns
$T_{\text{ON}}, T_{\text{OFF}}$	DC–20 GHz (50% control to 90% RF, and 50% control to 90% RF)		10		ns
Input P1dB	DC–20 GHz		24		dBm
Input third order intercept (IIP3)	DC–20 GHz (two-tone input power, 7 dBm/tone)		42		dBm

### 3.3 Typical Performance Curves

The following graphs show the typical performance curves of the MMS006AA device.

Figure 2 Insertion Loss vs. Temperature

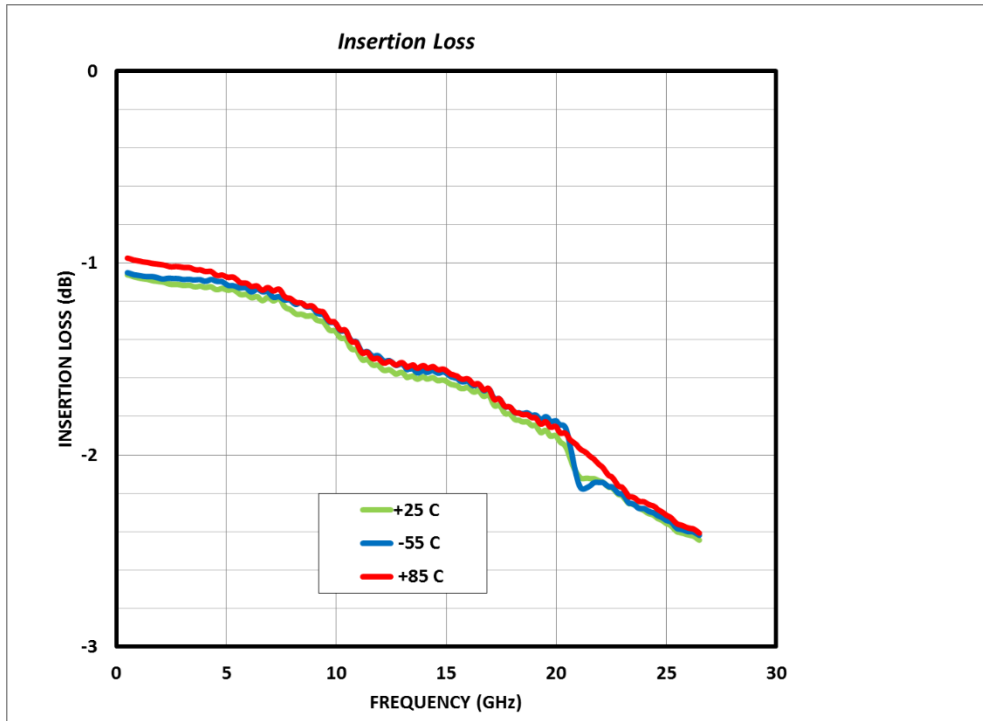

Figure 3 Isolation vs. Temperature

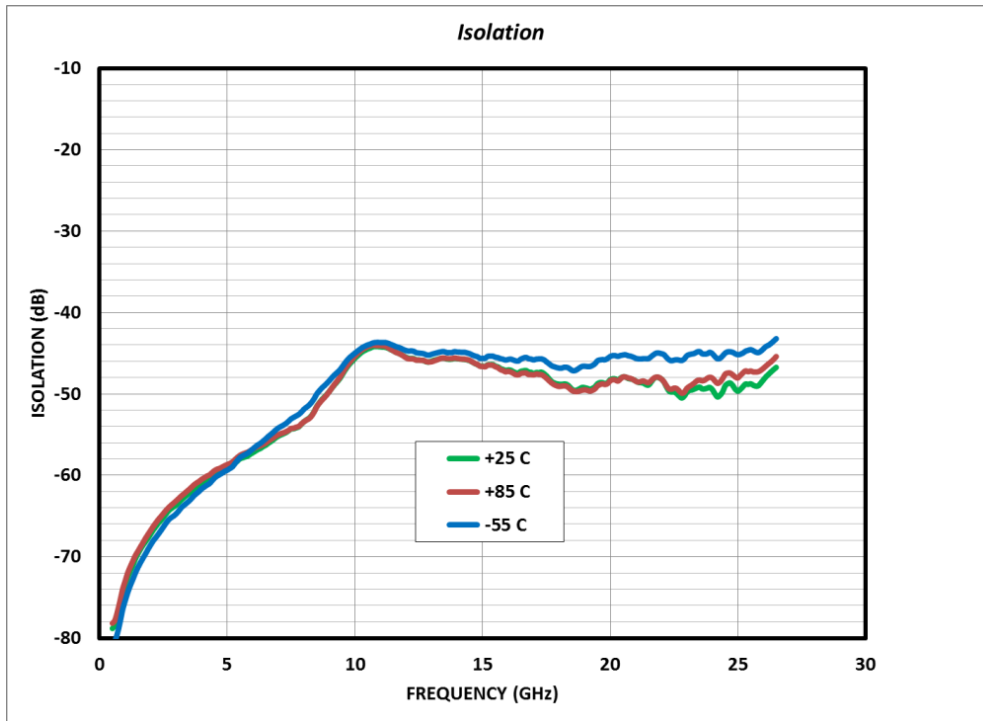

Figure 4 Return Loss vs. Temperature

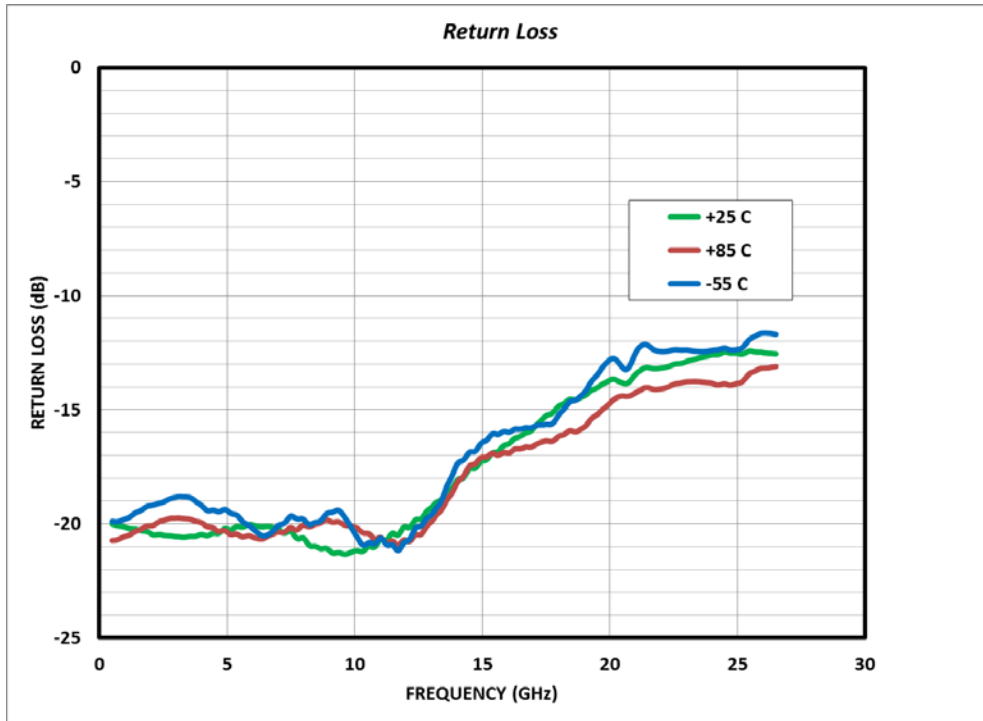
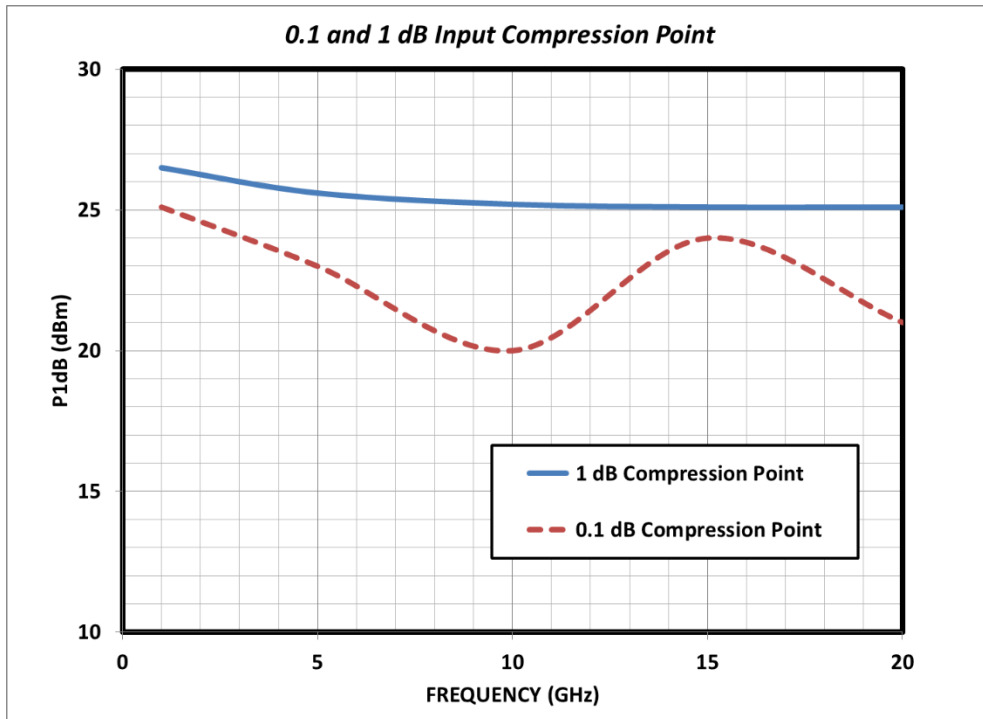
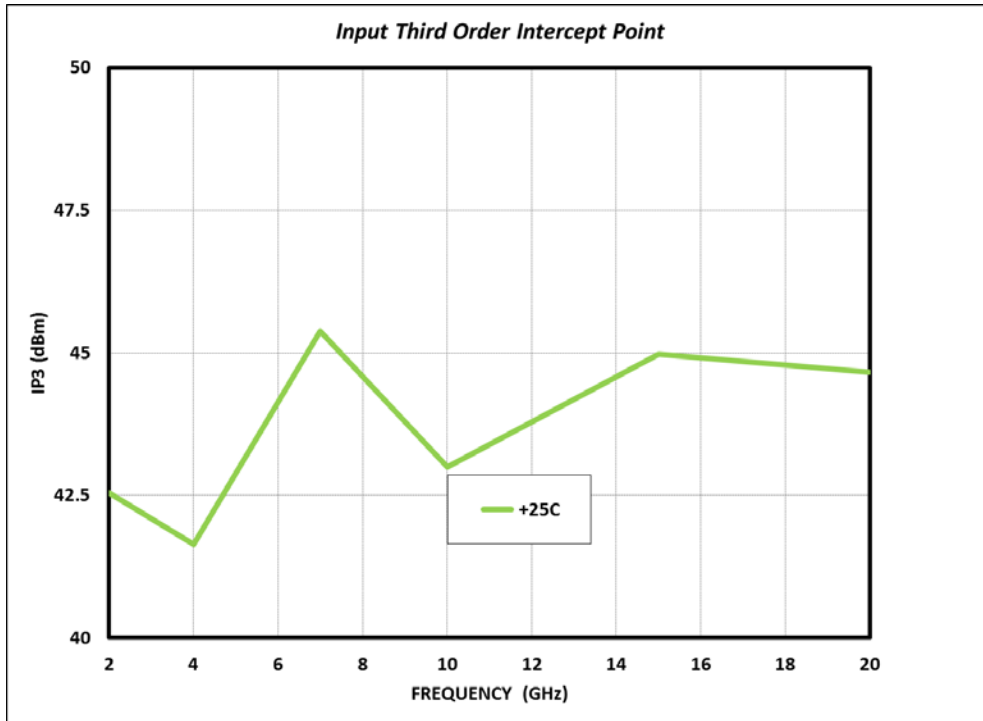

Figure 5 0.1 dB and 1 dB Input Compression Point



**Figure 6 Input Third Order Intercept Point**



### 3.4 Control Voltages

The following tables show the control voltages of the MMS006AA device.

**Table 3 Switch Control Truth Table**

Control Input		Signal Path Condition	
A	B	RF Common to RF1	RF Common to RF2
High	Low	On	Off
Low	High	Off	On

**Table 4 Digital Control Voltages**

State	Bias Condition
Low	–3 V to 0 V
High	–5.0 V to –4.2 V

## 4 Chip Outline Drawing, Die Packaging, Bond Pad, and Assembly Information

### 4.1 Chip Outline Drawing

The following illustration shows the chip outline of the MMS006AA device. Dimensions are shown in inches and millimeters. The minimum bond pad size is 100 μm × 100 μm. Both the bond pad surface and the backside metal are 3 μm gold. The die thickness is 100 μm. The backside is the DC/RF ground. The airbridge keepout region is in crosshatch, and the unlabeled pads should not be bonded.

Figure 7 Chip Outline

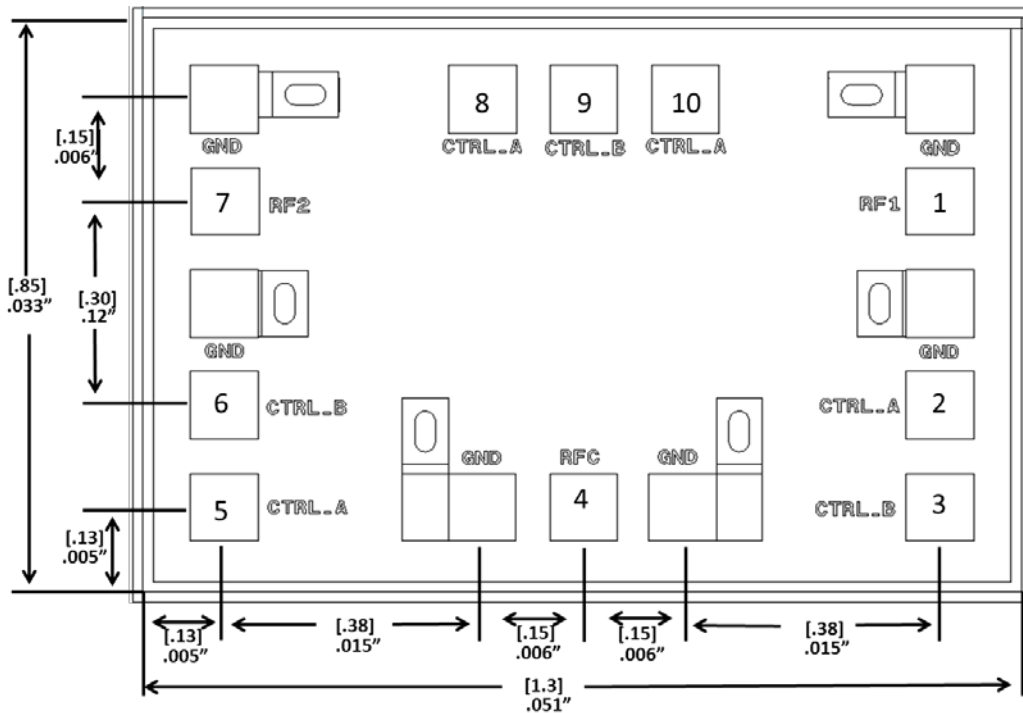

### 4.2 Die Packaging Information

The following table shows the chip outline of the MMS006AA device. For additional packaging information, contact your Microsemi sales representative.

Table 5 Die Packaging Information

Standard Format	Optional Format
Waffle pack	Gel pack
50–100 pieces per pack	50 pieces per pack

### 4.3 Bond Pad Information

The following table shows the bond pad information for the MMS006AA device.

**Table 6 Bond Pad Information**

Bond Pad Number	Bond Pad Name	Description
1, 7	RF1, RF2	RF output 1 and RF output 2. These bond pads are DC-coupled and matched to 50 Ω. DC-blocking capacitors are required.
2, 5, 8, 10 3, 6, 9	CTRLA CTRLB	Digital control voltages. Refer to Control Voltages section.
4	RFC	RF common. DC-blocking capacitor is required.
8	V <sub>EE</sub>	DC voltage supply: –5.0 VDC ±10%.
Backside Paddle	RF/DC GND	RF/DC ground.

### 4.4 Assembly Diagram

The following illustration shows the assembly diagram of the MMS006AA device.

**Figure 8 Assembly Diagram**

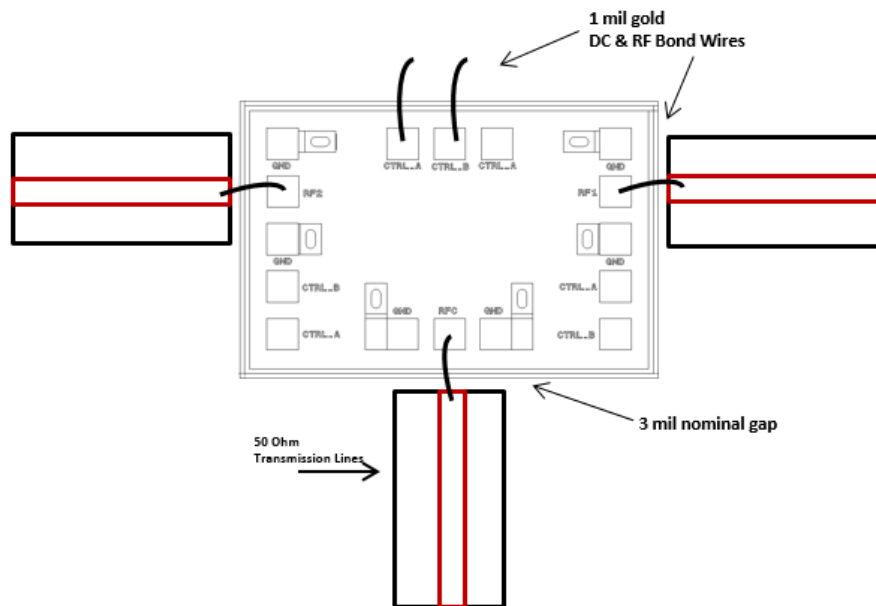

---

## 5 Handling and Die Attachment Recommendations

---

Gallium arsenide integrated circuits are sensitive to electrostatic discharge (ESD) and can be damaged by static electricity. It is recommended to follow all procedures and guidelines outlined in the Microsemi application note [AN01 GaAs MMIC Handling and Die Attach Recommendations](#).

---

## 6 Ordering Information

---

The following table shows the ordering information for the MMS006AA device.

**Table 7 Ordering Information**

Part Number	Package
MMS006AA	Die





Компания «ЭлектроПласт» предлагает заключение долгосрочных отношений при поставках импортных электронных компонентов на взаимовыгодных условиях!

Наши преимущества:

- Оперативные поставки широкого спектра электронных компонентов отечественного и импортного производства напрямую от производителей и с крупнейших мировых складов;
- Поставка более 17-ти миллионов наименований электронных компонентов;
- Поставка сложных, дефицитных, либо снятых с производства позиций;
- Оперативные сроки поставки под заказ (от 5 рабочих дней);
- Экспресс доставка в любую точку России;
- Техническая поддержка проекта, помощь в подборе аналогов, поставка прототипов;
- Система менеджмента качества сертифицирована по Международному стандарту ISO 9001;
- Лицензия ФСБ на осуществление работ с использованием сведений, составляющих государственную тайну;
- Поставка специализированных компонентов (Xilinx, Altera, Analog Devices, Intersil, Interpoint, Microsemi, Aeroflex, Peregrine, Syfer, Eurofarad, Texas Instrument, Miteq, Cobham, E2V, MA-COM, Hittite, Mini-Circuits, General Dynamics и др.);

Помимо этого, одним из направлений компании «ЭлектроПласт» является направление «Источники питания». Мы предлагаем Вам помощь Конструкторского отдела:

- Подбор оптимального решения, техническое обоснование при выборе компонента;
- Подбор аналогов;
- Консультации по применению компонента;
- Поставка образцов и прототипов;
- Техническая поддержка проекта;
- Защита от снятия компонента с производства.



#### Как с нами связаться

**Телефон:** 8 (812) 309 58 32 (многоканальный)

**Факс:** 8 (812) 320-02-42

**Электронная почта:** [org@eplast1.ru](mailto:org@eplast1.ru)

**Адрес:** 198099, г. Санкт-Петербург, ул. Калинина, дом 2, корпус 4, литера А.