

Analog Devices Welcomes Hittite Microwave Corporation

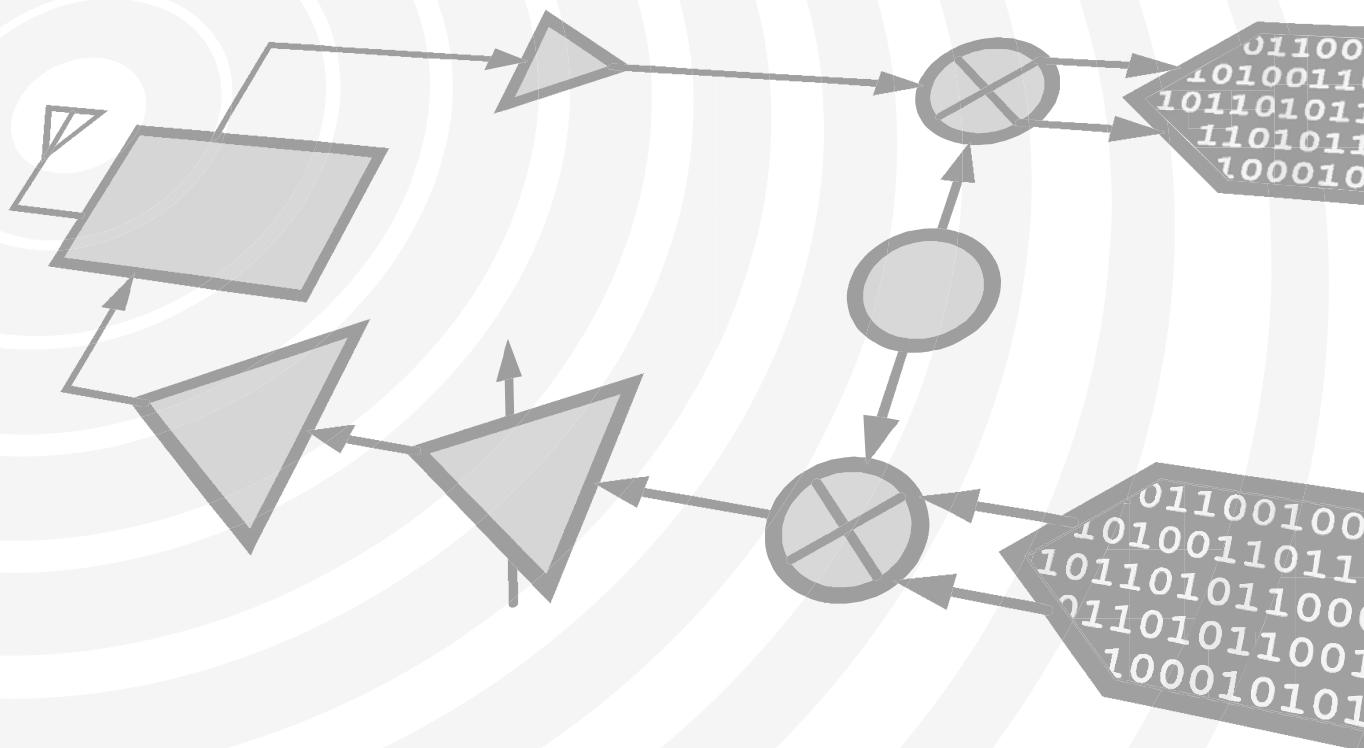

THIS PAGE INTENTIONALLY LEFT BLANK



GaAs MMIC 6-BIT DIGITAL PHASE SHIFTER, 2.5 - 3.1 GHz

Typical Applications

The HMC647ALP6E is ideal for:

- EW Receivers
- Weather & Military Radar
- Satellite Communications
- Beamforming Modules
- Phase Cancellation

Features

- Low RMS Phase Error: 1.5°
- Low Insertion Loss: 4 dB
- High Linearity: +50 dBm
- Positive Control Logic
- 360° Coverage, LSB = 5.625°
- 28 Lead QFN Leadless SMT Package: 36mm²

Functional Diagram

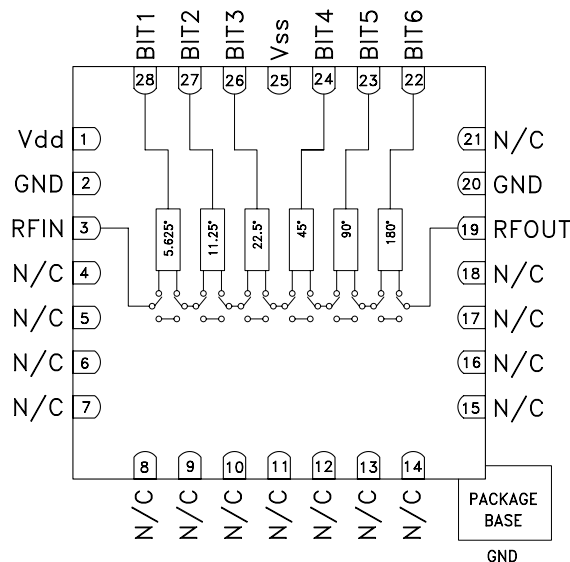

General Description

The HMC647ALP6E is a 6-bit digital phase shifter which is rated from 2.5 to 3.1 GHz, providing 360 degrees of phase coverage, with a LSB of 5.625 degrees. The HMC647ALP6E features very low RMS phase error of 1.5 degrees and extremely low insertion loss variation of ±0.4 dB across all phase states. This high accuracy phase shifter is controlled with positive control logic of 0/+5V. The HMC647ALP6E is housed in a compact 6x6 mm plastic leadless SMT package and is internally matched to 50 Ohms with no external components.

Electrical Specifications

$T_A = +25^\circ\text{C}$, $V_{SS} = -5\text{V}$, $V_{DD} = +5\text{V}$, control Voltage = 0/+5V, 50 Ohm System

Parameter	Min.	Typ.	Max.	Units
Frequency Range	2.5		3.1	GHz
Insertion Loss*		4	6.5	dB
Input Return Loss*		16		dB
Output Return Loss*		16		dB
Phase Error*		±5	+6 / -15	deg
RMS Phase Error		1.5		deg
Insertion Loss Variation*		±0.4		dB
Input Power for 1 dB Compression		31		dBm
Input Third Order Intercept		50		dBm
Control Voltage Current		35	250	µA
Bias Control Current		5	15	mA

*Note: Major States Shown



**GaAs MMIC 6-BIT DIGITAL
 PHASE SHIFTER, 2.5 - 3.1 GHz**

Insertion Loss, Major States Only

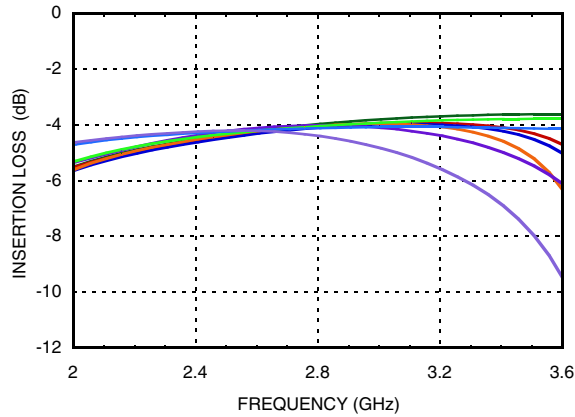

Normalized Loss, Major States Only

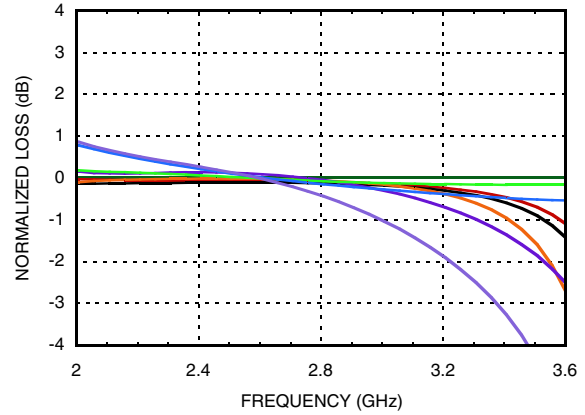

Input Return Loss, Major States Only

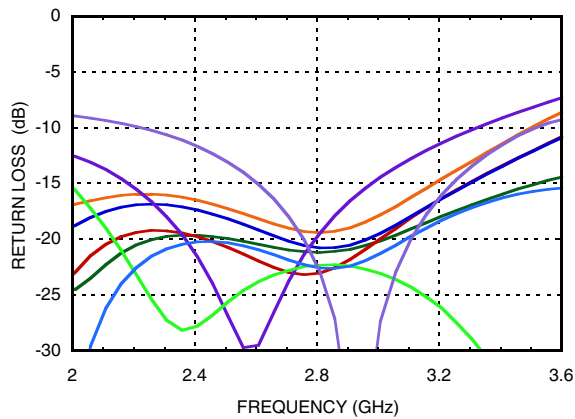

Phase Error, Major States Only

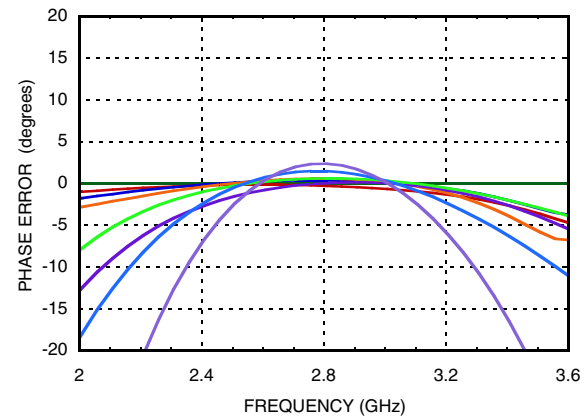

Output Return Loss, Major States Only

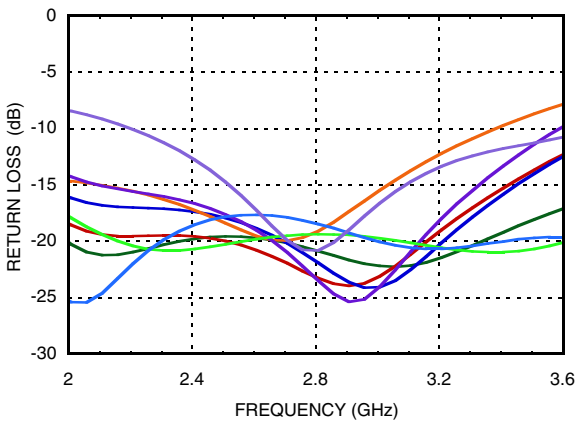

**Relative Phase Shift
 Major States Including All Bits**

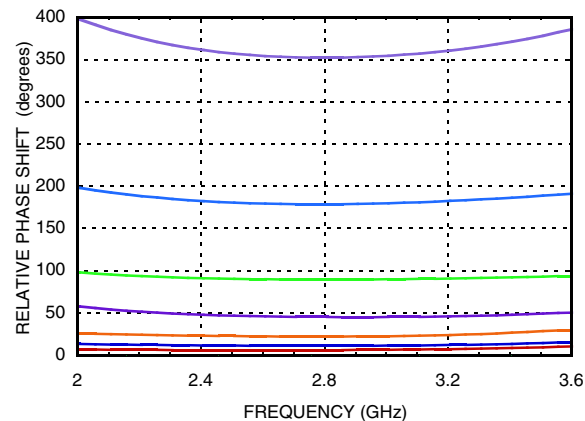



**GaAs MMIC 6-BIT DIGITAL
 PHASE SHIFTER, 2.5 - 3.1 GHz**

**Relative Phase Shift,
 RMS, Average, Max, All States**

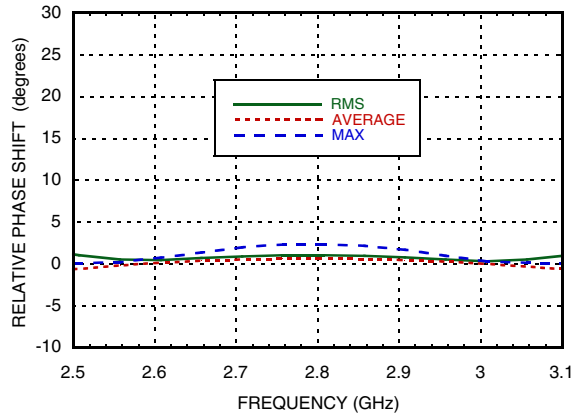

Input IP3, Major States Only

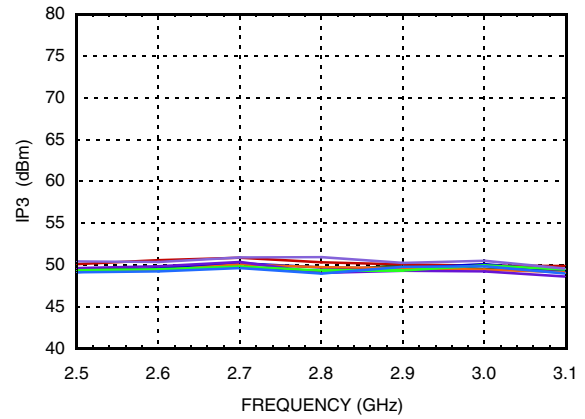

Input IP2, Major States Only

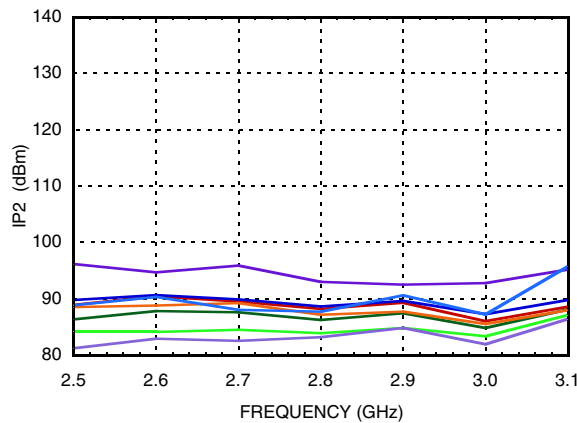

Input P1dB, Major States Only

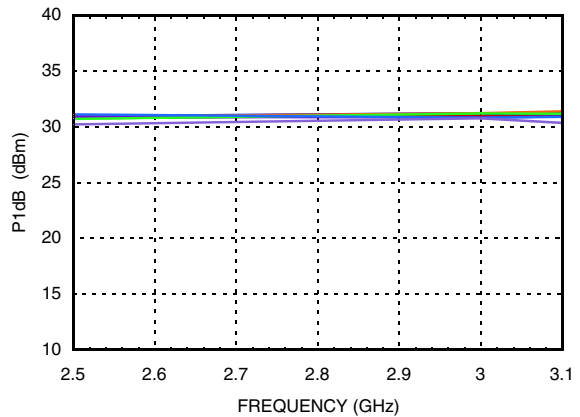

RMS Phase Error vs. Temperature

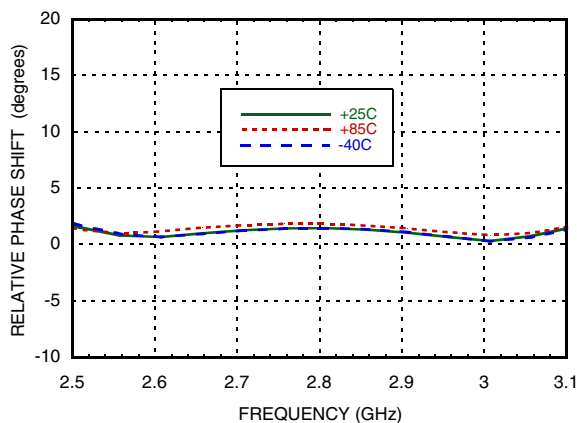

**Insertion Loss vs. Temperature,
 Major States Only**

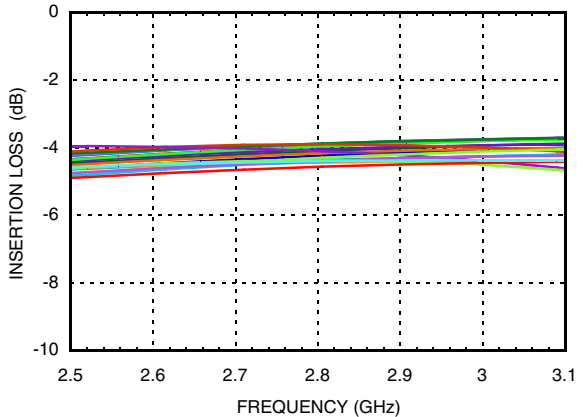



**GaAs MMIC 6-BIT DIGITAL
PHASE SHIFTER, 2.5 - 3.1 GHz**

Phase Error vs. State

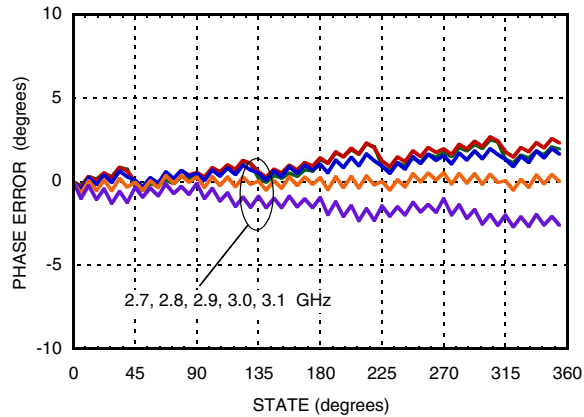

Bias Voltage & Current

Vdd	Idd
5.0	5.3mA
Vss	Iss
-5.0	5.3mA

Control Voltage

State	Bias Condition
Low (0)	0 to 0.2 Vdc
High (1)	Vdd ±0.2 Vdc @ 35 µA Typ.

Absolute Maximum Ratings

Input Power (RFIN)	33 dBm (T= +85 °C)
Bias Voltage Range (Vdd)	-0.2 to +12V
Bias Voltage Range (Vss)	+0.2 to -12V
Channel Temperature (Tc)	150 °C
Thermal Resistance (channel to ground paddle)	128 °C/W
Storage Temperature	-65 to +150 °C
Operating Temperature	-40 to +85 °C
ESD Sensitivity (HBM)	Class1A Passed 250V



**ELECTROSTATIC SENSITIVE DEVICE
OBSERVE HANDLING PRECAUTIONS**

Truth Table

Control Voltage Input						Phase Shift (Degrees) RFIN - RFOUT
Bit 1	Bit 2	Bit 3	Bit 4	Bit 5	Bit 6	
0	0	0	0	0	0	Reference*
1	0	0	0	0	0	5.625
0	1	0	0	0	0	11.25
0	0	1	0	0	0	22.5
0	0	0	1	0	0	45.0
0	0	0	0	1	0	90.0
0	0	0	0	0	1	180.0
1	1	1	1	1	1	354.375

Any combination of the above states will provide a phase shift approximately equal to the sum of the bits selected.
*Reference corresponds to monotonic setting

Outline Drawing

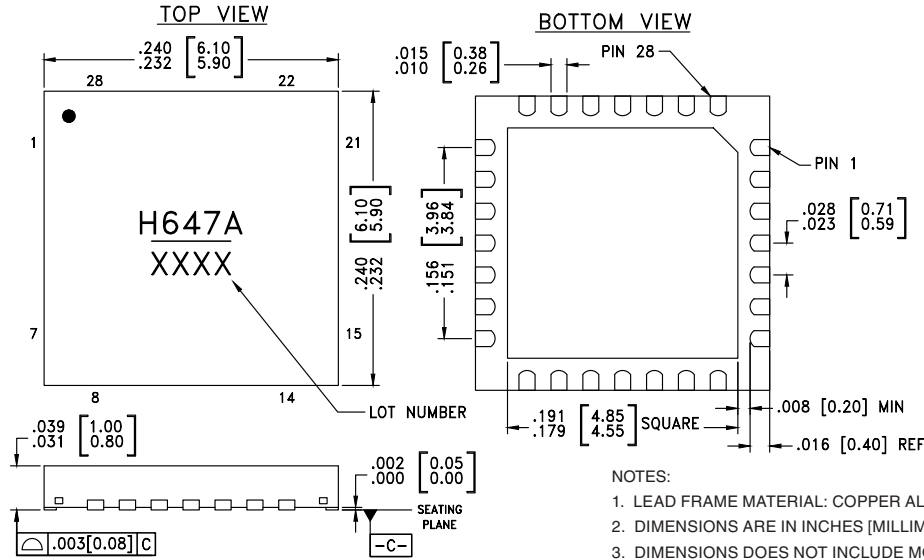

NOTES:

1. LEAD FRAME MATERIAL: COPPER ALLOY
2. DIMENSIONS ARE IN INCHES (MILLIMETERS).
3. DIMENSIONS DOES NOT INCLUDE MOLDFLASH OF 0.15mm PER SIDE
4. DIMENSIONS DOES NOT INCLUDE MOLDFLASH OF 0.25mm PER SIDE
5. ALL GROUND LEADS AND GROUND PADDLE MUST BE SOLDERED TO PCB RF GROUND.
6. CLASSIFIED AS MOISTURE SENSITIVITY LEVEL (MSL) 1.

Package Information

Part Number	Package Body Material	Lead Finish	MSL Rating	Package Marking ^[2]
HMC647ALP6E	RoHS-compliant Low Stress Injection Molded Plastic	100% matte Sn	MSL3 ^[1]	H647A XXXX

[1] Max peak reflow temperature of 260 °C

[2] 4-Digit lot number XXXX

Pin Descriptions

Pin Number	Function	Description	Interface Schematic
1	Vdd	Voltage Supply	
2, 20	GND	These pins and exposed ground paddle must be connected to RF/DC ground.	
3	RFIN	This port is DC coupled and matched to 50 Ohms.	
4 - 18, 21	N/C	No connection required. These pins may be connected to RF/DC ground without affecting performance.	
19	RFOUT	This port is DC coupled and matched to 50 Ohms.	
22 - 24 26 - 28	BIT6, BIT5, BIT4, BIT3, BIT2, BIT1	Control Input. See truth table and control voltage tables.	
25	Vss	Voltage Supply	

Evaluation PCB

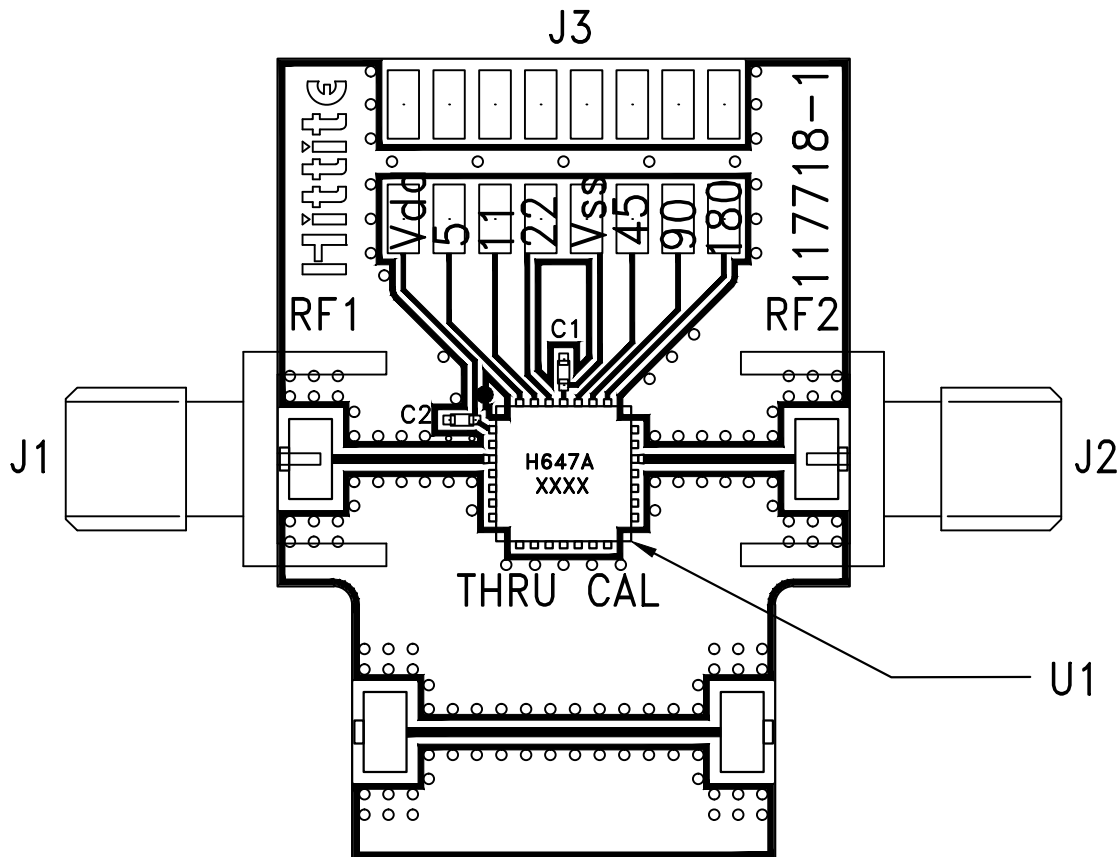

List of Materials for Evaluation EV1HMC647ALP6 [1][3]

Item	Description
J1 - J2	PCB Mount SMA RF Connector
J3	Header 2mm, 16 pins
C1, C2	1000pF, 0402 pkg
U1	HMC647ALP6E 6-Bit Digital Phase Shifter
PCB [2]	117718 Evaluation PCB

[1] Reference this number when ordering complete evaluation PCB

[2] Circuit Board Material: Rogers 4350

[3] Please refer to part's pin description and functional diagram for pin out assignments on evaluation board.

The circuit board used in the final application should use RF circuit design techniques. Signal lines should have 50 ohm impedance while the package ground leads and exposed paddle should be connected directly to the ground plane similar to that shown. A sufficient number of via holes should be used to connect the top and bottom ground planes. The evaluation board should be mounted to an appropriate heat sink. The evaluation circuit board shown is available from Hittite upon request.



Компания «ЭлектроПласт» предлагает заключение долгосрочных отношений при поставках импортных электронных компонентов на взаимовыгодных условиях!

Наши преимущества:

- Оперативные поставки широкого спектра электронных компонентов отечественного и импортного производства напрямую от производителей и с крупнейших мировых складов;
- Поставка более 17-ти миллионов наименований электронных компонентов;
- Поставка сложных, дефицитных, либо снятых с производства позиций;
- Оперативные сроки поставки под заказ (от 5 рабочих дней);
- Экспресс доставка в любую точку России;
- Техническая поддержка проекта, помощь в подборе аналогов, поставка прототипов;
- Система менеджмента качества сертифицирована по Международному стандарту ISO 9001;
- Лицензия ФСБ на осуществление работ с использованием сведений, составляющих государственную тайну;
- Поставка специализированных компонентов (Xilinx, Altera, Analog Devices, Intersil, Interpoint, Microsemi, Aeroflex, Peregrine, Syfer, Eurofarad, Texas Instrument, Miteq, Cobham, E2V, MA-COM, Hittite, Mini-Circuits, General Dynamics и др.);

Помимо этого, одним из направлений компании «ЭлектроПласт» является направление «Источники питания». Мы предлагаем Вам помощь Конструкторского отдела:

- Подбор оптимального решения, техническое обоснование при выборе компонента;
- Подбор аналогов;
- Консультации по применению компонента;
- Поставка образцов и прототипов;
- Техническая поддержка проекта;
- Защита от снятия компонента с производства.



Как с нами связаться

Телефон: 8 (812) 309 58 32 (многоканальный)

Факс: 8 (812) 320-02-42

Электронная почта: org@eplast1.ru

Адрес: 198099, г. Санкт-Петербург, ул. Калинина, дом 2, корпус 4, литера А.