

# General Specifications

## Electrical Capacity (Resistive Load)

**Logic Level:** 0.4VA maximum @ 28V AC/DC maximum  
(Applicable Range 0.1mA ~ 0.1A @ 20mV ~ 28V)  
Note: Find additional explanation of operating range in Supplement section.

## Other Ratings

**Contact Resistance:** 80 milliohms maximum  
**Insulation Resistance:** 500 megohms minimum @ 500V DC  
**Dielectric Strength:** 500V AC minimum for 1 minute minimum  
**Mechanical Life:** 50,000 operations minimum  
**Electrical Life:** 50,000 operations minimum  
**Nominal Operating Force:** 2.0N  
**Travel:** Pretravel: .024" (0.6mm); Overtravel: .019" (0.5mm); Total Travel: .043" (1.1mm)

## Materials & Finishes

**Actuator:** Polyphenylene sulfide (UL94V-0)  
**Case:** Polyphenylene sulfide (UL94V-0)  
**Sealing Rings:** Nitrile butadiene rubber  
**Movable Contacts:** Phosphor bronze with gold plating  
**Stationary Contacts:** Phosphor bronze with gold plating  
**Base:** Polyphenylene sulfide (UL94V-0)  
**Terminals:** Phosphor bronze with gold plating

## Environmental Data

**Operating Temperature Range:** -30°C through +85°C (-22°F through +185°F)  
**Humidity:** 90 ~ 95% humidity for 96 hours @ 40°C (104°F)  
**Vibration:** 10 ~ 500Hz with peak-to-peak amplitude of 1.5mm traversing the frequency range & returning in 1 minute; 3 right angled directions for 2 hours  
**Shock:** 50G (490m/s<sup>2</sup>) acceleration (tested in 6 right angled directions, with 5 shocks in each direction)

## Installation

**Mounting:** It is recommended that the body of models for upright mounting without bracket be fastened to a panel or similar support for protection of solder joints from mechanical stress.  
**Coplanarity:** See specifications in Terms & Acronyms in Supplement section.

## Processing

**Soldering:** Reflow Soldering Recommended. See Profile B in Supplement section.  
Manual Soldering: See Profile B in Supplement section.  
**Cleaning:** Automated cleaning. See Cleaning specifications in Supplement section.

## Standards & Certifications

**Flammability Standard:** UL94V-0 actuator, case & base  
The G3B Series pushbuttons have not been tested for UL recognition or CSA certification. These switches are designed for use in a low-voltage, low-current, logic-level circuit. When used as intended in a logic-level circuit, the results do not produce hazardous energy.

# Distinctive Characteristics

Ultra-miniature size allows high density mounting, and extremely light weight of 0.6 gram makes these switches ideal for handheld equipment.

Tape-reel and stick-tube packaging allow rapid automated placement of surface mount devices. Tape-reel packaging meets EIA-481-D Standard.

Heat resistant resin used for housing, base, and plunger allows vapor phase and infrared convection reflow soldering.

Combination of design features achieves total seal and allows automated processing techniques, including flux cleaning procedures: one-piece bushing and housing, rubber seals surrounding actuator and base, epoxy at joint of case and base, and molded-in, epoxy-sealed terminals.

Award-winning STC contact mechanism with benefits unavailable in conventional mechanisms: smoother, positive detent actuation, increased contact stability and unparalleled logic-level reliability. (Additional STC details in Terms & Acronyms; see Supplement section.)

Gull-wing terminals provide mechanical stability during soldering and simplified solder joint inspection.

Coplanarity: all considered surfaces must lie between two parallel planes that area maximum distance apart of .0059" (0.15mm). (Additional coplanarity details in Terms and Acronyms in the Supplement section.)

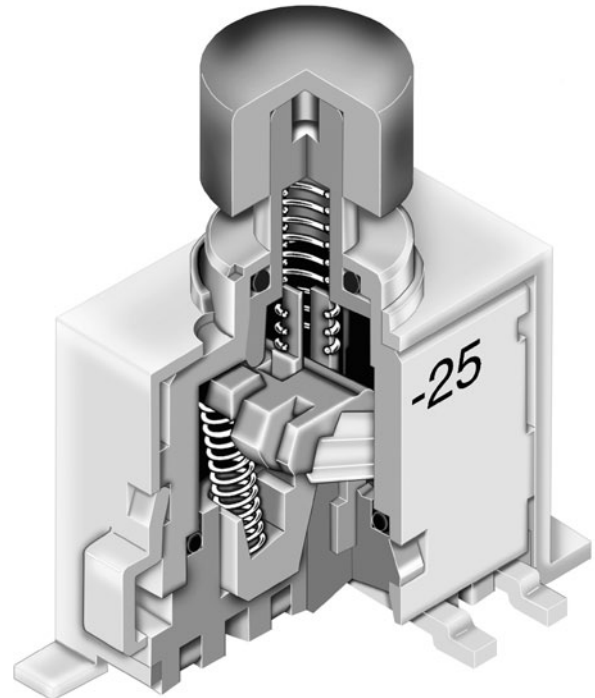

Actual Size



Toggles

Rockers

 Pushbuttons

Illuminated PB

Programmable

Keylocks

Rotaries

Slides

Tactiles

Tilt

Touch

Indicators

Accessories

Supplement

### TYPICAL SWITCH ORDERING EXAMPLE

**G3B** **1** **5** **A** **B** — — —

Poles	
1	SPDT
2	DPDT

Plunger	
A	.130" (3.3mm) Long

Terminals	
P	Gull Wing for Upright Mount
B	Gull Wing for Upright with Bracket
H	Gull Wing for Right Angle

Colors	
A	Black
B	White
C	Red

Circuits		
5	ON	(ON)
( ) = Momentary		

Packaging	
No Code	Partitioned Tray for Upright & Right Angle - Any Quantity
R	Tape-Reel for Right Angle Only 500 Pieces/Reel
S	Stick-Tube for Upright Mount 50 Pieces/Stick

Optional Caps	
X	Slip-on Cap .157" (4.0mm) Diameter (For installation after processing only)
Y	Process Compatible Cap .157" (4.0mm) Diameter (Combines with R or S packaging only)

Packaging details at end of G3B Series

### DESCRIPTION FOR TYPICAL ORDERING EXAMPLE

#### G3B15AB

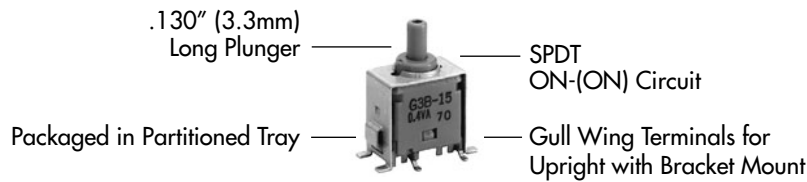

### POLES & CIRCUITS

Pole	Model	Plunger Position ( ) = Momentary		Connected Terminals		Throw & Schematics
		Normal	Down	Normal	Down	
SP	G3B15	ON 	(ON) 	5-6 	5-4 	SPDT 
DP	G3B25	ON 	(ON) 	5-6 2-3 	5-4 2-1 	DPDT 

Note: Terminal numbers are not actually on the switch.

## PLUNGER & OPTIONAL CAPS

**A** .130" (3.3mm)  
Long Plunger

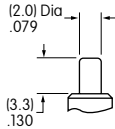

**X** AT4063 Slip-on Cap  
.157" (4.0mm) Diameter

Available with bulk packaging only. Cap must be installed after processing.

Material: Polyamide  
Finish: Glossy



Actual Size

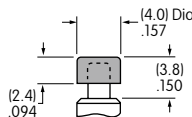

**Y** Process Compatible Cap  
.157" (4.0mm) Diameter

Factory assembled. Available with tape-reel or stick-tube packaging only.

**Caution:** Pulling force specification for this cap is not warranted after reflow processing.

Material: Polyamide  
Finish: Glossy

Cap Colors Available:



Black



White



Red

## TYPICAL SWITCH DIMENSIONS

### Single & Double Pole

### Upright Mounting

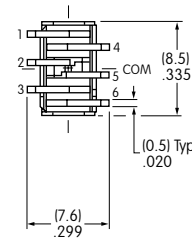
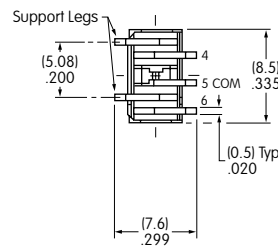
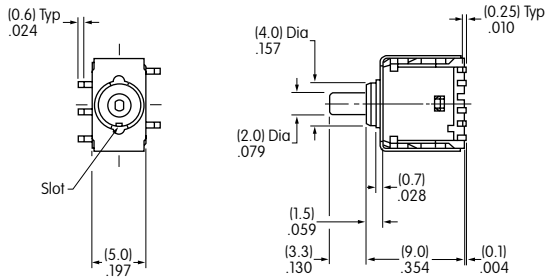

G3B25AP

### Single & Double Pole

### Upright Mounting with Bracket

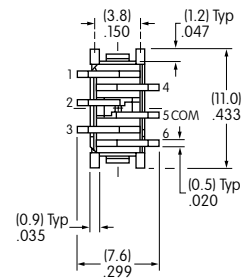
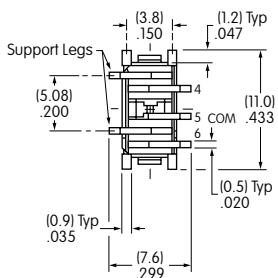
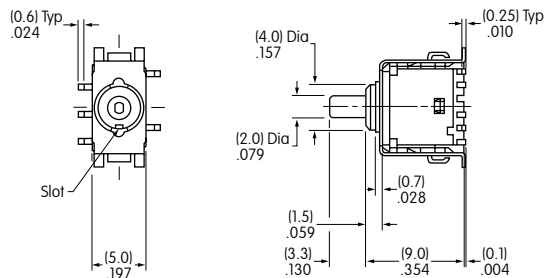

G3B15AB

### Right Angle Mounting

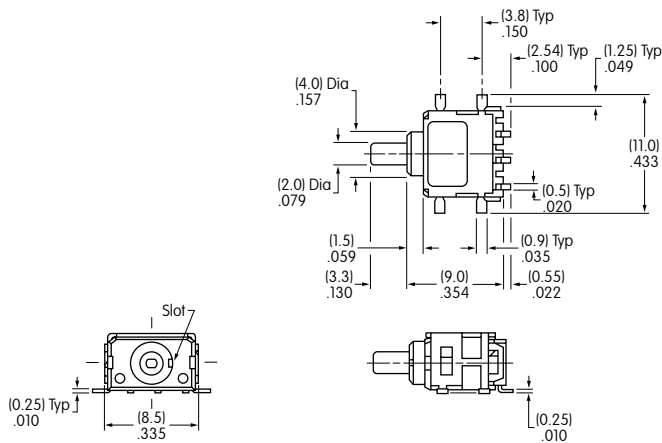

### Single Pole

### Double Pole

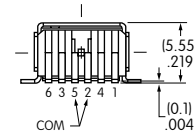
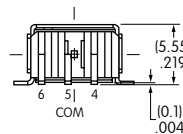

G3B15AH

Toggles

Rockers

Pushbuttons

Illuminated PB

Keylocks

Rotaries

Slides

Tactiles

Tilt

Touch

Indicators

Accessories

Supplement

### Pad Layouts for Surface Mount Terminals

#### Single Pole Double Throw

#### Upright Mounting

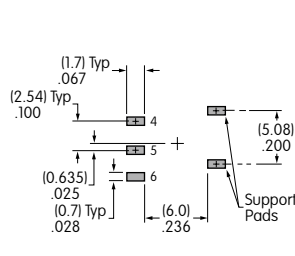

#### Upright Mounting with Bracket

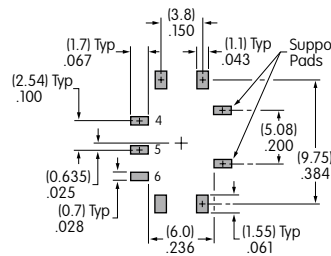

#### Right Angle Mounting

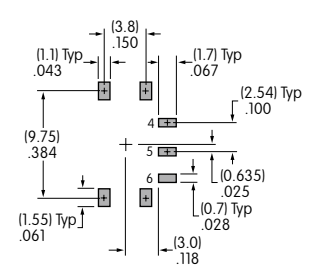

#### Double Pole Double Throw

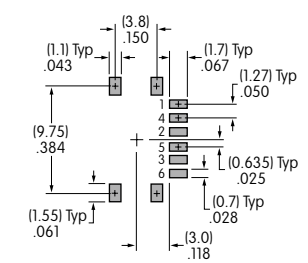
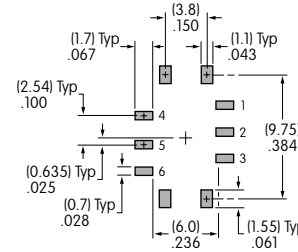
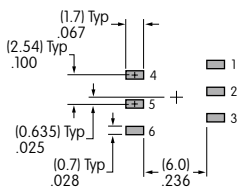

## PACKAGING

**No Code**

### Partitioned Tray for Upright & Right Angle

Any quantity

If the G3 upright models are ordered in less than 50-piece increments or the right angle models in less than 500-piece increments, the switches are packaged in a partitioned tray. No code is required.



**R**

### Tape-Reel for Right Angle

500 pieces per reel

Switches must be ordered in 500-piece increments when tape-reel packaging is selected.

This packaging meets EIA-481-D Standard for "16mm and 24mm Embossed Carrier Taping of Surface Mount Components for Automatic Handling."



PACKAGING (CONTINUED)

**S** Stick-Tube for Upright Mount

50 pieces per stick

Switches must be ordered in 50-piece increments when stick-tube packaging is selected.

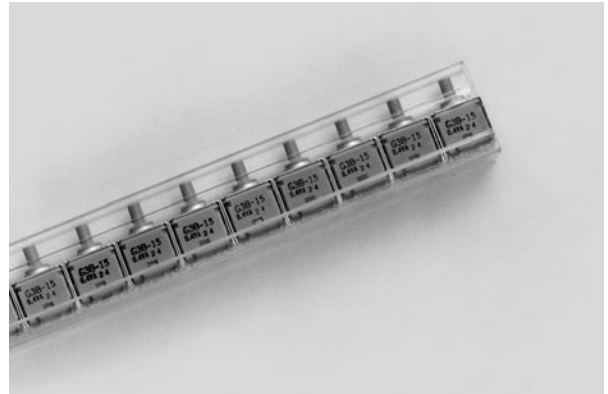

**Tape-Reel Packaging for Right Angle Mount**

Each tape-reel of 550 pockets contains 500 switches.

Minimum Leader Length: 7.87" (200mm) Minimum Trailer Length: 1.97" (50mm)

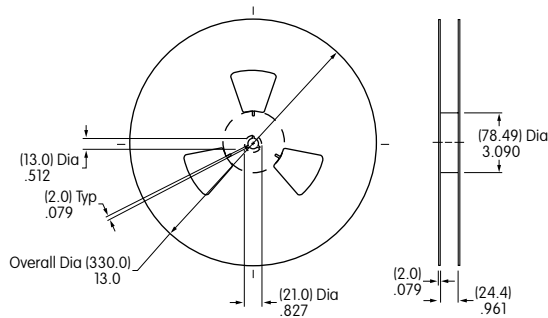

Reel Dimensions

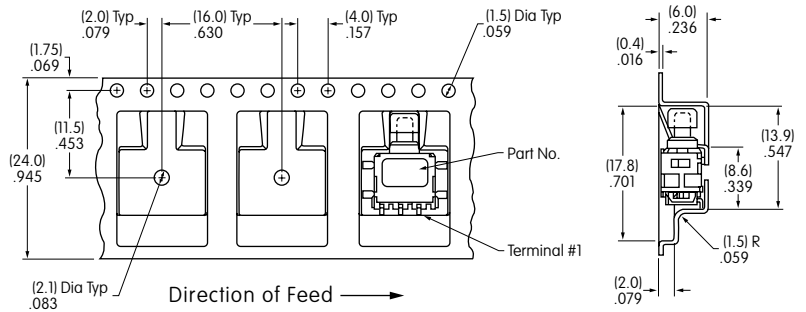

Tape Dimensions

**Stick-Tube Packaging for Upright Mount**

Each stick-tube contains 50 switches.

L = Length

G3B Upright (code P)  
18.31" (465mm)

G3B Upright with Bracket (code B)  
21.26" (540mm)

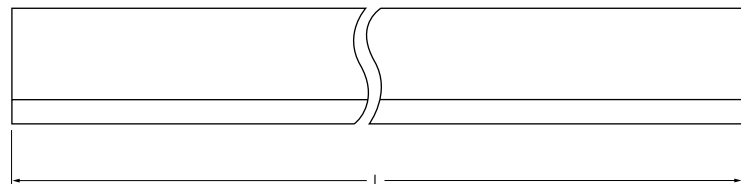
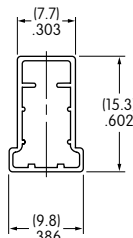

Stick-Tube Dimensions

- Toggles
- Rockers
- Pushbuttons**
- Illuminated PB
- Programmable
- Keylocks
- Rotaries
- Slides
- Tactiles
- Tilt
- Touch
- Indicators
- Accessories
- Supplement



Компания «ЭлектроПласт» предлагает заключение долгосрочных отношений при поставках импортных электронных компонентов на взаимовыгодных условиях!

Наши преимущества:

- Оперативные поставки широкого спектра электронных компонентов отечественного и импортного производства напрямую от производителей и с крупнейших мировых складов;
- Поставка более 17-ти миллионов наименований электронных компонентов;
- Поставка сложных, дефицитных, либо снятых с производства позиций;
- Оперативные сроки поставки под заказ (от 5 рабочих дней);
- Экспресс доставка в любую точку России;
- Техническая поддержка проекта, помощь в подборе аналогов, поставка прототипов;
- Система менеджмента качества сертифицирована по Международному стандарту ISO 9001;
- Лицензия ФСБ на осуществление работ с использованием сведений, составляющих государственную тайну;
- Поставка специализированных компонентов (Xilinx, Altera, Analog Devices, Intersil, Interpoint, Microsemi, Aeroflex, Peregrine, Syfer, Eurofarad, Texas Instrument, Miteq, Cobham, E2V, MA-COM, Hittite, Mini-Circuits, General Dynamics и др.);

Помимо этого, одним из направлений компании «ЭлектроПласт» является направление «Источники питания». Мы предлагаем Вам помощь Конструкторского отдела:

- Подбор оптимального решения, техническое обоснование при выборе компонента;
- Подбор аналогов;
- Консультации по применению компонента;
- Поставка образцов и прототипов;
- Техническая поддержка проекта;
- Защита от снятия компонента с производства.



#### Как с нами связаться

**Телефон:** 8 (812) 309 58 32 (многоканальный)

**Факс:** 8 (812) 320-02-42

**Электронная почта:** [org@eplast1.ru](mailto:org@eplast1.ru)

**Адрес:** 198099, г. Санкт-Петербург, ул. Калинина, дом 2, корпус 4, литера А.