

SMA

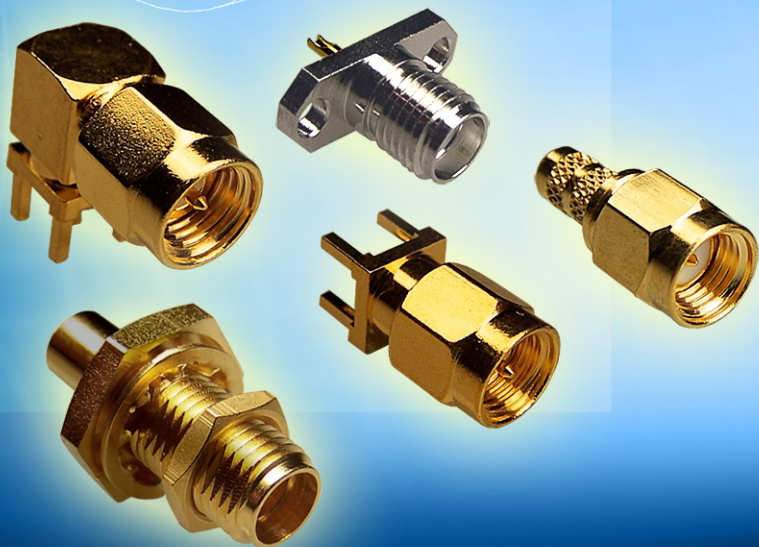

SMA Connectors

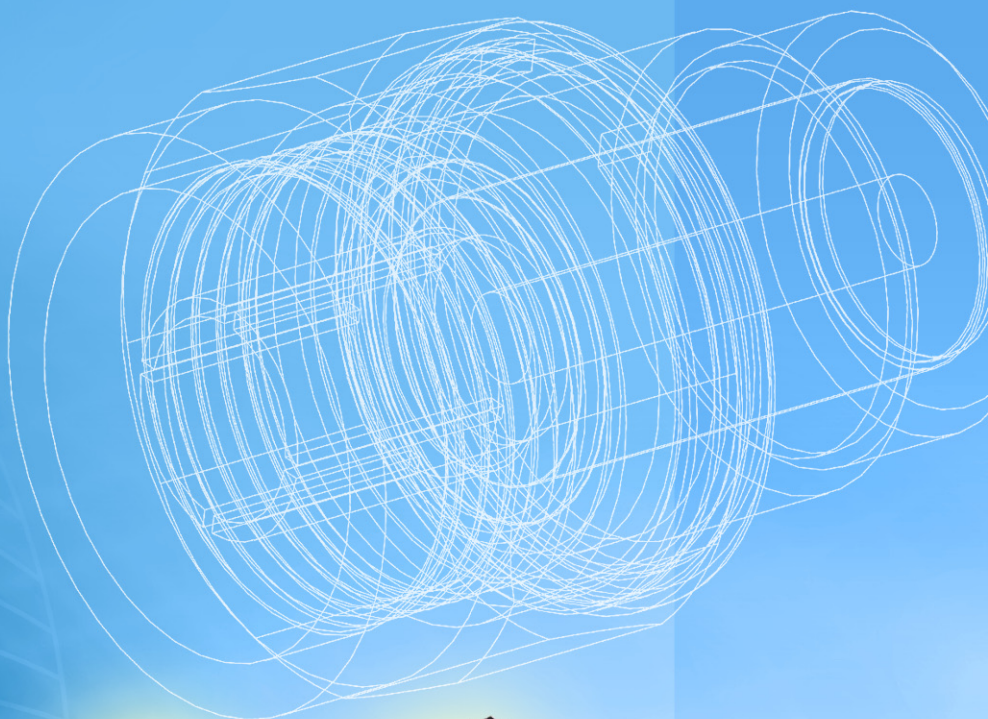

SMA Connectors

Description

SMA is an acronym for SubMiniature version A and was developed in the 1960's. It uses a threaded interface. 50 Ω SMA connectors are semi-precision, subminiature units that provide excellent electrical performance from DC to 18 GHz. These high-performance connectors are compact in size and mechanically have outstanding durability.

For phase array radar, test equipment, ILS landing systems and other instrumentation using phase matching techniques, these SMA connectors for semi-rigid coaxial cables and the SMA Plug-to-Jack adapter offer a precise and simple means of phase adjustment for microwave devices. Built in accordance with MIL-C-39012 and CECC 22110/111, SMA connectors can be mated with all connectors that meet these interface specifications, regardless of manufacturer.

SMA is available both in Standard and Reverse Polarity. Reverse polarity is a keying system accomplished with a reverse interface, and ensures that reverse polarity interface connectors do not mate with standard interface connectors. Amphenol accomplishes this by inserting female contacts into plugs and male contacts into jacks.

Features/Benefits

- Broadband performance DC to 18 GHz with low reflection stainless steel construction and 1/4-36 threaded coupling.
- Brass SMA available in nickel or gold plating which provides approximately 30% cost reduction with 100 mating cycles.
- Available for .085" and .141" diameter semi-rigid cables and all the standard flexible cables including double shielded RG-316.
- Phase Adjustable SMA connectors provide ease of mechanical screw adjustments.

Applications

- Base Stations
- Cable Assemblies
- Instrumentation
- Mil/Aero
- Process Controls
- PC/LAN
- Telecom

Stainless Steel SMA Specifications

Electrical

Impedance	50 Ω
Frequency range	DC - 18 GHz (semi-rigid cable) DC - 12.4 GHz (flexible cable)
RF-leakage	100 dB-f minimum @ 3 GHz (semi-rigid cable) 60 dB minimum @ 3 GHz (flexible cable)
Voltage rating (at sea level)	≤ 500 Vrms (semi-rigid, depending on cable) ≤ 335 Vrms (flexible, depending on cable)
Contact resistance	center contact: ≤ 2 mΩ outer contact: ≤ 2 mΩ braid to body: ≤ 0.5 mΩ
Insulation resistance	5,000 MΩ minimum
Insertion loss maximum	dB maximum = .03 √ f(GHz)
Dielectric withstanding voltage	1,500 Vrms (semi-rigid cable, at sea level) 1,000 Vrms (flexible cable, at sea level)

Mechanical

Mating	.250-36 threaded coupling
Coupling torque	15 in-lbs (22 / 170 N-cm) max, recom. 7 / 10 in-lbs (80 / 110 N-cm)
Coupling nut retention force	100 in-lbs (300 N-cm) min.
Braid/Jacket cable affixment	Crimp and solder types
Center conductor cable affixment	Solder, unless noted otherwise
Captivated contacts	All types, unless noted otherwise
Durability (matings)	500 cycles minimum

Environmental

Temperature range	-65°C to +165°C
Weatherproof	crimp: w/ heat shrink tubing, solder: w/ gasket
Thermal shock	MIL-STD-202, method 107, cond. B
Moisture resistance	MIL-STD-202, method 106 (except step 7b)
Corrosion	MIL-STD-202, method 101, cond. B
Vibration	MIL-STD-202, method 204, cond. D
Mechanical shock	MIL-STD-202, method 213, cond. 1
Altitude	MIL-STD-202, method 105, cond. C (n/a 70,000 ft)

Note: These characteristics are typical but may not apply to all connectors.

Stainless Steel SMA Specifications (continued)

Material

Center contact	Beryllium copper, gold plated
Crimp ferrule	Copper or brass
Other metal parts	Non-magnetic stainless steel (except as noted)
Plated	Gold or nickel
Insulator	PTFE (ASTM D1457)
Gasket	Silicone rubber (MIL-R-5847 and ZZ-R-765)

Military

MIL-C-39012	where applicable
MIL-C-83517 SMA	where applicable

Plug

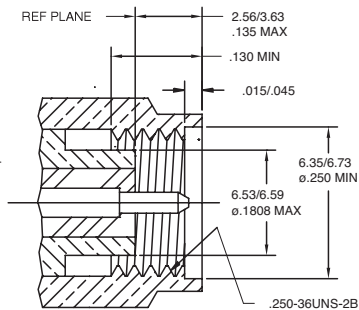

Jack

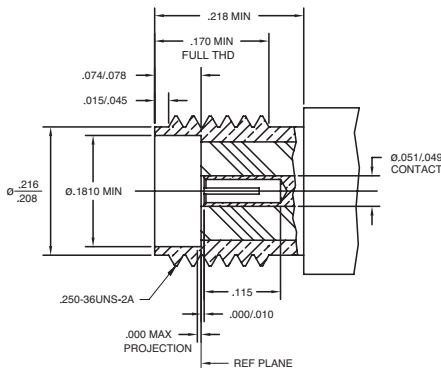

Brass SMA Specifications

Electrical

Impedance	50 Ω
Frequency range	DC - 18 GHz (semi-rigid cable) DC - 12.4 GHz (flexible cable)
RF-leakage	100 dB-f minimum @ 3 GHz (semi-rigid cable) 60 dB minimum @ 3 GHz (flexible cable)
Voltage rating (at sea level)	≤ 500 Vrms (semi-rigid, depending on cable) ≤ 335 Vrms (flexible, depending on cable)
Contact resistance	center contact: ≤ 2 mΩ outer contact: ≤ 2 mΩ braid to body: ≤ 0.5 mΩ
Insulation resistance	5,000 MΩ minimum
Insertion loss maximum	dB maximum = .06 √ f(GHz)
Dielectric withstanding voltage	1,500 Vrms (semi-rigid cable, at sea level) 1,000 Vrms (flexible cable, at sea level)

Mechanical

Mating	.250-36 threaded coupling
Coupling torque, min./max.	max. = 5.2 in-lbs (60 N-cm), recommended = 4 in-lbs (45 N-cm)
Coupling nut retention force	100 in-lbs (300 N-cm) min.
Braid/Jacket cable affixment	Crimp and solder types
Center conductor cable affixment	Solder, unless noted otherwise
Captivated contacts	All types, unless noted otherwise
Durability (matings)	100 cycles minimum

Environmental

Temperature range	-65°C to +165°C
Weatherproof	crimp: w/ heat shrink tubing, solder: w/ gasket
Thermal shock	MIL-STD-202, method 107, cond. B
Moisture resistance	MIL-STD-202, method 106 (except step 7b)
Corrosion	MIL-STD-202, method 101, cond. B
Vibration	MIL-STD-202, method 204, cond. D
Mechanical shock	MIL-STD-202, method 213, cond. 1
Altitude	MIL-STD-202, method 105, cond. C (n/a 70,000 ft)

Material

Male contact	Brass, gold plated
Female contact	Beryllium copper, gold plated
Crimp ferrule	Copper or brass
Other metal parts	Brass (except as noted), gold or nickel plated
Insulator	PTFE (ASTM D1457)
Gasket	Silicone rubber (MIL-R-5847 and ZZ-R-765)

Military

MIL-C-39012	where applicable
MIL-C-83517 SMA	where applicable

Note: These characteristics are typical but may not apply to all connectors.

Brass SMA Specifications (continued)

Plug

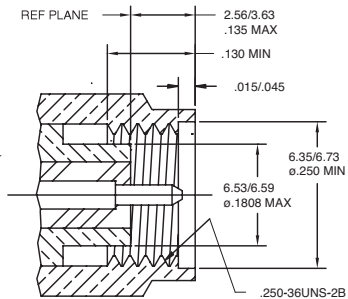

Jack

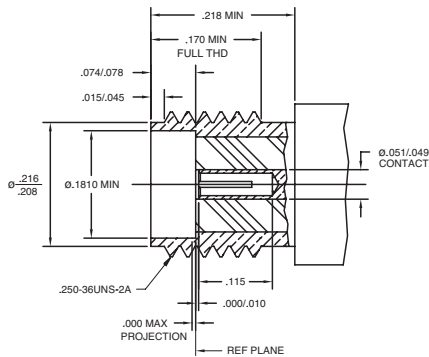

Reverse Polarity SMA Specifications

Electrical

Impedance	50 Ω
Frequency range	DC - 18 GHz (semi-rigid cable) DC - 12.4 GHz (flexible cable)
RF-leakage	100 dB-f minimum @ 3 GHz (semi-rigid cable) 60 dB minimum @ 3 GHz (flexible cable)
Voltage rating (at sea level)	≤ 500 Vrms (semi-rigid, depending on cable) ≤ 335 Vrms (flexible, depending on cable)
Contact resistance	center contact: ≤ 2 mΩ outer contact: ≤ 2 mΩ braid to body: ≤ 0.5 mΩ
Insulation resistance	5,000 MΩ minimum
Dielectric withstanding voltage	1,500 Vrms (semi-rigid cable, at sea level) 1,000 Vrms (flexible cable, at sea level)

Mechanical

Mating	.250-36 threaded coupling
Coupling nut retention force	100 in-lbs (300 N-cm) min.
Braid/Jacket cable affixment	Crimp and solder types
Center conductor cable affixment	Solder, unless noted otherwise
Captivated contacts	All types, unless noted otherwise
Durability (matings)	100 cycles min. (brass), 500 cycles min. (stainless steel)

Environmental

Temperature range	-65°C to +165°C
Weatherproof	crimp: w/ heat shrink tubing, solder: w/ gasket
Thermal shock	MIL-STD-202, method 107, cond. B
Moisture resistance	MIL-STD-202, method 106 (except step 7b)
Corrosion	MIL-STD-202, method 101, cond. B
Vibration	MIL-STD-202, method 204, cond. D
Mechanical shock	MIL-STD-202, method 213, cond. 1
Altitude	MIL-STD-202, method 105, cond. C (n/a 70,000 ft)

Material

Center contact	Beryllium copper, gold plated
Crimp ferrule	Copper or brass
Other metal parts	Non-magnetic stainless steel or brass, gold, silver or nickel plated
Insulator	PTFE (ASTM D1457)
Gasket	Silicone rubber (MIL-R-5847 and ZZ-R-765)

Military

MIL-C-39012

MIL-C-83517 SMA

Note: These characteristics are typical but may not apply to all connectors.

Plug

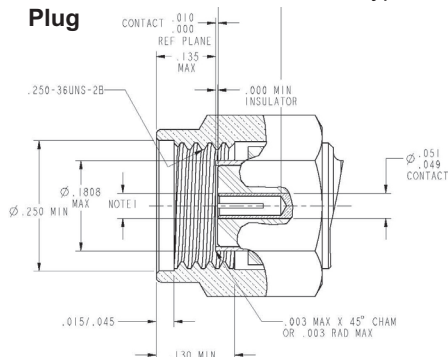

where applicable

where applicable

where applicable

Jack

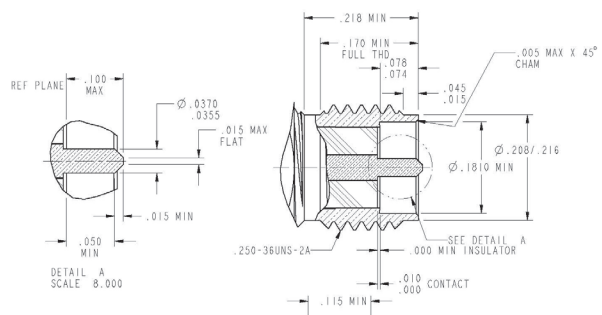

Cable Connectors

Straight Plugs for Flexible Cable

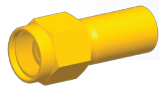

Cable Group	Part Number	Body Material	Plating		Termination	
			Body	Contact	Body	Contact
B	901-9601-3	Stainless Steel	Gold	Gold	Crimp	Solder
B	901-9601-3SF	Stainless Steel	Passivated	Gold	Crimp	Solder
B	901-9501-3	Stainless Steel	Gold	Gold	Crimp	Solder
B	901-128-11 (QPL)	Stainless Steel	Gold	Gold	Clamp	Solder
B	901-9511-3	Stainless Steel	Gold	Gold	Crimp	Solder
B	901-9511-3SF	Stainless Steel	Passivated	Gold	Crimp	Solder
B	901-9511-12SF	Stainless Steel	Passivated	Gold	Crimp	Solder
B	901-9511-3SFC	Stainless Steel	Passivated	Gold	Solder	Crimp
B	901-9511-12SFC	Stainless Steel	Passivated	Gold	Solder	Crimp
B	901-155-12 (QPL)	Stainless Steel	Gold	Gold	Crimp	Solder
B	901-155-16 (QPL)	Stainless Steel	Gold	Gold	Crimp	Solder
B2	901-9877-RFX	Brass	Nickel	Gold	Crimp	Solder
B	901-9916	Brass	Gold	Gold	Crimp	Solder
C	901-103	Stainless Steel	Gold	Gold	Clamp	Solder
C	901-103-11 (QPL)	Stainless Steel	Gold	Gold	Clamp	Solder
C	901-9511-2	Stainless Steel	Gold	Gold	Crimp	Solder
C	901-9511-2SF	Stainless Steel	Gold	Gold	Crimp	Solder
C	901-9870	Brass	Gold	Gold	Crimp	Solder
C	901-9876-RFX	Brass	Nickel	Gold	Crimp	Solder
C	901-9871	Brass	Gold	Gold	Crimp	Solder
C1	901-9601-1SF	Stainless Steel	Passivated	Gold	Crimp	Solder
C1	901-9511-1	Stainless Steel	Gold	Gold	Crimp	Solder
C1	901-9511-1SF	Stainless Steel	Passivated	Gold	Crimp	Crimp
C1	901-9511-1SFC	Stainless Steel	Passivated	Gold	Crimp	Crimp
C1	901-101-15 (QPL)	Stainless Steel	Gold	Gold	Crimp	Crimp
C2	901-10010-RFX	Brass	Gold	Gold	Crimp	Solder
C2	901-10012	Stainless Steel	Passivated	Gold	Crimp	Solder
G2	901-10009-RFX	Brass	Gold	Gold	Crimp	Solder
G2	901-10011	Stainless Steel	Passivated	Gold	Crimp	Solder

Straight Plugs for Semi-Rigid Cable

Cable Group	Part Number	Body Material	Plating		Termination
			Body	Contact	Body & Contact
L	901-9201-1A	Stainless Steel	Gold	Gold	Solder
L	901-9201-1ASF	Stainless Steel	Gold	Gold	Solder
L	901-9808	Stainless Steel	Gold	Gold	Solder
L	901-9808-1	Stainless Steel	Gold	Gold	Solder
L	901-9808-2	Stainless Steel	Gold	Gold	Solder
L	901-9868-RFX	Brass	Gold	Gold	Solder
L2	901-9201-2A	Stainless Steel	Gold	Gold	Solder
L2	901-9201-2ASF	Stainless Steel	Gold	Gold	Solder
L2	901-9723	Stainless Steel	Gold	Gold	Solder
L2	901-9723-10	Stainless Steel	Gold	Gold	Solder
L2	901-9805-HP	Stainless Steel	Gold	Gold	Solder
L2	901-9867-RFX	Brass	Gold	Gold	Solder

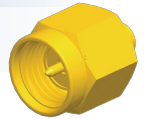

Angle Plugs for Flexible Cable

Cable Group	Part Number	Body Material	Plating		Termination	
			Body	Contact	Body	Contact
B	901-368-12 (QPL)	Stainless Steel	Gold	Gold	Solder	Solder
B	901-9531-3	Stainless Steel	Gold	Gold	Crimp	Solder
B	901-9521-3	Stainless Steel	Gold	Gold	Crimp	Solder
B	901-9531-3SF	Stainless Steel	Passivated	Gold	Crimp	Crimp
B	901-9872	Brass	Gold	Gold	Crimp	Solder
B	901-9881-RFX	Brass	Nickel	Gold	Crimp	Solder
B2	901-9531-12	Stainless Steel	Gold	Gold	Crimp	Crimp
B2	901-9531-12SF	Stainless Steel	Passivated	Gold	Crimp	Solder
C	901-9531-2	Stainless Steel	Gold	Gold	Crimp	Solder
C	901-9531-2SF	Stainless Steel	Passivated	Gold	Solder	Crimp
C	901-9873	Brass	Gold	Gold	Crimp	Solder
C	901-9880-RFX	Brass	Nickel	Gold	Crimp	Solder
C1	901-148-15 (QPL)	Stainless Steel	Gold	Gold	Solder	Solder
C1	901-9531-1	Stainless Steel	Gold	Gold	Crimp	Solder
C1	901-9531-1SF	Stainless Steel	Passivated	Gold	Crimp	Solder
C1	901-9874	Brass	Gold	Gold	Crimp	Solder
G2	901-10014	Stainless Steel	Passivated	Gold	Solder	Crimp



Cable Connectors (continued)

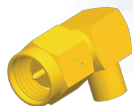

Angle Plugs for Semi-Rigid Cable

Cable			Plating		Termination	
Group	Part Number	Body Material	Body	Contact	Body & Contact	
L	901-9221-1A	Stainless Steel	Gold	Gold	Solder	
L	901-9221-1ASF	Stainless Steel	Gold	Gold	Solder	
L2	901-9221-2A	Stainless Steel	Gold	Gold	Solder	
L2	901-9221-2ASF	Stainless Steel	Gold	Gold	Solder	



Straight Jacks

Cable			Plating		Termination	
Group	Part Number	Body Material	Body	Contact	Body	Contact
B	901-9602-3	Stainless Steel	Gold	Gold	Crimp	Solder
B	901-9602-3SF	Stainless Steel	Passivated	Gold	Crimp	Solder
B2	901-9602-12SF	Stainless Steel	Passivated	Gold	Crimp	Solder
C1	901-9602-1	Stainless Steel	Gold	Gold	Crimp	Solder
C1	901-9602-1SF	Stainless Steel	Passivated	Gold	Crimp	Solder
L	901-9202-1A	Stainless Steel	Gold	Gold	Solder	Solder
L	901-9704	Stainless Steel	Gold	Gold	Solder	Captivated
L2	901-9202-2A	Stainless Steel	Gold	Gold	Solder	Solder



Bulkhead Jacks

Cable			Plating		Termination	
Group	Part Number	Body Material	Body	Contact	Body	Contact
B	901-9610-3	Stainless Steel	Gold	Gold	Crimp	Solder
B	901-9610-3SF	Stainless Steel	Passivated	Gold	Crimp	Solder
B	901-10021-3SF	Stainless Steel	Passivated	Gold	Crimp	Solder
B	901-9875	Brass	Gold	Gold	Crimp	Solder
B	901-9879-RFX	Brass	Nickel	Gold	Crimp	Solder
B	901-10013-RFX	Brass	Nickel	Gold	Crimp	Solder
B2	901-9610-12SF	Stainless Steel	Passivated	Gold	Crimp	Solder
B2	901-10021-12SF	Stainless Steel	Passivated	Gold	Crimp	Solder
C1	901-9610-1SF	Stainless Steel	Passivated	Gold	Crimp	Solder
C1	901-10021-1SF	Stainless Steel	Passivated	Gold	Crimp	Solder
G2	901-10015	Stainless Steel	Passivated	Gold	Crimp	Solder
L	901-9210-1	Stainless Steel	Gold	Gold	Solder	Solder
L2	901-9210-2	Stainless Steel	Gold	Gold	Solder	Solder

Receptacles

Straight Bulkhead Jacks

Part Number	Body Material	Plating		Terminal Type	Description
		Body	Contact		
901-9911	Stainless Steel	Passivated	Gold	Blunt Post	Front Mount, .050 Pin
901-9211	Stainless Steel	Gold	Gold	Solder Cup	Rear Mount/Hex Flange
901-9220	Stainless Steel	Gold	Gold	Blunt Post	Front or Rear Mount
901-9841	Stainless Steel	Gold	Gold	Post	Front Mount
901-9856	Stainless Steel	Passivated	Gold	Slot	Press Fit
901-9023	Stainless Steel	Passivated	Gold	Socket	Front or Rear Mount (launcher)

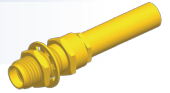

Straight Panel Plugs: 4-Hole Flange

Part Number	Body Material	Plating		Terminal Type
		Body	Contact	
901-9214-CC	Stainless Steel	Gold	Gold	Blunt Post/.158(4.0) Long
901-9767	Stainless Steel	Passivated	Gold	Blunt Post/.115(2.9) Long

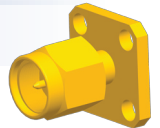

Straight Panel Jacks: 4-Hole Flange

Part Number	Body Material	Plating		Terminal Type
		Body	Contact	
901-9215	Stainless Steel	Gold	Gold	Solder Cup .200" (5.1mm) Long
901-9758	Stainless Steel	Passivated	Gold	Blunt Post .115" (2.9mm) Long
901-9204-CCSF	Stainless Steel	Passivated	Gold	Blunt Post .205" dielectric + .060" center conductor behind flange
901-9839	Stainless Steel	Passivated	Gold	Blunt Post .06" dielectric + .120" center conductor behind flange
901-9789	Stainless Steel	Passivated	Gold	Blunt Post .590" dielectric + .117" center conductor behind flange
901-9804-1	Stainless Steel	Passivated	Gold	Blunt Post, Solder Dipped .010 dia

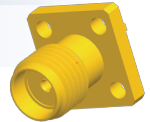

Straight Panel Jacks: 2-Hole Flange

Part Number	Body Material	Plating		Terminal Type
		Body	Contact	
901-9244-1	Stainless Steel	Gold	Gold	Slot .025" (0.6mm) wide
901-9244-1SF	Stainless Steel	Passivated	Gold	Slot .025" (0.6mm) wide
901-9814	Stainless Steel	Passivated	Gold	Socket (Flush)
901-9770	Stainless Steel	Passivated	Gold	Socket (Extended Dielectric)

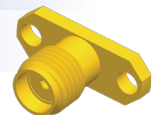

Receptacles (continued)

Panel Jacks

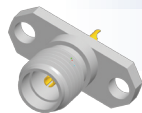

Part Number	Body Material	Plating		Terminal Type
		Body	Contact	
901-9893-RFX	Brass	Nickel	Gold	Solder Cup
901-9892-RFX	Brass	Nickel	Gold	Solder Cup
901-9891-RFX	Brass	Nickel	Gold	Blunt Post
901-9887-RFX	Brass	Nickel	Gold	Blunt Post

Bulkhead Jacks

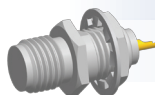

Part Number	Body Material	Plating		Terminal Type	Description
		Body	Contact		
901-9889-RFX	Brass	Nickel	Gold	Solder Cup	Front Mount
901-9890-RFX	Brass	Nickel	Gold	Solder Cup	Rear Mount

Printed Circuit Board Connectors

Straight Plugs

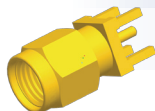

Part Number	Body Material	Plating		Terminal Type	Description
		Body	Contact		
901-9895-RFX	Brass	Gold	Gold	Thru-Hole	Four Legs

Angle Plugs



Part Number	Body Material	Plating		Terminal Type	Description
		Body	Contact		
901-9894-RFX	Brass	Gold	Gold	Thru-Hole	Four Legs

Straight Jacks

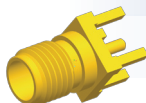

Part Number	Body Material	Plating		Terminal Type	Description
		Body	Contact		
901-144-8RFX	Brass	Gold	Gold	Thru-Hole	Four Legs
901-144	Stainless Steel	Gold	Gold	Thru-Hole	Four Legs
901-144-2	Stainless Steel	Gold	Gold	Thru-Hole	Four Legs
901-144-3	Stainless Steel	Gold	Gold	Thru-Hole	Four Legs
901-144-4	Stainless Steel	Gold	Gold	Thru-Hole	Four Legs

Printed Circuit Board Connectors (continued)

Angle Jacks

Part Number	Body Material	Plating		Terminal Type	Description
		Body	Contact		
901-143-6RFX	Brass	Gold	Gold	Thru-Hole	Four Legs
901-143	Stainless Steel	Gold	Gold	Thru-Hole	Four Legs
901-143-3	Stainless Steel	Gold	Gold	Thru-Hole	Four Legs
901-143-4	Stainless Steel	Gold	Gold	Thru-Hole	Four Legs

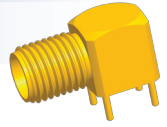

Edge Mount Jacks

Part Number	Body Material	Plating		Terminal Type
		Body	Contact	
901-9850	Brass	Nickel	Gold	Blunt Post
901-10003	Brass	Gold	Gold	Blunt Post
901-10019	Brass	Gold	Gold	Blunt Post
901-10110	Brass	Gold	Gold	Tab
901-10111	Brass	Gold	Gold	Tab
901-10044-4RFX	Brass	Gold	Gold	Tab
901-10044-6RFX	Brass	Gold	Gold	Blunt Post
901-10186	Brass	Gold	Gold	Blunt Post
901-1004-3RFX	Brass	Gold	Gold	Tab
901-1004-2RFX	Brass	Gold	Gold	Blunt Post
901-1004-1RFX	Brass	Gold	Gold	Blunt Post

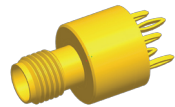
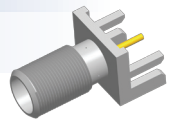

Straight Press Fit Jacks

Part Number	Body Material	Plating		Terminal Type
		Body	Contact	
901-144-PFD	Brass	Nickel	Gold	Compliant Pin
901-144-PF8	Brass	Gold	Gold	Blunt Post

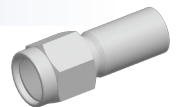

Reverse Polarity Cable Connectors

Straight Plugs

Cable Group	Part Number	Body Material	Plating		Termination	
			Body	Contact	Body	Contact
B	901-9852	Brass	Nickel	Gold	Crimp	Solder
C1	901-9884	Stainless Steel	Passivated	Gold	Crimp	Solder



Angle Plugs

Cable Group	Part Number	Body Material	Plating		Termination	
			Body	Contact	Body	Contact
C1	901-9908	Stainless Steel	Passivated	Gold	Crimp	Solder

Reverse Polarity Cable Connectors (continued)

Straight Bulkhead Jacks

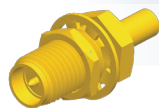

Cable Group	Part Number	Body Material	Plating		Termination	
			Body	Contact	Body	Contact
A	901-9990	Stainless Steel	Passivated	Gold	Crimp	Solder
B	901-9863	Stainless Steel	Passivated	Gold	Crimp	Solder
L	901-9857	Stainless Steel	Passivated	Gold	Crimp	Solder

Reverse Polarity Printed Circuit Board Connectors

Angle Jacks



Part Number	Body Material	Plating		Description
		Body	Contact	
901-9865	Stainless Steel	Gold	Gold	Post Terminal

Edge Mount Jacks

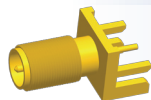

Part Number	Body Material	Plating		Description
		Body	Contact	
901-9864	Brass	Gold	Gold	Post Terminal

Adapters

In-Series Adapters



Part Number	Body Material	Plating		Description
		Body	Contact	
901-9217	Stainless Steel	Gold	Gold	Straight Jack-Jack
901-9217-SF	Stainless Steel	Passivated	Gold	Straight Jack-Jack
901-9216	Stainless Steel	Gold	Gold	Straight Plug-Jack
901-9216-SF	Stainless Steel	Passivated	Gold	Straight Plug-Jack
901-9218	Stainless Steel	Gold	Gold	Straight Plug-Plug
901-9218-SF	Stainless Steel	Passivated	Gold	Straight Plug-Plug
901-125-11	Stainless Steel	Gold	Gold	Angle Plug-Jack
901-125-11SF	Stainless Steel	Passivated	Gold	Angle Plug-Jack

In-Series T-Adapters

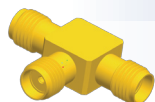

Part Number	Body Material	Plating		Description
		Body	Contact	
901-178	Brass	Gold	Gold	Jack-Jack-Jack
901-382-1	Brass	Gold	Gold	Jack-Jack-Jack

In-Series Bulkhead Adapters

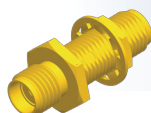

Part Number	Body Material	Plating		Description
		Body	Contact	
901-9209-A	Brass	Gold	Gold	Jack-Jack Front or Rear Mount
901-9209-ASF	Brass	Gold	Gold	Jack-Jack Front or Rear Mount

Notes

Cable Group	Cable Type
A	RG-178, 196
B	RG-174, 188A, 316, Belden 7805
B1	RG-179, 187, Belden 9221
B2	RD-188/U, RD-316/U
B3	RD-179/U, AT&T 19224L2
C	RG-58, 58A, 58C, 141, 303, LMR195, Belden 7806A, 9907
C1	RG-55, 142, 223, 400
C2	LMR200, Belden 7807A
D	RG-58/U Plenum, Thinnet, RG-122/U, Belden 88240, 89907
E	RG-59, 62, 140, 210, Belden 8241, 8263, 8279, 9209
E1	RG-59/U 20 AWG center conductor, Belden 1426A, 1505A, 9100, 9278
E2	RD-59/U, Belden 8281, 9141, 9231
E3	RG-59/U Quad Shield, Belden 1152A
F	RG-59/U Plenum, Belden 1560A, 9259, 82259, 89259, 88241
F1	RG-59/U Plenum 20 AWG center conductor, Belden 82108
G1	RG-6, 143, 212
G2	8X, LMR240, Belden 7808A, 9258
G3	LMR400, Belden 7810A, 8214, 9913
G4	RG-8, 8A, 9, 87A, 213, 214, 225, 393
G5	RD-6/U
H	RG-11
H1	Belden 1694A, 9248
H2	Belden 1859A, 7731, 8213, 9292
H3	RG-54A/U
I	AT&T 734A, Belden 1505A
I2	AT&T 735A, Belden 735A1
J	Quad 59 headend cable
K	LMR600
K2	Belden 1695A
K3	RG-122, 180, 195, Belden 1855, 1865A, 8218
L	.141 semi-rigid, RG-402/U
L2	.085, .086, .087 semi-rigid, RG-405/U
L3	.250 semi-rigid
L4	.047 semi-rigid, Belden 1674
M	1/2 inch annular corrugated
M1	1 1/4 inch annular corrugated
M2	1 5/8 inch annular corrugated
M3	7/8 inch annular corrugated
N	1/4 Helical
N1	3/8 Helical
N2	1/2 Helical
N3	7/8 inch SFC
P1	.81 mm OD micro-cable
P2	1.13 mm OD micro-cable, TCB-068
P3	1.32 mm OD micro-cable
P4	1.37 mm OD micro-cable

Mouser Electronics

Authorized Distributor

Click to View Pricing, Inventory, Delivery & Lifecycle Information:

Amphenol:

[901-116](#) [901-170](#) [901-9511-1SFC](#) [901-9610-12SF](#) [901-9201-2A](#) [901-9511-2](#) [901-9601-1SF](#) [901-101](#) [901-9244-2SF](#) [901-9246-10](#) [901-B2506-493](#) [901-B2509-493](#) [901-B6001-392](#) [901-9CCSF](#) [901-10199](#) [901-155-12](#) [901-178](#)



Компания «ЭлектроПласт» предлагает заключение долгосрочных отношений при поставках импортных электронных компонентов на взаимовыгодных условиях!

Наши преимущества:

- Оперативные поставки широкого спектра электронных компонентов отечественного и импортного производства напрямую от производителей и с крупнейших мировых складов;
- Поставка более 17-ти миллионов наименований электронных компонентов;
- Поставка сложных, дефицитных, либо снятых с производства позиций;
- Оперативные сроки поставки под заказ (от 5 рабочих дней);
- Экспресс доставка в любую точку России;
- Техническая поддержка проекта, помощь в подборе аналогов, поставка прототипов;
- Система менеджмента качества сертифицирована по Международному стандарту ISO 9001;
- Лицензия ФСБ на осуществление работ с использованием сведений, составляющих государственную тайну;
- Поставка специализированных компонентов (Xilinx, Altera, Analog Devices, Intersil, Interpoint, Microsemi, Aeroflex, Peregrine, Syfer, Eurofarad, Texas Instrument, Miteq, Cobham, E2V, MA-COM, Hittite, Mini-Circuits, General Dynamics и др.);

Помимо этого, одним из направлений компании «ЭлектроПласт» является направление «Источники питания». Мы предлагаем Вам помощь Конструкторского отдела:

- Подбор оптимального решения, техническое обоснование при выборе компонента;
- Подбор аналогов;
- Консультации по применению компонента;
- Поставка образцов и прототипов;
- Техническая поддержка проекта;
- Защита от снятия компонента с производства.



Как с нами связаться

Телефон: 8 (812) 309 58 32 (многоканальный)

Факс: 8 (812) 320-02-42

Электронная почта: org@eplast1.ru

Адрес: 198099, г. Санкт-Петербург, ул. Калинина, дом 2, корпус 4, литера А.