

**EProClock<sup>®</sup> PCI Express Gen 2 & Gen 3 Generator**

**Features**

- Optimized 100 MHz Operating Frequencies to Meet the Next Generation PCI-Express Gen 2 & Gen 3
- Low power push-pull type differential output buffers
- Integrated voltage regulator
- Integrated resistors on differential clocks
- Four 100-MHz differential PCI-Express clocks
- Low jitter (<50ps)
- EProClock<sup>®</sup> Programmable Technology
- I<sup>2</sup>C support with readback capabilities
- Triangular Spread Spectrum profile for maximum electromagnetic interference (EMI) reduction
- 25MHz Crystal Input or Clock input
- Industrial Temperature -40°C to 85°C
- 3.3V Power supply
- 32-pin QFN package

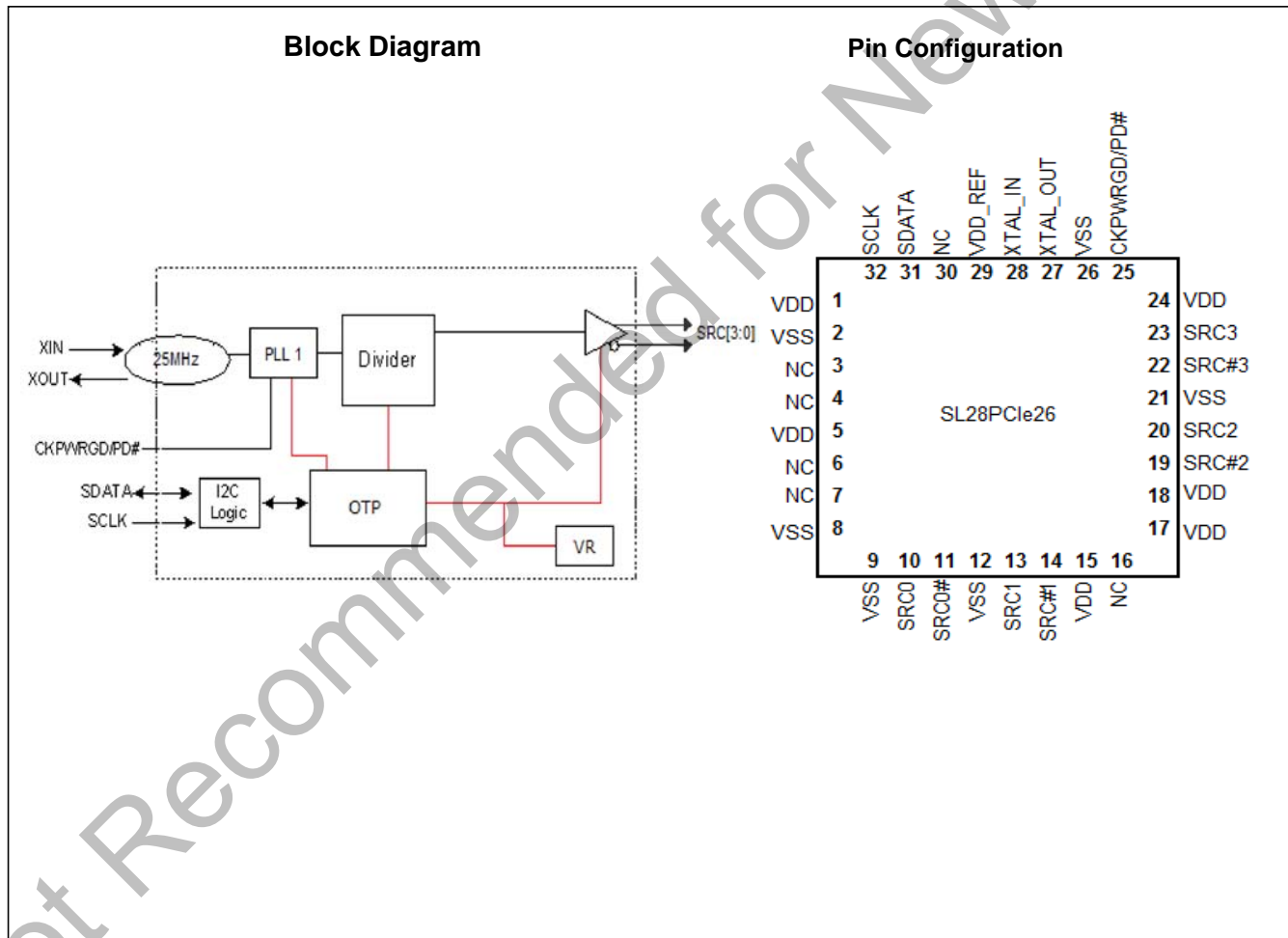

**32-QFN Pin Definitions**

Pin No.	Name	Type	Description
1	VDD	PWR	3.3V Power Supply
2	VSS	GND	Ground
3	NC	NC	No Connect.
4	NC	NC	No Connect.
5	VDD	PWR	3.3V Power Supply
6	NC	NC	No Connect.
7	NC	NC	No Connect.
8	VSS	GND	Ground
9	VSS	GND	Ground
10	SRC0	O, DIF	100MHz True differential serial reference clock
11	SRC0#	O, DIF	100MHz Complement differential serial reference clock
12	VSS	GND	Ground
13	SRC1	O, DIF	100MHz True differential serial reference clock
14	SRC1#	O, DIF	100MHz Complement differential serial reference clock
15	VDD	PWR	3.3V Power Supply
16	NC	NC	No Connect.
17	VDD	PWR	3.3V Power Supply
18	VDD	PWR	3.3V Power Supply
19	SRC2#	O, DIF	100MHz Complement differential serial reference clock
20	SRC2	O, DIF	100MHz True differential serial reference clock
21	VSS	GND	Ground
22	SRC3#	O, DIF	100MHz Complement differential serial reference clock
23	SRC3	O, DIF	100MHz True differential serial reference clock
24	VDD	PWR	3.3V Power Supply
25	CKPWRGD/PD#	I	3.3V LVTTT input pin. When PD# is asserted low, the device will power down.
26	VSS	GND	Ground
27	XOUT	O, SE	25MHz Crystal output, <i>Float XOUT if using CLKIN (Clock Input)</i>
28	XIN/CLKIN	I	25MHz Crystal input or 3.3V, 25MHz Clock Input
29	VDD	PWR	3.3V Power Supply
30	NC	NC	No Connect.
31	SDATA	I/O	SMBus compatible SDATA
32	SCLK	I	SMBus compatible SCLOCK

**EProClock® Programmable Technology**

EProClock® is the world's first non-volatile programmable clock. The EProClock® technology allows board designer to promptly achieve optimum compliance and clock signal integrity; historically, attainable typically through device and/or board redesigns.

EProClock® technology can be configured through SMBus or hard coded.

**Features:**

- > 4000 bits of configurations
- Can be configured through SMBus or hard coded
- Custom frequency sets
- Differential skew control on true or compliment or both

- Differential duty cycle control on true or compliment or both
- Differential amplitude control
- Differential slew rate control
- Program different spread profiles and modulation rates

**Serial Data Interface**

To enhance the flexibility and function of the clock synthesizer, a two-signal serial interface is provided. Through the Serial Data Interface, various device functions, such as individual clock output buffers are individually enabled or disabled. The registers associated with the Serial Data Interface initialize to

their default setting at power-up. The use of this interface is optional. Clock device register changes are normally made at system initialization, if any are required. The interface cannot be used during system operation for power management functions.

**Data Protocol**

The clock driver serial protocol accepts byte write, byte read, block write, and block read operations from the controller. For

block write/read operation, access the bytes in sequential order from lowest to highest (most significant bit first) with the ability to stop after any complete byte is transferred. For byte write and byte read operations, the system controller can access individually indexed bytes. The offset of the indexed byte is encoded in the command code described in *Table 1*.

The block write and block read protocol is outlined in *Table 2* while *Table 3* outlines byte write and byte read protocol. The slave receiver address is 11010010 (D2h).

**Table 1. Command Code Definition**

Bit	Description
7	0 = Block read or block write operation, 1 = Byte read or byte write operation
(6:0)	Byte offset for byte read or byte write operation. For block read or block write operations, these bits should be '0000000'

**Table 2. Block Read and Block Write Protocol**

Block Write Protocol		Block Read Protocol	
Bit	Description	Bit	Description
1	Start	1	Start
8:2	Slave address–7 bits	8:2	Slave address–7 bits
9	Write	9	Write
10	Acknowledge from slave	10	Acknowledge from slave
18:11	Command Code–8 bits	18:11	Command Code–8 bits
19	Acknowledge from slave	19	Acknowledge from slave
27:20	Byte Count–8 bits	20	Repeat start
28	Acknowledge from slave	27:21	Slave address–7 bits
36:29	Data byte 1–8 bits	28	Read = 1
37	Acknowledge from slave	29	Acknowledge from slave
45:38	Data byte 2–8 bits	37:30	Byte Count from slave–8 bits
46	Acknowledge from slave	38	Acknowledge
....	Data Byte /Slave Acknowledges	46:39	Data byte 1 from slave–8 bits
....	Data Byte N–8 bits	47	Acknowledge
....	Acknowledge from slave	55:48	Data byte 2 from slave–8 bits
....	Stop	56	Acknowledge
		....	Data bytes from slave / Acknowledge
		....	Data Byte N from slave–8 bits
		....	NOT Acknowledge
		....	Stop

**Table 3. Byte Read and Byte Write Protocol**

Byte Write Protocol		Byte Read Protocol	
Bit	Description	Bit	Description
1	Start	1	Start
8:2	Slave address–7 bits	8:2	Slave address–7 bits
9	Write	9	Write
10	Acknowledge from slave	10	Acknowledge from slave
18:11	Command Code–8 bits	18:11	Command Code–8 bits
19	Acknowledge from slave	19	Acknowledge from slave
27:20	Data byte–8 bits	20	Repeated start

**Table 3. Byte Read and Byte Write Protocol**

28	Acknowledge from slave	27:21	Slave address–7 bits
29	Stop	28	Read
		29	Acknowledge from slave
		37:30	Data from slave–8 bits
		38	NOT Acknowledge
		39	Stop

**Control Registers**

**Byte 0: Control Register 0**

Bit	@Pup	Name	Description
7	1	RESERVED	RESERVED
6	0	RESERVED	RESERVED
5	1	RESERVED	RESERVED
4	0	RESERVED	RESERVED
3	0	RESERVED	RESERVED
2	0	RESERVED	RESERVED
1	0	RESERVED	RESERVED
0	1	PD_Restore	Save configuration when PD# is asserted 0 = Config. cleared, 1 = Config. saved

**Byte 1: Control Register 1**

Bit	@Pup	Name	Description
7	1	RESERVED	RESERVED
6	0	PLL1_SS_DC	Select for down or center SS 0 = -0.5% Down spread, 1 = +/-0.5% Center spread
5	0	RESERVED	RESERVED
4	0	RESERVED	RESERVED
3	0	RESERVED	RESERVED
2	1	RESERVED	RESERVED
1	0	RESERVED	RESERVED
0	1	RESERVED	RESERVED

**Byte 2: Control Register 2**

Bit	@Pup	Name	Description
7	1	RESERVED	RESERVED
6	1	RESERVED	RESERVED
5	1	RESERVED	RESERVED
4	1	RESERVED	RESERVED
3	1	RESERVED	RESERVED
2	1	RESERVED	RESERVED
1	1	RESERVED	RESERVED
0	1	RESERVED	RESERVED

**Byte 3: Control Register 3**

Bit	@Pup	Name	Description
-----	------	------	-------------

**Byte 3: Control Register 3**

7	1	RESERVED	RESERVED
6	1	RESERVED	RESERVED
5	1	RESERVED	RESERVED
4	1	RESERVED	RESERVED
3	1	RESERVED	RESERVED
2	1	RESERVED	RESERVED
1	1	RESERVED	RESERVED
0	1	RESERVED	RESERVED

**Byte 4: Control Register 4**

Bit	@Pup	Name	Description
7	1	RESERVED	RESERVED
6	1	SRC0_OE	Output enable for SRC0 0 = Output Disabled, 1 = Output Enabled
5	1	SRC1_OE	Output enable for SRC1 0 = Output Disabled, 1 = Output Enabled
4	0	RESERVED	RESERVED
3	1	SRC3_OE	Output enable for SRC3 0 = Output Disabled, 1 = Output Enabled
2	1	SRC2_OE	Output enable for SRC2 0 = Output Disabled, 1 = Output Enabled
1	0	PLL1_SS_EN	Enable PLL1s spread modulation, 0 = Spread Disabled, 1 = Spread Enabled
0	1	RESERVED	RESERVED

**Byte 5: Control Register 5**

Bit	@Pup	Name	Description
7	0	RESERVED	RESERVED
6	0	RESERVED	RESERVED
5	0	RESERVED	RESERVED
4	0	RESERVED	RESERVED
3	0	RESERVED	RESERVED
2	0	RESERVED	RESERVED
1	0	RESERVED	RESERVED
0	0	RESERVED	RESERVED

**Byte 6: Control Register 6**

Bit	@Pup	Name	Description
7	0	RESERVED	RESERVED
6	0	RESERVED	RESERVED
5	0	RESERVED	RESERVED
4	0	RESERVED	RESERVED
3	0	RESERVED	RESERVED
2	0	RESERVED	RESERVED
1	0	RESERVED	RESERVED
0	0	RESERVED	RESERVED

**Byte 7: Vendor ID**

Bit	@Pup	Name	Description
7	0	Rev Code Bit 3	Revision Code Bit 3
6	1	Rev Code Bit 2	Revision Code Bit 2
5	0	Rev Code Bit 1	Revision Code Bit 1
4	0	Rev Code Bit 0	Revision Code Bit 0
3	1	Vendor ID bit 3	Vendor ID Bit 3
2	0	Vendor ID bit 2	Vendor ID Bit 2
1	0	Vendor ID bit 1	Vendor ID Bit 1
0	0	Vendor ID bit 0	Vendor ID Bit 0

**Byte 8: Control Register 8**

Bit	@Pup	Name	Description
7	1	Device_ID3	RESERVED
6	0	Device_ID2	RESERVED
5	0	Device_ID1	RESERVED
4	0	Device_ID0	RESERVED
3	0	RESERVED	RESERVED
2	0	RESERVED	RESERVED
1	0	RESERVED	RESERVED
0	0	RESERVED	RESERVED

**Byte 9: Control Register 9**

Bit	@Pup	Name	Description
7	0	RESERVED	RESERVED
6	0	RESERVED	RESERVED
5	1	RESERVED	RESERVED
4	0	TEST_MODE_SEL	Test mode select either REF/N or tri-state 0 = All outputs tri-state, 1 = All output REF/N
3	0	TEST_MODE_ENTRY	Allows entry into test mode 0 = Normal Operation, 1 = Enter test mode(s)
2	1	I2C_VOUT<2>	Amplitude configurations differential clocks  I2C_VOUT[2:0] 000 = 0.30V 001 = 0.40V 010 = 0.50V 011 = 0.60V 100 = 0.70V 101 = 0.80V (default) 110 = 0.90V 111 = 1.00V
1	0	I2C_VOUT<1>	
0	1	I2C_VOUT<0>	

**Byte 10: Control Register 10**

Bit	@Pup	Name	Description
7	0	RESERVED	RESERVED
6	0	RESERVED	RESERVED
5	0	RESERVED	RESERVED
4	0	RESERVED	RESERVED
3	0	RESERVED	RESERVED

**Byte 10: Control Register 10**

Bit	@Pup	Name	Description
2	0	RESERVED	RESERVED
1	1	RESERVED	RESERVED
0	1	RESERVED	RESERVED

**Byte 11: Control Register 11**

Bit	@Pup	Name	Description
7	0	RESERVED	RESERVED
6	0	RESERVED	RESERVED
5	0	RESERVED	RESERVED
4	0	RESERVED	RESERVED
3	0	RESERVED	RESERVED
2	1	RESERVED	RESERVED
1	1	RESERVED	RESERVED
0	1	RESERVED	RESERVED

**Byte 12: Byte Count**

Bit	@Pup	Name	Description
7	0	BC7	Byte count register for block read operation. The default value for Byte count is 15. In order to read beyond Byte 15, the user should change the byte count limit.to or beyond the byte that is desired to be read.
6	0	BC6	
5	0	BC5	
4	0	BC4	
3	1	BC3	
2	1	BC2	
1	1	BC1	
0	1	BC0	

**Byte 13: Control Register 13**

Bit	@Pup	Name	Description
7	1	RESERVED	RESERVED
6	1	RESERVED	RESERVED
5	1	RESERVED	RESERVED
4	1	RESERVED	RESERVED
3	1	RESERVED	RESERVED
2	1	RESERVED	RESERVED
1	0	RESERVED	RESERVED
0	0	RESERVED	RESERVED

**Byte 14: Control Register 14**

Bit	@Pup	Name	Description
7	1	RESERVED	RESERVED
6	0	RESERVED	RESERVED
5	1	RESERVED	RESERVED

Bit	@Pup	Name	Description
4	0	OTP_4	OTP_ID Identification for programmed device
3	0	OTP_3	
2	1	OTP_2	
1	0	OTP_1	
0	1	OTP_0	

**Table 4. Output Driver Status**

	All Differential Clocks	
	Clock	Clock#
PD# = 0 (Power down)	Low	Low

**PD# (Power down) Assertion**

When PD is sampled HIGH by two consecutive rising edges of SRCC, differential clocks must held LOW. When PD mode is desired as the initial power on state, PD must be asserted HIGH in less than 10  $\mu$ s after asserting CKPWRGD.

**PD# (Power down) Clarification**

The CKPWRGD/PD# pin is a dual-function pin. During initial power up, the pin functions as CKPWRGD. Once CKPWRGD has been sampled HIGH by the clock chip, the pin assumes PD# functionality. The PD# pin is an asynchronous active LOW input used to shut off all clocks cleanly before shutting off power to the device. This signal is synchronized internally to the device before powering down the clock synthesizer. PD# is also an asynchronous input for powering up the system. When PD# is asserted LOW, clocks are driven to a LOW value and held before turning off the VCOs and the crystal oscillator.

**PD# Deassertion**

The power up latency is less than 1.8 ms. This is the time from the deassertion of the PD# pin or the ramping of the power supply until the time that stable clocks are generated from the clock chip. All differential outputs stopped in a three-state condition, resulting from power down are driven high in less than 300  $\mu$ s of PD# deassertion to a voltage greater than 200 mV. After the clock chip's internal PLL is powered up and locked, all outputs are enabled within a few clock cycles of each clock. *Figure 2* is an example showing the relationship of clocks coming up.

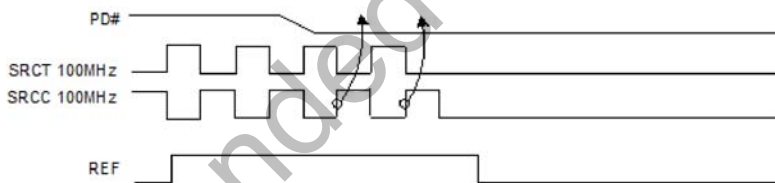

**Figure 1. Power down Assertion Timing Waveform**

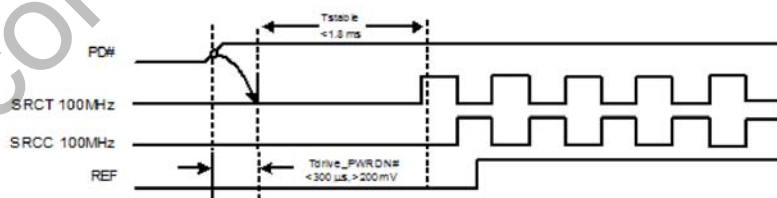

**Figure 2. Power down Deassertion Timing Waveform**



**Absolute Maximum Conditions**

Parameter	Description	Condition	Min.	Max.	Unit
V <sub>DD_3.3V</sub>	Main Supply Voltage	Functional	–	4.6	V
V <sub>IN</sub>	Input Voltage	Relative to V <sub>SS</sub>	–0.5	4.6	V <sub>DC</sub>
T <sub>S</sub>	Temperature, Storage	Non-functional	–65	150	°C
T <sub>A</sub>	Temperature, Operating Ambient, Commercial	Functional	0	85	°C
T <sub>A</sub>	Temperature, Operating Ambient, Industrial	Functional	–40	85	°C
T <sub>J</sub>	Temperature, Junction	Functional	–	150	°C
∅ <sub>JC</sub>	Dissipation, Junction to Case	JEDEC (JESD 51)	–	20	°C/W
∅ <sub>JA</sub>	Dissipation, Junction to Ambient	JEDEC (JESD 51)	–	60	°C/W
ESD <sub>HBM</sub>	ESD Protection (Human Body Model)	JEDEC (JESD 22 - A114)	2000	–	V
UL-94	Flammability Rating	UL (Class)	V-0		

**DC Electrical Specifications**

Parameter	Description	Condition	Min.	Max.	Unit
V <sub>DD core</sub>	3.3V Operating Voltage	3.3 ± 5%	3.135	3.465	V
V <sub>IH</sub>	3.3V Input High Voltage (SE)		2.0	V <sub>DD</sub> + 0.3	V
V <sub>IL</sub>	3.3V Input Low Voltage (SE)		V <sub>SS</sub> – 0.3	0.8	V
V <sub>IH12C</sub>	Input High Voltage	S <sub>DATA</sub> , S <sub>CLK</sub>	2.2	–	V
V <sub>IL12C</sub>	Input Low Voltage	S <sub>DATA</sub> , S <sub>CLK</sub>	–	1.0	V
I <sub>IH</sub>	Input High Leakage Current	Except internal pull-down resistors, 0 < V <sub>IN</sub> < V <sub>DD</sub>	–	5	µA
I <sub>IL</sub>	Input Low Leakage Current	Except internal pull-up resistors, 0 < V <sub>IN</sub> < V <sub>DD</sub>	–5	–	µA
I <sub>OZ</sub>	High-impedance Output Current		–10	10	µA
C <sub>IN</sub>	Input Pin Capacitance		1.5	5	pF
C <sub>OUT</sub>	Output Pin Capacitance		–	6	pF
L <sub>IN</sub>	Pin Inductance		–	7	nH
I <sub>DD_PD</sub>	Power Down Current		–	1	mA
I <sub>DD_3.3V</sub>	Dynamic Supply Current	All outputs enabled. Differential clocks with 7” traces 2pF load.	–	50	mA

**AC Electrical Specifications**

Parameter	Description	Condition	Min.	Max.	Unit
<b>Crystal</b>					
L <sub>ACC</sub>	Long-term Accuracy	Measured at VDD/2 differential	–	250	ppm
<b>Clock Input</b>					
T <sub>DC</sub>	CLKIN Duty Cycle	Measured at VDD/2	47	53	%
T <sub>R</sub> /T <sub>F</sub>	CLKIN Rise and Fall Times	Measured between 0.2V <sub>DD</sub> and 0.8V <sub>DD</sub>	0.5	4.0	V/ns
T <sub>CCJ</sub>	CLKIN Cycle to Cycle Jitter	Measured at VDD/2	–	250	ps
T <sub>LTJ</sub>	CLKIN Long Term Jitter	Measured at VDD/2	–	350	ps
V <sub>IH</sub>	Input High Voltage	XIN / CLKIN pin	2	VDD+0.3	V
V <sub>IL</sub>	Input Low Voltage	XIN / CLKIN pin	–	0.8	V
I <sub>IH</sub>	Input High Current	XIN / CLKIN pin, VIN = VDD	–	35	uA
I <sub>IL</sub>	Input Low Current	XIN / CLKIN pin, 0 < VIN < 0.8	-35	–	uA
<b>SRC at 0.7V</b>					
T <sub>DC</sub>	Duty Cycle	Measured at 0V differential	45	55	%
T <sub>PERIOD</sub>	Period	Measured at 0V differential at 0.1s	9.99900	10.0010	ns
T <sub>PERIODSS</sub>	Period, SSC	Measured at 0V differential at 0.1s	10.02406	10.02607	ns
T <sub>PERIODAbs</sub>	Absolute Period	Measured at 0V differential at 1 clock	9.87400	10.1260	ns
T <sub>PERIODSSAbs</sub>	Absolute Period, SSC	Measured at 0V differential at 1 clock	9.87406	10.1762	ns
T <sub>CCJ</sub>	Cycle to Cycle Jitter	Measured at 0V differential	–	125	ps
RMS <sub>GEN1</sub>	Output PCIe* Gen1 REFCLK phase jitter	BER = 1E-12 (including PLL BW 8 - 16 MHz, ζ = 0.54, Td=10 ns, Ftrk=1.5 MHz)	0	108	ps
RMS <sub>GEN2</sub>	Output PCIe* Gen2 REFCLK phase jitter	Includes PLL BW 8 - 16 MHz, Jitter Peaking = 3dB, ζ = 0.54, Td=10 ns), Low Band, F < 1.5MHz	0	3.0	ps
RMS <sub>GEN2</sub>	Output PCIe* Gen2 REFCLK phase jitter	Includes PLL BW 8 - 16 MHz, Jitter Peaking = 3dB, ζ = 0.54, Td=10 ns), Low Band, F < 1.5MHz	0	3.1	ps
RMS <sub>GEN3</sub>	Output phase jitter impact – PCIe* Gen3	Includes PLL BW 2 - 4 MHz, CDR = 10MHz)	0	1.0	ps
L <sub>ACC</sub>	Long Term Accuracy	Measured at 0V differential	–	100	ppm
T <sub>R</sub> / T <sub>F</sub>	Rising/Falling Slew Rate	Measured differentially from ±150 mV	2.5	8	V/ns
V <sub>HIGH</sub>	Voltage High			1.15	V
V <sub>LOW</sub>	Voltage Low		-0.3	–	V
V <sub>OX</sub>	Crossing Point Voltage at 0.7V Swing		300	550	mV
<b>ENABLE/DISABLE and SET-UP</b>					
T <sub>STABLE</sub>	Clock Stabilization from Power-up		–	1.8	ms
T <sub>SS</sub>	Stopclock Set-up Time		10.0	–	ns

**Test and Measurement Set-up**

**For Differential Clock Signals**

This diagram shows the test load configuration for the differential clock signals

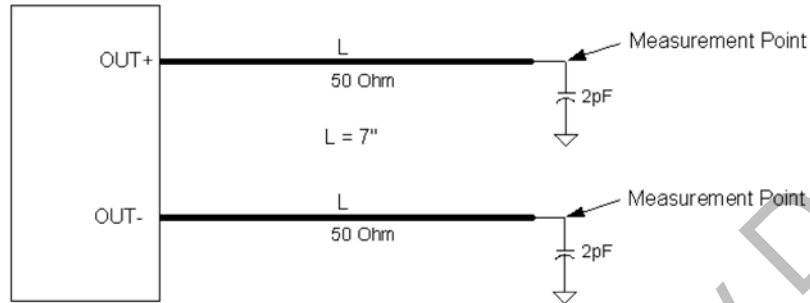

**Figure 3. 0.7V Differential Load Configuration**

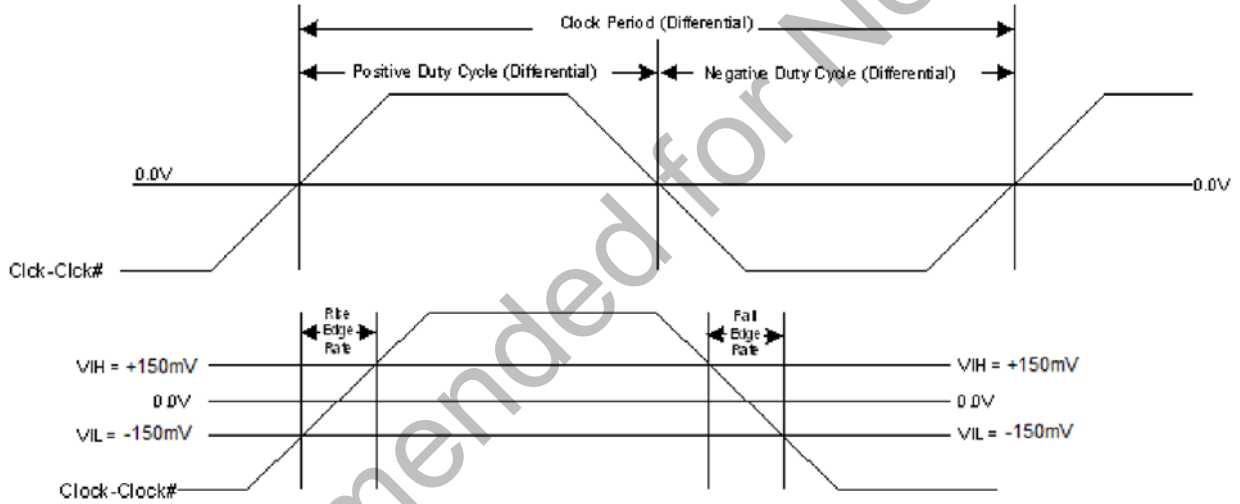

**Figure 4. Differential Measurement for Differential Output Signals (for AC Parameters Measurement)**

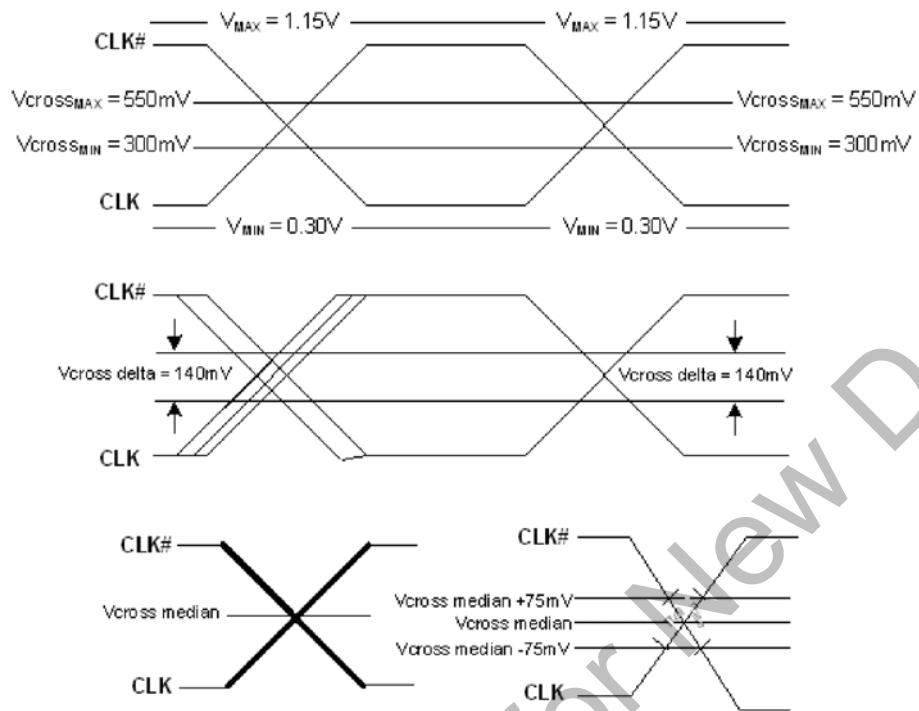

**Figure 5. Single-ended Measurement for Differential Output Signals (for AC Parameters Measurement)**

**Ordering Information**

Part Number	Package Type	Product Flow
<b>Lead-free</b>		
SL28PCle26ALC	32-pin QFN	Industrial, 0° to 85°C
SL28PCle26ALCT	32-pin QFN–Tape and Reel	Industrial, 0° to 85°C
SL28PCle26ALI	32-pin QFN	Industrial, -40° to 85°C
SL28PCle26ALIT	32-pin QFN–Tape and Reel	Industrial, -40° to 85°C

**Package Diagrams**

**32-Lead QFN 5x 5mm**

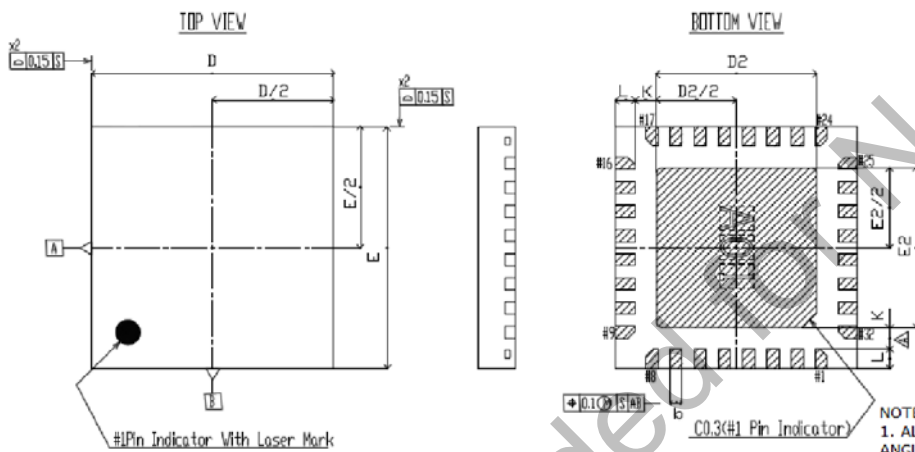

- NOTE:**
1. ALL DIMENSIONS ARE IN MILLIMETERS, ANGLES ARE IN DEGREES.
  2. DIMENSIONAL TOLERANCE UNLESS OTHERWISE SPECIFIED +/- 0.10.
  3. THE SURFACE OF THE PACKAGE SHALL BE RZ 4-8µM
  4. PROTRUSIONS AT THE PKG. OUTLINE SHALL NOT EXCEED 0.10.

≠TRACE CODE: BOTTOM SIDE HALF ETCHING (DEPTH=0.REF)  
 ① A,B,-JK (FRAME ROW)  
 ② ③ ④  
 ⑤ ⑥ ⑦ ⑧ ⑨ ⑩ ⑪ ⑫ ⑬ ⑭ ⑮ ⑯ ⑰ ⑱ ⑲ ⑳ ㉑ ㉒ ㉓ ㉔ ㉕ ㉖ ㉗ ㉘ ㉙ ㉚ ㉛ ㉜ ㉝ ㉞ ㉟ ㊱ ㊲ ㊳ ㊴ ㊵ ㊶ ㊷ ㊸ ㊹ ㊺

SYMBOL	COMMON DIMENSIONS		
	MIN	NOM	MAX
A	0.70	0.75	0.80
A2	0.20 REF.		
b	0.20	0.25	0.30
D	4.90	5.00	5.10
D2	3.15	3.30	3.45
E	4.90	5.00	5.10
E2	3.15	3.30	3.45
e	0.50 BSC.		
k	0.41	—	—
L	0.30	0.40	0.50

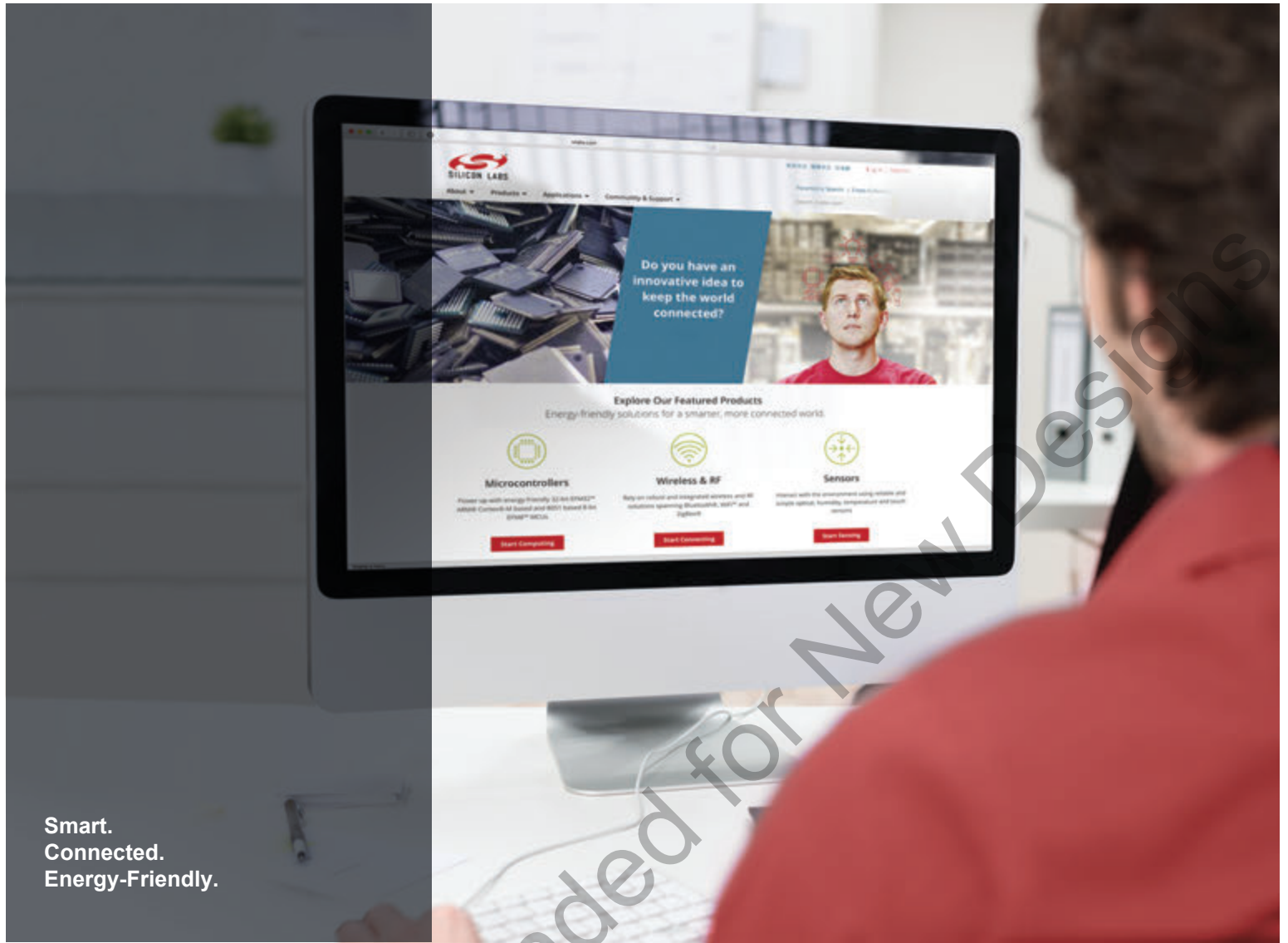

Smart.  
Connected.  
Energy-Friendly.



**Products**  
[www.silabs.com/products](http://www.silabs.com/products)

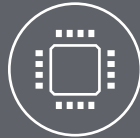

**Quality**  
[www.silabs.com/quality](http://www.silabs.com/quality)



**Support and Community**  
[community.silabs.com](http://community.silabs.com)

**Disclaimer**  
Silicon Labs intends to provide customers with the latest, accurate, and in-depth documentation of all peripherals and modules available for system and software implementers using or intending to use the Silicon Labs products. Characterization data, available modules and peripherals, memory sizes and memory addresses refer to each specific device, and "Typical" parameters provided can and do vary in different applications. Application examples described herein are for illustrative purposes only. Silicon Labs reserves the right to make changes without further notice and limitation to product information, specifications, and descriptions herein, and does not give warranties as to the accuracy or completeness of the included information. Silicon Labs shall have no liability for the consequences of use of the information supplied herein. This document does not imply or express copyright licenses granted hereunder to design or fabricate any integrated circuits. The products are not designed or authorized to be used within any Life Support System without the specific written consent of Silicon Labs. A "Life Support System" is any product or system intended to support or sustain life and/or health, which, if it fails, can be reasonably expected to result in significant personal injury or death. Silicon Labs products are not designed or authorized for military applications. Silicon Labs products shall under no circumstances be used in weapons of mass destruction including (but not limited to) nuclear, biological or chemical weapons, or missiles capable of delivering such weapons.

**Trademark Information**  
Silicon Laboratories Inc.®, Silicon Laboratories®, Silicon Labs®, SiLabs® and the Silicon Labs logo®, Bluegiga®, Bluegiga Logo®, Clockbuilder®, CMEMS®, DSPLL®, EFM®, EFM32®, EFR®, Ember®, Energy Micro, Energy Micro logo and combinations thereof, "the world's most energy friendly microcontrollers", Ember®, EZLink®, EZRadio®, EZRadioPRO®, Gecko®, ISOModem®, Micrium, Precision32®, ProSLIC®, Simplicity Studio®, SiPHY®, Telegesis, the Telegesis Logo®, USBXpress®, Zentri and others are trademarks or registered trademarks of Silicon Labs. ARM, CORTEX, Cortex-M3 and THUMB are trademarks or registered trademarks of ARM Holdings. Keil is a registered trademark of ARM Limited. All other products or brand names mentioned herein are trademarks of their respective holders.



Silicon Laboratories Inc.  
400 West Cesar Chavez  
Austin, TX 78701  
USA

<http://www.silabs.com>



Компания «ЭлектроПласт» предлагает заключение долгосрочных отношений при поставках импортных электронных компонентов на взаимовыгодных условиях!

Наши преимущества:

- Оперативные поставки широкого спектра электронных компонентов отечественного и импортного производства напрямую от производителей и с крупнейших мировых складов;
- Поставка более 17-ти миллионов наименований электронных компонентов;
- Поставка сложных, дефицитных, либо снятых с производства позиций;
- Оперативные сроки поставки под заказ (от 5 рабочих дней);
- Экспресс доставка в любую точку России;
- Техническая поддержка проекта, помощь в подборе аналогов, поставка прототипов;
- Система менеджмента качества сертифицирована по Международному стандарту ISO 9001;
- Лицензия ФСБ на осуществление работ с использованием сведений, составляющих государственную тайну;
- Поставка специализированных компонентов (Xilinx, Altera, Analog Devices, Intersil, Interpoint, Microsemi, Aeroflex, Peregrine, Syfer, Eurofarad, Texas Instrument, Miteq, Cobham, E2V, MA-COM, Hittite, Mini-Circuits, General Dynamics и др.);

Помимо этого, одним из направлений компании «ЭлектроПласт» является направление «Источники питания». Мы предлагаем Вам помощь Конструкторского отдела:

- Подбор оптимального решения, техническое обоснование при выборе компонента;
- Подбор аналогов;
- Консультации по применению компонента;
- Поставка образцов и прототипов;
- Техническая поддержка проекта;
- Защита от снятия компонента с производства.



#### Как с нами связаться

**Телефон:** 8 (812) 309 58 32 (многоканальный)

**Факс:** 8 (812) 320-02-42

**Электронная почта:** [org@eplast1.ru](mailto:org@eplast1.ru)

**Адрес:** 198099, г. Санкт-Петербург, ул. Калинина, дом 2, корпус 4, литера А.