

# Analog Devices Welcomes Hittite Microwave Corporation

NO CONTENT ON THE ATTACHED DOCUMENT HAS CHANGED



**THIS PAGE INTENTIONALLY LEFT BLANK**

### Typical Applications

The HMC907LP5E is ideal for:

- Test Instrumentation
- Microwave Radio & VSAT
- Military & Space
- Telecom Infrastructure
- Fiber Optics

### Features

- High P1dB Output Power: +26 dBm
- High Gain: 12 dB
- High Output IP3: +36 dBm
- Single Supply: +10 V @ 350 mA
- 50 Ohm Matched Input/Output
- 32 Lead 5x5 mm SMT Package: 25 mm<sup>2</sup>

### Functional Diagram

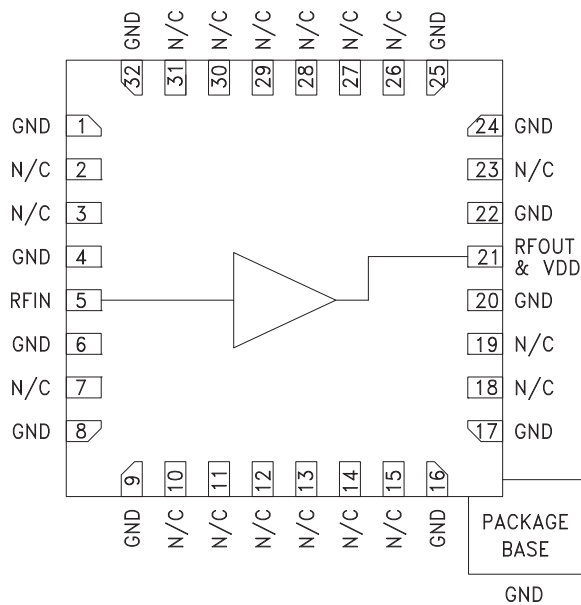

### General Description

The HMC907LP5E is a GaAs MMIC pHEMT Distributed Power Amplifier which operates between 0.2 and 22 GHz. This self-biased power amplifier provides 12 dB of gain, +36 dBm output IP3 and +26 dBm of output power at 1 dB gain compression while requiring only 350 mA from a +10 V supply. Gain flatness is excellent at  $\pm 0.7$  dB from 0.2 to 22 GHz making the HMC907LP5E ideal for EW, ECM, Radar and test equipment applications. The HMC907LP5E amplifier I/Os are internally matched to 50 Ohms facilitating integration into Multi-Chip-Modules (MCMs) and is packaged in a leadless QFN 5x5 mm surface mount package, and requires no external matching components.

### Electrical Specifications, $T_A = +25^\circ\text{C}$ , $V_{dd} = +10\text{ V}$ , $I_{dd} = 350\text{ mA}$

Parameter	Min.	Typ.	Max.	Min.	Typ.	Max.	Min.	Typ.	Max.	Units
Frequency Range	0.2 - 10			10 - 18			18 - 22			GHz
Gain	10	12		10	11.5		10	11.5		dB
Gain Flatness		$\pm 0.7$			$\pm 0.6$			$\pm 0.7$		dB
Gain Variation Over Temperature		0.01			0.013			0.014		dB/°C
Input Return Loss		15			9			8		dB
Output Return Loss		13			12			8		dB
Output Power for 1 dB Compression (P1dB)	23	26		21	25		19.5	21.5		dBm
Saturated Output Power (P <sub>sat</sub> )		28.5			27			24.5		dBm
Output Third Order Intercept (IP3)		36			34			31		dBm
Noise Figure		3.5			3.5			4		dB
Supply Current (I <sub>dd</sub> ) (V <sub>dd</sub> = 10V)		350	400		350	400		350	400	mA

**Gain & Return Loss**

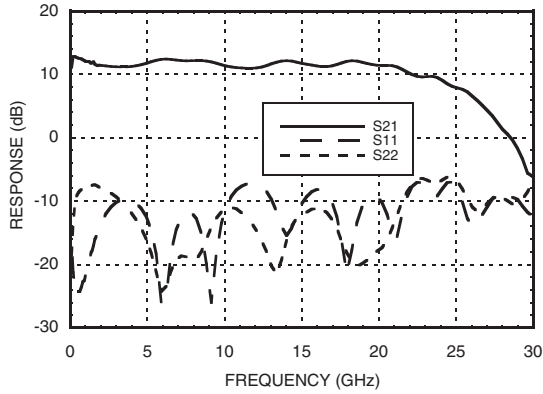

**Gain vs. Temperature**

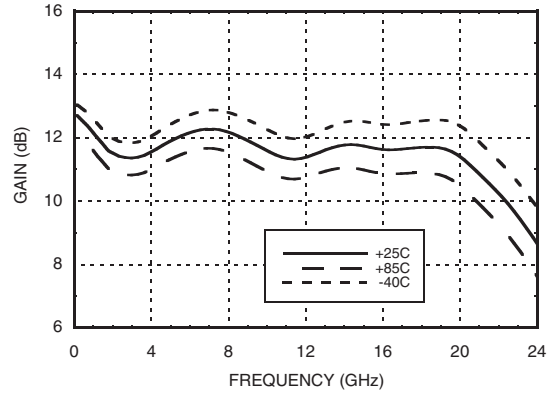

**Input Return Loss vs. Temperature**

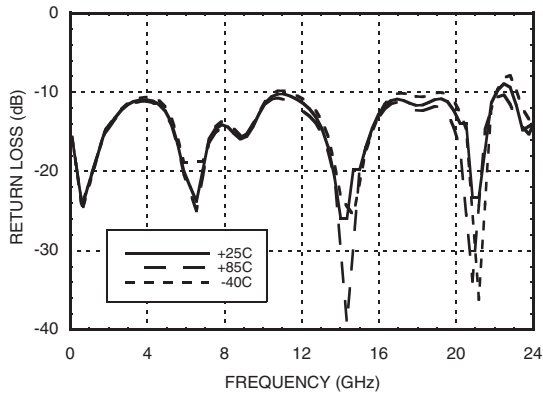

**Output Return Loss vs. Temperature**

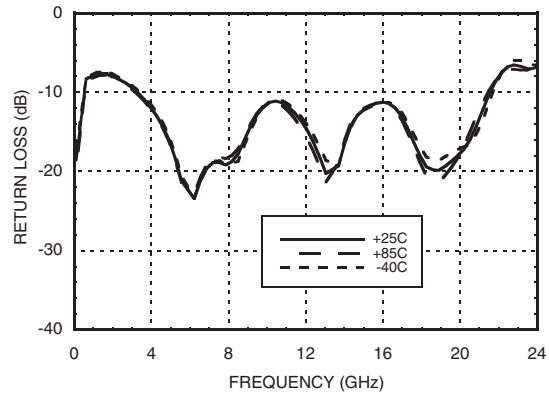

**Reverse Isolation vs. Temperature**

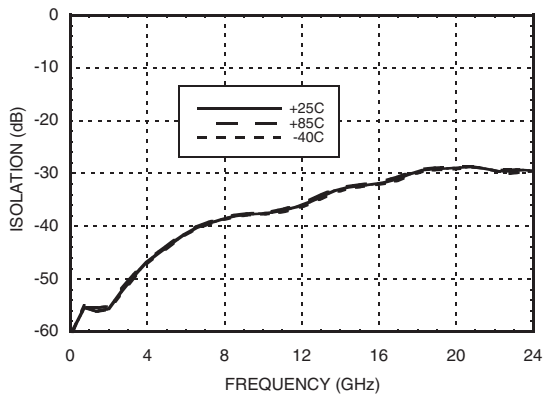

**Gain vs. Vdd**

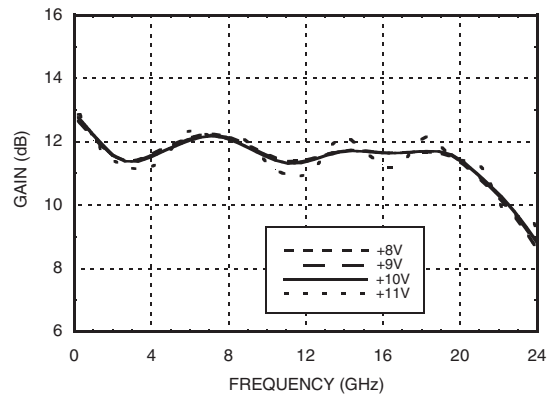



MICROWAVE CORPORATION v00.0510



# HMC907LP5E

## GaAs pHEMT MMIC POWER AMPLIFIER, 0.2 - 22 GHz

### Low Frequency Gain & Return Loss

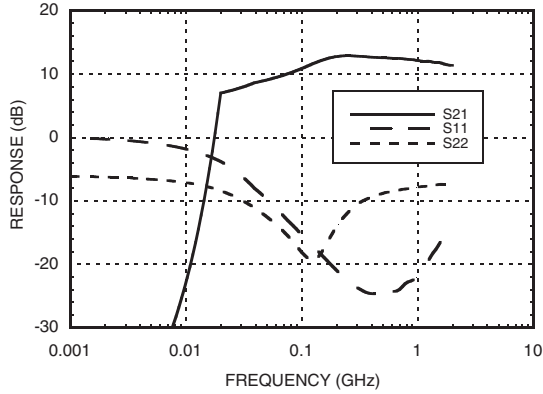

### Noise Figure

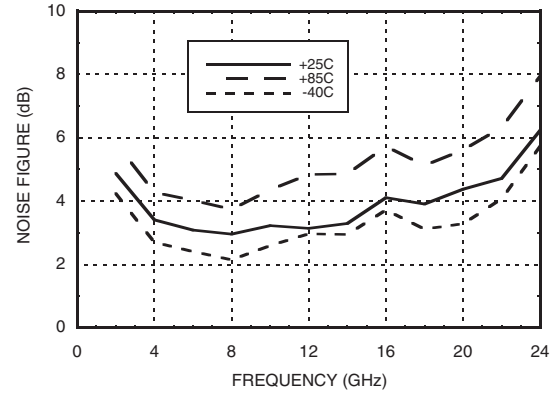

### P1dB vs. Temperature

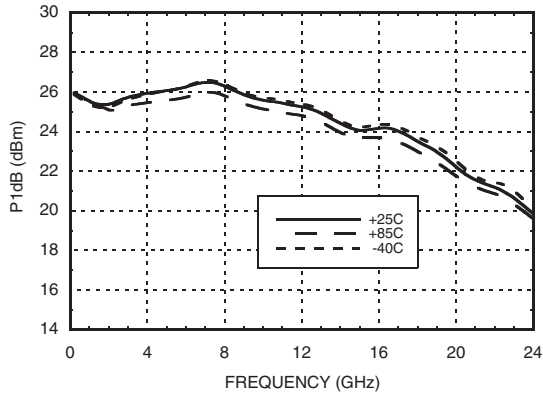

### P1dB vs. Vdd

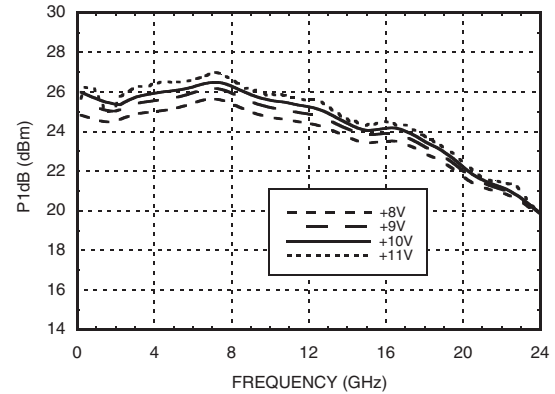

### Psat vs. Temperature

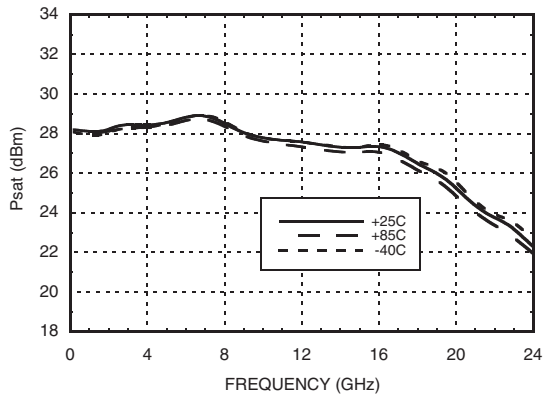

### Psat vs. Vdd

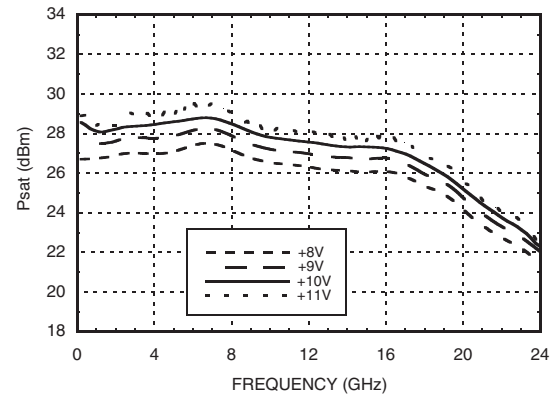

**Output IP3 vs.  
Temperature @ Pout = 16 dBm / Tone**

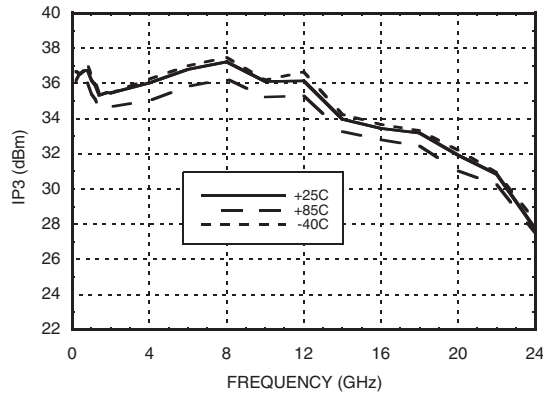

**Output IP3 vs. Vdd @ Pout = 16 dBm / Tone**

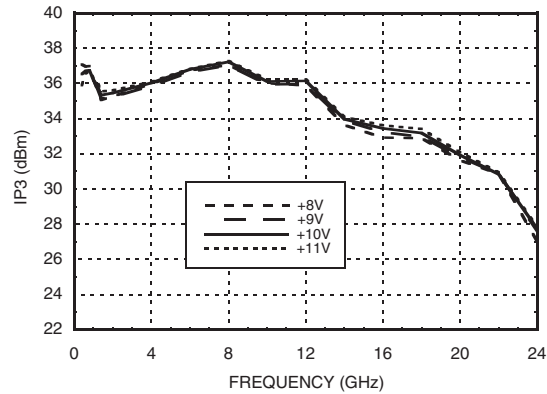

**Output IM3 @ Vdd = 8V**

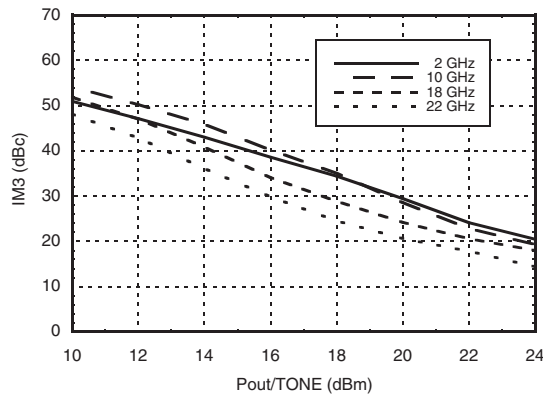

**Output IM3 @ Vdd = 9V**

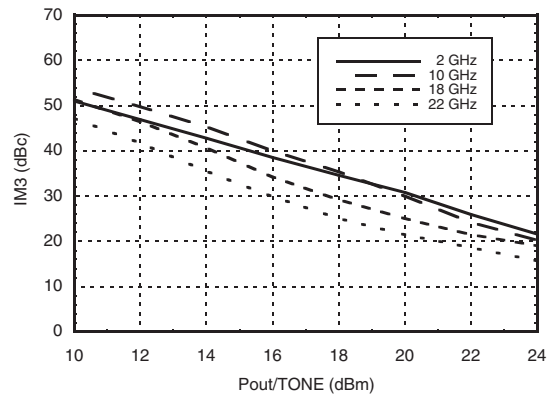

**Output IM3 @ Vdd = 10V**

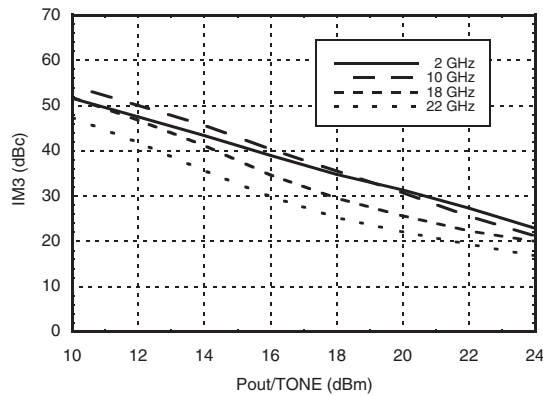

**Output IM3 @ Vdd = 11V**

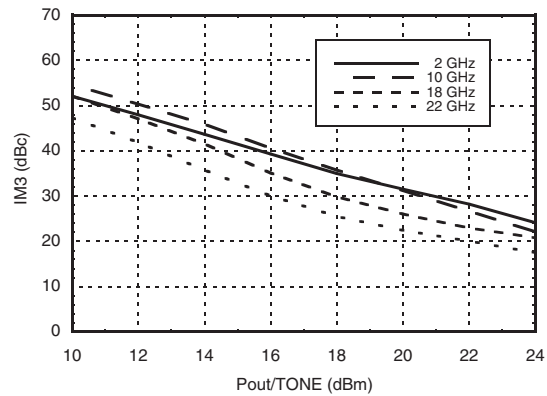



**GaAs pHEMT MMIC  
POWER AMPLIFIER, 0.2 - 22 GHz**

**Power Compression @ 10 GHz**

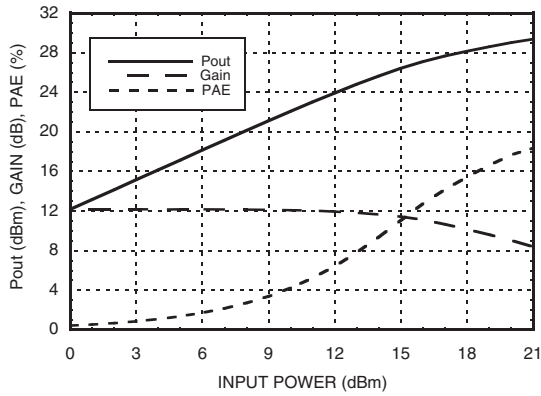

**Gain & Power Supply vs. Supply Current @ 10 GHz**

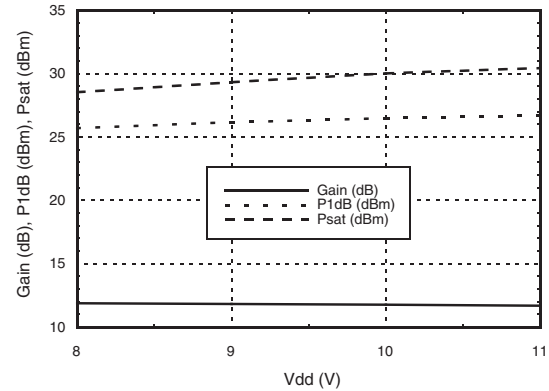

**Power Dissipation**

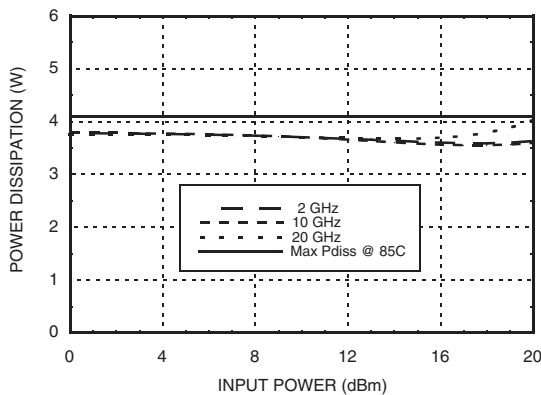

**Second Harmonics vs. Temperature @ Pout = 16 dBm, Vdd = 10V**

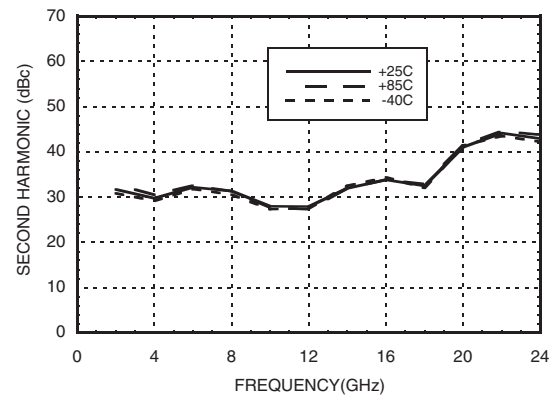

**Second Harmonics vs. Vdd @ Pout = 16 dBm**

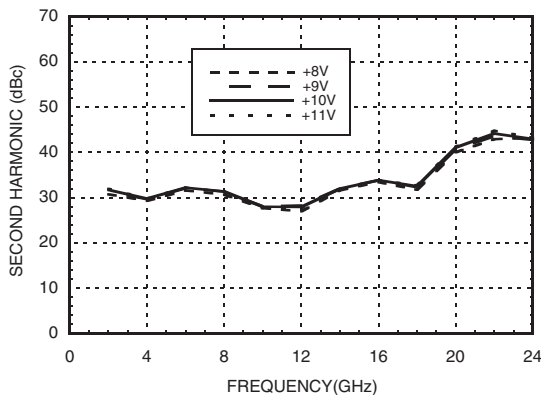

**Second Harmonics vs. Pout @ Vdd = 10V**

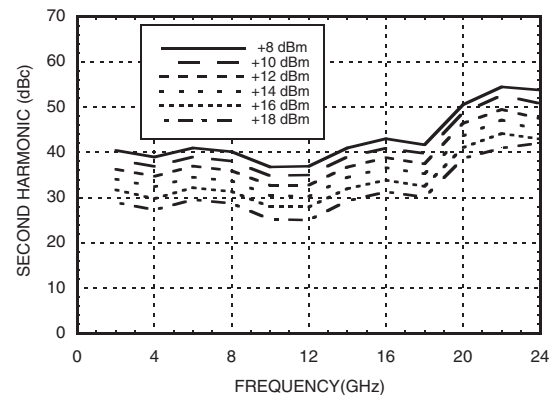

### Absolute Maximum Ratings

Drain Bias Voltage (Vdd)	+11 Vdc
RF Input Power (RFIN)(Vdd = +11V)	+20 dBm
Channel Temperature	150 °C
Continuous Pdiss (T= 85 °C) (derate 63 mW/°C above 85 °C)	4.1 W
Thermal Resistance (channel to ground paddle)	15.9 °C/W
Storage Temperature	-65 to 150°C
Operating Temperature	-55 to 85 °C
ESD Sensitivity (HBM)	Class 1A

### Typical Supply Current vs. Vdd

Vdd (V)	Idd (mA)
+8	335
+9	343
+10	350
+11	357



ELECTROSTATIC SENSITIVE DEVICE  
OBSERVE HANDLING PRECAUTIONS

9

### Outline Drawing

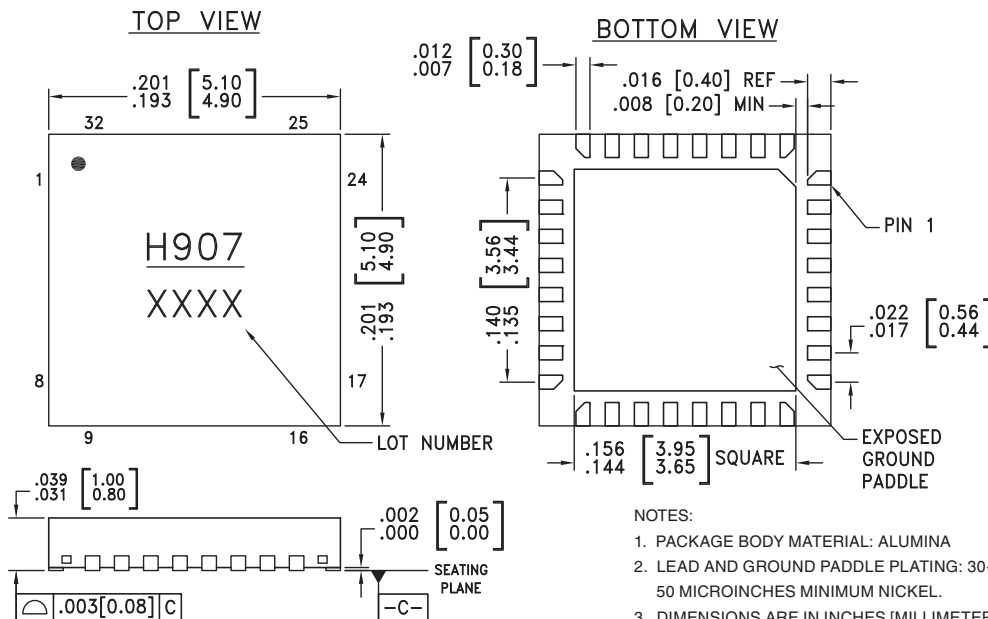

### Package Information

Part Number	Package Body Material	Lead Finish	MSL Rating	Package Marking <sup>[1]</sup>
HMC907LP5E	RoHS-compliant Low Stress Injection Molded Plastic	100% matte Sn	MSL1 <sup>[2]</sup>	H907 XXXX

[1] 4-Digit lot number XXXX

[2] Max peak reflow temperature of 260 °C



### Pin Descriptions

Pin Number	Function	Description	Interface Schematic
1, 4, 6, 8, 9, 16, 17, 20, 22, 24, 25, 32	GND	Package bottom has exposed metal paddle that must be connected to RF/DC ground.	
2, 3, 7, 10 - 15, 18, 19, 23, 26 - 31	N/C	The pins are not connected internally; however, all data shown herein was measured with these pins connected to RF/DC ground externally.	
5	RFIN	This pin is DC coupled and matched to 50 Ohms. Blocking capacitor is required.	
21	RFOUT & Vdd	RF output for amplifier. Connect DC bias (Vdd) network to provide drain current (Idd). See application circuit herein.	

### Application Circuit

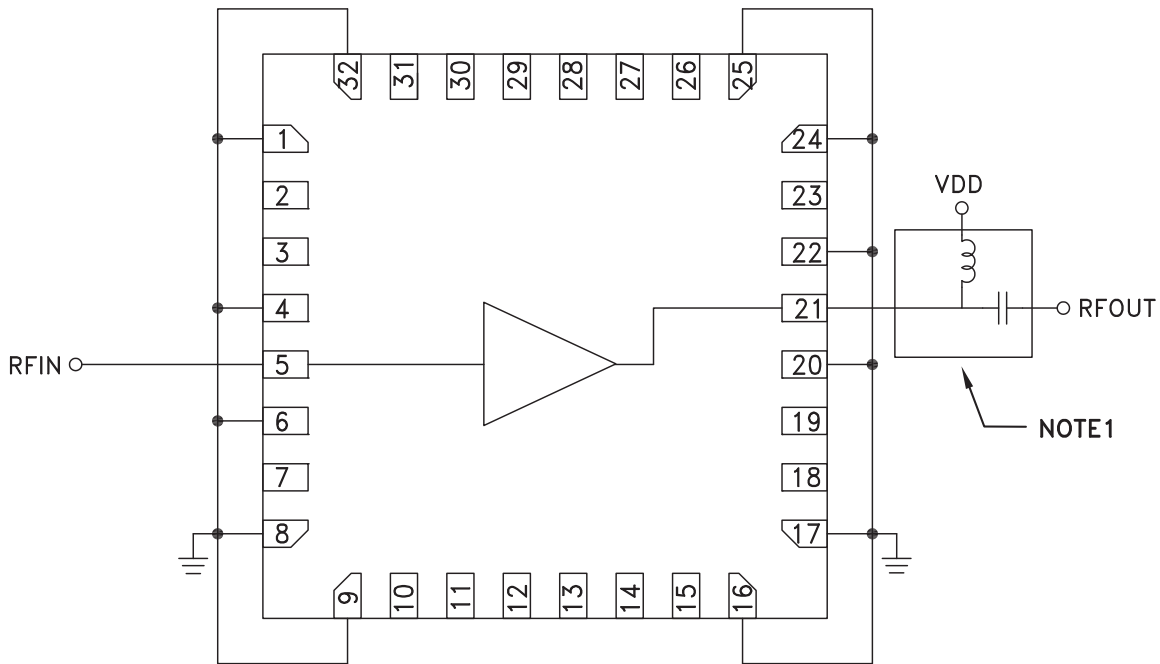

NOTE 1: Drain Bias (Vdd) must be applied through a broadband bias tee or external bias network.

**Evaluation PCB**

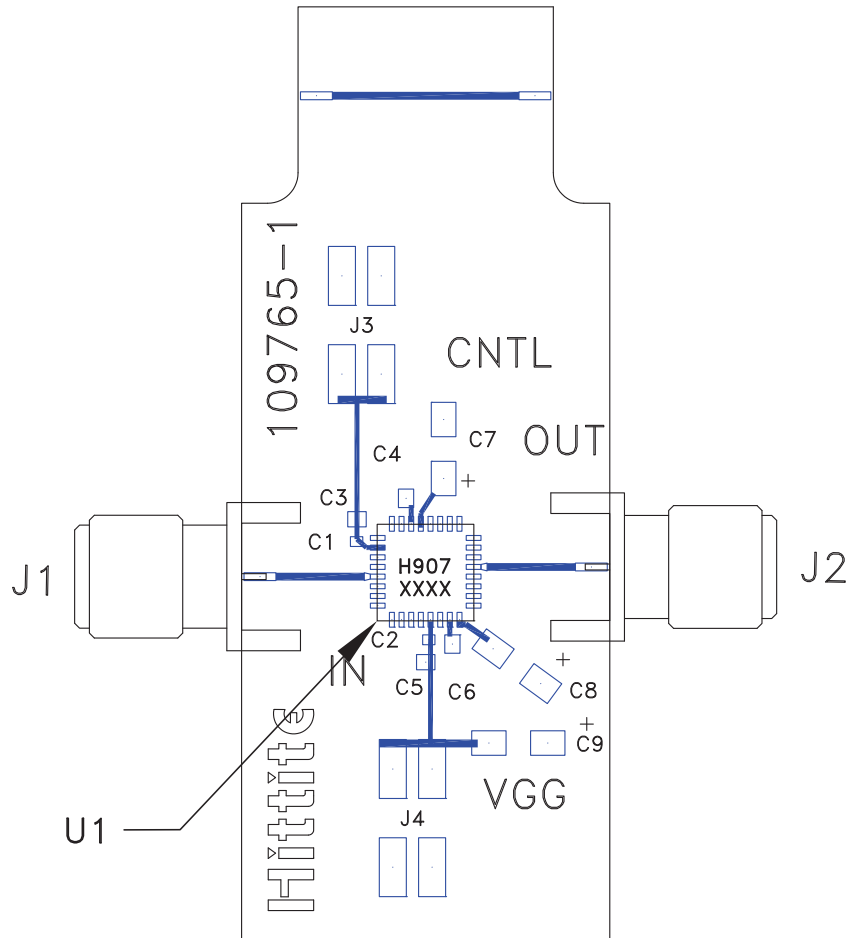

**List of Materials for Evaluation PCB 130812 [1]**

Item	Description
J1, J2	SMA Connector
U1	HMC907LP5E Power Amplifier
PCB [2]	109765 Evaluation PCB

[1] Reference this number when ordering complete evaluation PCB

[2] Circuit Board Material: Rogers 4350 or Arlon FR4

The circuit board used in the application should use RF circuit design techniques. Signal lines should have 50 Ohm impedance while the package ground leads and exposed paddle should be connected directly to the ground plane similar to that shown. A sufficient number of via holes should be used to connect the top and bottom ground planes. The evaluation board should be mounted to an appropriate heat sink. The evaluation circuit board shown is available from Hittite upon request.



Компания «ЭлектроПласт» предлагает заключение долгосрочных отношений при поставках импортных электронных компонентов на взаимовыгодных условиях!

Наши преимущества:

- Оперативные поставки широкого спектра электронных компонентов отечественного и импортного производства напрямую от производителей и с крупнейших мировых складов;
- Поставка более 17-ти миллионов наименований электронных компонентов;
- Поставка сложных, дефицитных, либо снятых с производства позиций;
- Оперативные сроки поставки под заказ (от 5 рабочих дней);
- Экспресс доставка в любую точку России;
- Техническая поддержка проекта, помощь в подборе аналогов, поставка прототипов;
- Система менеджмента качества сертифицирована по Международному стандарту ISO 9001;
- Лицензия ФСБ на осуществление работ с использованием сведений, составляющих государственную тайну;
- Поставка специализированных компонентов (Xilinx, Altera, Analog Devices, Intersil, Interpoint, Microsemi, Aeroflex, Peregrine, Syfer, Eurofarad, Texas Instrument, Miteq, Cobham, E2V, MA-COM, Hittite, Mini-Circuits, General Dynamics и др.);

Помимо этого, одним из направлений компании «ЭлектроПласт» является направление «Источники питания». Мы предлагаем Вам помощь Конструкторского отдела:

- Подбор оптимального решения, техническое обоснование при выборе компонента;
- Подбор аналогов;
- Консультации по применению компонента;
- Поставка образцов и прототипов;
- Техническая поддержка проекта;
- Защита от снятия компонента с производства.



#### Как с нами связаться

**Телефон:** 8 (812) 309 58 32 (многоканальный)

**Факс:** 8 (812) 320-02-42

**Электронная почта:** [org@eplast1.ru](mailto:org@eplast1.ru)

**Адрес:** 198099, г. Санкт-Петербург, ул. Калинина, дом 2, корпус 4, литера А.