

Advantech

AQD-SD3L8GN16-SG1

Datasheet

Rev. 0.0

2017-07-10

Description

AQD-SD3L8GN16-SG1 is a DDR3L 1600Mbps SO-DIMM high-speed, memory module that use 16pcs of 512Mx 64 bits DDR3L SDRAM in FBGA package and a 2K bits serial EEPROM on a 204-pin printed circuit board. AQD-SD3L8GN16-SG1 is a Dual In-Line Memory Module and is intended for mounting into 204-pin edge connector sockets.

Synchronous design allows precise cycle control with the use of system clock. Data I/O transactions are possible on both edges of DQS. Range of operation frequencies, programmable latencies allow the same device to be useful for a variety of high bandwidth, high performance memory system applications.

Features

- Lead-free and Halogen free products are RoHS Compliant
- JEDEC standard 1.35V(1.28V~1.45V) Power supply
- Backward compatible for 1.5V(1.425V~1.575V)
- VDDQ=1.35V(1.28V~1.45V) & 1.5V(1.425V~1.575V)
- MRS Cycle with address key programs
 - CAS Latency(5,6,7,8,9,10,11)
 - Burst Length (BL):8 and 4 with Burst Chop(BC)
- Bi-directional, differential data strobe (DQS and /DQS)
- Differential clock input (CK, /CK) operation
- 8 bit pre-fetch
- Double-data-rate architecture; two data transfers per clock cycle
- Internal calibration through ZQ pin
- On Die Termination with ODT pin
- Auto refresh and self refresh
 - Average Refresh Period 7.8us at lower than TCASE
 - 85°C, 3.9us at 85°C < TCASE ≤ 95°C
- PCB Gold Plating: 30u" min

Pin Identification

Symbol	Function
A0~A14, BA0~BA2	Address/Bank input
DQ0~DQ63	Bi-direction data bus.
DQS0~DQS7	Data strobes
/DQS0~/DQS7	Differential Data strobes
CK0, /CK0,CK1, /CK1	Clock Input. (Differential pair)
CKE0, CKE1	Clock Enable Input.
ODT0, ODT1	On-die termination control line
/S0, /S1	DIMM rank select lines.
/RAS	Row address strobe
/CAS	Column address strobe
/WE	Write Enable
DM0~DM7	Data masks/high data strobes
VDD	Core power supply
VDDQ	I/O driver power supply
V _{REF} DQ	DQ reference supply
V _{REF} CA	Command/address reference supply
V _{DD} SPD	SPD EEPROM power supply
SA0~SA2	I2C serial bus address select for EEPROM
SCL	I2C serial bus clock for EEPROM
SDA	I2C serial bus data for EEPROM
VSS	Ground
/RESET	Set DRAMs Known State
VTT	DRAM I/O termination supply
NC	No Connection

Dimensions (Unit: millimeter)

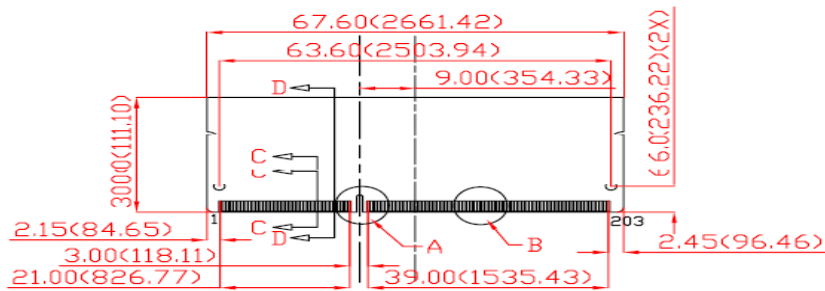
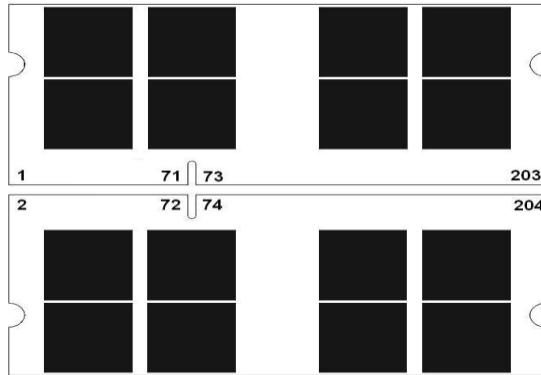

VIEW D-D

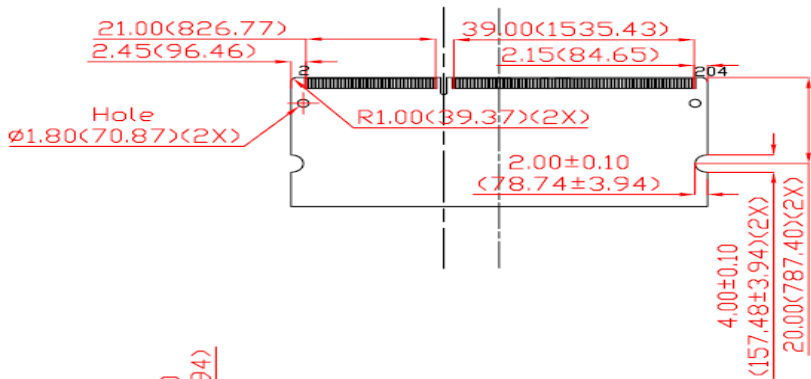
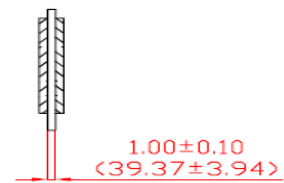

VIEW C-C

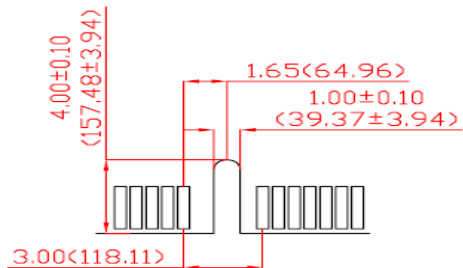
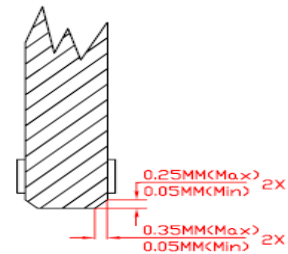

Detail A

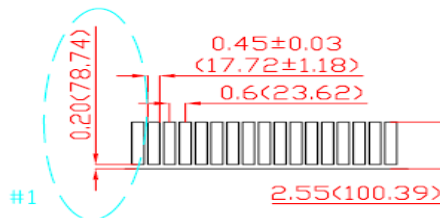

Detail B

Note: 1. Tolerances on all dimensions +/- 0.15mm unless otherwise specified.

Pin Assignments

204-PIN SODIMM Front								204-PIN SODIMM Back							
PIN	Name	PIN	Name	PIN	Name	PIN	Name	PIN	Name	PIN	Name	PIN	Name	PIN	Name
1	VREFDQ	53	DQ19	105	VDD	157	DQ42	2	VSS	54	VSS	106	VDD	158	DQ46
3	VSS	55	VSS	107	A10/AP	159	DQ43	4	DQ4	56	DQ28	108	BA1	160	DQ47
5	DQ0	57	DQ24	109	BA0	161	VSS	6	DQ5	58	DQ29	110	/RAS	162	VSS
7	DQ1	59	DQ25	111	VDD	163	DQ48	8	VSS	60	VSS	112	VDD	164	DQ52
9	VSS	61	VSS	113	/WE	165	DQ49	10	/DQS0	62	/DQ3	114	/S0	166	DQ53
11	DM0	63	DM3	115	/CAS	167	VSS	12	DQS0	64	DQ3	116	ODT0	168	VSS
13	VSS	65	VSS	117	VDD	169	/DQS6	14	VSS	66	VSS	118	VDD	170	DM6
15	DQ2	67	DQ26	119	A13	171	DQS6	16	DQ6	68	DQ30	120	ODT1	172	VSS
17	DQ3	69	DQ27	121	/S1	173	VSS	18	DQ7	70	DQ31	122	NC	174	DQ54
19	VSS	71	VSS	123	VDD	175	DQ50	20	VSS	72	VSS	124	VDD	176	DQ55
21	DQ8	73	CKE0	125	TEST	177	DQ51	22	DQ12	74	CKE1	126	VREFCA	178	VSS
23	DQ9	75	VDD	127	VSS	179	VSS	24	DQ13	76	VDD	128	VSS	180	DQ60
25	VSS	77	NC	129	DQ32	181	DQ56	26	VSS	78	A15	130	DQ36	182	DQ61
27	/DQS1	79	BA2	131	DQ33	183	DQ57	28	DM1	80	A14	132	DQ37	184	VSS
29	DQS1	81	VDD	133	VSS	185	VSS	30	/RESET	82	VDD	134	VSS	186	/DQS7
31	VSS	83	A12//BC	135	/DQS4	187	DM7	32	VSS	84	A11	136	DM4	188	DQS7
33	DQ10	85	A9	137	DQS4	189	VSS	34	DQ14	86	A7	138	VSS	190	VSS
35	DQ11	87	VDD	139	VSS	191	DQ58	36	DQ15	88	VDD	140	DQ38	192	DQ62
37	VSS	89	A8	141	DQ34	193	DQ59	38	VSS	90	A6	142	DQ39	194	DQ63
39	DQ16	91	A5	143	DQ35	195	VSS	40	DQ20	92	A4	144	VSS	196	VSS
41	DQ17	93	VDD	145	VSS	197	SA0	42	DQ21	94	VDD	146	DQ44	198	NC
43	VSS	95	A3	147	DQ40	199	VDDSPD	44	VSS	96	A2	148	DQ45	200	SDA
45	/DQS2	97	A1	149	DQ41	201	SA1	46	DM2	98	A0	150	VSS	202	SCL
47	DQS2	99	VDD	151	VSS	203	VTT	48	VSS	100	VDD	152	/DQS5	204	VTT
49	VSS	101	CK0	153	DM5			50	DQ22	102	CK1	154	DQS5		
51	DQ18	103	/CK0	155	VSS			52	DQ23	104	/CK1	156	VSS		

8GB, 512Mx16 Module (2 Rank x8)

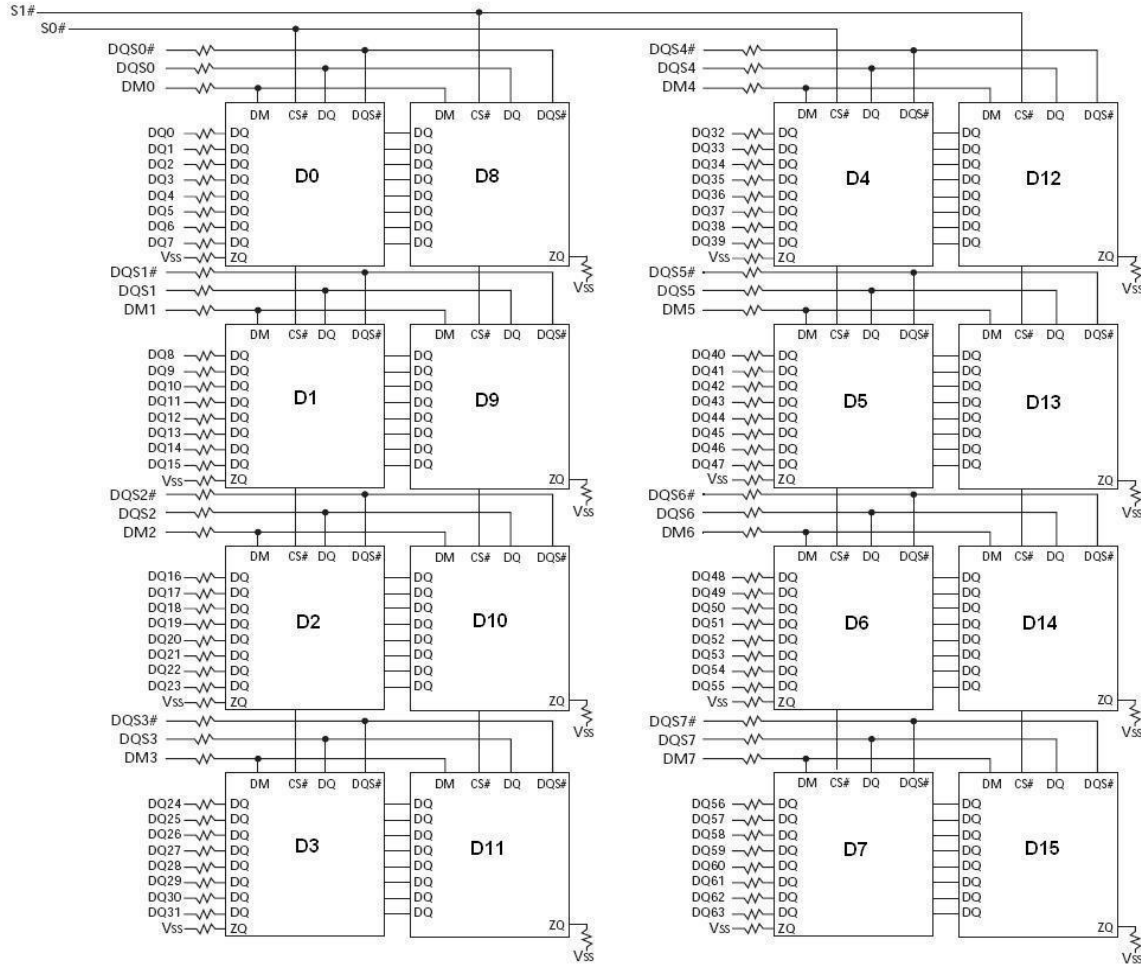

Rank 0 = D0, D1, D2, D3, D4, D5, D6, D7
 Rank 1 = D8, D9, D10, D11, D12, D13, D14, D15

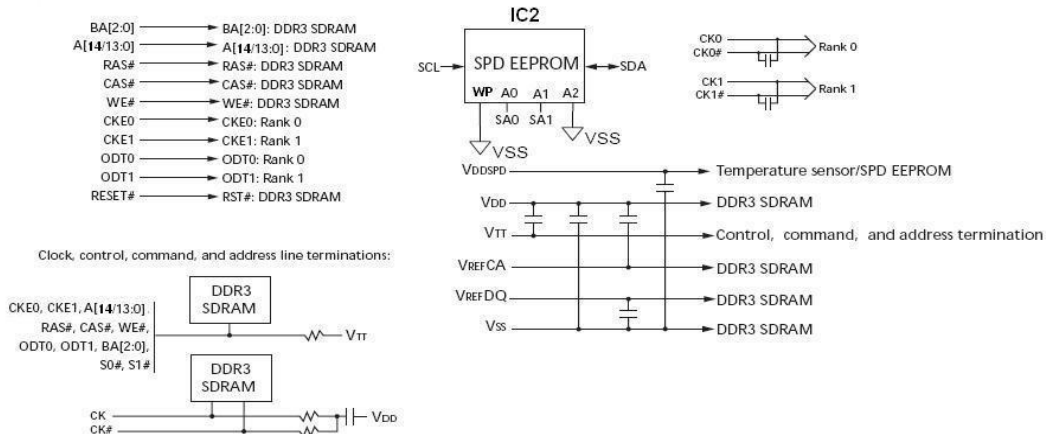

- Notes: 1. The ZQ ball on each DDR3 component is connected to an external $240\Omega \pm 1$ percent resistor that is tied to ground. It is used for the calibration of the component's ODT and output driver.

Operating Temperature Condition

Parameter	Symbol	Rating	Unit	Note
Normal Operating Temperature Range	TOPER	0 to 85	°C	1

Note: Operating Temperature is the case surface temperature on the center/top side of the DRAM. For the measurement conditions, please refer to JESD51-2 standard.

Absolute Maximum DC Ratings

Parameter	Symbol	Value	Unit	Note
Voltage on VDD relative to Vss	VDD	-0.4 ~ 1.975	V	1
Voltage on VDDQ pin relative to Vss	VDDQ	-0.4 ~ 1.975	V	1
Voltage on any pin relative to Vss	VIN, VOUT	-0.4 ~ 1.975	V	1
Storage temperature	TSTG	-55~+100	°C	1,2

Note:

1. Stress greater than those listed under “Absolute Maximum Ratings” may cause permanent damage to the device. This is a stress rating only and functional operation of the device at these or any other conditions above those indicated in the operational sections of this specification is not implied. Exposure to absolute maximum rating conditions for extended periods may affect reliability.
2. Storage Temperature is the case surface temperature on the center/top side of the DRAM. For the measurement conditions, please refer to JESD51-2 standard.

AC & DC Operating Conditions

Recommended DC operating conditions

Parameter	Symbol	Voltage	Rating			Unit	Notes
			Min	Typ.	Max		
Supply voltage	VDD	1.35V	1.283	1.35	1.45	V	1, 2
		1.5V	1.425	1.5	1.575	V	
Supply voltage for Output	VDDQ	1.35V	1.283	1.35	1.45	V	1, 2
		1.5V	1.425	1.5	1.575	V	
I/O Reference Voltage (DQ)	VREF _{DQ} (DC)	1.35V	0.49*VDDQ	0.50*VDDQ	0.51*VDDQ	V	3
I/O Reference Voltage (CMD/ADD)	VREF _{CA} (DC)	1.5V	0.49*VDDQ	0.50*VDDQ	0.51*VDDQ	V	3
AC Input Logic High	VIH(AC)	1.35V	VREF+0.160	-	-	V	
		1.5V	VREF+0.175	-	-	V	
AC Input Logic Low	VIL(AC)	1.35V	-	-	VREF-0.160	V	
		1.5V	-	-	VREF-0.175	V	
DC Input Logic High	VIH(DC)	1.35V	VREF+0.09	-	VDD	V	
		1.5V	VREF+0.1	-	VDD	V	
DC Input Logic Low	VIL(DC)	1.35V	VSS	-	VREF-0.09	V	
		1.5V	VSS	-	VREF-0.1	V	

Note:

1. Under all conditions VDDQ must be less than or equal to VDD.
2. VDDQ tracks with VDD, AC parameters are measured with VDD and VDDQ tied together.
3. Peak to peak AC noise on VREF may not allow deviate from VREF(DC) by more than +/-1% VDD.

IDD Specification parameters Definition - 8GB (2 Rank x8)

Parameter	Symbol	DDR3L 1600 CL11	Unit
Operating One bank Active-Precharge current; tCK = tCK(IDD), tRC = tRC(IDD), tRAS = tRASmin(IDD); CKE is HIGH, /CS is HIGH between valid commands; Address bus inputs are SWITCHING; Data bus inputs are SWITCHING	IDD0	408	mA
Operating One bank Active-read-Precharge current; IOUT = 0mA; BL = 8, CL = CL(IDD), AL = 0; tCK = tCK(IDD), tRC = tRC (IDD), tRAS = tRASmin(IDD), tRCD = tRCD(IDD); CKE is HIGH, /CS is HIGH between valid commands; Address bus inputs are SWITCHING; Data pattern is same as IDD4W	IDD1	512	mA
Precharge power-down current; All banks idle; tCK = tCK(IDD); CKE is LOW; Other control and address bus inputs are STABLE; Data bus inputs are FLOATING	IDD2P	192	mA
Precharge quiet standby current; All banks idle; tCK = tCK(IDD); CKE is HIGH, /CS is HIGH; Other control and address bus inputs are STABLE; Data bus inputs are FLOATING	IDD2Q	320	mA
Precharge standby current; All banks idle; tCK = tCK(IDD); CKE is HIGH, /CS is HIGH; Other control and address bus inputs are SWITCHING; Data bus inputs are SWITCHING	IDD2N	336	mA
Active power - down current; All banks open; tCK = tCK(IDD); CKE is LOW; Other control and address bus inputs are STABLE; Data bus inputs are FLOATING	IDD3P	336	mA
Active standby current; All banks open; tCK = tCK(IDD), tRAS = tRASmax(IDD), tRP = tRP(IDD); CKE is HIGH, /CS is HIGH between valid commands; Other control and address bus inputs are SWITCHING; Data bus inputs are SWITCHING	IDD3N	512	mA
Operating burst read current; All banks open, Continuous burst reads, IOUT = 0mA; BL = 4, CL = CL(IDD), AL = 0; tCK = tCK(IDD), tRAS = tRASmax(IDD), tRP = tRP(IDD); CKE is HIGH, /CS is HIGH between valid commands; Address bus inputs are SWITCHING; Data pattern is same as IDD4W	IDD4R	848	mA
Operating burst write current; All banks open, Continuous burst writes; BL = 8, CL = CL(IDD), AL = 0; tCK = tCK(IDD), tRAS = tRASmax(IDD), tRP = tRP(IDD); CKE is HIGH, /CS is HIGH between valid commands; Address bus inputs are SWITCHING; Data bus inputs are SWITCHING IDD4R	IDD4W	872	mA
Burst refresh current; tCK = tCK(IDD); Refresh command at every tRFC(IDD) interval; CKE is HIGH, /CS is HIGH between valid commands; Other control and address bus inputs are SWITCHING; Data bus inputs are SWITCHING	IDD5	976	mA
Self refresh current; CK and /CK at 0V; CKE = 0.2V; Other control and address bus inputs are FLOATING; Data bus inputs are FLOATING	IDD6	192	mA
Operating bank interleave read current; All bank interleaving reads, IOUT = 0mA; BL = 8, CL = CL(IDD), AL = tRCD(IDD)-1*tCK(IDD); tCK = tCK(IDD), Trc = tRC(IDD), tRRD = tRRD(IDD), tRCD = 1*tCK(IDD); CKE is HIGH, CS is HIGH between valid commands; Address bus inputs are STABLE during DESELECTs; Data pattern is same as IDD4R;	IDD7	1344	mA

Note: 1. Module IDD was calculated on the specific brand DRAM(4xnm) component IDD and can be differently measured according to DQ loading capacitor.

Timing Parameters & Specifications

Speed		DDR3L 1600		Unit
Parameter	Symbol	Min	Max	
Average Clock Period	tCK	8	-	ns
CK high-level width	tCH	0.47	0.53	tCK
CK low-level width	tCL	0.47	0.53	tCK
DQS, /DQS to DQ skew, per group, per access	tDQSQ	-	125	ps
DQ output hold time from DQS, /DQS	tQH	0.38	-	tCK
DQ low-impedance time from CK, /CK	tLZ(DQ)	-450	225	ps
DQ high-impedance time from CK, /CK	tHZ(DQ)	-	225	ps
Data setup time to DQS, /DQS reference to Vih(ac)/Vil(ac) levels	tDS	10	-	ps
Data hold time to DQS, /DQS reference to Vih(ac)/Vil(ac) levels	tDH	45	-	ps
DQ and DM input pulse width for each input	tDIPW	360	-	ps
DQS, /DQS Read preamble	tRPRE	0.9	-	tCK
DQS, /DQS differential Read postamble	tRPST	0.3	-	tCK
DQS, /DQS Write preamble	tWPRE	0.9	-	tCK
DQS, /DQS Write postamble	tWPST	0.3	-	tCK
DQS, /DQS low-impedance time	tLZ(DQS)	-450	225	ps
DQS, /DQS high-impedance time	tHZ(DQS)	-	225	ps
DQS, /DQS differential input low pulse width	tDQSL	0.45	0.55	tCK
DQS, /DQS differential input high pulse width	tDQSH	0.45	0.55	tCK
DQS, /DQS rising edge to CK, /CK rising edge	tDQSS	-0.27	0.27	tCK
DQS, /DQS falling edge setup time to CK, /CK rising edge	tDSS	0.18	-	tCK
DQS, /DQS falling edge hold time to CK, /CK rising edge	tDSH	0.18	-	tCK
Delay from start of Internal write transaction to Internal read command	tWTR	Max (4tck, 7.5ns)	-	
Write recovery time	tWR	15	-	ns
Mode register set command cycle time	tMRD	4	-	tCK
/CAS to /CAS command delay	tCCD	4	-	nCK
Auto precharge write recovery + precharge time	tDAL	tWR+tRP/tck		nCK

Speed		DDR3L 1600		Unit
Parameter	Symbol	Min	Max	
Active to active command period for 1KB page size	tRRD	Max (4tck, 7.5ns)	-	ns
Active to active command period for 2KB page size	tRRD	Max (4tck, 6ns)	-	
Four Activate Window for 1KB page size	tFAW	30	-	ns
Power-up and RESET calibration time	tZQinitl	512	-	tCK
Normal operation Full calibration time	tZQoper	256	-	tCK
Normal operation short calibration time	tZQcs	64	-	tCK
Exit self refresh to commands not requiring a locked DLL	tXS	Max (5tCK, tRFC+10ns)	-	
Exit self refresh to commands requiring a locked DLL	tXSDLL	tDLL(min)	-	tCK
Internal read to precharge command delay	tRTP	Max (4tck, 7.5ns)	-	
Minimum CKE low width for Self refresh entry to exit timing	tCKESR	tCK(min)+1tCK	-	
Exit power down with DLL to any valid command: Exit Precharge Power Down with DLL	tXP	Max (3tCK, 6ns)	-	
CKE minimum pulse width (high and low pulse width)	tCKE	Max (3tCK, 5ns)		
Asynchronous RTT turn-on delay (Power-Down mode)	tAONPD	2	8.5	ns
Asynchronous RTT turn-off delay (Power-Down mode)	tAOFDP	2	8.5	ns
ODT turn-on	tAON	-225	225	ps
ODT turn-off	tAOF	0.3	0.7	tCK

SERIAL PRESENCE DETECT SPECIFICATION (AQD-SD3L8GN16-SG1 Serial Presence Detect)

Byte	Function Described	Function	HEX Value
0	Number of Serial PD Bytes Written / SPD Device Size / CRC Coverage	CRC coverage 0~116Byte,SPD Total :256Byte, SPD Use : 176Byte	92
1	SPD Revision	Version 1.1	11
2	Key Byte / DRAM Device Type	DDR3 SDRAM	0B
3	Key Byte / Module Type	SO-DIMM	03
4	SDRAM Density and Banks	8banks 4Gb	04
5	SDRAM Addressing	Row : 16 Column : 10	21
6	Module Nominal Voltage, VDD	1.35V/1.5V	02
7	Module Organization	2 Rank x8	09
8	Module Memory Bus Width	Non ECC 64bits	03
9	Fine Timebase Dividend and Divisor	2.5 ps	52
10	Medium Timebase Dividend	1/8 (0.125ns)	01
11	Medium Timebase Divisor		08
12	SDRAM Minimum Cycle Time (tCKmin)	1.25 ns	0A
13	Reserved	Reserved	00
14	CAS Latencies Supported, Least Significant Byte	CL5,6,7,8,9,10,11	FE
15	CAS Latencies Supported, Most Significant Byte	CL5,6,7,8,9,10,11	00
16	Minimum CAS Latency Time(tAAmin)	13.125 ns	69
17	Minimum Write Recovery Time (tWRmin)	15 ns	78
18	Minimum RAS# to CAS# Delay Time (tRCDmin)	13.125 ns	69
19	Minimum Row Active to Row Active Delay Time (tRRDmin)	6 ns	30
20	Minimum Row Precharge Time (tRPmin)	13.125 ns	69
21	Upper Nibbles for tRAS and tRC	-	11
22	Minimum Active to Precharge Time (tRASmin), Least Significant Byte	35 ns	18
23	Minimum Active to Active/Refresh Time (tRCmin), Least Significant Byte	48.125 ns	81
24	Minimum Refresh Recovery Time (tRFCmin), Least Significant Byte	280 ns	20
25	Minimum Refresh Recovery Time (tRFCmin), Most Significant Byte	280 ns	08
26	Minimum Internal Write to Read Command Delay Time (tWTRmin)	7.5 ns	3C
27	Minimum Internal Read to Precharge Command Delay Time (tRTPmin)	7.5 ns	3C
28	Upper Nibble for tFAW	30 ns	00
29	Minimum Four Activate Window Delay Time (tFAWmin), Least Significant Byte		F0
30	SDRAM Optional Features	DLL-Off , RZQ/6 , RZQ/7	83
31	SDRAM Thermal and Refresh Options	ASR / 85°C ~95°C 2X refresh rate /95°C	05
32	Module Thermal Sensor	Non Thermal Sensor	00
33	SDRAM Device Type	-	00
34~50	Reserved, General Section	-	00
60	Module Nominal Height	30 mm	0F
61	Module Maximum Thickness	-	11
62	Reference Raw Card Used	Raw Card F Revision 0	05
63	Address Mapping from Edge Connector to DRAM	Standard	00
64-116	Reserved	-	00
117	Module Manufacturer ID Code, Least Significant Byte		04
118	Module Manufacturer ID Code, Most Significant Byte		CB
119	Module ID: Module Manufacturing Location	*Note: 1	-
120	Module ID: Module Manufacturing Date(Year)	*Note: 2	-
121	Module ID: Module Manufacturing Date(Week)	*Note: 3	-
122-125	Module ID : Module Serial Number	*Note: 4	-
126	Cyclical Redundancy Code	CRC-CCITT(LOW)	10
127	Cyclical Redundancy Code	CRC-CCITT(HIGH)	FA
128-145	Module Part Number	*Note: 5	-
146	Module Revision Code	-	00
147	Module Revision Code	-	00
148	SDRAM Manufacturer's JEDEC ID Code	-	00
149	SDRAM Manufacturer's JEDEC ID Code	-	00
150-151	Manufacturer's Specific Data	-	00
152-163	Manufacturer's Specific Data (Working Order Number)	*Note: 6	-
164-175	Manufacturer's Specific Data (SPD Naming Number)	*Note: 7	-
176-255	Open for customer use	*Note: 8	00

Note :

1. Byte 119 -- Manufacturing location by manufacturing location (00:Taiwan /01:China)
2. Byte 120 -- Module manufacturing date by year (YY).
3. Byte 121 -- Module manufacturing date by week (WW).
4. Bytes 122~125 -- Module Serial Number.
5. Bytes 128~145 -- Manufacturer Part Number by module part number , (Unused digits are coded as ASCII blanks (20h)).
6. Bytes 152~163 -- Manufacturer's Specific Data by working order number. (Unused digits are coded as 00h.)
7. Bytes 164~175 -- Manufacturer's Specific Data by SPD naming number. (Unused digits are coded as 00h.)
8. Bytes 176~255 --These bytes are undefined and can be used for ADATA's own purpose. (Unused digits are coded as 00h.)



Компания «ЭлектроПласт» предлагает заключение долгосрочных отношений при поставках импортных электронных компонентов на взаимовыгодных условиях!

Наши преимущества:

- Оперативные поставки широкого спектра электронных компонентов отечественного и импортного производства напрямую от производителей и с крупнейших мировых складов;
- Поставка более 17-ти миллионов наименований электронных компонентов;
- Поставка сложных, дефицитных, либо снятых с производства позиций;
- Оперативные сроки поставки под заказ (от 5 рабочих дней);
- Экспресс доставка в любую точку России;
- Техническая поддержка проекта, помощь в подборе аналогов, поставка прототипов;
- Система менеджмента качества сертифицирована по Международному стандарту ISO 9001;
- Лицензия ФСБ на осуществление работ с использованием сведений, составляющих государственную тайну;
- Поставка специализированных компонентов (Xilinx, Altera, Analog Devices, Intersil, Interpoint, Microsemi, Aeroflex, Peregrine, Syfer, Eurofarad, Texas Instrument, Miteq, Cobham, E2V, MA-COM, Hittite, Mini-Circuits, General Dynamics и др.);

Помимо этого, одним из направлений компании «ЭлектроПласт» является направление «Источники питания». Мы предлагаем Вам помощь Конструкторского отдела:

- Подбор оптимального решения, техническое обоснование при выборе компонента;
- Подбор аналогов;
- Консультации по применению компонента;
- Поставка образцов и прототипов;
- Техническая поддержка проекта;
- Защита от снятия компонента с производства.



Как с нами связаться

Телефон: 8 (812) 309 58 32 (многоканальный)

Факс: 8 (812) 320-02-42

Электронная почта: org@eplast1.ru

Адрес: 198099, г. Санкт-Петербург, ул. Калинина, дом 2, корпус 4, литера А.