

ISL28108, ISL28208, ISL28408

40V Precision Single Supply Rail-to-Rail Output Low Power Operational Amplifiers

FN6935
Rev.5.01
Feb 6, 2020

The [ISL28108](#), [ISL28208](#), and [ISL28408](#) are single, dual and quad low power precision amplifiers optimized for single supply applications. These devices feature a common mode input voltage range extending to 0.5V below the V- rail, a rail-to-rail differential input voltage range for use as a comparator, and rail-to-rail output voltage swing, which make them ideal for single supply applications where input operation at ground is important.

Added features include low offset voltage, and low temperature drift making them the ideal choice for applications requiring high DC accuracy. The output stage is capable of driving large capacitive loads from rail-to-rail for excellent ADC driving performance. The devices can operate for single or dual supply from 3V ($\pm 1.5V$) to 40V ($\pm 20V$) and are fully characterized at $\pm 5V$ and $\pm 15V$. The combination of precision, low power, and small footprint provide the user with outstanding value and flexibility relative to similar competitive parts.

Applications for these amplifiers include precision instrumentation, data acquisition, precision power supply control, and industrial control.

The ISL28108 single is offered in 8 Ld TDFN, MSOP and SOIC packages. The ISL28208 dual amplifier is offered in 8 Ld TDFN, MSOP, and SOIC packages. The ISL28408 is offered in 14 Ld SOIC package. All devices are offered in standard pin configurations and operate across the extended temperature range of $-40^{\circ}C$ to $+125^{\circ}C$.

Features

- Single or dual supply, rail-to-rail output and below ground (V-) input capability
- Rail-to-rail input differential voltage range for comparator applications
- Single supply range 3V to 40V
- Low current consumption ($V_S = \pm 5V$) 165 μA
- Low noise voltage 15.8nV/ \sqrt{Hz}
- Low noise current 80fA/ \sqrt{Hz}
- Low input offset voltage (ISL28108) 150 μV
- Superb temperature drift
 - Voltage offset TC 0.1 $\mu V/^{\circ}C$, Typ
- Low input bias current -13nA Typ
- Operating temperature range $-40^{\circ}C$ to $+125^{\circ}C$
- No phase reversal

Applications

- Precision instruments
- Medical instrumentation
- Data acquisition
- Power supply control
- Industrial process control

Related Literature

For a full list of related documents, visit our website:

- [ISL28108](#), [ISL28208](#), and [ISL28408](#)



FIGURE 1. TYPICAL APPLICATION CIRCUIT



FIGURE 2. INPUT OFFSET VOLTAGE vs INPUT COMMON MODE VOLTAGE, $V_S = \pm 15V$

Table of Contents

| | |
|---|-----------|
| Ordering Information | 3 |
| Pin Configurations | 4 |
| Pin Descriptions | 5 |
| Absolute Maximum Ratings | 6 |
| Thermal Information | 6 |
| Operating Conditions | 6 |
| Electrical Specifications, $V_S \pm 15$ | 6 |
| Electrical Specifications, $V_S \pm 5V$ | 8 |
| Typical Performance Curves | 10 |
| Applications Information | 21 |
| Functional Description | 21 |
| Operating Voltage Range | 21 |
| Input Stage Performance | 21 |
| Output Drive Capability | 21 |
| Output Phase Reversal | 21 |
| Unused Channels | 22 |
| Power Dissipation | 22 |
| ISL28108, ISL28208, ISL28408 SPICE Model | 22 |
| Characterization vs Simulation Results | 25 |
| Revision History | 28 |
| Package Outline Drawings | 31 |

Ordering Information

| PART NUMBER (Notes 1, 2, 3) | PART MARKING | TEMP. RANGE (°C) | TAPE AND REEL (Units) (Note 1) | PACKAGE (RoHS Compliant) | PKG. DWG. # |
|--------------------------------|------------------|---------------------|-----------------------------------|-----------------------------|----------------|
| ISL28108FBZ | 28108 FBZ | -40 to +125 | - | 8 Ld SOIC | M8.15E |
| ISL28108FBZ-T7 | 28108 FBZ | -40 to +125 | 1k | 8 Ld SOIC | M8.15E |
| ISL28108FBZ-T7A | 28108 FBZ | -40 to +125 | 250 | 8 Ld SOIC | M8.15E |
| ISL28108FBZ-T13 | 28108 FBZ | -40 to +125 | 2.5k | 8 Ld SOIC | M8.15E |
| ISL28108FRTZ | 108Z | -40 to +125 | - | 8 Ld TDFN | L8.3x3K |
| ISL28108FRTZ-T7 | 108Z | -40 to +125 | 1k | 8 Ld TDFN | L8.3x3K |
| ISL28108FRTZ-T7A | 108Z | -40 to +125 | 250 | 8 Ld TDFN | L8.3x3K |
| ISL28108FRTZ-T13 | 108Z | -40 to +125 | 6k | 8 Ld TDFN | L8.3x3K |
| ISL28208FBZ | 28208 FBZ | -40 to +125 | - | 8 Ld SOIC | M8.15E |
| ISL28208FBZ-T7 | 28208 FBZ | -40 to +125 | 1k | 8 Ld SOIC | M8.15E |
| ISL28208FBZ-T7A | 28208 FBZ | -40 to +125 | 250 | 8 Ld SOIC | M8.15E |
| ISL28208FBZ-T13 | 28208 FBZ | -40 to +125 | 2.5k | 8 Ld SOIC | M8.15E |
| ISL28208FRTZ | 208F | -40 to +125 | - | 8 Ld TDFN | L8.3x3K |
| ISL28208FRTZ-T7 | 208F | -40 to +125 | 1k | 8 Ld TDFN | L8.3x3K |
| ISL28208FRTZ-T7A | 208F | -40 to +125 | 250 | 8 Ld TDFN | L8.3x3K |
| ISL28208FRTZ-T13 | 208F | -40 to +125 | 2.5k | 8 Ld TDFN | L8.3x3K |
| ISL28208FUZ | 8208Z | -40 to +125 | - | 8 Ld MSOP | M8.118B |
| ISL28208FUZ-T7 | 8208Z | -40 to +125 | 1k | 8 Ld MSOP | M8.118B |
| ISL28208FUZ-T7A | 8208Z | -40 to +125 | 250 | 8 Ld MSOP | M8.118B |
| ISL28208FUZ-T13 | 8208Z | -40 to +125 | 2.5k | 8 Ld MSOP | M8.118B |
| ISL28408FBZ | 28408 FBZ | -40 to +125 | - | 14 Ld SOIC | M14.15 |
| ISL28408FBZ-T7 | 28408 FBZ | -40 to +125 | 1k | 14 Ld SOIC | M14.15 |
| ISL28408FBZ-T7A | 28408 FBZ | -40 to +125 | 250 | 14 Ld SOIC | M14.15 |
| ISL28408FBZ-T13 | 28408 FBZ | -40 to +125 | 2.5k | 14 Ld SOIC | M14.15 |
| ISL28208SOICEVAL2Z | Evaluation Board | | | | |

NOTES:

1. See [TB347](#) for details about reel specifications.
2. These Pb-free plastic packaged products employ special Pb-free material sets, molding compounds/die attach materials, and 100% matte tin plate plus anneal (e3 termination finish, which is RoHS compliant and compatible with both SnPb and Pb-free soldering operations). Pb-free products are MSL classified at Pb-free peak reflow temperatures that meet or exceed the Pb-free requirements of IPC/JEDEC J STD-020.
3. For Moisture Sensitivity Level (MSL), see [ISL28108](#), [ISL28208](#), and [ISL28408](#) device pages. For more information about MSL, see [TB363](#).

Pin Configurations

ISL28108
(8 LD TDFN)
TOP VIEW



ISL28108
(8 LD MSOP, SOIC)
TOP VIEW

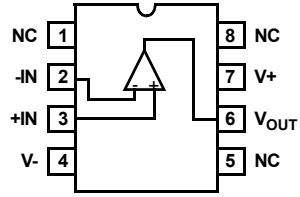

ISL28208
(8 LD TDFN)
TOP VIEW



ISL28208
(8 LD MSOP, SOIC)
TOP VIEW



ISL28408
(14 LD SOIC)
TOP VIEW



Pin Descriptions

| ISL28108 (8 Ld SOIC, MSOP, TDFN) | ISL28208 (8 Ld SOIC, MSOP, TDFN) | ISL28408 (14 Ld SOIC) | PIN NAME | EQUIVALENT CIRCUIT | DESCRIPTION |
|-------------------------------------|-------------------------------------|--------------------------|--------------------|--------------------|---|
| 3 | - | - | +IN | Circuit 1 | Amplifier non-inverting input |
| - | 3 | 3 | +IN_A | | |
| - | 5 | 5 | +IN_B | | |
| - | - | 10 | +IN_C | | |
| - | - | 12 | +IN_D | | |
| 4 | 4 | 11 | V- | Circuit 3 | Negative power supply |
| 2 | - | - | -IN | Circuit 1 | Amplifier inverting input |
| - | 2 | 2 | -IN_A | | |
| - | 6 | 6 | -IN_B | | |
| - | - | 9 | -IN_C | | |
| - | - | 13 | -IN_D | | |
| 7 | 8 | 4 | V+ | Circuit 3 | Positive power supply |
| 6 | - | - | V _{OUT} | Circuit 2 | Amplifier output |
| - | 1 | 1 | V _{OUT_A} | | |
| - | 7 | 7 | V _{OUT_B} | | |
| - | - | 8 | V _{OUT_C} | | |
| - | - | 14 | V _{OUT_D} | | |
| 1, 5, 8 | - | - | NC | - | No internal connection |
| PAD | PAD | - | PAD | - | Thermal Pad - TDFN package only. Connect thermal pad to ground or most negative potential. |



CIRCUIT 1



CIRCUIT 2



CIRCUIT 3

Absolute Maximum Ratings

| | |
|--|-------------------------------------|
| Maximum Supply Voltage | 42V |
| Maximum Differential Input Voltage | 42V or $V_- - 0.5V$ to $V_+ + 0.5V$ |
| Min/Max Input Voltage | 42V or $V_- - 0.5V$ to $V_+ + 0.5V$ |
| Max/Min Input Current | $\pm 20mA$ |
| Output Short-Circuit Duration (1 output at a time) | Indefinite |
| ESD Tolerance (ISL28208, ISL28408) | |
| Human Body Model (Tested per JESD22-A114F) | 6kV |
| Machine Model (Tested per JESD22-A115-C) | 400V |
| Charged Device Model (Tested per JESD22-C110D) | 2kV |
| ESD Tolerance (ISL28108) | |
| Human Body Model (Tested per JESD22-A114F) | 5.5kV |
| Machine Model (Tested per JESD22-A115-C) | 300V |
| Charged Device Model (Tested per JESD22-C110D) | 2kV |
| ESD Tolerance (ISL28108 MSOP package only) | |
| Human Body Model (Tested per JESD22-A114F) | 3kV |
| Machine Model (Tested per JESD22-A115-C) | 300V |
| Charged Device Model (Tested per JESD22-C110D) | 2kV |

CAUTION: Do not operate at or near the maximum ratings listed for extended periods of time. Exposure to such conditions can adversely impact product reliability and result in failures not covered by warranty.

NOTES:

- θ_{JA} is measured with the component mounted on a high effective thermal conductivity test board in free air. See [TB379](#) for details.
- θ_{JA} is measured in free air with the component mounted on a high effective thermal conductivity test board with direct attach features. See [TB379](#).
- For θ_{JC} , the case temperature location is the center of the exposed metal pad on the package underside.
- For θ_{JC} , the case temperature location is taken at the package top center.

IMPORTANT NOTE: All parameters having Min/Max specifications are guaranteed. Typical values are for information purposes only. Unless otherwise noted, all tests are at the specified temperature and are pulsed tests, therefore: $T_J = T_C = T_A$

Electrical Specifications, $V_S \pm 15$ $V_{CM} = 0, V_O = 0V, R_L = \text{Open}, T_A = +25^\circ C$, unless otherwise noted. **Boldface entries apply over the operating temperature range, $-40^\circ C$ to $+125^\circ C$. Temperature data established by characterization.**

| PARAMETER | DESCRIPTION | CONDITIONS | MIN (Note 8) | TYP | MAX (Note 8) | UNIT |
|-----------------|--|---|-----------------|-------------|-----------------|------------------|
| V_{OS} | Input Offset Voltage | ISL28208 | -230 | 25 | 230 | μV |
| | | ISL28408 | -330 | | 330 | μV |
| | | ISL28108 SOIC, TDFN | -150 | 10 | 150 | μV |
| | | | -270 | | 270 | μV |
| TCV_{OS} | Input Offset Voltage Temperature Coefficient | ISL28208 SOIC $-40^\circ C$ to $+125^\circ C$ | | 0.1 | 1.1 | $\mu V/^\circ C$ |
| | | ISL28208 MSOP $-40^\circ C$ to $+125^\circ C$ | | 0.2 | 1.5 | $\mu V/^\circ C$ |
| | | ISL28208 TDFN ISL28408 $-40^\circ C$ to $+125^\circ C$ | | 0.2 | 1.4 | $\mu V/^\circ C$ |
| | | ISL28108 SOIC, TDFN $-40^\circ C$ to $+125^\circ C$ | | 0.2 | 1.2 | $\mu V/^\circ C$ |
| ΔV_{OS} | Input Offset Voltage Match (ISL28208 only) | ISL28208 SOIC, TDFN | -300 | 5 | 300 | μV |
| | | | -400 | | 400 | μV |
| | | ISL28208 MSOP | -420 | | 420 | μV |
| I_B | Input Bias Current | | -43 | -13 | | nA |
| | | | -63 | | | nA |
| TCI_B | Input Bias Current Temperature Coefficient | | | 0.07 | | $nA/^\circ C$ |

Thermal Information

| | | |
|--------------------------------------|---------------------------------|--------------------------------|
| Thermal Resistance (Typical) | θ_{JA} ($^\circ C/W$) | θ_{JC} ($^\circ C/W$) |
| 8 Ld SOIC Package (208, Notes 4, 7) | 120 | 55 |
| 8 Ld SOIC Package (108, Notes 4, 7) | 120 | 60 |
| 8 Ld TDFN Package (208, Notes 5, 6) | 47 | 6 |
| 8 Ld TDFN Package (108, Notes 5, 6) | 45 | 3.5 |
| 8 Ld MSOP Package (208, Notes 4, 7) | 150 | 50 |
| 14 Ld SOIC Package (408, Notes 4, 7) | 71 | 37 |
| Storage Temperature Range | $-65^\circ C$ to $+150^\circ C$ | |
| Pb-Free Reflow Profile | see TB493 | |

Operating Conditions

| | |
|--|--|
| Ambient Operating Temperature Range | $-40^\circ C$ to $+125^\circ C$ |
| Maximum Operating Junction Temperature | $+150^\circ C$ |
| Supply Voltage | 3V ($\pm 1.5V$) to 40V ($\pm 20V$) |

Electrical Specifications, $V_S \pm 15$ $V_{CM} = 0, V_O = 0V, R_L = \text{Open}, T_A = +25^\circ\text{C}$, unless otherwise noted. **Boldface entries apply over the operating temperature range, -40°C to $+125^\circ\text{C}$. Temperature data established by characterization. (Continued)**

| PARAMETER | DESCRIPTION | CONDITIONS | MIN (Note 8) | TYP | MAX (Note 8) | UNIT |
|--------------|---|--|-------------------------|------------|-------------------------------|---------------|
| I_{OS} | Input Offset Current | ISL28208 | -3 | 0 | 3 | nA |
| | | | -4 | | 4 | nA |
| | | ISL28108 SOIC, TDFN ISL28408 | -4 | 0 | 4 | nA |
| | | | -5 | | 5 | nA |
| CMRR | Common-Mode Rejection Ratio | $V_{CM} = V_- - 0.5V$ to $V_+ - 1.8V$ | | 119 | | dB |
| | | $V_{CM} = V_- - 0.2V$ to $V_+ - 1.8V$ | | 123 | | dB |
| | | | | 102 | | dB |
| | | $V_{CM} = V_-$ to $V_+ - 1.8V$ | 105 | 123 | | dB |
| | | 102 | 115 | | dB | |
| V_{CMIR} | Common Mode Input Voltage Range | Guaranteed by CMRR test | $V_- - 0.5$ | | $V_+ - 1.8$ | V |
| | | | V_- | | $V_+ - 1.8$ | V |
| PSRR | Power Supply Rejection Ratio | $V_S = 3V$ to $40V, V_{CMIR} = \text{Valid Input Voltage}$ | 110 | 128 | | dB |
| | | | 109 | 124 | | dB |
| A_{VOL} | Open-Loop Gain | $V_O = -13V$ to $+13V, R_L = 10k\Omega$ to ground | 117 | 126 | | dB |
| | | | 100 | | | dB |
| V_{OL} | Output Voltage Low, V_{OUT} to V_- | $R_L = 10k\Omega$ | | 52 | 85 | mV |
| | | | | | 145 | mV |
| V_{OH} | Output Voltage High, V_+ to V_{OUT} | $R_L = 10k\Omega$ | | 70 | 110 | mV |
| | | | | | 150 | mV |
| I_S | Supply Current/Amplifier | $R_L = \text{Open}$ | | 185 | 250 | μA |
| | | | | 270 | 350 | μA |
| I_{SC+} | Output Short Circuit Source Current | $R_L = 10\Omega$ to V_- | | 19 | | mA |
| I_{SC-} | Output Short Circuit Sink Current | $R_L = 10\Omega$ to V_+ | | 30 | | mA |
| V_{SUPPLY} | Supply Voltage Range | Guaranteed by PSRR | 3 | | 40 | V |

AC SPECIFICATIONS

| | | | | | | |
|------------|-----------------------------------|--|--|---------|--|------------------------|
| GBWP | Gain Bandwidth Product | $A_{CL} = 101, V_O = 100mV_{P-P}, R_L = 2k\Omega$ | | 1.2 | | MHz |
| e_{np-p} | Noise Voltage | 0.1Hz to 10Hz; $V_S = \pm 18V$ | | 580 | | nV _{P-P} |
| e_n | Noise Voltage Density | $f = 10\text{Hz}; V_S = \pm 18V$ | | 18 | | nV/ $\sqrt{\text{Hz}}$ |
| e_n | Noise Voltage Density | $f = 100\text{Hz}; V_S = \pm 18V$ | | 16 | | nV/ $\sqrt{\text{Hz}}$ |
| e_n | Noise Voltage Density | $f = 1\text{kHz}; V_S = \pm 18V$ | | 15.8 | | nV/ $\sqrt{\text{Hz}}$ |
| e_n | Noise Voltage Density | $f = 10\text{kHz}; V_S = \pm 18V$ | | 15.8 | | nV/ $\sqrt{\text{Hz}}$ |
| i_n | Noise Current Density | $f = 10\text{kHz}; V_S = \pm 18V$ | | 80 | | fA/ $\sqrt{\text{Hz}}$ |
| THD + N | Total Harmonic Distortion + Noise | 1kHz, $A_V = 1, V_O = 3.5V_{RMS}, R_L = 10k\Omega$ | | 0.00042 | | % |

TRANSIENT RESPONSE

| | | | | | | |
|---------------------------|--|--|--|------|--|------------------|
| SR | Slew Rate, V_{OUT} 20% to 80% | $A_V = 1, R_L = 2k\Omega, V_O = 10V_{P-P}$ | | 0.45 | | V/ μs |
| t_r, t_f , Small Signal | Rise Time, V_{OUT} 10% to 90% | $A_V = 1, V_{OUT} = 100mV_{P-P}, R_f = 0\Omega, R_L = 2k\Omega$ to V_{CM} | | 264 | | ns |
| | Fall Time, V_{OUT} 90% to 10% | $A_V = 1, V_{OUT} = 100mV_{P-P}, R_f = 0\Omega, R_L = 2k\Omega$ to V_{CM} | | 254 | | ns |
| t_s | Settling Time to 0.01% 10V Step; 10% to V_{OUT} | $A_V = -1, V_{OUT} = 10V_{P-P}, R_g = R_f = 10k, R_L = 2k\Omega$ to V_{CM} | | 27 | | μs |

Electrical Specifications, $V_S \pm 5V$ $V_{CM} = 0, V_O = 0V, T_A = +25^\circ C$, unless otherwise noted. **Boldface entries apply over the operating temperature range, $-40^\circ C$ to $+125^\circ C$. Temperature data established by characterization.**

| PARAMETER | DESCRIPTION | CONDITIONS | MIN (Note 8) | TYP | MAX (Note 8) | UNIT |
|-----------------|---|---|-------------------------|---------------|-------------------------------|------------------|
| V_{OS} | Input Offset Voltage | ISL28208 ISL28408 | -230 | 25 | 230 | μV |
| | | | -330 | | 330 | μV |
| | | ISL28108 SOIC, TDFN | -150 | 10 | 150 | μV |
| | | | -270 | | 270 | μV |
| TCV_{OS} | Input Offset Voltage Temperature Coefficient | ISL28208 SOIC $-40^\circ C$ to $+125^\circ C$ | | 0.1 | 1.1 | $\mu V/^\circ C$ |
| | | ISL28208 MSOP $-40^\circ C$ to $+125^\circ C$ | | 0.2 | 1.5 | $\mu V/^\circ C$ |
| | | ISL28208 TDFN ISL28408 $-40^\circ C$ to $+125^\circ C$ | | 0.2 | 1.4 | $\mu V/^\circ C$ |
| | | ISL28108 SOIC, TDFN $-40^\circ C$ to $+125^\circ C$ | | 0.2 | 1.2 | $\mu V/^\circ C$ |
| ΔV_{OS} | Input Offset Voltage Match (ISL28208 only) | | -300 | 3 | 300 | μV |
| | | | -400 | | 400 | μV |
| I_B | Input Bias Current | | -43 | -15 | | nA |
| | | | -63 | | | nA |
| TCI_B | Input Bias Current Temperature Coefficient | $-40^\circ C$ to $+125^\circ C$ | | -0.067 | | nA/ $^\circ C$ |
| I_{OS} | Input Offset Current | ISL28208 | -3 | 0 | 3 | nA |
| | | | -4 | | 4 | nA |
| | | ISL28108 SOIC, TDFN ISL28408 | -4 | 0 | 4 | nA |
| | | | -5 | | 5 | nA |
| CMRR | Common-Mode Rejection Ratio | $V_{CM} = V_- - 0.5V$ to $V_+ - 1.8V$ | | 101 | | dB |
| | | | | 123 | | dB |
| | | | | 89 | | dB |
| | | $V_{CM} = V_-$ to $V_+ - 1.8V$ ISL28108, ISL28208 | 105 | 123 | | dB |
| | | | 100 | 112 | | dB |
| | | | 105 | 123 | | dB |
| V_{CMIR} | Common Mode Input Voltage Range | Guaranteed by CMRR test | $V_- - 0.5$ | | $V_+ - 1.8$ | V |
| | | | V_- | | $V_+ - 1.8$ | V |
| PSRR | Power Supply Rejection Ratio | $V_S = 3V$ to $10V, V_{CMIR} =$ Valid Input Voltage All except ISL28208 MSOP | 110 | 126 | | dB |
| | | | 109 | 123 | | dB |
| | | ISL28208 MSOP $V_S = 3V$ to $10V, V_{CMIR} =$ Valid Input Voltage | 109 | 126 | | dB |
| | | | 107 | 123 | | dB |
| A_{VOL} | Open-Loop Gain | $V_O = -3V$ to $+3V, R_L = 10k\Omega$ to ground | 117 | 124 | | dB |
| | | | 99 | | | dB |
| V_{OL} | Output Voltage Low, V_{OUT} to V_- | $R_L = 10k\Omega$ | | 23 | 38 | mV |
| | | | | | 48 | mV |
| V_{OH} | Output Voltage High, V_+ to V_{OUT} | $R_L = 10k\Omega$ | | 30 | 65 | mV |
| | | | | | 70 | mV |

Electrical Specifications, $V_S \pm 5V$ $V_{CM} = 0, V_O = 0V, T_A = +25^\circ C$, unless otherwise noted. **Boldface entries apply over the operating temperature range, $-40^\circ C$ to $+125^\circ C$. Temperature data established by characterization. (Continued)**

| PARAMETER | DESCRIPTION | CONDITIONS | MIN (Note 8) | TYP | MAX (Note 8) | UNIT |
|---------------------------|--|---|-----------------|------------|-----------------|------------------------|
| I_S | Supply Current/Amplifier | $R_L = \text{Open}$ | | 165 | 250 | μA |
| | | | | 240 | 350 | μA |
| I_{SC+} | Output Short Circuit Source Current | $R_L = 10\Omega$ to V_- | | 14 | | mA |
| I_{SC-} | Output Short Circuit Sink Current | $R_L = 10\Omega$ to V_+ | | 22 | | mA |
| AC SPECIFICATIONS | | | | | | |
| GBW | Gain Bandwidth Product | $A_{CL} = 101, V_O = 100mV_{P-P}, R_L = 2k\Omega$ | | 1.2 | | MHz |
| e_{np-p} | Noise Voltage | 0.1Hz to 10Hz | | 600 | | nV _{P-P} |
| e_n | Noise Voltage Density | $f = 10\text{Hz}$ | | 18 | | nV/ $\sqrt{\text{Hz}}$ |
| e_n | Noise Voltage Density | $f = 100\text{Hz}$ | | 16 | | nV/ $\sqrt{\text{Hz}}$ |
| e_n | Noise Voltage Density | $f = 1\text{kHz}$ | | 15.8 | | nV/ $\sqrt{\text{Hz}}$ |
| e_n | Noise Voltage Density | $f = 10\text{kHz}$ | | 15.8 | | nV/ $\sqrt{\text{Hz}}$ |
| i_n | Noise Current Density | $f = 10\text{kHz}$ | | 90 | | fA/ $\sqrt{\text{Hz}}$ |
| TRANSIENT RESPONSE | | | | | | |
| SR | Slew Rate, V_{OUT} 20% to 80% | $A_V = 1, R_L = 2k\Omega, V_O = 4V_{P-P}$ | | 0.4 | | V/ μs |
| t_r, t_f , Small Signal | Rise Time, V_{OUT} 10% to 90% | $A_V = 1, V_{OUT} = 100mV_{P-P}, R_f = 0\Omega, R_L = 2k\Omega$ to V_{CM} | | 264 | | ns |
| | Fall Time, V_{OUT} 90% to 10% | $A_V = 1, V_{OUT} = 100mV_{P-P}, R_f = 0\Omega, R_L = 2k\Omega$ to V_{CM} | | 254 | | ns |
| t_s | Settling Time to 0.01% 4V Step; 10% to V_{OUT} | $A_V = -1, V_{OUT} = 4V_{P-P}, R_g = R_f = 10k, R_L = 2k\Omega$ to V_{CM} | | 14.4 | | μs |

NOTE:

8. Compliance to data sheet limits is assured by one or more methods: production test, characterization and/or design.

Typical Performance Curves

$V_S = \pm 15V$, $V_{CM} = 0V$, $R_L = \text{Open}$, $T_A = +25^\circ C$, unless otherwise specified.



FIGURE 3. ISL28408 SOIC INPUT OFFSET VOLTAGE DISTRIBUTION, $V_S = \pm 15V$



FIGURE 4. ISL28408 SOIC INPUT OFFSET VOLTAGE DISTRIBUTION, $V_S = \pm 5V$



FIGURE 5. ISL28208 INPUT OFFSET VOLTAGE DISTRIBUTION, $V_S = \pm 15V$



FIGURE 6. ISL28208 INPUT OFFSET VOLTAGE DISTRIBUTION, $V_S = \pm 5V$



FIGURE 7. ISL28108 SOIC INPUT OFFSET VOLTAGE DISTRIBUTION, $V_S = \pm 15V$



FIGURE 8. ISL28108 SOIC INPUT OFFSET VOLTAGE DISTRIBUTION, $V_S = \pm 5V$

Typical Performance Curves

$V_S = \pm 15V$, $V_{CM} = 0V$, $R_L = \text{Open}$, $T_A = +25^\circ C$, unless otherwise specified. (Continued)



FIGURE 9. ISL28108 TDFN INPUT OFFSET VOLTAGE DISTRIBUTION, $V_S = \pm 15V$



FIGURE 10. ISL28108 TDFN INPUT OFFSET VOLTAGE DISTRIBUTION, $V_S = \pm 5V$

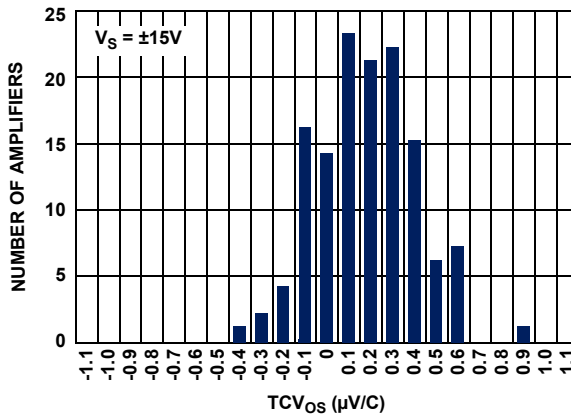

FIGURE 11. ISL28408 SOIC TCV_{OS} vs NUMBER OF AMPLIFIERS, $V_S = \pm 15V$

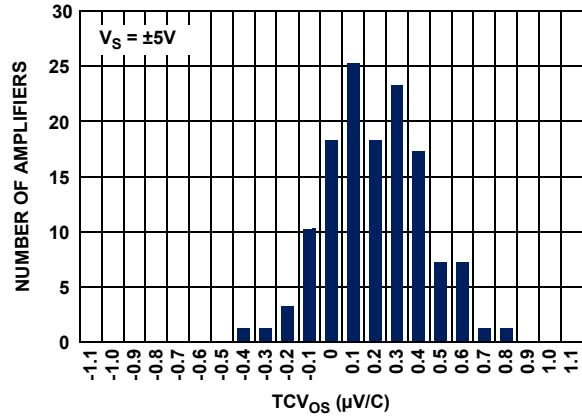

FIGURE 12. ISL28408 SOIC TCV_{OS} vs NUMBER OF AMPLIFIERS, $V_S = \pm 5V$

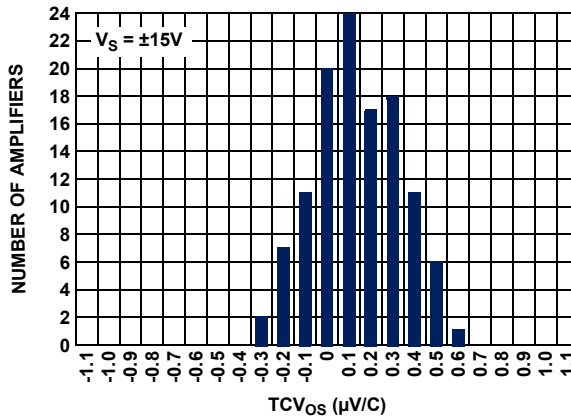

FIGURE 13. ISL28208 SOIC TCV_{OS} vs NUMBER OF AMPLIFIERS, $V_S = \pm 15V$

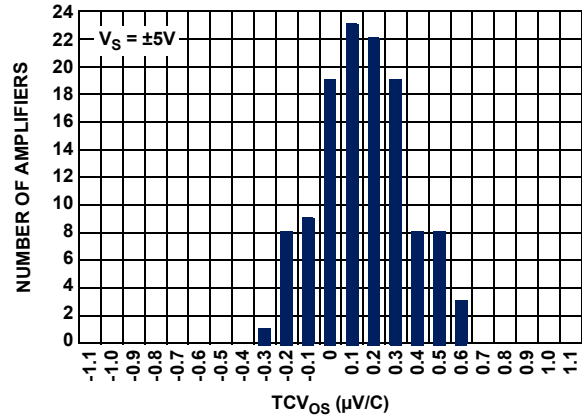

FIGURE 14. ISL28208 SOIC TCV_{OS} vs NUMBER OF AMPLIFIERS, $V_S = \pm 5V$

Typical Performance Curves

$V_S = \pm 15V$, $V_{CM} = 0V$, $R_L = \text{Open}$, $T_A = +25^\circ C$, unless otherwise specified. (Continued)



FIGURE 15. ISL28208 TDFN AND MSOP TCV_{OS} vs NUMBER OF AMPLIFIERS, $V_S = \pm 15V$



FIGURE 16. ISL28208 TDFN AND MSOP TCV_{OS} vs NUMBER OF AMPLIFIERS, $V_S = \pm 5V$

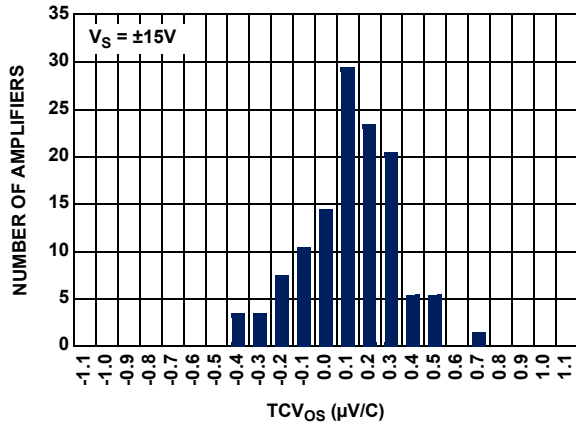

FIGURE 17. ISL28108 SOIC TCV_{OS} vs NUMBER OF AMPLIFIERS, $V_S = \pm 15V$

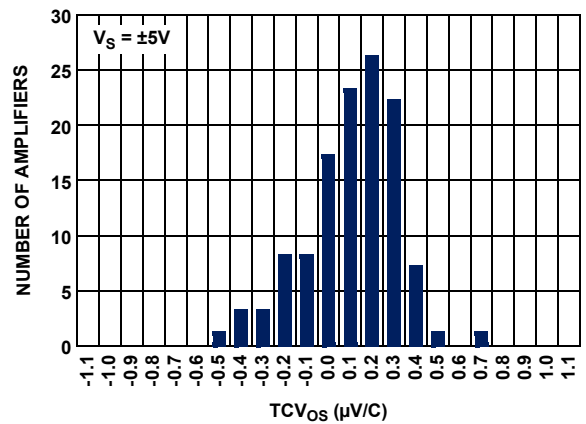

FIGURE 18. ISL28108 SOIC TCV_{OS} vs NUMBER OF AMPLIFIERS, $V_S = \pm 5V$

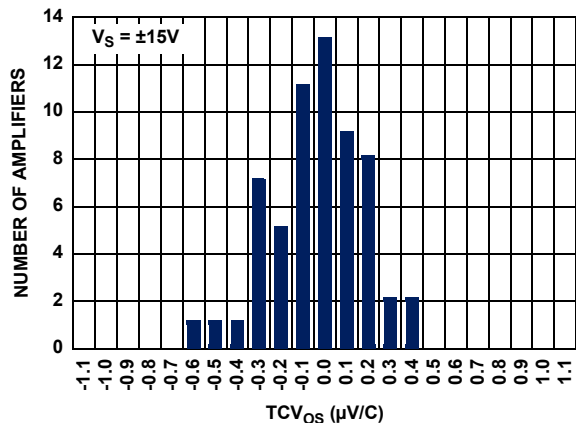

FIGURE 19. ISL28108 TDFN TCV_{OS} vs NUMBER OF AMPLIFIERS, $V_S = \pm 15V$

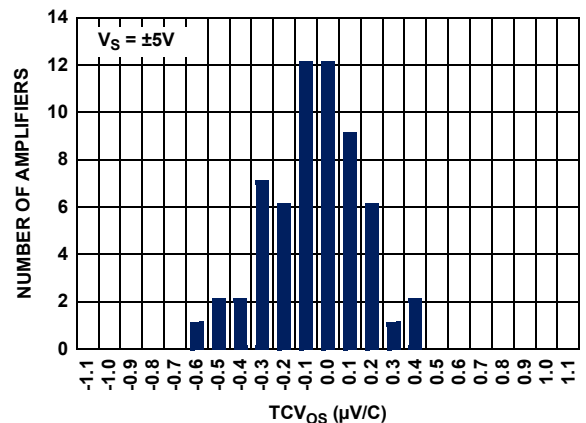

FIGURE 20. ISL28108 TDFN TCV_{OS} vs NUMBER OF AMPLIFIERS, $V_S = \pm 5V$

Typical Performance Curves $V_S = \pm 15V, V_{CM} = 0V, R_L = \text{Open}, T_A = +25^\circ C$, unless otherwise specified. (Continued)



FIGURE 21. V_{OS} vs TEMPERATURE



FIGURE 22. I_{BIAS} vs TEMPERATURE vs SUPPLY

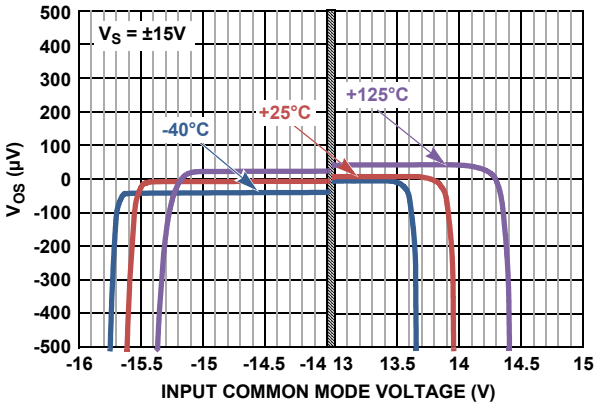

FIGURE 23. INPUT OFFSET VOLTAGE vs INPUT COMMON MODE VOLTAGE, $V_S = \pm 15V$



FIGURE 24. INPUT OFFSET VOLTAGE vs INPUT COMMON MODE VOLTAGE, $V_S = \pm 5V$



FIGURE 25. CMRR vs TEMPERATURE, $V_S = \pm 15V$



FIGURE 26. CMRR vs TEMPERATURE, $V_S = \pm 5V$

Typical Performance Curves $V_S = \pm 15V$, $V_{CM} = 0V$, $R_L = \text{Open}$, $T_A = +25^\circ C$, unless otherwise specified. (Continued)



FIGURE 27. CMRR vs FREQUENCY, $V_S = \pm 15V$



FIGURE 28. PSRR vs FREQUENCY, $V_S = \pm 5V$ AND $\pm 15V$



FIGURE 29. PSRR (DC) vs TEMPERATURE, $V_S = \pm 15V$



FIGURE 30. PSRR (DC) vs TEMPERATURE, $V_S = \pm 5V$



FIGURE 31. OUTPUT OVERHEAD VOLTAGE HIGH vs LOAD CURRENT, $V_S = \pm 5V$ AND $\pm 15V$



FIGURE 32. OUTPUT OVERHEAD VOLTAGE LOW vs LOAD CURRENT, $V_S = \pm 5V$ AND $\pm 15V$

Typical Performance Curves

$V_S = \pm 15V, V_{CM} = 0V, R_L = \text{Open}, T_A = +25^\circ C$, unless otherwise specified. (Continued)



FIGURE 33. ISL28208 OUTPUT VOLTAGE SWING vs LOAD CURRENT
 $V_S = \pm 15V$

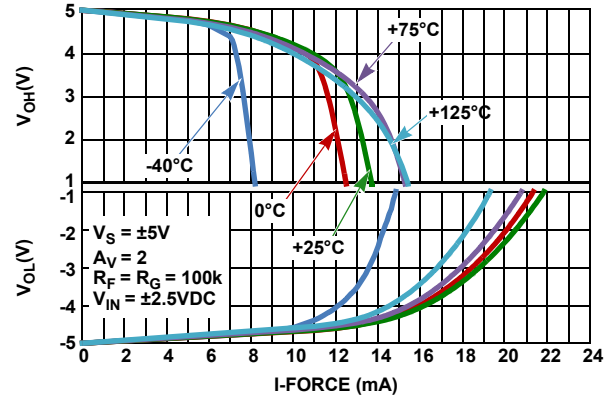

FIGURE 34. ISL28208 OUTPUT VOLTAGE SWING vs LOAD CURRENT
 $V_S = \pm 5V$



FIGURE 35. V_{OUT} HIGH AND LOW vs TEMPERATURE,
 $V_S = \pm 15V, R_L = 10k$



FIGURE 36. V_{OUT} HIGH AND LOW vs TEMPERATURE,
 $V_S = \pm 5V, R_L = 10k$

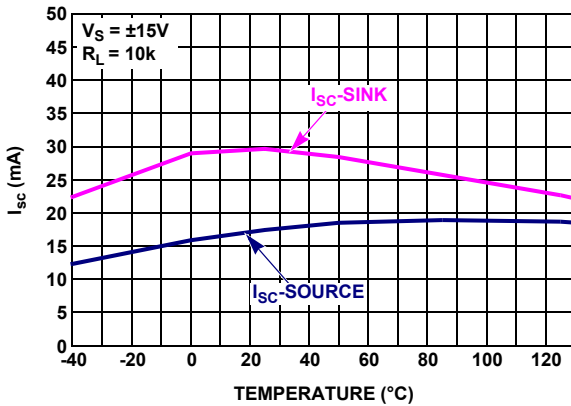

FIGURE 37. SHORT CIRCUIT CURRENT vs TEMPERATURE, $V_S = \pm 15V$

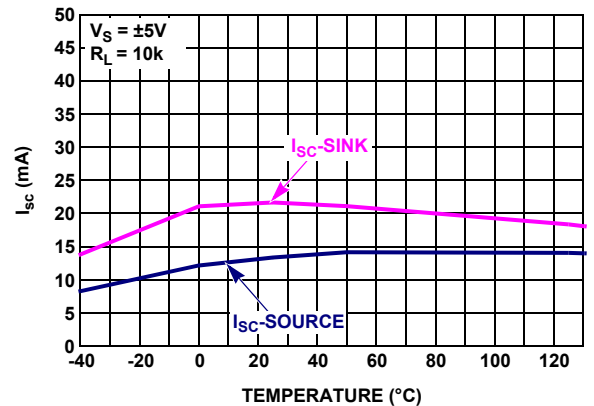

FIGURE 38. SHORT CIRCUIT CURRENT vs TEMPERATURE, $V_S = \pm 5V$

Typical Performance Curves

$V_S = \pm 15V$, $V_{CM} = 0V$, $R_L = \text{Open}$, $T_A = +25^\circ C$, unless otherwise specified. (Continued)

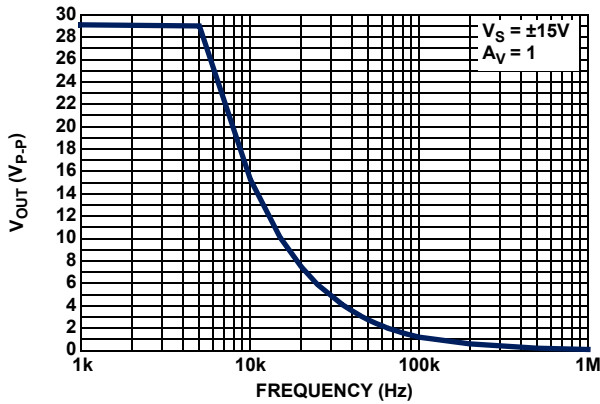

FIGURE 39. MAX OUTPUT VOLTAGE vs FREQUENCY

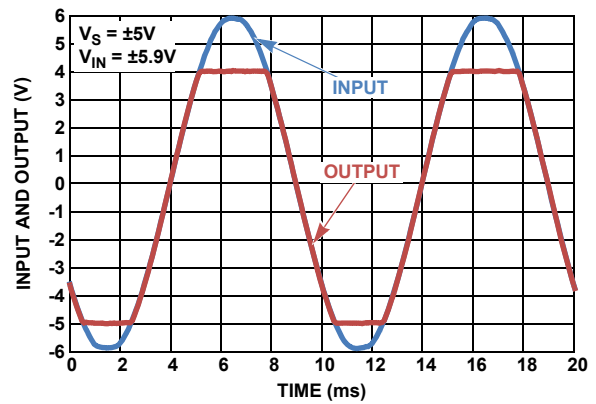

FIGURE 40. NO PHASE REVERSAL

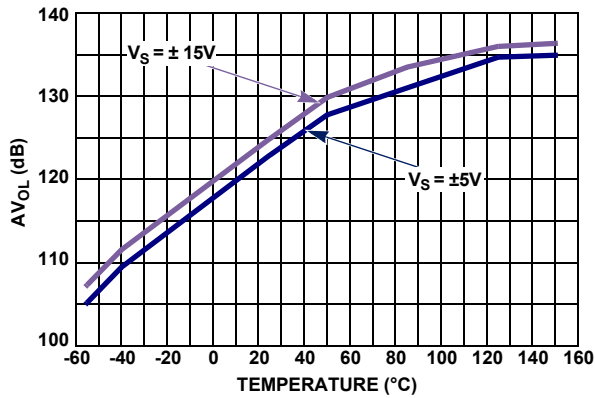

FIGURE 41. $A_{V_{OL}}$ vs TEMPERATURE

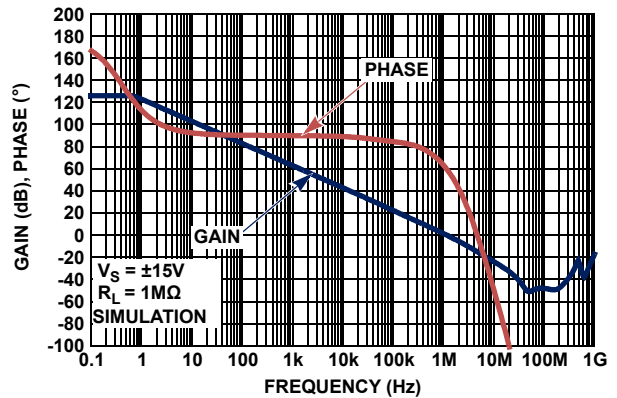

FIGURE 42. OPEN-LOOP GAIN, PHASE vs FREQUENCY, $V_S = \pm 15V$

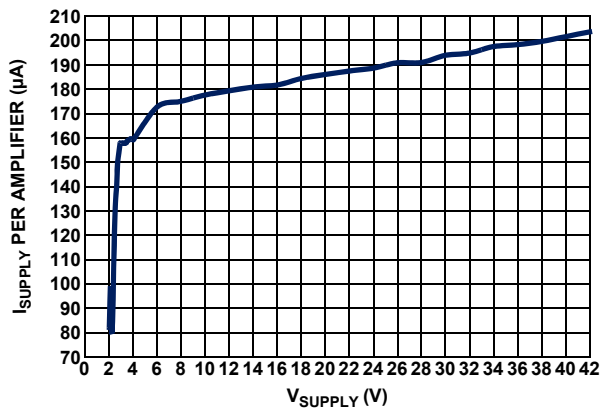

FIGURE 43. SUPPLY CURRENT vs SUPPLY VOLTAGE

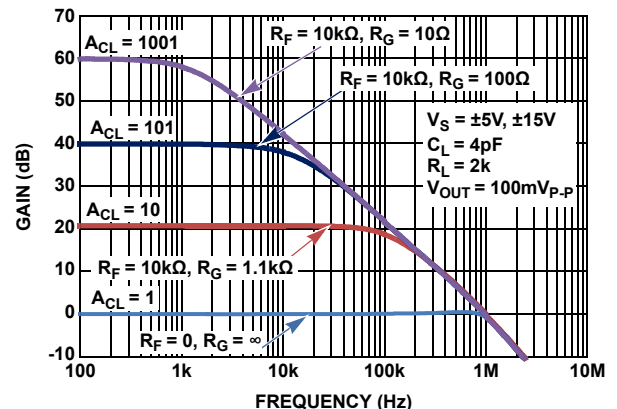

FIGURE 44. FREQUENCY RESPONSE vs CLOSED LOOP GAIN

Typical Performance Curves

$V_S = \pm 15V$, $V_{CM} = 0V$, $R_L = \text{Open}$, $T_A = +25^\circ C$, unless otherwise specified. (Continued)



FIGURE 45. GAIN vs FREQUENCY vs R_L , $V_S = \pm 15V$



FIGURE 46. GAIN vs FREQUENCY vs R_L , $V_S = \pm 5V$



FIGURE 47. GAIN vs FREQUENCY vs OUTPUT VOLTAGE

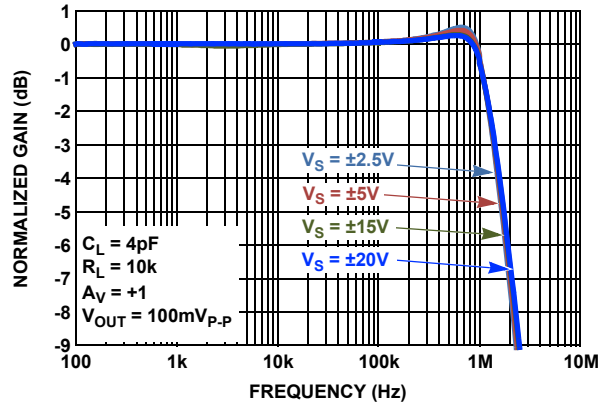

FIGURE 48. GAIN vs FREQUENCY vs SUPPLY VOLTAGE



FIGURE 49. OUTPUT IMPEDANCE vs FREQUENCY, $V_S = \pm 15V$



FIGURE 50. OUTPUT IMPEDANCE vs FREQUENCY, $V_S = \pm 5V$

Typical Performance Curves

$V_S = \pm 15V, V_{CM} = 0V, R_L = \text{Open}, T_A = +25^\circ C$, unless otherwise specified. (Continued)



FIGURE 51. INPUT NOISE VOLTAGE (en) AND CURRENT (in) vs FREQUENCY, $V_S = \pm 18V$



FIGURE 52. INPUT NOISE VOLTAGE (en) AND CURRENT (in) vs FREQUENCY, $V_S = \pm 5V$



FIGURE 53. INPUT NOISE VOLTAGE 0.1Hz TO 10Hz, $V_S = \pm 18V$



FIGURE 54. INPUT NOISE VOLTAGE 0.1Hz TO 10Hz, $V_S = \pm 5V$



FIGURE 55. ISL28208 CHANNEL SEPARATION vs FREQUENCY, $V_S = \pm 5V, \pm 15V$



FIGURE 56. POSITIVE OUTPUT OVERLOAD RESPONSE TIME, $V_S = \pm 15V$

Typical Performance Curves

$V_S = \pm 15V$, $V_{CM} = 0V$, $R_L = \text{Open}$, $T_A = +25^\circ C$, unless otherwise specified. (Continued)



FIGURE 57. NEGATIVE OUTPUT OVERLOAD RESPONSE TIME, $V_S = \pm 15V$



FIGURE 58. POSITIVE OUTPUT OVERLOAD RESPONSE TIME, $V_S = \pm 5V$



FIGURE 59. NEGATIVE OUTPUT OVERLOAD RESPONSE TIME, $V_S = \pm 5V$



FIGURE 60. OVERSHOOT vs CAPACITIVE LOAD, $V_S = \pm 15V$

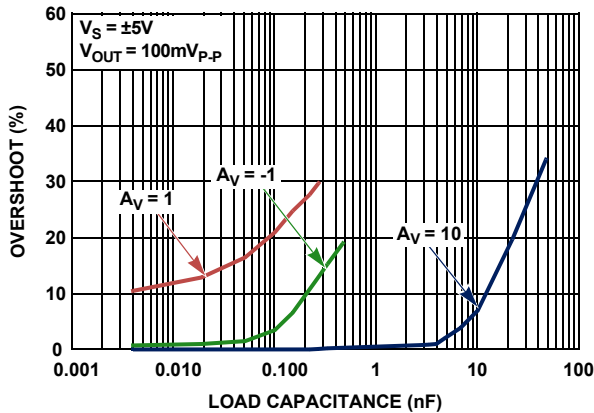

FIGURE 61. OVERSHOOT vs CAPACITIVE LOAD, $V_S = \pm 5V$



FIGURE 62. LARGE SIGNAL 10V STEP RESPONSE, $V_S = \pm 15V$

Typical Performance Curves $V_S = \pm 15V$, $V_{CM} = 0V$, $R_L = \text{Open}$, $T_A = +25^\circ C$, unless otherwise specified. (Continued)



FIGURE 63. LARGE SIGNAL 4V STEP RESPONSE, $V_S = \pm 5V$



FIGURE 64. SMALL SIGNAL TRANSIENT RESPONSE $V_S = \pm 5V, \pm 15V$

Applications Information

Functional Description

The ISL28108, ISL28208, and ISL28408 are single, dual and quad, 1.2MHz, single supply rail-to-rail output amplifiers with a common mode input voltage range extending to a range of 0.5V below the V- rail. Their input stages are optimized for precision sensing of ground referenced signals in low voltage, single supply applications. The input stage has the capability of handling large input differential voltages without phase inversion making them suitable for high voltage comparator applications. Their bipolar design features high open loop gain and excellent DC input and output temperature stability. These op amps feature low quiescent current of 165 μ A, and a maximum temperature drift ranging from 1.1 μ V/ $^{\circ}$ C for the ISL28208 and ISL28408 in the SOIC package to 1.4 μ V/ $^{\circ}$ C for the ISL28208 in the TDFN package and the ISL28408 in the SOIC package (see Figures 11 through 20). All devices are fabricated in a new precision 40V complementary bipolar DI process and immune from latch-up.

Operating Voltage Range

The devices are designed to operate over the 3V (± 1.5 V) to 40V (± 20 V) range and are fully characterized at ± 5 V and ± 15 V. Both DC and AC performance remain virtually unchanged over the ± 5 V to ± 15 V operating voltage range. Parameter variation with operating voltage is shown in the "Typical Performance Curves" beginning on page 10.

Input Stage Performance

The PNP input stage has a common mode input range extending up to 0.5V below ground at +25 $^{\circ}$ C (see Figures 23 and 24). Full amplifier performance is guaranteed down to ground (V-) over the -40 $^{\circ}$ C to +125 $^{\circ}$ C temperature range. For common mode voltages down to -0.5V the amplifiers are fully functional, but performance degrades slightly over the full temperature range. This feature provides excellent CMRR, AC performance and DC accuracy when amplifying low level ground referenced signals.

The input stage has a maximum input differential voltage equal to a diode drop greater than the supply voltage (max 42V) and does not contain the back-to-back input protection diodes found on many similar amplifiers. This feature enables the device to function as a precision comparator by maintaining very high input impedance for high voltage differential input comparator voltages. The high differential input impedance also enables the device to operate reliably in large signal pulse applications without the need for anti-parallel clamp diodes required on MOSFET and most bipolar input stage op amps. Thus, input signal distortion caused by nonlinear clamps under high slew rate conditions are avoided.

In applications where one or both amplifier input terminals are at risk of exposure to voltages beyond the supply rails, current limiting resistors may be needed at each input terminal (see Figure 65, R_{IN+} , R_{IN-}) to limit current through the power supply ESD diodes to 20mA.



FIGURE 65. INPUT ESD DIODE CURRENT LIMITING

Output Drive Capability

The bipolar rail-to-rail output stage features low saturation levels that enable an output voltage swing to less than 10mV when the total output load (including feedback resistance) is held below 50 μ A (Figures 31 and 32). With ± 15 V supplies this can be achieved by using feedback resistor values >300 k Ω . The low input bias and offset currents (-43nA and ± 3 nA +25 $^{\circ}$ C max respectively) minimize DC offset errors at these high resistance values. For example, a balanced 4 resistor gain circuit (Figure 65) with 1M Ω feedback resistors (R_F , R_G) generates a worst case input offset error of only ± 3 mV. Furthermore, the low noise current reduces the added noise associated with high feedback resistance.

The output stage is internally current limited. Output current limit over-temperature is shown in Figures 37 and 38. The amplifiers can withstand a short circuit to either rail as long as the power dissipation limits are not exceeded. This applies to only one amplifier at a time for the dual op amp. Continuous operation under these conditions may degrade long-term reliability.

The amplifiers perform well driving capacitive loads (Figures 60 and 61). The unity gain, voltage follower (buffer) configuration provides the highest bandwidth, but is also the most sensitive to ringing produced by load capacitance found in BNC cables. Unity gain overshoot is limited to 30% at capacitance values to 0.33nF. At gains of 10 and higher, the device is capable of driving more than 10nF without significant overshoot.

Output Phase Reversal

Output phase reversal is a change of polarity in the amplifier transfer function when the input voltage exceeds the supply voltage. These devices are immune to output phase reversal, out to 0.5V beyond the rail ($V_{ABS\ MAX}$) limit (see Figure 40).

Unused Channels

If the application requires only one channel, the user must configure any unused channel to prevent it from oscillating. Unused channels can oscillate if the input and output pins are floating. This will result in higher-than-expected supply currents and possible noise injection into the channel being used. The proper way to prevent oscillation is to short the output to the inverting input, and ground the positive input (Figure 66).



FIGURE 66. PREVENTING OSCILLATIONS IN UNUSED CHANNELS

Power Dissipation

It is possible to exceed the +150°C maximum junction temperatures under certain load and power supply conditions. It is therefore important to calculate the maximum junction temperature (T_{JMAX}) for all applications to determine if power supply voltages, load conditions, or package type need to be modified to remain in the safe operating area. These parameters are related using Equation 1:

$$T_{JMAX} = T_{MAX} + \theta_{JA} \times PD_{MAXTOTAL} \quad (EQ. 1)$$

where:

- $PD_{MAXTOTAL}$ is the sum of the maximum power dissipation of each amplifier in the package (PD_{MAX})
- PD_{MAX} for each amplifier can be calculated using Equation 2:

$$PD_{MAX} = V_S \times I_{qMAX} + (V_S - V_{OUTMAX}) \times \frac{V_{OUTMAX}}{R_L} \quad (EQ. 2)$$

where:

- T_{MAX} = Maximum ambient temperature
- θ_{JA} = Thermal resistance of the package
- PD_{MAX} = Maximum power dissipation of 1 amplifier
- V_S = Total supply voltage
- I_{qMAX} = Maximum quiescent supply current of 1 amplifier
- V_{OUTMAX} = Maximum output voltage swing of the application
- R_L = Load resistance

ISL28108, ISL28208, ISL28408 SPICE Model

Figure 67 shows the SPICE model schematic and Figure 68 shows the net list for the SPICE model. The model is a simplified version of the actual device and simulates important AC and DC parameters. AC parameters incorporated into the model are: 1/f and flat band noise voltage, Slew Rate, CMRR, Gain and Phase. The DC parameters are I_{OS} , total supply current and output voltage swing. The model uses typical parameters given in the “Electrical Specifications” Table beginning on page 6. The AVOL is adjusted for 122dB with the dominant pole at 1Hz. The CMRR is set 128dB, $f = 6$ kHz. The input stage models the actual device to present an accurate AC representation. The model is configured for ambient temperature of +25°C.

Figures 69 through 83 show the characterization vs simulation results for the Noise Voltage, Open Loop Gain Phase, Closed Loop Gain vs Frequency, Gain vs Frequency vs R_L , CMRR, Large Signal 10V Step Response, Small Signal 0.05V Step and Output Voltage Swing ± 15 V supplies.

LICENSE STATEMENT

The information in this SPICE model is protected under the United States copyright laws. Intersil Corporation hereby grants users of this macro-model hereto referred to as “Licensee”, a nonexclusive, nontransferable licence to use this model as long as the Licensee abides by the terms of this agreement. Before using this macro-model, the Licensee should read this license. If the Licensee does not accept these terms, permission to use the model is not granted.

The Licensee may not sell, loan, rent, or license the macro-model, in whole, in part, or in modified form, to anyone outside the Licensee’s company. The Licensee may modify the macro-model to suit his/her specific applications, and the Licensee may make copies of this macro-model for use within their company only.

This macro-model is provided “AS IS, WHERE IS, AND WITH NO WARRANTY OF ANY KIND EITHER EXPRESSED OR IMPLIED, INCLUDING, BUT NOT LIMITED TO, ANY IMPLIED WARRANTIES OF MERCHANTABILITY AND FITNESS FOR A PARTICULAR PURPOSE.”

In no event will Intersil be liable for special, collateral, incidental, or consequential damages in connection with or arising out of the use of this macro-model. Intersil reserves the right to make changes to the product and the macro-model without prior notice.



FIGURE 67. SPICE MODEL SCHEMATIC

```
*ISL28108_208 Macromodel - covers following
*products
*ISL28108
*ISL28208
*ISL28408
*
*Revision History:
* Revision B, LaFontaine January 22 2014
* Model for Noise, supply currents, CMRR
*128dB f=6kHz, AVOL 122dB f=1Hz
* SR = 0.45V/us, GBWP 1.2MHz.
*Copyright 2011 by Intersil Corporation
*Refer to data sheet "LICENSE STATEMENT"
*Use of this model indicates your acceptance
*with the terms and provisions in the License
*Statement.
*
*Intended use:
*This Pspice Macromodel is intended to give
*typical DC and AC performance characteristics
*under a wide range of external circuit
*configurations using compatible simulation
*platforms – such as iSim PE.
*
*Device performance features supported by this
*model
*Typical, room temp., nominal power supply
*voltages used to produce the following
*characteristics:
*Open and closed loop I/O impedances,
*Open loop gain and phase,
*Closed loop bandwidth and frequency
*response,
*Loading effects on closed loop frequency
*response,
*Input noise terms including 1/f effects,
*Slew rate,
*Input and Output Headroom limits to I/O
*voltage swing,
*Supply current at nominal specified supply
*voltages.
*
*Device performance features NOT supported
*by this model:
*Harmonic distortion effects,
*Output current limiting (current will limit at
*40mA),
*Disable operation (if any),
*Thermal effects and/or over temperature
*parameter variation,
*Limited performance variation vs. supply
*voltage is modeled,
*Part to part performance variation due to
*normal process parameter spread,
*Any performance difference arising from
*different packaging source,
*Load current reflected into the power supply
*current.
*
* Connections:          +input
*                       |
*                       | -input
*                       | |
*                       | | +Vsupply
*                       | | |
*                       | | | -Vsupply
*                       | | |
*                       | | | output
*                       | | |
*                       | | |
*
*subckt ISL28108_208 Vin+ Vin-V+ V- VOUT
* source ISL28118_218_subckt_check_0
*
*Voltage Noise
E_En    VIN+ 6 2 0 0.3
D_D13  1 2 DN
D_D14  1 2 DN
V_V7   1 0 0.1
R_R17   2 0 1150
*
*Input Stage
Q_Q6    11 10 9 PNP_input
Q_Q7    8 7 9 PNP_input
Q_Q8    V- VIN- 7 PNP_LATERAL
Q_Q9    V- 12 10 PNP_LATERAL
L_L1    V++ 9 DC 12e-6
L_L2    V++ 7 DC 6E-6
L_L3    V++ 10 DC 6E-6
L_IOS   6 VIN- DC 3e-9
D_D1    7 10 DBREAK
D_D2    10 7 DBREAK
R_R1    5 6 5e11
R_R2    VIN- 5 5e11
R_R3    V- 8 6250
R_R4    V- 11 6250
C_Cin1  V- VIN- 4.19e-12
C_Cin2  V- 6 4.19e-12
C_CinDif 6 VIN- 1.21E-12
*
*1st Gain Stage
G_G1    V++ 14 8 11 0.4779867
G_G2    V- 14 8 11 0.4779867
V_V1    13 14 -6.74
V_V2    14 15 -6.76
D_D3    13 V++ DX
D_D4    V- 15 DX
R_R5    14 V++ 1
R_R6    V- 14 1
*
*2nd Gain Stage
G_G3    V++ VG 14 VMID 261.748e-6
G_G4    V- VG 14 VMID 261.748e-6
V_V3    16 VG -6.74
V_V4    VG 17 -6.76
D_D5    16 V++ DX
D_D6    V- 17 DX
R_R7    VG V++ 7.62283e9
R_R8    V- VG 7.62283e9
C_C1    VG V++ 2.31e-11
C_C2    V- VG 2.31e-11
*
*Mid supply Ref
E_E2    V++ 0 V+ 0 1
E_E3    V- 0 V- 0 1
E_E4    VMID V- V++ V- 0.5
L_ISY   V+ V- DC 185E-6
*
*Common Mode Gain Stage with Zero
G_G5    V++ 19 5 VMID 0.6
G_G6    V- 19 5 VMID 0.6
G_G7    V++ VC 19 VMID 0.6
G_G8    V- VC 19 VMID 0.6
E_EOS   12 6 VC VMID 1
L_L1    18 V++ 1.59159E-08
L_L2    20 V- 1.59159E-08
L_L3    21 V++ 1.59159E-08
L_L4    22 V- 1.59159E-08
R_R9    19 18 1e-3
R_R10   20 19 1e-3
R_R11   VC 21 1e-3
R_R12   22 VC 1e-3
*
*Pole Stage
G_G15   V++ 28 VG VMID 314.15e-6
G_G16   V- 28 VG VMID 314.15e-6
R_R19   28 V++ 3.18319e3
R_R20   V- 28 3.18319e3
C_C5    28 V++ 10e-12
C_C6    V- 28 10e-12
*
G_G9    V++ 23 28 VMID 314.15e-6
G_G10   V- 23 28 VMID 314.15e-6
R_R13   23 V++ 3.18319e3
R_R14   V- 23 3.18319e3
C_C3    23 V++ 10e-12
C_C4    V- 23 10e-12
*
*Output Stage with Correction Current Sources
G_G11   26 V- VOUT 23 12.5e-3
G_G12   27 V- 23 VOUT 12.5e-3
G_G13   VOUT V++ V++ 23 12.5e-3
G_G14   V- VOUT 23 V- 12.5e-3
D_D7    23 24 DX
D_D8    25 23 DX
D_D9    V- 26 DY
D_D10   V++ 26 DX
D_D11   V++ 27 DX
D_D12   V- 27 DY
V_V5    24 VOUT -0.4
V_V6    VOUT 25 -0.4
R_R15   VOUT V++ 80
R_R16   V- VOUT 80
.model PNP_LATERAL pnp(is=1e-016 bf=250
va=80
+ ik=0.138 rb=0.01 re=0.101 rc=180 kf=0 af=1)
.model PNP_input pnp(is=1e-016 bf=100
va=80
+ ik=0.138 rb=0.01 re=0.101 rc=180 kf=0 af=1)
.model DBREAK D(bv=43 rs=1)
.model DN D(KF=6.69e-9 AF=1)
.MODEL DX D(IS=1E-12 Rs=0.1)
.MODEL DY D(IS=1E-15 BV=50 Rs=1)
.ends ISL28108_208
```

FIGURE 68. SPICE NET LIST

Characterization vs Simulation Results



FIGURE 69. CHARACTERIZED INPUT NOISE VOLTAGE

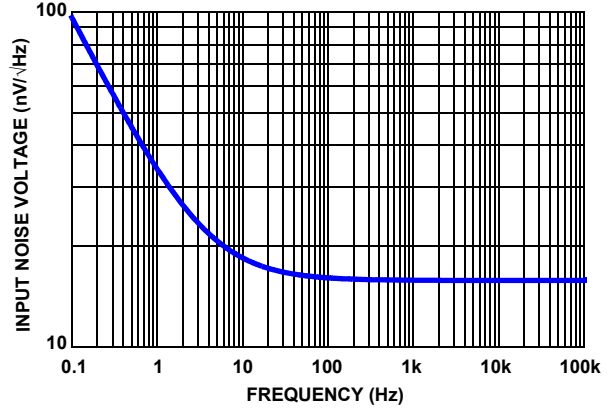

FIGURE 70. SIMULATED INPUT NOISE VOLTAGE



FIGURE 71. CHARACTERIZED OPEN-LOOP GAIN, PHASE vs FREQUENCY

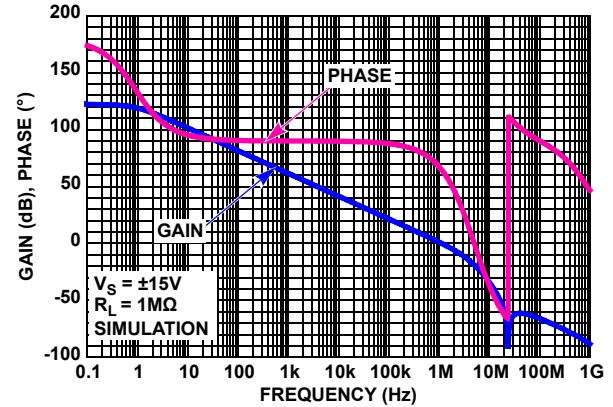

FIGURE 72. SIMULATED OPEN-LOOP GAIN, PHASE vs FREQUENCY



FIGURE 73. CHARACTERIZED CLOSED LOOP GAIN vs FREQUENCY

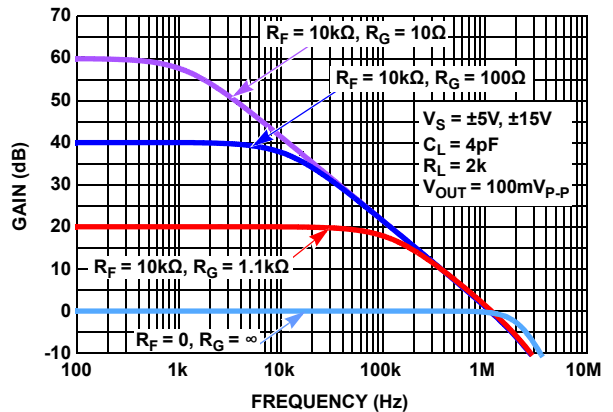

FIGURE 74. SIMULATED CLOSED LOOP GAIN vs FREQUENCY

Characterization vs Simulation Results (Continued)



FIGURE 75. CHARACTERIZED GAIN vs FREQUENCY vs R_L



FIGURE 76. SIMULATED GAIN vs FREQUENCY vs R_L



FIGURE 77. CHARACTERIZED CMRR vs FREQUENCY



FIGURE 78. SIMULATED CMRR vs FREQUENCY



FIGURE 79. CHARACTERIZED LARGE SIGNAL 10V STEP RESPONSE



FIGURE 80. SIMULATED LARGE SIGNAL 10V STEP RESPONSE

Characterization vs Simulation Results (Continued)



FIGURE 81. CHARACTERIZED SMALL SIGNAL TRANSIENT RESPONSE



FIGURE 82. SIMULATED SMALL SIGNAL TRANSIENT RESPONSE



FIGURE 83. SIMULATED OUTPUT VOLTAGE SWING

Revision History

The revision history provided is for informational purposes only and is believed to be accurate, but not warranted. Please go to web to make sure you have the latest Rev.

| DATE | REVISION | CHANGE |
|--------------|----------|---|
| Feb 6, 2020 | 5.01 | <p>Updated links throughout document.</p> <p>Updated related literature section.</p> <p>Updated ordering information table by adding tape and reel information, updating note 1, and removing ISL28108FUZ.</p> <p>Remove About Intersil section.</p> <p>Updated POD L8.3X3K to the latest revision, changes are as follows:</p> <p style="padding-left: 20px;">Tiebar Note 5 updated</p> <p style="padding-left: 20px;">From: Tiebar shown (if present) is a non-functional feature.</p> <p style="padding-left: 20px;">To: Tiebar shown (if present) is a non-functional feature and may be located on any of the 4 sides (or ends).</p> <p>Updated disclaimer.</p> |
| Mar 4, 2014 | 5.00 | <p>Updated absolute Maximum Ratings table on page 6, by adding ISL28108 MSOP value to ESD tolerance.</p> <p>Updated Spice model netlist on page 24.</p> |
| Jan 22, 2013 | 4.00 | <ul style="list-style-type: none"> • Added ISL28208 MSOP specifications. Moved Table of Contents to page 2. Removed "Coming Soon" from ISL28208FUZ entry in "Ordering Information" table on page 3. page 6, removed package indicators on Vos entries for ISL28208 and ISL28408; added ISL28208 MSOP entries for TCvos and deltaVos. page 7, removed package indicators on Ios entries for ISL28208 and ISL28408. page 8, removed package indicators on Vos and Ios entries for ISL28208 and ISL28408; added ISL28208 MSOP entries for TCvos, and added "ISL28108, ISL28208" to 4th and 5th rows of CMRR parameter. page 8, added ISL28208 MSOP entries for PSRR. page 10, added "+25°C" to "default" info at top of page. page 12, added "MSOP" to titles of Figures 15 and 16. |

The revision history provided is for informational purposes only and is believed to be accurate, but not warranted. Please go to web to make sure you have the latest Rev.

| DATE | REVISION | CHANGE |
|--------------|----------|---|
| Oct 19, 2011 | 3.00 | <ul style="list-style-type: none"> • On page 6, ±15V Electrical Specifications table, added the following parameters: <ul style="list-style-type: none"> - VOS ISL28108 SOIC, TDFN - TC沃斯 ISL28108 SOIC, TDFN - IOS ISL28108 SOIC, TDFN • On page 6 and 6, ±15V Electrical Specifications table, changed the following in Conditions column: <ul style="list-style-type: none"> - VOS: changed "ISL28208 SOIC, TDFN" to "ISL28208 SOIC, TDFN; ISL28408 SOIC" - TC沃斯: changed "ISL28208 TDFN" to "ISL28208 TDFN, ISL28408 SOIC" - IOS: changed "ISL28108 SOIC, TDFN" to "ISL28108 SOIC, TDFN; ISL28408 SOIC" • On page 8, ±5V Electrical Specifications table, added the following: <ul style="list-style-type: none"> - VOS ISL28108 SOIC, TDFN - TC沃斯 ISL28108 SOIC, TDFN - IOS ISL28108 SOIC, TDFN • On page 8, ±5V Electrical Specifications table, changed the following in Conditions column: <ul style="list-style-type: none"> - VOS: changed "ISL28208 SOIC, TDFN" to "ISL28208 SOIC, TDFN; ISL28408 SOIC" - TC沃斯: changed "ISL28208 TDFN" to "ISL28208 TDFN, ISL28408 SOIC" - IOS: changed "ISL28108 SOIC, TDFN" to "ISL28108 SOIC, TDFN; ISL28408 SOIC" • On page 10 through page 12, added the following to Typical Performance Curves: <ul style="list-style-type: none"> - Figures 3, 4: ISL28408 SOIC Input Offset Distribution Voltage, ±15V and ±5V - Figures 7, 8: ISL28108 SOIC ±15V VOS distribution, and ±5V VOS distribution - Figures 9, 10: ISL28108 TDFN ±15V VOS distribution, and ±5V VOS distribution - Figures 11, 12: ISL28408 SOIC TC沃斯 vs. number of Amplifiers ±15V and ±5V - Figures 17, 18: ISL28108 SOIC ±15V TC沃斯 distribution, and ±5V TC沃斯 distribution - Figures 19, 20: ISL28108 TDFN ±15V TC沃斯 distribution, and ±5V TC沃斯 distribution • On page 21, Applications: minor edits to re-align figures with curves • On page 22: changed heading from "Using Only One Amplifier to "Unused Channels" and edited for clarity. • On page 32: changed Package Outline Drawing L8.3x3A to L8.3x3K • On page 33: changed Package Outline Drawing M8.118 to M8.118B • On page 34: added Package Outline Drawing M14.15 • On page 1, Features: changed Low Input Offset Voltage from 230µV to (ISL28108).....150µV. Added Related Literature section with AN1658, "ISL28208SOICEVAL2Z Evaluation Board User Guide". • On page 3, Ordering Information: added ISL28208SOICEVAL2Z evaluation board. Removed "Coming Soon" from ISL28408FBZ. Corrected Package Dwg. # for TDFN package from L8.3x3A to L8.3x3K. Corrected Package Dwg. # for MSOP package from M8.118 to M8.118B. • On page 6, Absolute Maximum Ratings, changed "ESD Tolerance (ISL28208)" to "ESD Tolerance (ISL28208, ISL28408)". Added ESD information for ISL28108 as follows: <ul style="list-style-type: none"> ESD Tolerance (ISL28108) <ul style="list-style-type: none"> Human Body Model (Tested per JESD22-A114F).....5.5kV Machine Model (Tested per JESD22-A115-C).....300V Charged Device Model (Tested per JESD22-C110D).....2kV <hr/> <ul style="list-style-type: none"> • On page 6, Thermal Information, changed package temperatures from: <ul style="list-style-type: none"> 8 Ld SOIC Package (108, 208, Notes 4, 7), $\theta_{JA} = 120$, $\theta_{JC} = 55$ 8 Ld TDFN Package (108, 208, Notes 5, 6), $\theta_{JA} = 47$, $\theta_{JC} = 6$ 8 Ld MSOP Package (108, 208, Notes 4, 7), $\theta_{JA} = 150$, $\theta_{JC} = 45$ 14 Ld SOIC Package (408, Notes 4, 7), $\theta_{JA} = -$, $\theta_{JC} = -$ To: <ul style="list-style-type: none"> 8 Ld SOIC Package (208, Notes 4, 7), $\theta_{JA} = 120$, $\theta_{JC} = 55$ and 8 Ld SOIC Package (108, Notes 4, 7), $\theta_{JA} = 120$, $\theta_{JC} = 60$ 8 Ld TDFN Package (208, Notes 5, 6), $\theta_{JA} = 47$, $\theta_{JC} = 6$ and 8 Ld TDFN Package (108, Notes 5, 6), $\theta_{JA} = 45$, $\theta_{JC} = 3.5$ 8 Ld MSOP Package (208, Notes 4, 7), $\theta_{JA} = 150$, $\theta_{JC} = 50$ and 8 Ld MSOP Package (108, Notes 4, 7), $\theta_{JA} = 165$, $\theta_{JC} = 57$ 14 Ld SOIC Package (408, Notes 4, 7), $\theta_{JA} = 71$, $\theta_{JC} = 37$ |

The revision history provided is for informational purposes only and is believed to be accurate, but not warranted. Please go to web to make sure you have the latest Rev.

| DATE | REVISION | CHANGE |
|--------------|----------|--|
| Apr 20, 2011 | 2.00 | <ul style="list-style-type: none"> • Added discussion of ISL28408 throughout datasheet. • On page 3 in "Ordering Information": Added new part, "ISL28408FBZ". Corrected part marking for ISL28208FRTZ from 208Z to 208F. Added "ISL28408" to Note 3. Under "Pin Configurations," added ISL28408 (14 Ld SOIC) pin configuration diagram. • On page 5: in Pin Descriptions table, added column for ISL28408 14Ld SOIC. Corrected schematic for Circuit 2. • On page 6: under "Thermal Information" added "14 Ld SOIC Package (408, Notes 4, 7)" and added ISL28108 to 8 Ld TDFN and 8 Ld MSOP. Changed θ_{JA} and θ_{JC} for 8 Ld TDFN Package from 48 and 5.5 to 47 and 6. Added Note 6 regarding θ_{JC} "case temp" measurement, and applied it to 8 Ld TDFN Package. • On page 6: in Electrical Specifications table, changed TYP spec for TCI_B from 70 pA/° C to 0.07nA/° C. On page 8, changed TYP spec for TCI_B from -67 pA/° C to -0.067nA/° C. These are not spec changes since the values are the same. • On page 14, Figs. 31 and 32: changed y axis units label from (mV) to (V); changed x axis units label from (μA) to (mA). • On page 21, under "Output Drive Capability," para 2, changed "The output stage can swing at moderate levels of output current (Figures 21 and 22) and the output stage is internally current limited. Output current limit over-temperature..." to "The output stage is internally current limited. Output current limit over-temperature..." |
| Mar 11, 2011 | 1.00 | <ul style="list-style-type: none"> • On page 1, in the first paragraph - added the following after V-rail: "a rail-to-rail differential input voltage range for use as a comparator,...." • On page 1 in "Features: <ul style="list-style-type: none"> - Added bullet - "Rail-to-rail input differential voltage range for comparator applications" - Changed Low Noise Current from "100fA/sq.root Hz" to "80fA/sq.root Hz" • On page 3 in "Ordering Information" - Removed "coming soon" from ISL28208FRTZ part since it is releasing. • On page 6, changed "ESD Tolerance (ISL28208, ISL28408)" as follows: <ul style="list-style-type: none"> - Human Body Model changed from "3kV" to "6kV" - Machine Model changed from "300V" to "400V" - Added JEDEC Test information for all ESD ratings • On page 6 and page 8, added test conditions for SOIC TCVoS specs. Added TCVoS specs for TDFN. • On page 7 changed "Noise Current Density" Typical from "100" to "80" • On page 21, updated Applications Information Functional Description • On page 21 Updated Input Stage Performance Section • On page 21 Updated Output Drive Capability Section • On page 22 Added ISL28108 AND ISL28208 SPICE MODEL and License Agreement section • On page 23 Added SPICE NET LIST • On page 25 Added Characterization vs Simulation Results curves |
| Feb 16, 2011 | 0.00 | Initial Release |

Package Outline Drawings

For the most recent package outline drawing, see [M8.15E](#).

M8.15E
8 LEAD NARROW BODY SMALL OUTLINE PLASTIC PACKAGE
Rev 0, 08/09

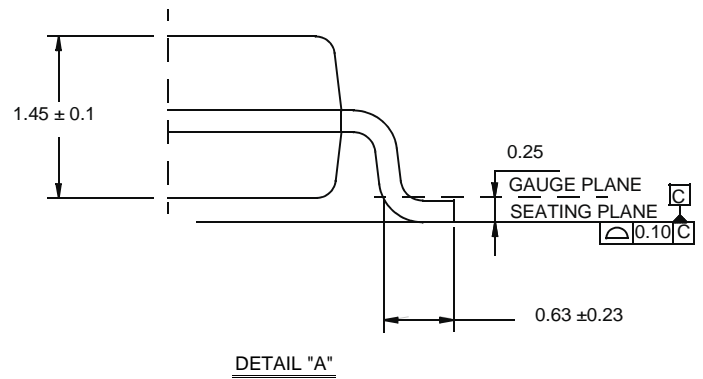
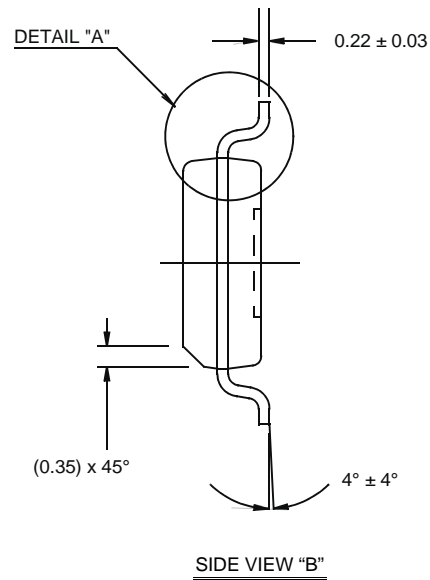
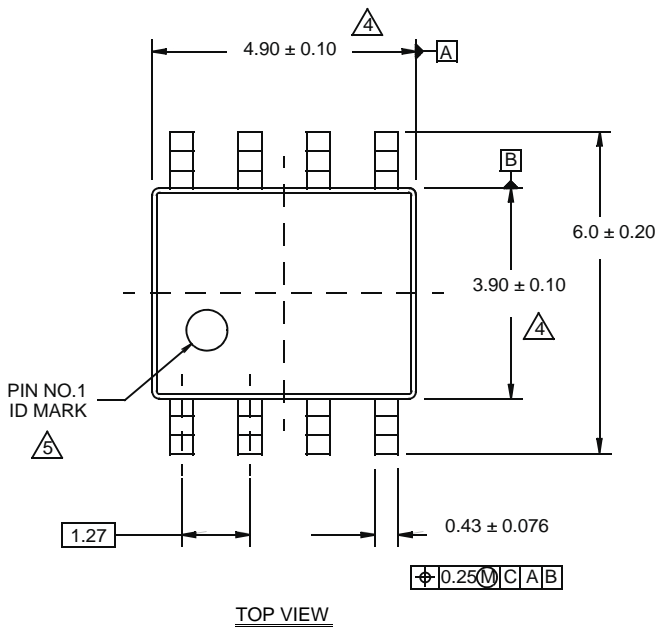

NOTES:

1. Dimensions are in millimeters.
Dimensions in () for Reference Only.
2. Dimensioning and tolerancing conform to AMSE Y14.5m-1994.
3. Unless otherwise specified, tolerance : Decimal ± 0.05
4. Dimension does not include interlead flash or protrusions.
Interlead flash or protrusions shall not exceed 0.25mm per side.
5. The pin #1 identifier may be either a mold or mark feature.
6. Reference to JEDEC MS-012.

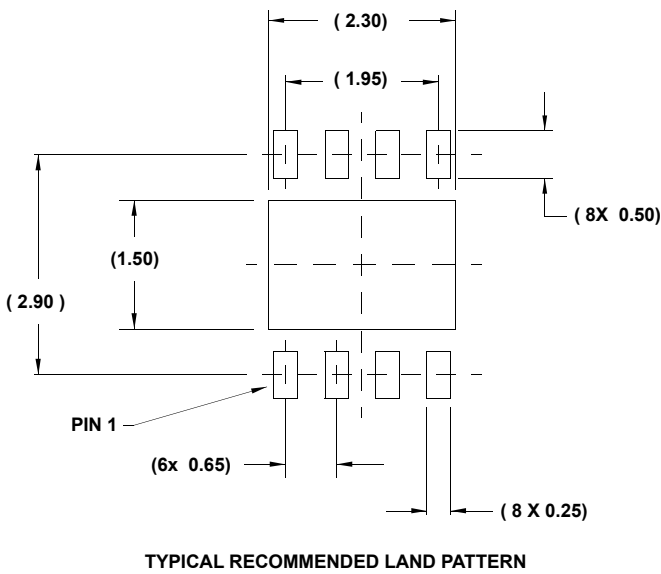
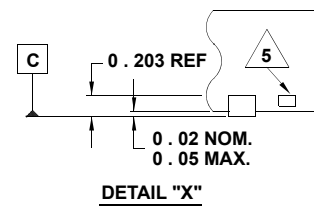
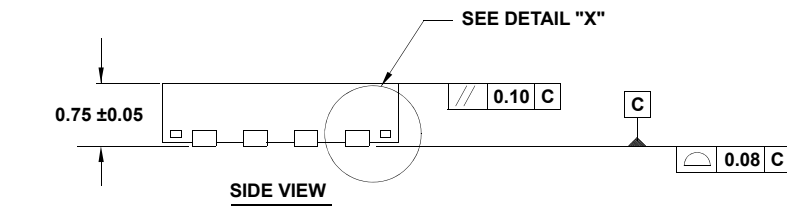

NOTES:

1. Dimensions are in millimeters.
Dimensions in () for Reference Only.
2. Dimensioning and tolerancing conform to ASME Y14.5m-1994.
3. Unless otherwise specified, tolerance : Decimal ± 0.05
4. Dimension applies to the metallized terminal and is measured between 0.15mm and 0.20mm from the terminal tip.
5. Tiebar shown (if present) is a non-functional feature and may be located on any of the 4 sides (or ends).
6. The configuration of the pin #1 identifier is optional, but must be located within the zone indicated. The pin #1 identifier may be either a mold or mark feature.
7. Compliant to JEDEC MO-229 WEEC-2 except for the foot length.

M8.118B
 8 LEAD MINI SMALL OUTLINE PLASTIC PACKAGE
 Rev 1, 3/12

For the most recent package outline drawing, see [M8.118B](#).



TOP VIEW

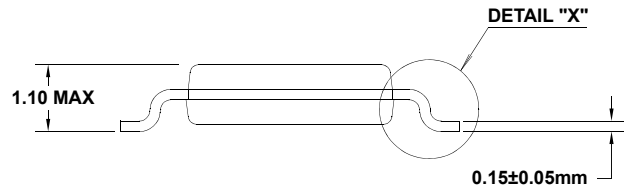

SIDE VIEW 2



SIDE VIEW 1

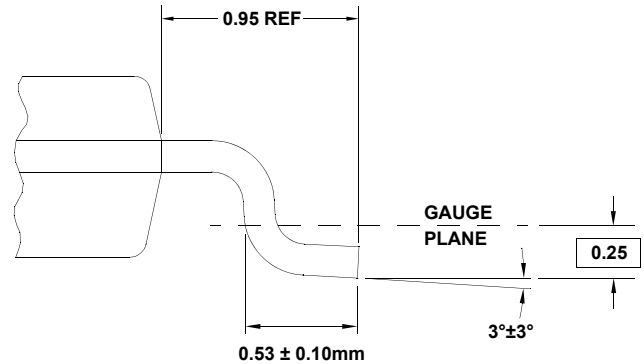

DETAIL "X"

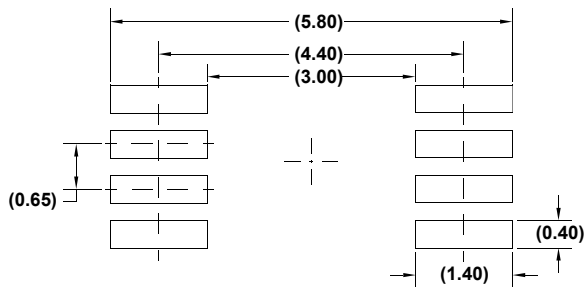

TYPICAL RECOMMENDED LAND PATTERN

NOTES:

1. Dimensions are in millimeters.
2. Dimensioning and tolerancing conform to JEDEC MO-187-AA and AMSEY14.5m-1994.
3. Plastic or metal protrusions of 0.15mm max per side are not included.
4. Plastic interlead protrusions of 0.15mm max per side are not included.
5. Dimensions are measured at Datum Plane "H".
6. Dimensions in () are for reference only.

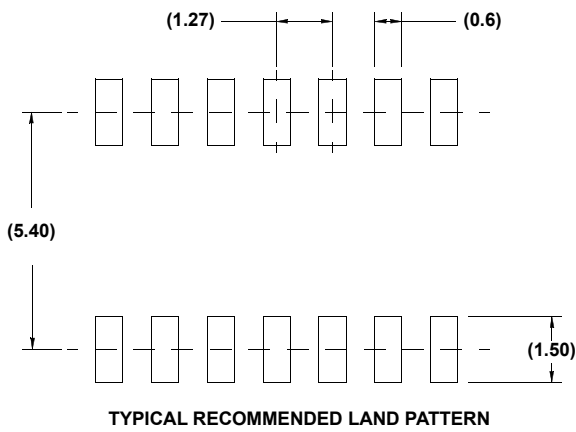
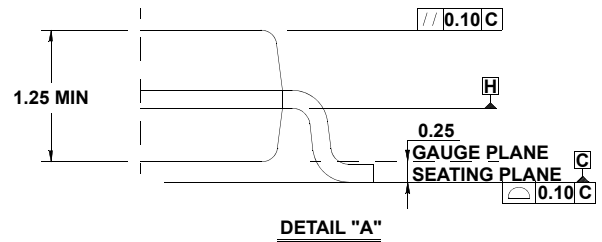
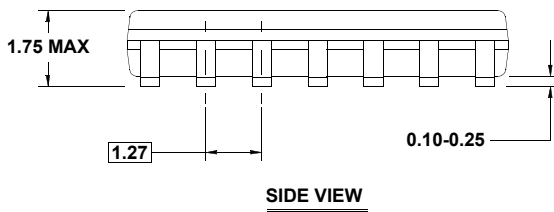
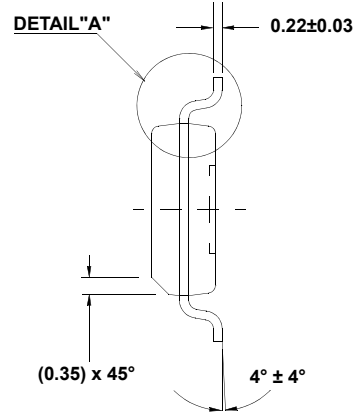

NOTES:

1. Dimensions are in millimeters.
 Dimensions in () for Reference Only.
2. Dimensioning and tolerancing conform to AMSEY14.5m-1994.
3. Datums A and B to be determined at Datum H.
4. Dimension does not include interlead flash or protrusions.
 Interlead flash or protrusions shall not exceed 0.25mm per side.
5. The pin #1 indentifier may be either a mold or mark feature.
6. Does not include dambar protrusion. Allowable dambar protrusion shall be 0.10mm total in excess of lead width at maximum condition.
7. Reference to JEDEC MS-012-AB.

Notice

1. Descriptions of circuits, software and other related information in this document are provided only to illustrate the operation of semiconductor products and application examples. You are fully responsible for the incorporation or any other use of the circuits, software, and information in the design of your product or system. Renesas Electronics disclaims any and all liability for any losses and damages incurred by you or third parties arising from the use of these circuits, software, or information.
2. Renesas Electronics hereby expressly disclaims any warranties against and liability for infringement or any other claims involving patents, copyrights, or other intellectual property rights of third parties, by or arising from the use of Renesas Electronics products or technical information described in this document, including but not limited to, the product data, drawings, charts, programs, algorithms, and application examples.
3. No license, express, implied or otherwise, is granted hereby under any patents, copyrights or other intellectual property rights of Renesas Electronics or others.
4. You shall not alter, modify, copy, or reverse engineer any Renesas Electronics product, whether in whole or in part. Renesas Electronics disclaims any and all liability for any losses or damages incurred by you or third parties arising from such alteration, modification, copying or reverse engineering.
5. Renesas Electronics products are classified according to the following two quality grades: "Standard" and "High Quality". The intended applications for each Renesas Electronics product depends on the product's quality grade, as indicated below.
 - "Standard": Computers; office equipment; communications equipment; test and measurement equipment; audio and visual equipment; home electronic appliances; machine tools; personal electronic equipment; industrial robots; etc.
 - "High Quality": Transportation equipment (automobiles, trains, ships, etc.); traffic control (traffic lights); large-scale communication equipment; key financial terminal systems; safety control equipment; etc.Unless expressly designated as a high reliability product or a product for harsh environments in a Renesas Electronics data sheet or other Renesas Electronics document, Renesas Electronics products are not intended or authorized for use in products or systems that may pose a direct threat to human life or bodily injury (artificial life support devices or systems; surgical implantations; etc.), or may cause serious property damage (space system; undersea repeaters; nuclear power control systems; aircraft control systems; key plant systems; military equipment; etc.). Renesas Electronics disclaims any and all liability for any damages or losses incurred by you or any third parties arising from the use of any Renesas Electronics product that is inconsistent with any Renesas Electronics data sheet, user's manual or other Renesas Electronics document.
6. When using Renesas Electronics products, refer to the latest product information (data sheets, user's manuals, application notes, "General Notes for Handling and Using Semiconductor Devices" in the reliability handbook, etc.), and ensure that usage conditions are within the ranges specified by Renesas Electronics with respect to maximum ratings, operating power supply voltage range, heat dissipation characteristics, installation, etc. Renesas Electronics disclaims any and all liability for any malfunctions, failure or accident arising out of the use of Renesas Electronics products outside of such specified ranges.
7. Although Renesas Electronics endeavors to improve the quality and reliability of Renesas Electronics products, semiconductor products have specific characteristics, such as the occurrence of failure at a certain rate and malfunctions under certain use conditions. Unless designated as a high reliability product or a product for harsh environments in a Renesas Electronics data sheet or other Renesas Electronics document, Renesas Electronics products are not subject to radiation resistance design. You are responsible for implementing safety measures to guard against the possibility of bodily injury, injury or damage caused by fire, and/or danger to the public in the event of a failure or malfunction of Renesas Electronics products, such as safety design for hardware and software, including but not limited to redundancy, fire control and malfunction prevention, appropriate treatment for aging degradation or any other appropriate measures. Because the evaluation of microcomputer software alone is very difficult and impractical, you are responsible for evaluating the safety of the final products or systems manufactured by you.
8. Please contact a Renesas Electronics sales office for details as to environmental matters such as the environmental compatibility of each Renesas Electronics product. You are responsible for carefully and sufficiently investigating applicable laws and regulations that regulate the inclusion or use of controlled substances, including without limitation, the EU RoHS Directive, and using Renesas Electronics products in compliance with all these applicable laws and regulations. Renesas Electronics disclaims any and all liability for damages or losses occurring as a result of your noncompliance with applicable laws and regulations.
9. Renesas Electronics products and technologies shall not be used for or incorporated into any products or systems whose manufacture, use, or sale is prohibited under any applicable domestic or foreign laws or regulations. You shall comply with any applicable export control laws and regulations promulgated and administered by the governments of any countries asserting jurisdiction over the parties or transactions.
10. It is the responsibility of the buyer or distributor of Renesas Electronics products, or any other party who distributes, disposes of, or otherwise sells or transfers the product to a third party, to notify such third party in advance of the contents and conditions set forth in this document.
11. This document shall not be reprinted, reproduced or duplicated in any form, in whole or in part, without prior written consent of Renesas Electronics.
12. Please contact a Renesas Electronics sales office if you have any questions regarding the information contained in this document or Renesas Electronics products.

(Note1) "Renesas Electronics" as used in this document means Renesas Electronics Corporation and also includes its directly or indirectly controlled subsidiaries.

(Note2) "Renesas Electronics product(s)" means any product developed or manufactured by or for Renesas Electronics.

(Rev.4.0-1 November 2017)

Corporate Headquarters

TOYOSU FORESIA, 3-2-24 Toyosu,
Koto-ku, Tokyo 135-0061, Japan
www.renesas.com

Contact Information

For further information on a product, technology, the most up-to-date version of a document, or your nearest sales office, please visit:
www.renesas.com/contact/

Trademarks

Renesas and the Renesas logo are trademarks of Renesas Electronics Corporation. All trademarks and registered trademarks are the property of their respective owners.



Компания «ЭлектроПласт» предлагает заключение долгосрочных отношений при поставках импортных электронных компонентов на взаимовыгодных условиях!

Наши преимущества:

- Оперативные поставки широкого спектра электронных компонентов отечественного и импортного производства напрямую от производителей и с крупнейших мировых складов;
- Поставка более 17-ти миллионов наименований электронных компонентов;
- Поставка сложных, дефицитных, либо снятых с производства позиций;
- Оперативные сроки поставки под заказ (от 5 рабочих дней);
- Экспресс доставка в любую точку России;
- Техническая поддержка проекта, помощь в подборе аналогов, поставка прототипов;
- Система менеджмента качества сертифицирована по Международному стандарту ISO 9001;
- Лицензия ФСБ на осуществление работ с использованием сведений, составляющих государственную тайну;
- Поставка специализированных компонентов (Xilinx, Altera, Analog Devices, Intersil, Interpoint, Microsemi, Aeroflex, Peregrine, Syfer, Eurofarad, Texas Instrument, Miteq, Cobham, E2V, MA-COM, Hittite, Mini-Circuits, General Dynamics и др.);

Помимо этого, одним из направлений компании «ЭлектроПласт» является направление «Источники питания». Мы предлагаем Вам помощь Конструкторского отдела:

- Подбор оптимального решения, техническое обоснование при выборе компонента;
- Подбор аналогов;
- Консультации по применению компонента;
- Поставка образцов и прототипов;
- Техническая поддержка проекта;
- Защита от снятия компонента с производства.



Как с нами связаться

Телефон: 8 (812) 309 58 32 (многоканальный)

Факс: 8 (812) 320-02-42

Электронная почта: org@eplast1.ru

Адрес: 198099, г. Санкт-Петербург, ул. Калинина, дом 2, корпус 4, литера А.