

## Phototriac, Zero Crossing, 1.5 kV/ $\mu$ s dV/dt, 600 V

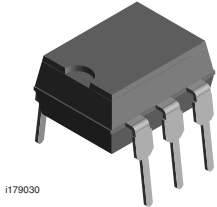

1179030

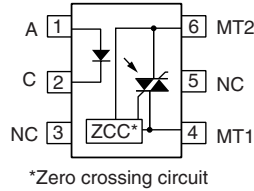

### DESCRIPTION

The VO3062/3063 triac driver family consists of a GaAs infrared LED optically coupled to a monolithic photosensitive zero crossing triac detector chip. The 600 V blocking voltage permits control of off-line voltages up to 240 VAC, with a safety factor of more than two, and is sufficient for as much as 380 V.

### FEATURES

- 1500 V/ $\mu$ s dV/dt minimum
- 600 V blocking voltage
- 100 mA on-state current
- Zero crossing detector
- Low input trigger current
- 6 pin DIP package
- Lead (Pb)-free component
- Component in accordance to RoHS 2002/95/EC and WEEE 2002/96/EC



**RoHS**  
COMPLIANT

### APPLICATIONS

- Household appliances
- Triac drive/AC motor drives
- Solenoid/valve controls
- Office automation equipment/machine
- Temperature (HVAC)/lighting controls
- Switching power supply

### AGENCY APPROVALS

- UL1577, file no. E52744 system code U/J
- CUL - file no. E52744, equivalent to CSA bulletin 5A
- DIN EN 60747-5-5 (VDE 0884) available with option 1
- BSI IEC 60950

ORDER INFORMATION	
PART	REMARKS
VO3063	DIP-6, ZC, 600 V, $I_{ft} = 5$ mA
VO3062	DIP-6, ZC, 600 V, $I_{ft} = 10$ mA
VO3063-X006	DIP-6 400 mil, ZC, 600 V, $I_{ft} = 5$ mA
VO3062-X006	DIP-6 400 mil, ZC, 600 V, $I_{ft} = 10$ mA
VO3063-X007T	SMD-6, ZC, 600 V, $I_{ft} = 5$ mA
VO3062-X007T	SMD-6, ZC, 600 V, $I_{ft} = 10$ mA

#### Note

For additional information on the available options refer to option information.

ABSOLUTE MAXIMUM RATINGS					
PARAMETER	TEST CONDITION	PART	SYMBOL	VALUE	UNIT
<b>INPUT</b>					
Reverse voltage			$V_R$	6	V
Forward current - continuous			$I_F$	60	mA
Power dissipation			$P_{diss}$	100	mW
<b>OUTPUT</b>					
Off state output terminal voltage		VO3062/3063	$V_{DRM}$	600	V
Peak repetitive surge current	PW = 100 ms, 120 pps		$I_{TSM}$	1	A
Power dissipation			$P_{diss}$	200	mW
On-state RMS current			$I_{T(RMS)}$	100	mA

ABSOLUTE MAXIMUM RATINGS					
PARAMETER	TEST CONDITION	PART	SYMBOL	VALUE	UNIT
<b>COUPLER</b>					
Isolation test voltage	t = 1 s		V <sub>ISO</sub>	5300	V <sub>RMS</sub>
Total power dissipation			P <sub>tot</sub>	300	mW
Operating temperature range			T <sub>amb</sub>	- 40 to + 100	°C
Storage temperature range			T <sub>stg</sub>	- 55 to + 150	°C
Soldering temperature	maximum ≤ 10 s		T <sub>sld</sub>	260	°C

**Note**

T<sub>amb</sub> = 25 °C, unless otherwise specified.

Stresses in excess of the absolute maximum ratings can cause permanent damage to the device. Functional operation of the device is not implied at these or any other conditions in excess of those given in the operational sections of this document. Exposure to absolute maximum ratings for extended periods of the time can adversely affect reliability.



Fig. 1 - On-State Current (RMS) vs. Temperature

**Note**

The allowable load current was calculated out under a given operating conditions and only for reference:

LED power: Q<sub>E</sub> = 0.015 W, R<sub>BA</sub> (2-layer) = 72 °C/W

THERMAL CHARACTERISTICS				
PARAMETER	TEST CONDITION	SYMBOL	VALUE	UNIT
Maximum LED junction temperature		T <sub>Jmax</sub>	125	°C
Maximum output die junction temperature		T <sub>Jmax</sub>	125	°C
Thermal resistance, junction emitter to board		θ <sub>JEB</sub>	150	°C/W
Thermal resistance, junction emitter to case		θ <sub>JEC</sub>	139	°C/W
Thermal resistance, junction detector to board		θ <sub>JDB</sub>	78	°C/W
Thermal resistance, junction detector to case		θ <sub>JDC</sub>	103	°C/W
Thermal resistance, junction emitter to junction detector		θ <sub>JED</sub>	496	°C/W
Thermal resistance, case to ambient		θ <sub>CA</sub>	3563	°C/W

**Note**

The thermal model is represented in the thermal network below. Each resistance value given in this model can be used to calculate the temperatures at each node for a given operating condition. The thermal resistance from board to ambient will be dependent on the type of PCB, layout and thickness of copper traces. For a detailed explanation of the thermal model, please reference Vishay's Thermal Characteristics of Optocouplers Application note.



ELECTRICAL CHARACTERISTICS							
PARAMETER	TEST CONDITION	PART	SYMBOL	MIN.	TYP.	MAX.	UNIT
<b>INPUT</b>							
Reverse current	$V_R = 6\text{ V}$		$I_R$			10	$\mu\text{A}$
Forward voltage	$I_F = 30\text{ mA}$		$V_F$		1.2	1.5	V
<b>OUTPUT</b>							
Leakage with LED off, either direction	$V_{DRM} = 600\text{ V}$		$I_{DRM}$		10	500	nA
Critical rate of rise off-state voltage	$V_D = 400\text{ V}$		dV/dt	1500	2000		V/ $\mu$ s
<b>COUPLER</b>							
LED trigger current, current required to latch output		VO3063	$I_{FT}$			5	mA
		VO3062	$I_{FT}$			10	mA
Peak on-state voltage, either direction	$I_{TM} = 100\text{ mA Peak}$ $I_F = \text{Rated } I_{FT}$		$V_{TM}$		1.7	3	V
Holding current, either direction			$I_H$		200		$\mu\text{A}$
Inhibit voltage (MT1-MT2 voltage above which device will not trigger)			$V_{INH}$		12	22	V
Leakage in inhibited state	$I_F = 10\text{ mA maximum}$ , at rated $V_{DRM}$ , off state		$V_{DRM2}$		250	1000	$\mu\text{A}$

**Note**

$T_{amb} = 25\text{ }^\circ\text{C}$ , unless otherwise specified.

Minimum and maximum values were tested requirements. Typical values are characteristics of the device and are the result of engineering evaluations. Typical values are for information only and are not part of the testing requirements.

SAFETY AND INSULATION RATINGS							
PARAMETER	TEST CONDITION	SYMBOL	MIN.	TYP.	MAX.	UNIT	
Climatic classification	IEC 68 part 1			40/85/21			
Pollution degree	DIN VDE 0109			2			
Comparative tracking index per DIN IEC 112/VDE 0303 part 1, group IIIa per DIN VDE 6110 175 399		CTI	175				
Highest allowable overvoltage	Transient overvoltage	$V_{IOTM}$	8000			$V_{peak}$	
Maximum working insulation voltage	Recurring peak voltage	$V_{IORM}$	890			$V_{peak}$	
Insulation resistance at 25 $^\circ\text{C}$	$V_{IO} = 500\text{ V}$	$R_{IS}$			$\geq 10^{12}$	$\Omega$	
Insulation resistance at $T_S$	$V_{IO} = 500\text{ V}$	$R_{IS}$			$\geq 10^9$	$\Omega$	
Insulation resistance at 100 $^\circ\text{C}$	$V_{IO} = 500\text{ V}$	$R_{IS}$			$\geq 10^{11}$	$\Omega$	

SAFETY AND INSULATION RATINGS						
PARAMETER	TEST CONDITION	SYMBOL	MIN.	TYP.	MAX.	UNIT
Partial discharge test voltage	Method a, $V_{pd} = V_{IORM} \times 1.875$	$V_{pd}$			1325	$V_{peak}$
Safety limiting values - maximum values allowed in the event of a failure	Safety power rating	$P_{SO}$			400	mW
	Safety current rating	$I_{SI}$			150	mA
	Safety temperature rating	$T_{SI}$			165	°C
Minimum external air gap (clearance)	Measured from input terminals to output terminals, shortest distance through air		≥ 7			mm
Minimum external tracking (creepage)	Measured from input terminals to output terminals, shortest distance path along body		≥ 7			mm

**Note**

As per IEC 60747-5-2, 7.4.3.8.1, this optocoupler is suitable for “safe electrical insulation” only within the safety ratings. Compliance with the safety ratings shall be ensured by means of protective circuits.

**TYPICAL CHARACTERISTICS**

$T_{amb} = 25\text{ °C}$ , unless otherwise specified



Fig. 2 - Forward Voltage vs. Forward Current

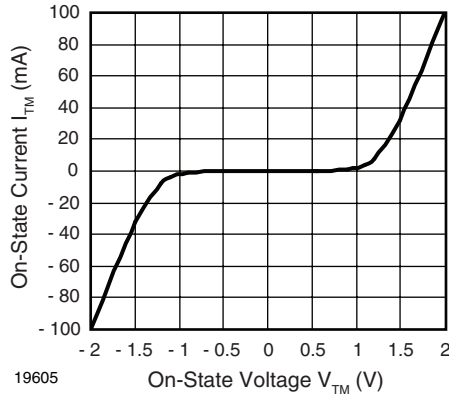

Fig. 4 - On-State Current vs.  $V_{TM}$

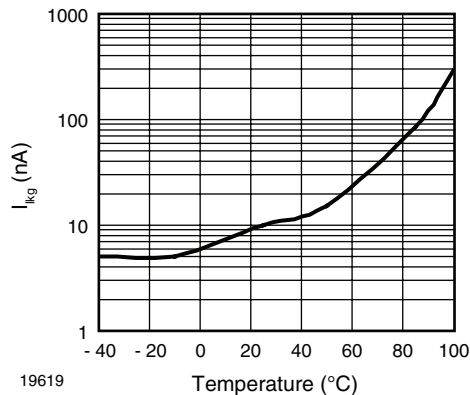

Fig. 3 - Off-State Leakage Current vs. Temperature



Fig. 5 - Normalized Trigger Current vs. Temperature



Fig. 6 - Turn-on Time vs. LED Current

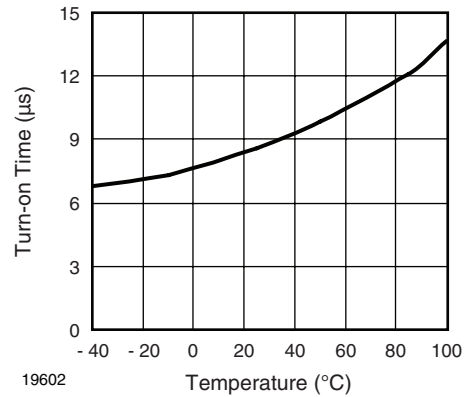

Fig. 8 - Turn-on Time vs. Temperature

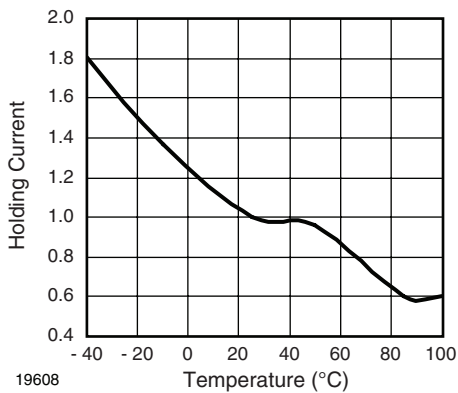

Fig. 7 - Normalized Holding Current vs. Temperature

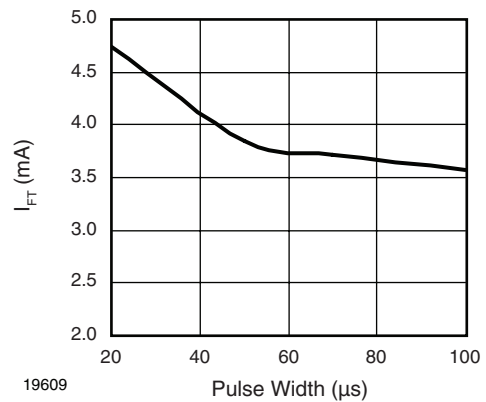
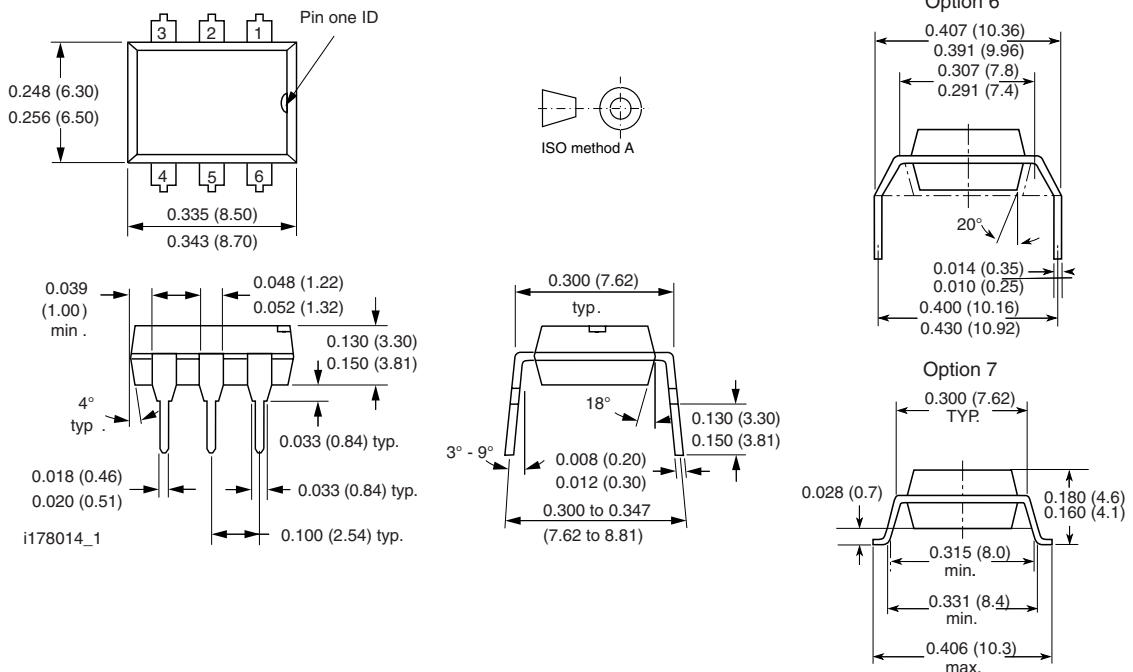

Fig. 9 - Trigger Current vs. Pulse Width

**PACKAGE DIMENSIONS** in inches (millimeters)



## **OZONE DEPLETING SUBSTANCES POLICY STATEMENT**

It is the policy of Vishay Semiconductor GmbH to

1. Meet all present and future national and international statutory requirements.
2. Regularly and continuously improve the performance of our products, processes, distribution and operating systems with respect to their impact on the health and safety of our employees and the public, as well as their impact on the environment.

It is particular concern to control or eliminate releases of those substances into the atmosphere which are known as ozone depleting substances (ODSs).

The Montreal Protocol (1987) and its London Amendments (1990) intend to severely restrict the use of ODSs and forbid their use within the next ten years. Various national and international initiatives are pressing for an earlier ban on these substances.

Vishay Semiconductor GmbH has been able to use its policy of continuous improvements to eliminate the use of ODSs listed in the following documents.

1. Annex A, B and list of transitional substances of the Montreal Protocol and the London Amendments respectively.
2. Class I and II ozone depleting substances in the Clean Air Act Amendments of 1990 by the Environmental Protection Agency (EPA) in the USA
3. Council Decision 88/540/EEC and 91/690/EEC Annex A, B and C (transitional substances) respectively.

Vishay Semiconductor GmbH can certify that our semiconductors are not manufactured with ozone depleting substances and do not contain such substances.

We reserve the right to make changes to improve technical design  
and may do so without further notice.

Parameters can vary in different applications. All operating parameters must be validated for each customer application by the customer. Should the buyer use Vishay Semiconductors products for any unintended or unauthorized application, the buyer shall indemnify Vishay Semiconductors against all claims, costs, damages, and expenses, arising out of, directly or indirectly, any claim of personal damage, injury or death associated with such unintended or unauthorized use.

Vishay Semiconductor GmbH, P.O.B. 3535, D-74025 Heilbronn, Germany



## Disclaimer

All product specifications and data are subject to change without notice.

Vishay Intertechnology, Inc., its affiliates, agents, and employees, and all persons acting on its or their behalf (collectively, "Vishay"), disclaim any and all liability for any errors, inaccuracies or incompleteness contained herein or in any other disclosure relating to any product.

Vishay disclaims any and all liability arising out of the use or application of any product described herein or of any information provided herein to the maximum extent permitted by law. The product specifications do not expand or otherwise modify Vishay's terms and conditions of purchase, including but not limited to the warranty expressed therein, which apply to these products.

No license, express or implied, by estoppel or otherwise, to any intellectual property rights is granted by this document or by any conduct of Vishay.

The products shown herein are not designed for use in medical, life-saving, or life-sustaining applications unless otherwise expressly indicated. Customers using or selling Vishay products not expressly indicated for use in such applications do so entirely at their own risk and agree to fully indemnify Vishay for any damages arising or resulting from such use or sale. Please contact authorized Vishay personnel to obtain written terms and conditions regarding products designed for such applications.

Product names and markings noted herein may be trademarks of their respective owners.



Компания «ЭлектроПласт» предлагает заключение долгосрочных отношений при поставках импортных электронных компонентов на взаимовыгодных условиях!

Наши преимущества:

- Оперативные поставки широкого спектра электронных компонентов отечественного и импортного производства напрямую от производителей и с крупнейших мировых складов;
- Поставка более 17-ти миллионов наименований электронных компонентов;
- Поставка сложных, дефицитных, либо снятых с производства позиций;
- Оперативные сроки поставки под заказ (от 5 рабочих дней);
- Экспресс доставка в любую точку России;
- Техническая поддержка проекта, помощь в подборе аналогов, поставка прототипов;
- Система менеджмента качества сертифицирована по Международному стандарту ISO 9001;
- Лицензия ФСБ на осуществление работ с использованием сведений, составляющих государственную тайну;
- Поставка специализированных компонентов (Xilinx, Altera, Analog Devices, Intersil, Interpoint, Microsemi, Aeroflex, Peregrine, Syfer, Eurofarad, Texas Instrument, Miteq, Cobham, E2V, MA-COM, Hittite, Mini-Circuits, General Dynamics и др.);

Помимо этого, одним из направлений компании «ЭлектроПласт» является направление «Источники питания». Мы предлагаем Вам помощь Конструкторского отдела:

- Подбор оптимального решения, техническое обоснование при выборе компонента;
- Подбор аналогов;
- Консультации по применению компонента;
- Поставка образцов и прототипов;
- Техническая поддержка проекта;
- Защита от снятия компонента с производства.



#### Как с нами связаться

**Телефон:** 8 (812) 309 58 32 (многоканальный)

**Факс:** 8 (812) 320-02-42

**Электронная почта:** [org@eplast1.ru](mailto:org@eplast1.ru)

**Адрес:** 198099, г. Санкт-Петербург, ул. Калинина, дом 2, корпус 4, литера А.