

## Description

Single, two and three pole magnetic and hydraulic-magnetic circuit breakers with trip-free mechanism and toggle actuation. A choice of fast magnetic only or hydraulically delayed switching characteristics (S-type MO or HM CBE to EN 60934) ensures suitability for a wide range of applications. Featuring a combi-foot design for symmetric rail mounting. Low temperature sensitivity at rated load. Approved to CBE standard EN 60934 (IEC 60934).

## Typical applications

Power supplies, control equipment, communication systems, EDP systems.

## Standard current ratings and typical internal resistance values

Current rating (A)	Internal resistance values (Ω) per pole			
	F1	F2	K1, M1, T1	K2, M2, T2
0,02	1 493	953	2 669	2 457
0,05	276	152	452	376
0,1	58	37	100	94
0,25	8,2	6,0	15,5	14,7
0,5	2,3	1,47	3,9	3,2
0,75	0,98	0,63	1,65	1,56
1	0,58	0,35	0,95	0,90
2	0,145	0,096	0,26	0,20
2,5	0,096	0,061	0,15	0,15
3	0,065	0,048	0,10	0,10
5	0,025	< 0,02	0,042	0,040
6	< 0,02	< 0,02	0,029	0,028
8	< 0,02	< 0,02	< 0,02	< 0,02
10	< 0,02	< 0,02	< 0,02	< 0,02
12	< 0,02	< 0,02	< 0,02	< 0,02
15	< 0,02	< 0,02	< 0,02	< 0,02
16	< 0,02	< 0,02	< 0,02	< 0,02
20	< 0,02	< 0,02	< 0,02	< 0,02
25	< 0,02	< 0,02	< 0,02	< 0,02
30	< 0,02	< 0,02	< 0,02	< 0,02
40	< 0,01	-	< 0,01	-
50	< 0,01	-	< 0,01	-



single pole

8340-T...

three pole

## Technical data

For further details please see: [http://www.e-t-a.de/ti\\_e](http://www.e-t-a.de/ti_e)

Voltage rating	3 AC 415V; AC 240V (50/60Hz); DC 80V (higher DC voltages to special order)		
Current rating range	0.02...50 A DC 0.02...30 A AC		
Auxiliary circuit	1 A, AC 240 V/DC 65 V; 0.5 A DC 80 V		
Typical life	3 AC 415 V AC 240 V: 0.02...30 A 6,000 operations at 1 x I <sub>N</sub> , inductive 10,000 operations at 1 x I <sub>N</sub> , resistive WDC 80 V: 0.02...25 A 6,000 operations at 1 x I <sub>N</sub> , inductive 0.02...30 A 10,000 operations at 1 x I <sub>N</sub> , resistive 40 + 50 A 6,000 operations at 1 x I <sub>N</sub> , resistive		
Ambient temperature	-40...+85 °C (-40...+185 °F)		
Insulation co-ordination (IEC 60664 and 60664A)	rated impulse withstand voltage 2.5 kV reinforced insulation in operating area	pollution degree 2	
Dielectric strength (IEC 60664 and 60664A)	operating area Line to Load pole to pole (2- and 3-pole) main to auxiliary circuit	test voltage AC 3,000 V test voltage AC 1,500 V test voltage AC 1,500 V test voltage AC 1,500 V	
Insulation resistance	> 100 MΩ (DC 500 V)		
Interrupting capacity	6 x IN at AC; IEC 60934 - test sequence E 4 x IN at DC		
Interrupting capacity (UL 1077)	I <sub>N</sub>	0.02...20 A	25...30 A
	AC:	1-pole AC 250 V/3,500A	AC 250 V/3,500A
		2-pole AC 250 V/3,500A	AC 250 V/5,000A
		3-pole 3AC 250V/3,500A	3AC250V/5,000A
	DC:	1-pole 0.02...50 A	DC 80 V/3,500 A
		2-pole 0.02...30 A	DC 80 V/3500 A
Degree of protection (IEC 60529/DIN 40050)	operating area IP40 terminal area IP20		
Vibration	with toggle down: 10 g at 0.9 I <sub>N</sub> directions 1, 2, 3, 4, 5: 10 g at 1 x I <sub>N</sub> with curves F1, F2: 10 g at 0.8 x I <sub>N</sub> in all planes. (57-2000 Hz) ± 0.76 mm (10-57 Hz) to IEC 60068-2-6, test Fc 10 frequency cycles/axis		
Shock	directions 1, 2, 3, 4, 5: 100 g (11 ms) at 1 x I <sub>N</sub> direction 6: 100 g (11 ms) at 0.8 x I <sub>N</sub> with curves F1, F2: 100 g (11 ms) at 0.8 x I <sub>N</sub> to IEC 60068-2-27, test Ea		
Corrosion	96 hours at 5 % salt mist, to IEC 60068-2-11, test Ka		
Humidity	240 hours at 95 % RH, to IEC 60068-2-78, test Cab		
Mass	approx. 98 g per pole		

**Ordering information**

<b>Type No.</b>	
8340	circuit breaker with toggle actuator
<b>Mounting</b>	
T	rail mounting
<b>Configuration</b>	
1	snap-on installation
<b>Number of poles</b>	
1	single pole protected
2	two pole protected
3	three pole protected
	} magnetic, hydraulic-magnetic
<b>Panel hardware</b>	
0	without panel hardware
<b>Terminal design (main contact)</b>	
K1	recessed screw/pressure plates M4
<b>Characteristic curve *)</b>	
<b>Characteristic curve, instantaneous:</b>	
F1	DC
F2	AC 50/60 Hz
<b>Short delay:</b>	
K1	DC
K2	AC 50/60 Hz
<b>Medium delay:</b>	
M1	DC
M2	AC 50/60 Hz
<b>Long delay:</b>	
T1	DC
T2	AC 50/60 Hz
<b>Actuator colour / design</b>	
A	black, long toggle
K	black, short toggle
<b>Marking on actuator</b>	
0	without marking
L	I-O; ON-OFF
M	I-O; ON-OFF (I <sub>N</sub> , U <sub>N</sub> , trip curve, schematic diagram on housing top)
N	I-O; ON-OFF (I <sub>N</sub> , on housing top)
<b>Auxiliary contacts</b>	
H0	without auxiliary contacts
H1	with auxiliary contact
H2	with auxiliary contact on one pole only (multipole)
<b>Auxiliary contact function</b> (see internal connection diagrams)	
2	1 N/O contact
3	1 N/C contact
<b>Auxiliary contact terminal design</b>	
6	screw/pressure plate M3
<b>Current ratings</b>	
0.02...50 A	
8340 - T 1 1 0 - K1 M1 - A L H1 2 6 - 10 A ordering example	

**Approvals**

Authority	Standard	Rated voltage	Current ratings
VDE	IEC / EN 60934	AC 240/415 V AC 240 V DC 80 V	0.02 A...30 A 0.02 A...30 A 0.02 A...50 A
UL	UL 1077	AC 250 V DC 80 V DC 80 V	0.02 A...30 A 0.02 A...50 A 100 A (2 poles in parallel)
UL	UL 489A	DC 80 V	0.05 A...30 A (1 + 2 pole)
CSA	C22.2 No 235	AC 250 V DC 80 V	0.02 A...30 A 0.02 A...30 A
CQC	GB 17701	AC 240/415 V AC 240 V DC 80 V	0.02 A...30 A 0.02 A...30 A 0.02 A...50 A
QPL Sweden Defence Material Admin.	MIL-C-55629	AC 240 V DC 50 V AC 240 V AC 240 / 415 V	1 A...30 A (8340-F410) 1 A...30 A (8340-410) 1 A...30 A (8340-F420) 1 A...30 A (8340-F430)

This is a metric design and millimeter dimensions take precedence ( $\frac{mm}{inch}$ )

\*) **Other characteristic curves upon request** (e.g. pulse delayed, for high inrush currents or capacitive loads)

Please be informed that we have minimum ordering quantities to be observed.

**Dimensions**

**long toggle**

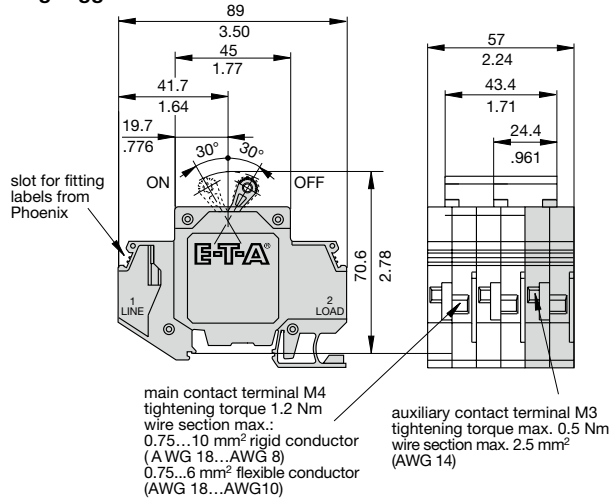

**short toggle**

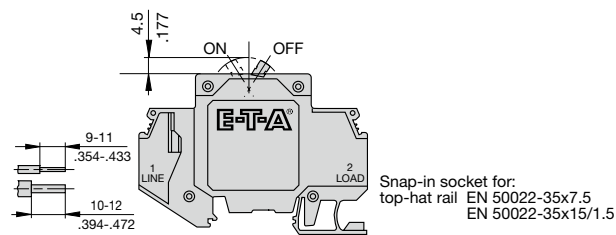

**Installation drawing**



**Internal connection diagrams**

**1-pole protected magnetically**

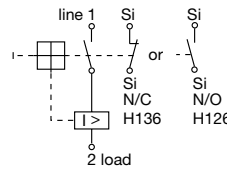

**multipole**

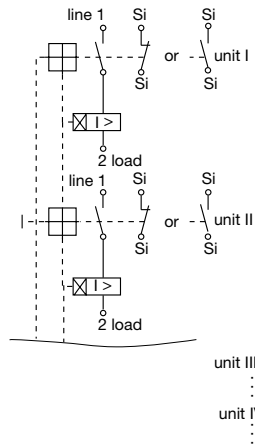

**1-pole protected hydraulic-magnetically**

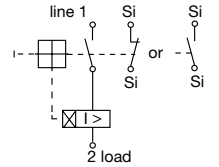

Optional N/C or N/O auxiliary contact (Si)

**Shock directions**



Typical time/current characteristics at 23 °C / +73.4 °F

**Curve F1 (instantaneous) for DC**



**Curve F2 (instantaneous) for AC**



**Curve K1 (short delay) for DC**



**Curve K2 (short delay) for AC 50/60 Hz**



**Curve M1 (medium delay) for DC**



**Curve M2 (medium delay) for AC 50/60 Hz**



**Curve T1 (long delay) for DC**



**Curve T2 (long delay) for AC 50/60 Hz**



**N.B.** All curves will only be maintained if the escutcheon is mounted on a vertical surface. Ambient temperature or mounting side-by-side does not influence the trip curve, derating is not required. The breakers may trip in the event of current peaks < 0.003 sec. For these applications we offer a mechanical pulse delay – please enquire.  
**Other characteristic curves upon request (e.g. pulse delayed, for high inrush currents or capacitive loads).**

**Accessories**

**Connector bus links -K10**

**X210 589 01**/2.5 mm<sup>2</sup>, (AWG 14) (black) up to 20 A max. load  
**X210 589 02**/1.5 mm<sup>2</sup>, (AWG 16) (brown) up to 13 A max. load



**Busbar 1-pole**  
**Y 308 495 01**

The one metre long busbars can be cut to suitable lengths. Plug-on caps can be fitted on the ends to provide brush contact protection.

I<sub>max</sub> - busbar 100 A (40 °C)



**Plug-on cap, 1-pole**  
**Y 307 851 01**



**Busbar 2-pole**  
**Y 308 496 01**

I<sub>max</sub> - busbar 100 A (40 °C)

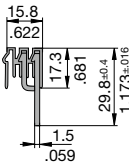
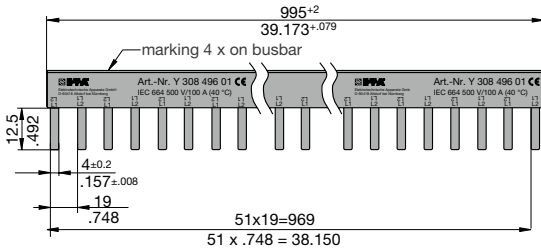

**Plug-on cap, busbar 2/3-pole**  
**Y 308 506 01**



**Busbar 3-pole**  
**Y 308 497 01**

I<sub>max</sub> - busbar 100 A (40 °C)

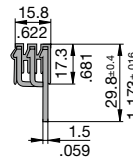

**Plug-on cap, busbar 2/3-pole**  
**Y 308 506 01**

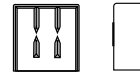

**Supply terminal I<sub>max</sub> 63 A**

**Y 308 504 01**

Max. tightening torque of terminal screw 2 Nm  
 Max. cable cross section: 25 mm<sup>2</sup> / single strand  
 16 mm<sup>2</sup> / multistrand with wire end ferrule



**Caution:**

When using multipole busbars please leave at least one pole's width between two adjacent line entry terminals.

This is a metric design and millimeter dimensions take precedence (mm / inch)

All dimensions without tolerances are for reference only. In the interest of improved design, performance and cost effectiveness the right to make changes in these specifications without notice is reserved. Product markings may not be exactly as the ordering codes. Errors and omissions excepted.







Компания «ЭлектроПласт» предлагает заключение долгосрочных отношений при поставках импортных электронных компонентов на взаимовыгодных условиях!

Наши преимущества:

- Оперативные поставки широкого спектра электронных компонентов отечественного и импортного производства напрямую от производителей и с крупнейших мировых складов;
- Поставка более 17-ти миллионов наименований электронных компонентов;
- Поставка сложных, дефицитных, либо снятых с производства позиций;
- Оперативные сроки поставки под заказ (от 5 рабочих дней);
- Экспресс доставка в любую точку России;
- Техническая поддержка проекта, помощь в подборе аналогов, поставка прототипов;
- Система менеджмента качества сертифицирована по Международному стандарту ISO 9001;
- Лицензия ФСБ на осуществление работ с использованием сведений, составляющих государственную тайну;
- Поставка специализированных компонентов (Xilinx, Altera, Analog Devices, Intersil, Interpoint, Microsemi, Aeroflex, Peregrine, Syfer, Eurofarad, Texas Instrument, Miteq, Cobham, E2V, MA-COM, Hittite, Mini-Circuits, General Dynamics и др.);

Помимо этого, одним из направлений компании «ЭлектроПласт» является направление «Источники питания». Мы предлагаем Вам помощь Конструкторского отдела:

- Подбор оптимального решения, техническое обоснование при выборе компонента;
- Подбор аналогов;
- Консультации по применению компонента;
- Поставка образцов и прототипов;
- Техническая поддержка проекта;
- Защита от снятия компонента с производства.



#### Как с нами связаться

**Телефон:** 8 (812) 309 58 32 (многоканальный)

**Факс:** 8 (812) 320-02-42

**Электронная почта:** [org@eplast1.ru](mailto:org@eplast1.ru)

**Адрес:** 198099, г. Санкт-Петербург, ул. Калинина, дом 2, корпус 4, литера А.