

SST-20-W

Specialty White LED

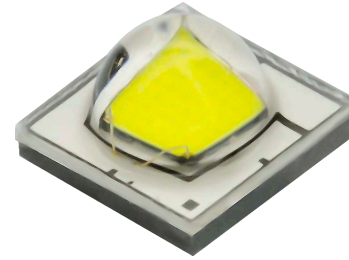

Table of Contents

General Considerations	2
Binning Structure	3
Chromaticity Bin Kit Codes	5
Ordering Information	7
Optical and Electrical Characteristics	8
Soldering Profile	12
Precautions for Use	13
Mechanical Dimensions	14
Reel & Box Packaging	16
Change History	19

Features:

- High Brightness Cool White LED with maximum output in excess of 900 lm@3A
- Available in 5000K, 5700K and 6500K, 70 CRI (typical) color points
- Compact monolithic emitter ideal for directional lighting applications with high uniformity
- Binned at 85 °C
- Typical efficacy 180 lm/W at 350 mA, Tj 85 °C
- Maximum drive current: 3 A
- Available with 2 industry standard soldering footprint configurations
- High thermal conductivity package - junction thermal resistance of only 1.6 °C/W
- Available with 120° viewing angle
- 8000V HBM ESD rating per JEDEC/ESDA STANDARD JS-001
- Electrically isolated thermal path
- RoHS and REACH compliant

Applications

- Horticulture grow light
- Automotive light bar, spotlight accessory, headlight
- Bicycle light
- Flashlight
- Torch
- Portable lighting

General Considerations

Environmental Considerations:

As a leading provider of solid-state Lighting solutions, Luminus implements strict substance control policies to ensure all of its products are environmentally friendly. As all Luminus LEDs, the SST-20-W series are compliant with the Restriction of Hazardous Substances Directive (RoHS) and REACH directives from the European Community.

Product Testing:

Every SST-20-W LED is fully production tested to ensure it meets the high quality standards customers have come to expect from Luminus products. Devices are binned to correlated values at 1500 mA, 20 msec pulse condition at $T_j = 85^{\circ}\text{C}$. Current and temperature curves are provided in this document allowing users to predict the LED performance and characteristics under their own driving and thermal conditions.

Reliability:

Luminus SST-20-W LED series are required to pass a rigorous suite of environmental and mechanical stress tests, including mechanical shock, vibration, temperature cycling and humidity. These tests ensure that the devices deliver high performance and achieve reliable long term operation in the automotive and other demanding environments. Please contact Luminus for further information.

Flux Binning Structure

SST-20-W LEDs are binned for luminous flux based on $I_f = 1500$ mA and 85 °C junction temperature (T_j) conditions.

Flux Bin (FF) ¹	Min. Flux (lm) 1500 mA, 85 °C	Max. Flux (lm) 1500 mA, 85 °C	Min. Flux (lm) 350 mA, 25 °C	Correlated Minimum Luminous Flux (lm) @ 85 °C ²			
				350 mA	700 mA	2000 mA	3000 mA
M3	705	745	228	207	381	876	1137
M2	665	705	215	195	359	827	1073
L5	620	665	200	182	335	771	1000
L4	585	620	189	172	316	727	944
L3	560	585	180	164	302	696	903
L2	530	560	172	155	286	659	855
K5	505	530	163	148	272	628	814
K4	475	505	153	139	256	591	766
K3	445	475	143	130	240	553	718
K2	415	445	134	122	224	516	669
J5	390	415	125	114	210	485	629

Note 1: Luminus maintains a +/- 6% tolerance on flux measurement.

Note 2: Correlated flux values at 350 mA, 700 mA, 2000 mA and 3000 mA are for reference only.

Forward Voltage Binning Structure

SST-20-W LEDs are binned for forward voltage based on $I_f = 1500$ mA and 85 °C junction temperature (T_j) conditions.

Voltage Bin ³	Minimum Voltage (V)	Maximum Voltage (V)
VH	2.5	2.7
VJ	2.7	2.9
VK	2.9	3.1
VL	3.1	3.3

Note 3: Individual voltage bins are not orderable.

Chromaticity Bin Definitions

CCT	Bin code	CIE-X	CIE-Y	Bin code	CIE-X	CIE-Y	Bin code	CIE-X	CIE-Y	Bin code	CIE-X	CIE-Y	
7500	AA	0.295	0.297	AB	0.292	0.306	AC	0.2984	0.3133	AD	0.2984	0.3133	
		0.292	0.306		0.2895	0.3135		0.2962	0.322		0.3048	0.3207	
		0.2984	0.3133		0.2962	0.322		0.3028	0.3304		0.3068	0.3113	
		0.3009	0.3042		0.2984	0.3133		0.3048	0.3207		0.3009	0.3042	
	AH	0.298	0.288	AE	0.2895	0.3135	AF	0.2962	0.322	AG	0.3037	0.2937	
		0.295	0.297		0.287	0.321		0.2937	0.3312		0.3009	0.3042	
		0.3009	0.3042		0.2937	0.3312		0.3005	0.3415		0.3068	0.3113	
		0.3037	0.2937		0.2962	0.322		0.3028	0.3304		0.3093	0.2993	
	6500	BA	0.3048	0.3207	BB	0.3028	0.3304	BC	0.3115	0.3391	BD	0.313	0.329
			0.313	0.329		0.3115	0.3391		0.3205	0.3481		0.3213	0.3373
			0.3144	0.3186		0.313	0.329		0.3213	0.3373		0.3221	0.3261
			0.3068	0.3113		0.3048	0.3207		0.313	0.329		0.3144	0.3186
BH		0.3068	0.3113	BE	0.3005	0.3415	BF	0.3099	0.3509	BG	0.3144	0.3186	
		0.3144	0.3186		0.3099	0.3509		0.3196	0.3602		0.3221	0.3261	
		0.3161	0.3059		0.3115	0.3391		0.3205	0.3481		0.3231	0.312	
		0.3093	0.2993		0.3028	0.3304		0.3115	0.3391		0.3161	0.3059	
5700		CA	0.3215	0.335	CB	0.3207	0.3462	CC	0.329	0.3538	CD	0.329	0.3417
			0.329	0.3417		0.329	0.3538		0.3376	0.3616		0.3371	0.349
			0.329	0.33		0.329	0.3417		0.3371	0.349		0.3366	0.3369
			0.3222	0.3243		0.3215	0.335		0.329	0.3417		0.3290	0.3300
	CH	0.3222	0.3243	CE	0.3196	0.3602	CF	0.329	0.369	CG	0.329	0.33	
		0.329	0.33		0.329	0.369		0.3381	0.3762		0.3366	0.3369	
		0.329	0.318		0.329	0.3538		0.3376	0.3616		0.3361	0.3245	
		0.3231	0.312		0.3207	0.3462		0.329	0.3538		0.3290	0.3180	
	5000	DA	0.3371	0.349	DB	0.3376	0.3616	DC	0.3463	0.3687	DD	0.3451	0.3554
			0.3451	0.3554		0.3463	0.3687		0.3551	0.376		0.3533	0.362
			0.344	0.3427		0.3451	0.3554		0.3533	0.362		0.3515	0.3487
			0.3366	0.3369		0.3371	0.349		0.3451	0.3554		0.3440	0.3427
DH		0.3366	0.3369	DE	0.3381	0.3762	DF	0.348	0.384	DG	0.344	0.3428	
		0.3366	0.3428		0.348	0.384		0.3571	0.3907		0.3515	0.3487	
		0.3366	0.3307		0.3463	0.3687		0.3551	0.376		0.3495	0.3339	
		0.3366	0.3245		0.3376	0.3616		0.3463	0.3687		0.3429	0.3307	

**SST-20-W Cool White Color Space
Plotted on the ANSI 1931 Curve**

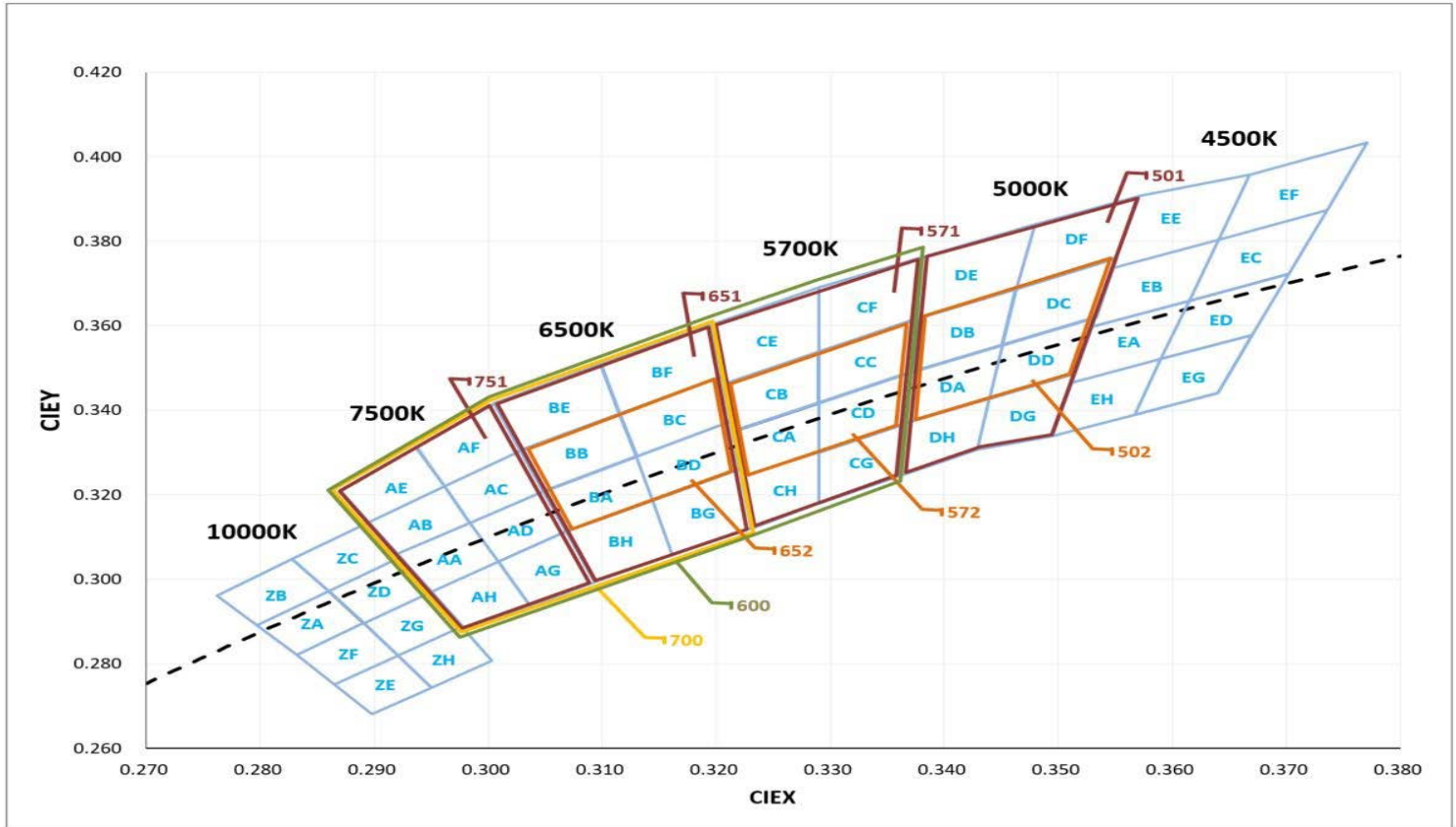

Chromaticity Bin Kit Codes

CCT	Bin Kit	Chromaticity Bins
5000K	501	DA, DB, DC, DD, DE, DF, DG, DH
	502	DA, DB, DC, DD
5700K	571	CA, CB, CC, CD, CE, CF, CG, CH
	572	CA, CB, CC, CD
6000K	600	AA, AB, AC, AD, AE, AF, AG, BH, BA, BB, BC, BD, BE, BF, BG, BH, CA, CB, CC, CD, CE, CF, CG, CH
6500K	651	BA, BB, BC, BD, BE, BF, BG, BH
	652	BA, BB, BC, BD
7500K	751	AA, AB, AC, AD, AE, AF, AG, AH

CRI Code Definitions

CRI Code	Min. CRI
S	65
E	70
F	80
G	90
H	95

Part Numbering Nomenclature

SST — 20 — <WXY> — <PAA(A)> — <FFCCC>

Product Family	LED Emission Area	Color	Package Configuration	Bin Kit
S: Surface mount S: Lensed T: Single monolithic emitter	20=2.0 mm ²	W: White X: Temperature C: Cool White D: Daylight White Y: CRI Code see page 5	P: Soldering pad configuration A type - see page 14 B type - see page 15 AA(A): Viewing angle 120°	See Tables FF = minimum flux bin CCC: Chromaticity bin kit

Ordering Part Numbers

CCT	Min. Flux Bin ¹	Min. Flux (lm)	Chromaticity Bin Kit Code ²	Solder Pad Config. ³	Viewing Angle	Ordering Part Numbers
5000K	L2	530	501	A	120	SST-20-WDS-A120-L2501
			501	B	120	SST-20-WDS-B120-L2501
			502	A	120	SST-20-WDS-A120-L2502
			502	B	120	SST-20-WDS-B120-L2502
	L3	560	501	A	120	SST-20-WDS-A120-L3501
			501	B	120	SST-20-WDS-B120-L3501
			502	A	120	SST-20-WDS-A120-L3502
			502	B	120	SST-20-WDS-B120-L3502
5700K	L2	530	571	A	120	SST-20-WDS-A120-L2571
			571	B	120	SST-20-WDS-B120-L2571
			572	A	120	SST-20-WDS-A120-L2572
			572	B	120	SST-20-WDS-B120-L2572
	L3	560	571	A	120	SST-20-WDS-A120-L3571
			571	B	120	SST-20-WDS-B120-L3571
			572	A	120	SST-20-WDS-A120-L3572
			572	B	120	SST-20-WDS-B120-L3572
6000K	L3	560	600	A	120	SST-20-WCS-A120-L3600
			600	B	120	SST-20-WCS-B120-L3600
	L4	585	600	A	120	SST-20-WCS-A120-L4600
			600	B	120	SST-20-WCS-B120-L4600
6500K	L3	560	651	A	120	SST-20-WCS-A120-L3651
			651	B	120	SST-20-WCS-B120-L3651
			652	A	120	SST-20-WCS-A120-L3652
			652	B	120	SST-20-WCS-B120-L3652
	L4	585	651	A	120	SST-20-WCS-A120-L4651
			651	B	120	SST-20-WCS-B120-L4651
			652	A	120	SST-20-WCS-A120-L4652
			652	B	120	SST-20-WCS-B120-L4652
7500K	L2	560	751	A	120	SST-20-WCS-A120-L2751
			751	B	120	SST-20-WCS-B120-L2751

Note 1: The minimum flux of each bin kit is determined by the minimum flux bin as defined on page 3. Higher flux bins are eligible to ship against shown bin kits and part numbers.

Note 2: See page 5 for chromaticity bin kit definitions.

Note 3: A and B versions correspond to soldering pad configurations. All product mechanical, electrical and optical specifications are otherwise identical.

Example: the part number SST-20-WCS-A120-L3651 refers to a part with type A package configuration, 120 degree viewing angle, flux greater than 560.

SST-20-W Product Characteristics¹

Parameter		Symbol	Minimum	Typical				Maximum	Unit
				5000K	5700K	6500K	7500K		
Forward Current at test		I_F		1500					mA
Forward Voltage		V_F	2.7	3.0				3.3	V
Luminous Flux		ϕ_v		540	560	585	590		lm
Radiometric Flux ⁴		ϕ_e		533	548	559	565		mW
Photosynthetic Photon Flux (400nm to 700nm window) ⁴		PPF		2.37	2.43	2.44	2.45		$\mu\text{mol/s}$
Photosynthetic Photon Flux Efficacy ⁴		PPF/W		2.42	2.48	2.49	2.5		$\mu\text{mol/J}$
Viewing Angle	A120, B120	$2\theta_{1/2}$		120					Degrees
Color Rendering Index		CRI	65	70					
Forward Current (CW) ²		I_{fmin}, I_{fmax}	0.2					3	A
Maximum Surge Current		I_{f-smax}						4	A
Maximum Reverse Current ³		I_{rev}						N.A.	
LED Junction Temperature		T_j						150	$^{\circ}\text{C}$
ESD withstand Voltage HBM Per JEDEC/ESDA STANDARD JS-001		V_{HBM}	8000						V
ESD withstand Voltage CDM Per JEDEC/ESDA STANDARD JS-002		V_{CDM}	1000						V
Operating Temperature		T_{OPR}	- 40					100	$^{\circ}\text{C}$
Thermal resistance junction to case (electrical)		$R_{\theta_{JC-EL}}$		1.6					$^{\circ}\text{C/W}$

Note 1: Values are at 85°C unless otherwise noted

Note 2: Sustained operation at maximum current will result in shortened lifetime.

Note 3: Not designed for reverse voltage operation.

Note 4: Values are at 350 mA, T_j 25 °C

Optical & Electrical Characteristics

Relative Luminous Flux vs. Forward Current

$\phi_v/\phi_v(1.5A)$ Single Pulse 20ms $T_j = 85^\circ C$

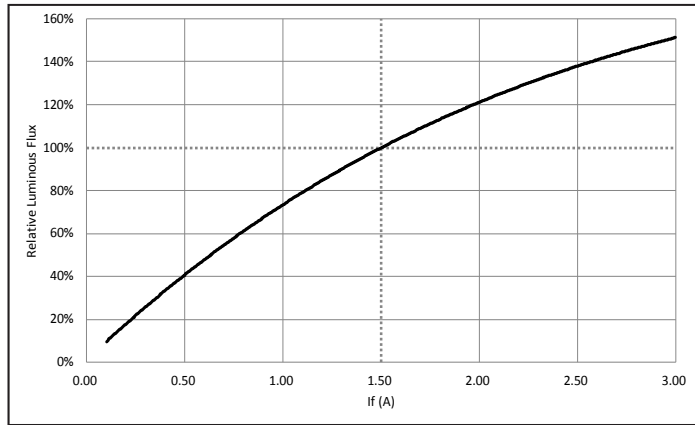

Relative Luminous Flux vs. Temperature (Tj)

$\phi_v/\phi_v(85^\circ C)$ Single Pulse 20ms $I_f = 1.5A$

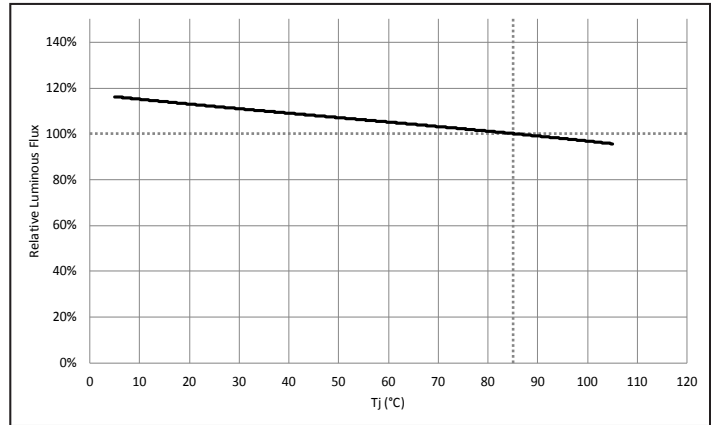

Forward Voltage vs. Forward Current

$V_f(I_f)$ Single Pulse 20ms $T_j = 85^\circ C$

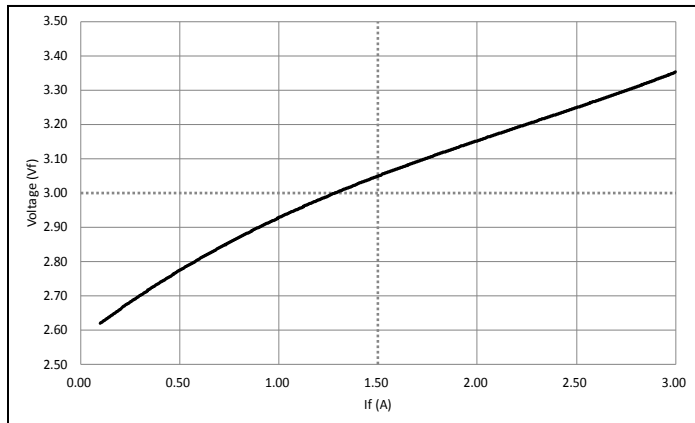

Relative Forward Voltage vs. Temperature (Tj)

$\Delta V_f = V(T_j) - V(85^\circ C)$ Single Pulse 20ms $I_f = 1.5A$

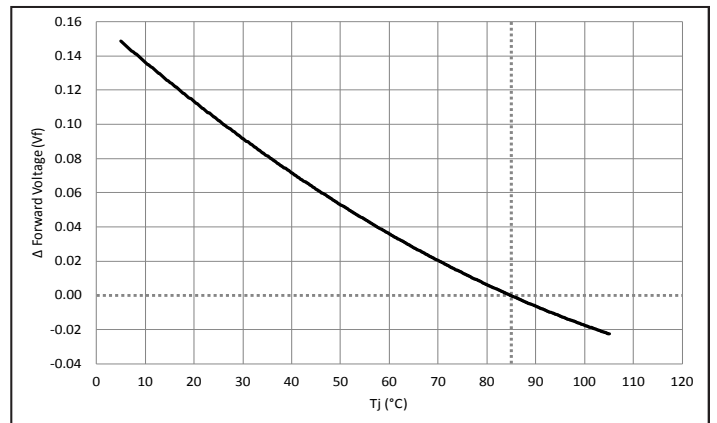

Relative Chromaticity vs. Forward Current

$\Delta CIE_{x,y} = CIE_{x,y}(I_f) - CIE_{x,y}(1.5A)$, Single Pulse 20ms $T_j = 85^\circ C$

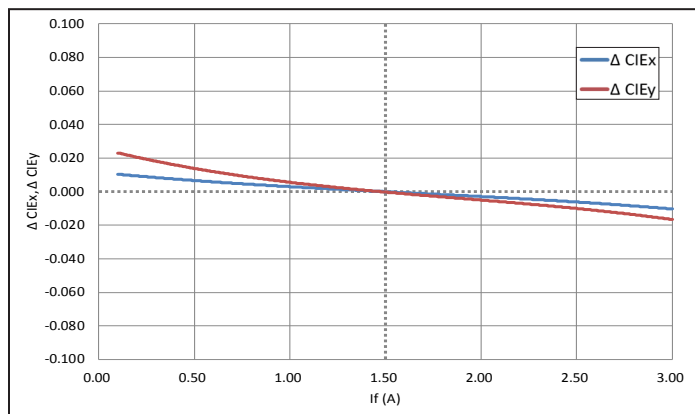

Relative Chromaticity vs. Temperature (Tj)

$\Delta CIE_{x,y} = CIE_{x,y}(T_j) - CIE_{x,y}(85^\circ C)$ Single Pulse 20ms $I_f = 1.5A$

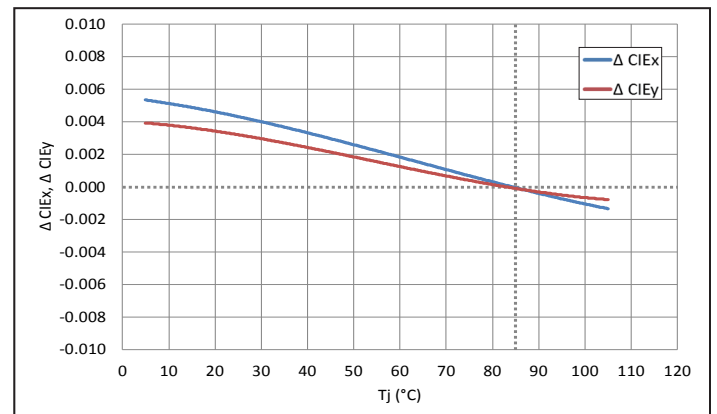

Optical & Electrical Characteristics

Typical Relative Radiant Power (%)¹

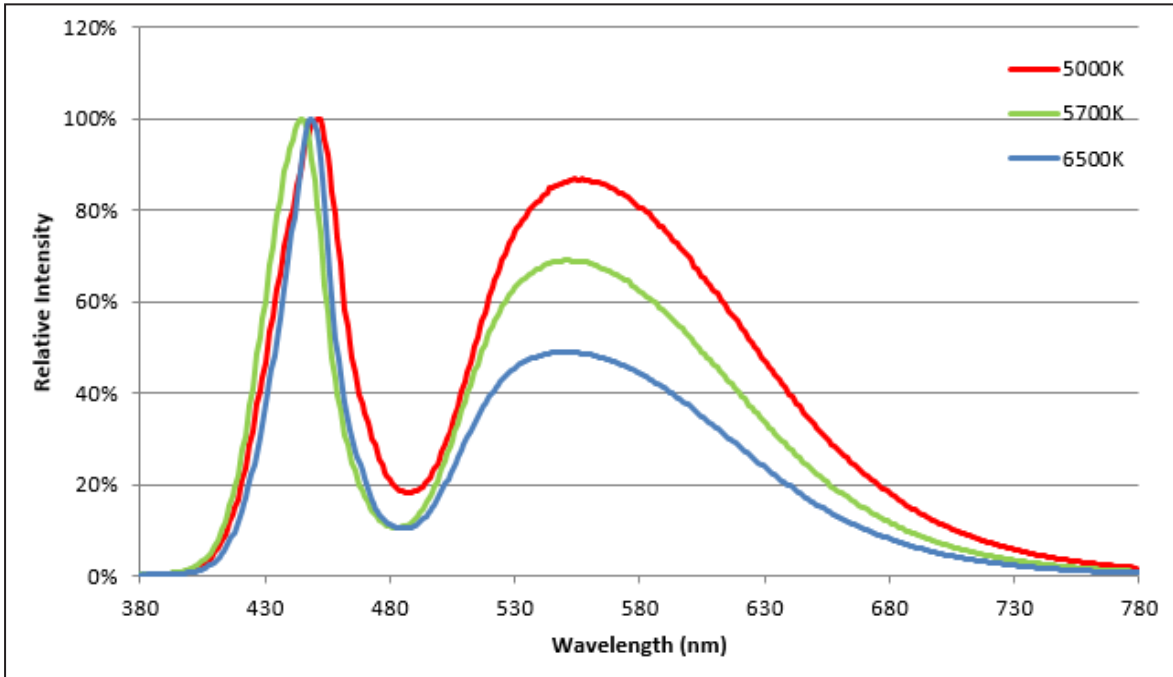

Typical Angular Pattern of Radiant Power Types A120 and B120²

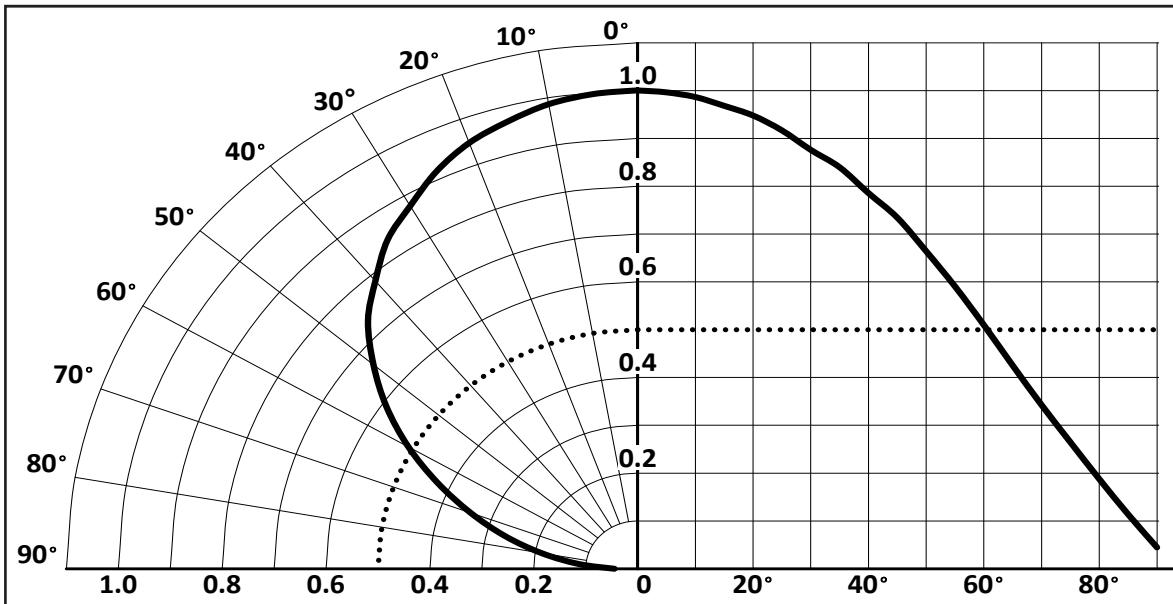

Note 1: Relative radiant power measurements were made at 1.5 A, 85 °C.

Note 2: Angular pattern measurements were made at 1.5 A, 25 °C.

Thermal Resistance

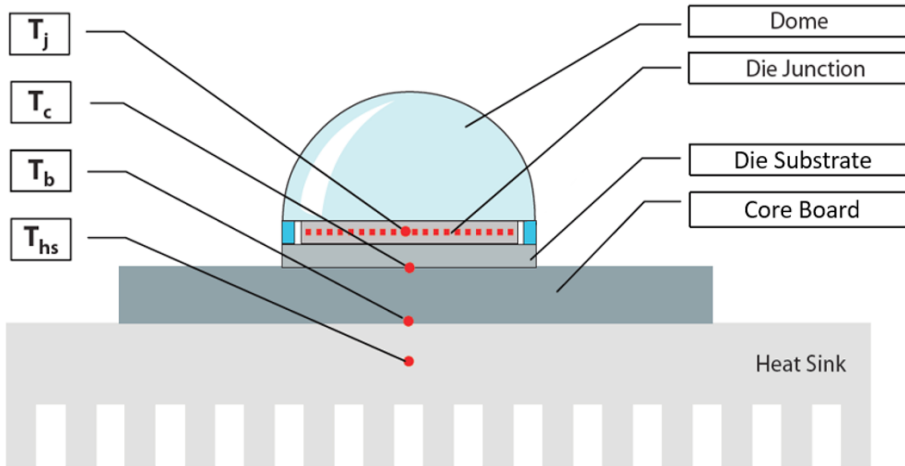

Typical Thermal Resistance

R_{j-c}^1	1.60 °C/W
R_{j-b}^1	2.54 °C/W

Note 1: Thermal resistance values are based on rapid thermal transient testing results.

Note 2: Thermal resistance is measured using a SAC305 solder and a Cu-pedestal MCPCB.

Note 3: The values represent the electrical thermal resistance @2A operation @25deg.

Drive Current (A) vs. T case (deg C)

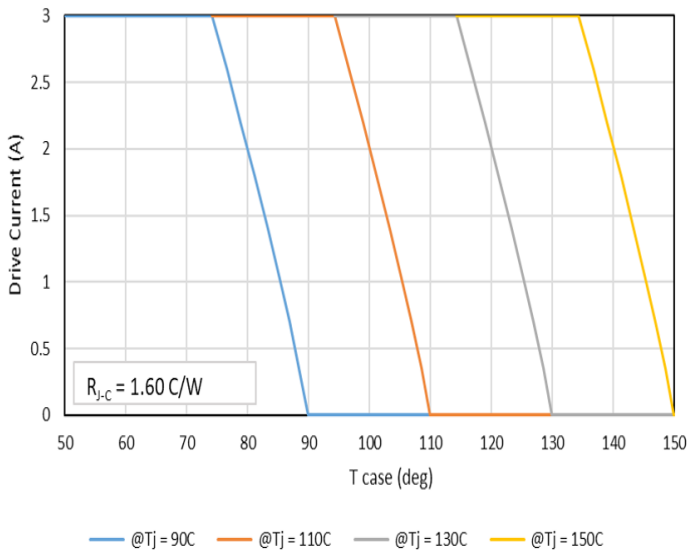

Drive Current (A) vs. T board (deg C)

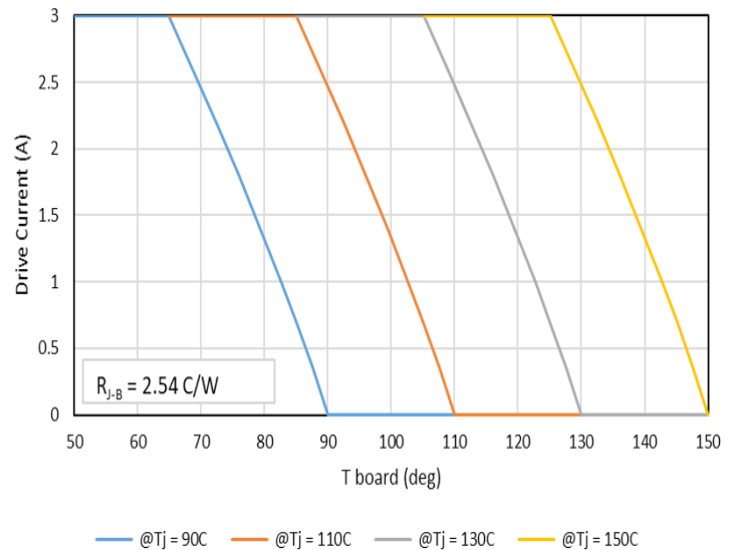

Soldering Profile

SAC 305 Reflow Profile Window For Low Density Boards

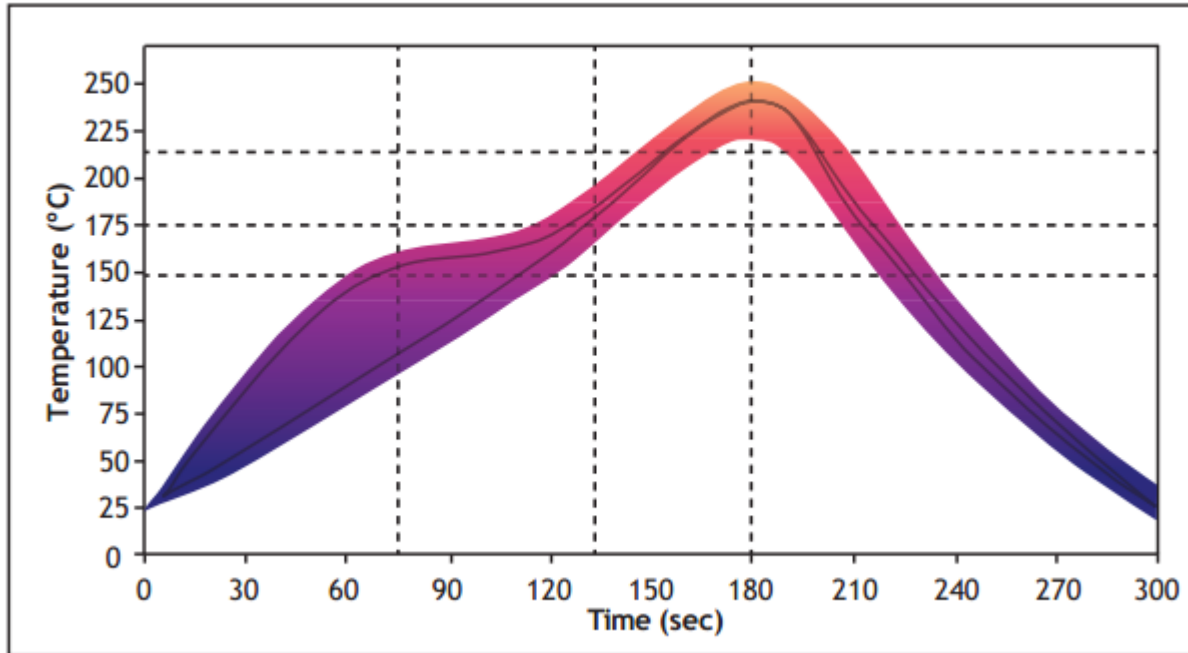

Lead free solder guideline for low density boards

Solder Profile Stage	Lead-Free Solder	Lead-based Solder
Profile length, Ambient to Peak	2.75 - 3.5 minutes	2.75 - 3.5 minutes
Time Maintained Above: Temperature	217 °C	183 °C
Time Maintained Above: Time	30 - 60 seconds	30 - 60 seconds
Cooldown Rate	≤4° C/sec	≤4° C/sec
Cooldown Duration	45 ± 15 sec	45 ± 15 sec

Note 1: Temperatures are taken and monitored at the component copper layer.

Note 2: Optimum profile may differ due to oven type, circuit board or assembly layout.

Note 3: Recommended lead free, no-clean solder: AIM NC254-SAC305.

Note 4: Refer to APN-001473 soldering and handling application note for additional solder profiles and details.

Note 5: MSL- Level 2A (Glass Lens); MSL Level 1 (Over Molded Design)

Precautions for Use

Storage:

SST-20-W LEDs have an MSL 3 moisture sensitivity rating and should be handled per JEDEC J-STD-020. In addition, Luminus recommends the following storage guidelines.

1. The recommended storage condition is between 5 °C and 30 °C and relative humidity less than or equal to 85% RH in its original package.

The LED's electrode and leadframe are a silver plated copper alloy. The silver surface may be affected by its environment. Please avoid conditions which may cause the LEDs to corrode or become discolored. The corrosion or discoloration might lower the solderability or affect the optical characteristics of the device.

Please avoid rapid transitions in ambient temperature, especially in high humidity environments where condensation can occur.

Static Electricity:

1. The products are sensitive to static electricity and care should be taken when handling them.
2. Static electricity or surge voltage will damage the LEDs. It is recommended to wear an anti-electrostatic wristband or anti-electrostatic gloves when handling the LEDs.
3. All devices, equipment and machinery must be properly grounded. It is recommended that measures be taken against surge voltage to the equipment that mounts the LEDs.

Vision Advisory

WARNING: Looking at an exposed LED during operation can result in eye injury. This LED products has been classified as Risk Group 2 for blue light hazard according to the IEC 62471.

Mechanical Dimensions¹

A120 Package Configuration

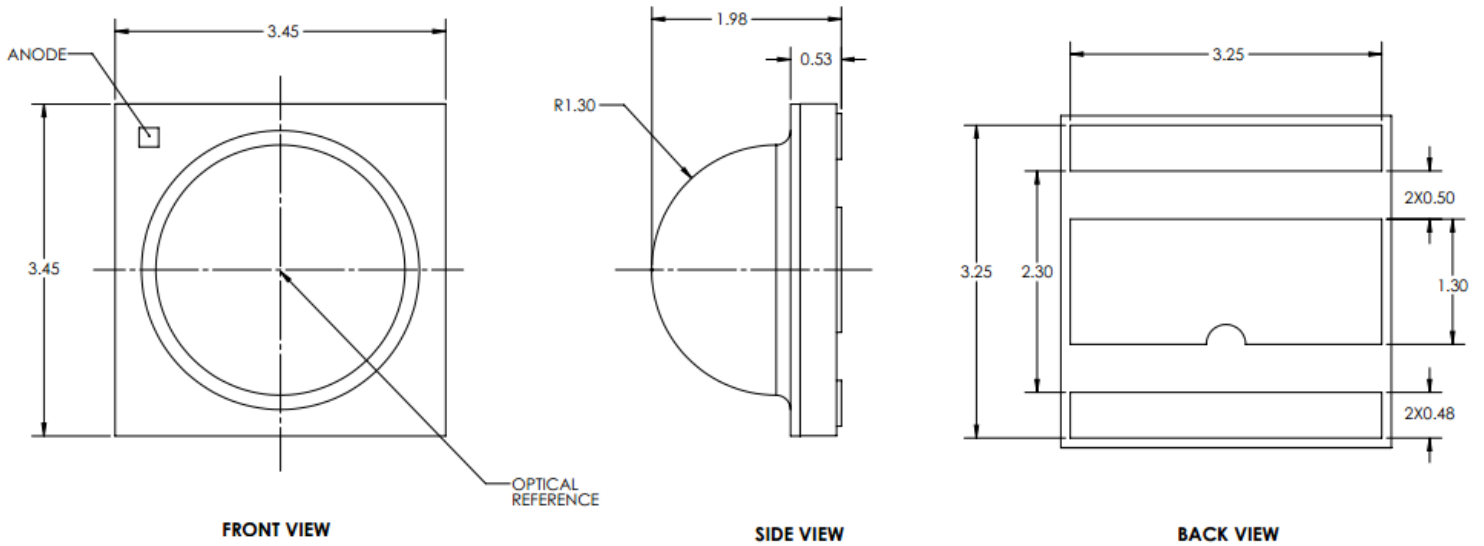

Recommended PCB Solder Pad and Stencil Pattern¹

A120 Package Configuration

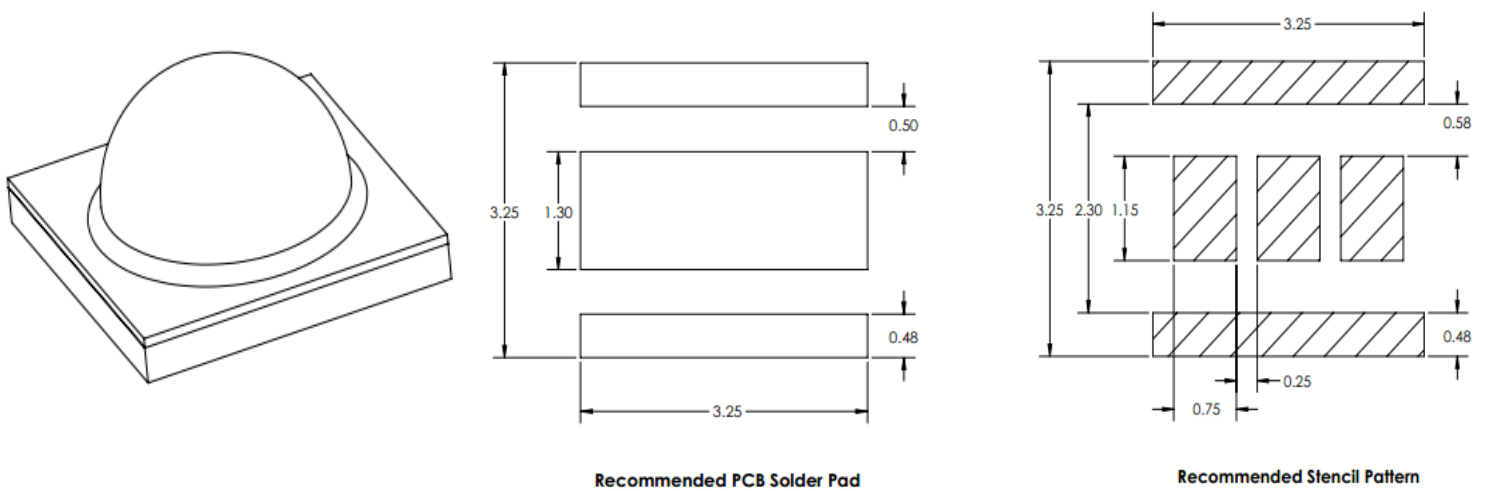

Note 1: Dimensions are in millimeters +/- 0.13 mm

Mechanical Dimensions¹

B120 Package Configuration

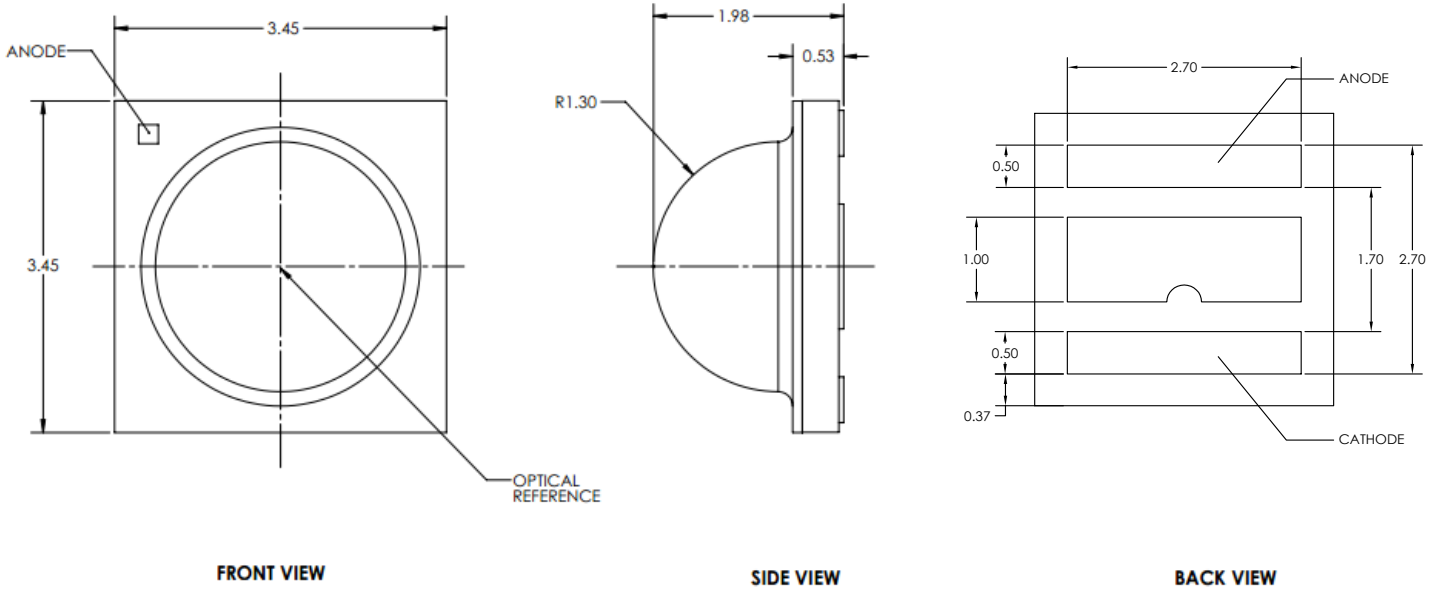

Recommended PCB Solder Pad and Stencil Pattern¹

B120 Package Configuration

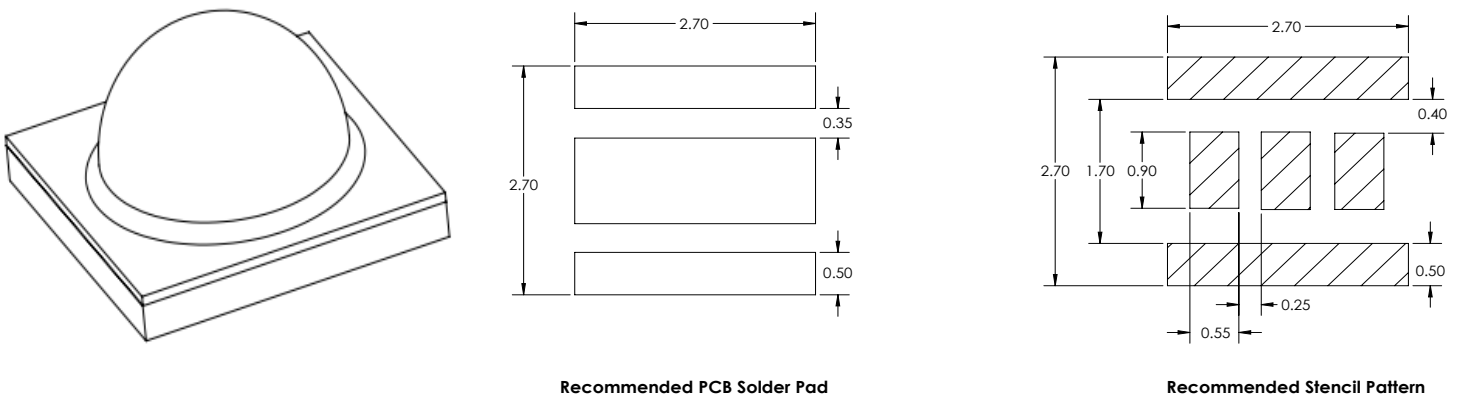

Note 1: Dimensions are in millimeters +/- 0.13 mm

Tape and Reel - A120 and B120 Package Configurations¹

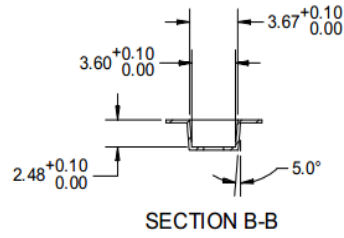
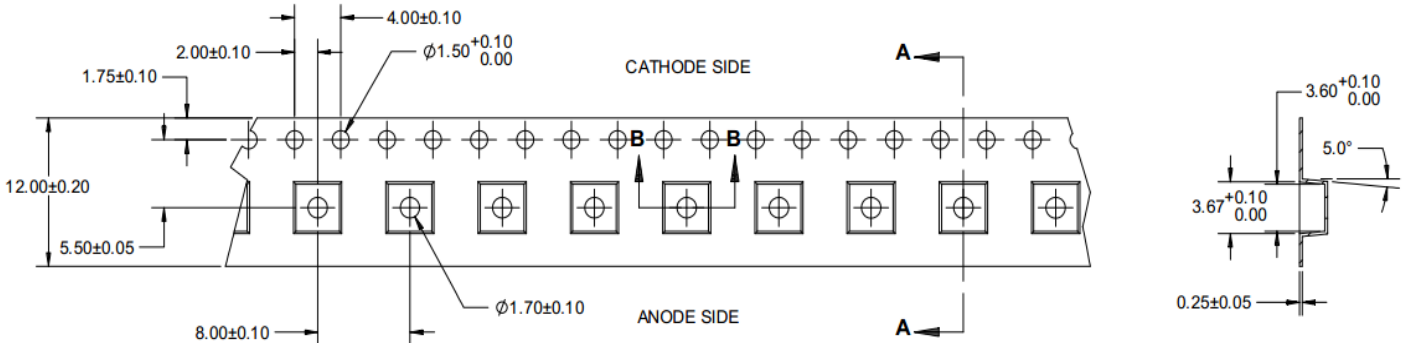

SECTION A-A

NOTES:

1. FINAL TAPE AND REEL PACKAGING MUST MEET THE REQUIREMENTS OF JEDEC-STD-033, LEVEL 2A.
2. LEAVE 304.8 mm [12.00 in] OF TYPE EMPTY FOR LEAD IN (38 EMPTY POCKETS)
3. LEAVE 457.2 mm [18.00 in] OF TYPE EMPTY FOR TRAILER (57 EMPTY POCKETS)
4. MUST COMPLY TO EIA-481-C-2003
5. EACH REEL CONTAINS 1,000 UNITS

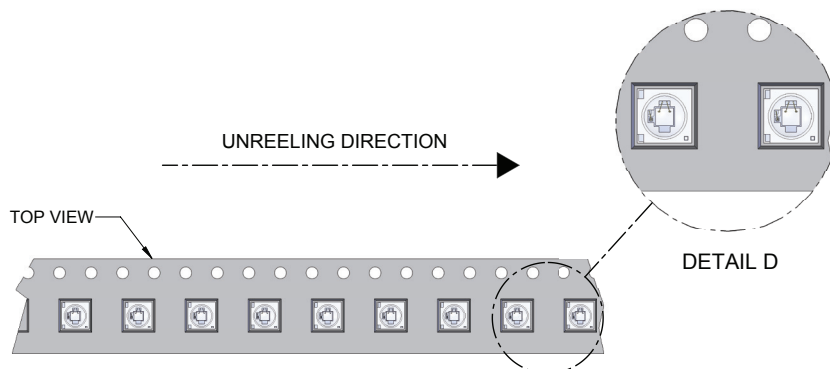
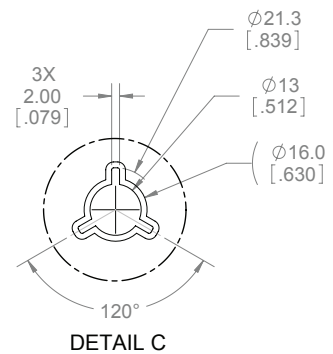
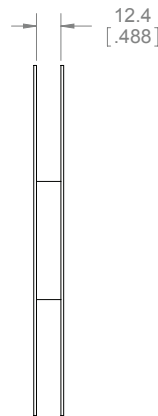
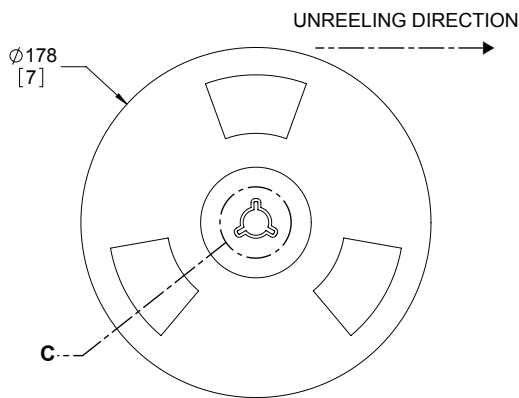

Note 1: Dimensions are in millimeters

Reel Packaging

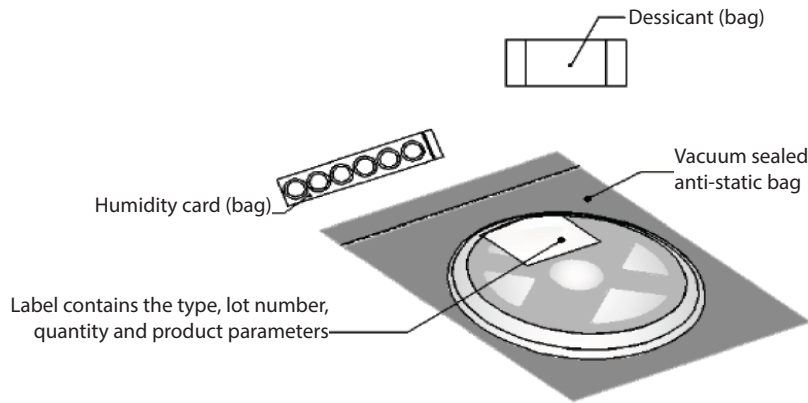

Reel Label

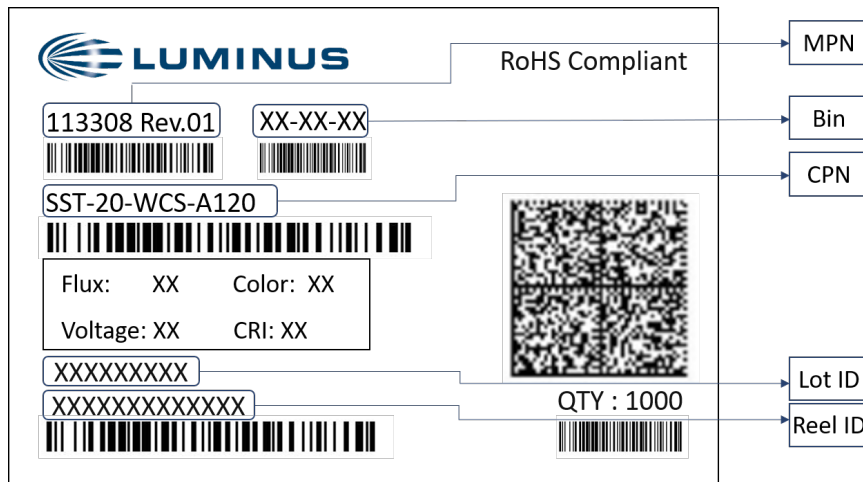

Label Fields:

- CPN: Luminus ordering part number
- MPN: For Luminus internal use
- Qty: On reel
- Flux: Bin as defined on page 3
- Voltage: Bin as defined on page 3
- Color: Bin as defined on page 4
- Mfg Info: For Luminus internal use

Shipping Label

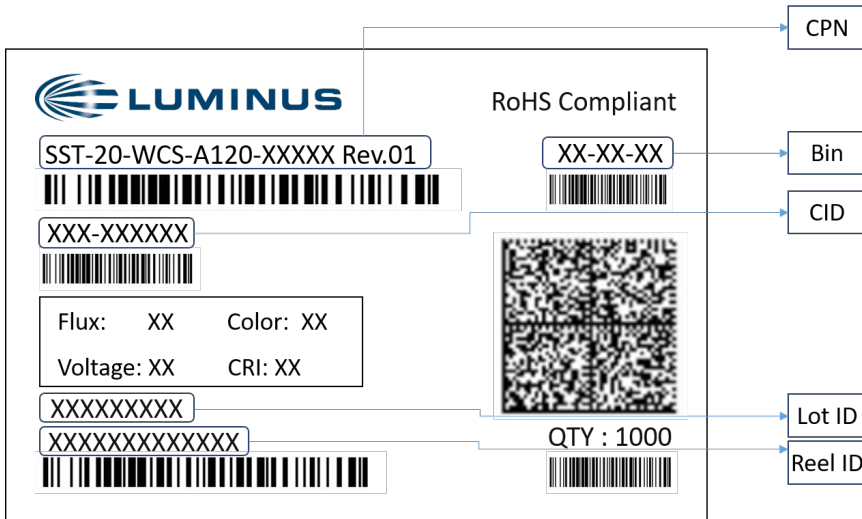

Label Fields:

- CPN: Luminus ordering part number
- CID: Customer ID
- Qty: On reel
- Flux: Bin as defined on page 3
- Voltage: Bin as defined on page 3
- Color: Bin as defined on page 4

Box Packaging Information

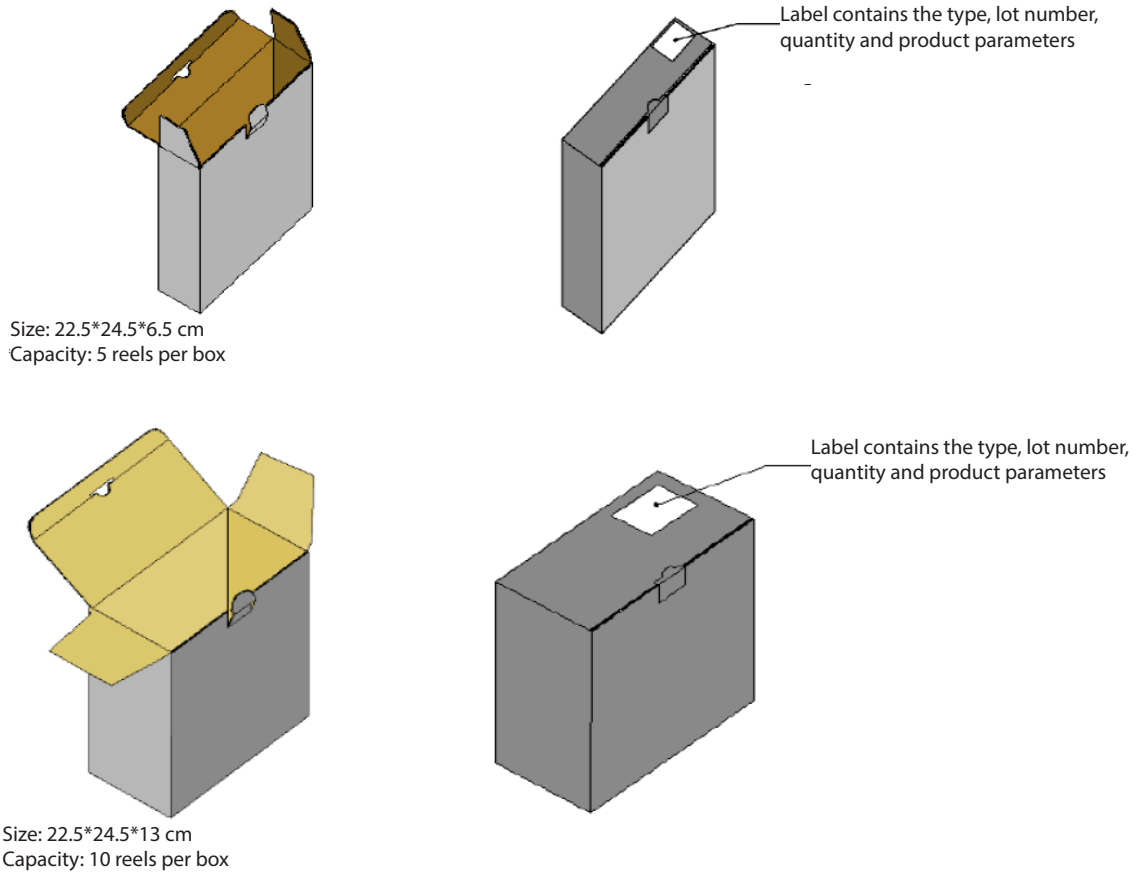

History of Changes

Revision	Date	Description of Change
01	9/17/2017	Initial data sheet. Includes SST-20-WCS-A130 and SST-20-WCS-B130 products.
02	1/8/2018	- Change binning current to 1.5 A. Updated calculated values and characterization plot accordingly. - Added Photosynthetic Photon Flux and Photosynthetic Photon Flux Efficacy at 350 mA. - Editorial and general parametric updates.
03	3/2/2018	- Remove "Preliminary". - Editorial corrections across the document.
04	5/4/2018	- Updated typical flux, Vf and lm/W. - Added new color points: 5000K and 5700K (Preliminary status). - Added CRI code definitions. - Added shipping label & label description.
05	6/4/2018	- Updated 5000K, 5700K, 7500K min. flux bin, Radiometric Flux, Photosynthetic Photon Flux, Photosynthetic Photon Flux Efficacy. - Remove the mark of "Optical Reference".
06	3/25/2019	- Updated the graph of typical relative radiant power.
07	3/23/2020	- Updated ordering code and other information.
08	3/26/2020	- Added flux bin.

The products, their specifications and other information appearing in this document are subject to change by Luminus Devices without notice. Luminus Devices assumes no liability for errors that may appear in this document, and no liability otherwise arising from the application or use of the product or information contained herein. None of the information provided herein should be considered to be a representation of the fitness or suitability of the product for any particular application or as any other form of warranty. Luminus Devices' product warranties are limited to only such warranties as accompany a purchase contract or purchase order for such products. Nothing herein is to be construed as constituting an additional warranty. No information contained in this publication may be considered as a waiver by Luminus Devices of any intellectual property rights that Luminus Devices may have in such information.

This product is protected by U.S. Patents 6,831,302; 7,074,631; 7,083,993; 7,084,434; 7,098,589; 7,105,861; 7,138,666; 7,166,870; 7,166,871; 7,170,100; 7,196,354; 7,211,831; 7,262,550; 7,274,043; 7,301,271; 7,341,880; 7,344,903; 7,345,416; 7,348,603; 7,388,233; 7,391,059 Patents Pending in the U.S. and other countries.



Компания «ЭлектроПласт» предлагает заключение долгосрочных отношений при поставках импортных электронных компонентов на взаимовыгодных условиях!

Наши преимущества:

- Оперативные поставки широкого спектра электронных компонентов отечественного и импортного производства напрямую от производителей и с крупнейших мировых складов;
- Поставка более 17-ти миллионов наименований электронных компонентов;
- Поставка сложных, дефицитных, либо снятых с производства позиций;
- Оперативные сроки поставки под заказ (от 5 рабочих дней);
- Экспресс доставка в любую точку России;
- Техническая поддержка проекта, помощь в подборе аналогов, поставка прототипов;
- Система менеджмента качества сертифицирована по Международному стандарту ISO 9001;
- Лицензия ФСБ на осуществление работ с использованием сведений, составляющих государственную тайну;
- Поставка специализированных компонентов (Xilinx, Altera, Analog Devices, Intersil, Interpoint, Microsemi, Aeroflex, Peregrine, Syfer, Eurofarad, Texas Instrument, Miteq, Cobham, E2V, MA-COM, Hittite, Mini-Circuits, General Dynamics и др.);

Помимо этого, одним из направлений компании «ЭлектроПласт» является направление «Источники питания». Мы предлагаем Вам помощь Конструкторского отдела:

- Подбор оптимального решения, техническое обоснование при выборе компонента;
- Подбор аналогов;
- Консультации по применению компонента;
- Поставка образцов и прототипов;
- Техническая поддержка проекта;
- Защита от снятия компонента с производства.



Как с нами связаться

Телефон: 8 (812) 309 58 32 (многоканальный)

Факс: 8 (812) 320-02-42

Электронная почта: org@eplast1.ru

Адрес: 198099, г. Санкт-Петербург, ул. Калинина, дом 2, корпус 4, литера А.