



Chip Beads

For power line

MPZ series

MPZ0603	0603[0201 inch]*
MPZ1005	1005[0402 inch]
MPZ1608	1608[0603 inch]
MPZ2012	2012[0805 inch]

* Dimensions Code JIS[EIA]

REMINDERS FOR USING THESE PRODUCTS

Before using these products, be sure to request the delivery specifications.

SAFETY REMINDERS

Please pay sufficient attention to the warnings for safe designing when using these products.

REMINDERS

- The storage period is less than 12 months. Be sure to follow the storage conditions (Temperature: 5 to 40°C, Humidity: 10 to 75% RH or less).
If the storage period elapses, the soldering of the terminal electrodes may deteriorate.
- Do not use or store in locations where there are conditions such as gas corrosion (salt, acid, alkali, etc.).
- Before soldering, be sure to preheat components.
The preheating temperature should be set so that the temperature difference between the solder temperature and chip temperature does not exceed 150°C.
- Soldering corrections after mounting should be within the range of the conditions determined in the specifications.
If overheated, a short circuit, performance deterioration, or lifespan shortening may occur.
- When embedding a printed circuit board where a chip is mounted to a set, be sure that residual stress is not given to the chip due to the overall distortion of the printed circuit board and partial distortion such as at screw tightening portions.
- Self heating (temperature increase) occurs when the power is turned ON, so the tolerance should be sufficient for the set thermal design.
- Carefully lay out the coil for the circuit board design of the non-magnetic shield type.
A malfunction may occur due to magnetic interference.
- Use a wrist band to discharge static electricity in your body through the grounding wire.
- Do not expose the products to magnets or magnetic fields.
- Do not use for a purpose outside of the contents regulated in the delivery specifications.
- The products listed on this catalog are intended for use in general electronic equipment (AV equipment, telecommunications equipment, home appliances, amusement equipment, computer equipment, personal equipment, office equipment, measurement equipment, industrial robots) under a normal operation and use condition.
The products are not designed or warranted to meet the requirements of the applications listed below, whose performance and/or quality require a more stringent level of safety or reliability, or whose failure, malfunction or trouble could cause serious damage to society, person or property.
If you intend to use the products in the applications listed below or if you have special requirements exceeding the range or conditions set forth in the each catalog, please contact us.

- (1) Aerospace/Aviation equipment
- (2) Transportation equipment (cars, electric trains, ships, etc.)
- (3) Medical equipment
- (4) Power-generation control equipment
- (5) Atomic energy-related equipment
- (6) Seabed equipment
- (7) Transportation control equipment

- (8) Public information-processing equipment
- (9) Military equipment
- (10) Electric heating apparatus, burning equipment
- (11) Disaster prevention/crime prevention equipment
- (12) Safety equipment
- (13) Other applications that are not considered general-purpose applications

When designing your equipment even for general-purpose applications, you are kindly requested to take into consideration securing protection circuit/device or providing backup circuits in your equipment.

Chip Beads

For power line

Product compatible with RoHS directive
Halogen-free
Compatible with lead-free solders

Overview of the MPZ Series

FEATURES

- Noise reduction solution for power supply lines.
- Compared to the conventional MMZ Series, has low direct current resistance for compatibility with large currents, optimal for low power consumption.
- Lineup includes 4 sizes from 0603 to 2012.
- Achieves various frequency characteristics by using 5 materials with different features.
- Multilayer integration monolithic structure makes it highly reliable.
- There is no directivity.

APPLICATION

- Smart phones, tablets, portable memory audio devices, various modules, PCs, note PCs, TVs, STBs, Blu-ray recorders, DSCs, and DVCs
- Power supply line noise removal for game machines, smart grids, industrial equipment, etc.

PART NUMBER CONSTRUCTION

MPZ	0603	S	220	C	T	□□□	
Series name	LxWxT Dimensions (mm)		Impedance (Ω) at 100MHz		Characteristic type	Packaging style	Internal code
0603	0.6x0.3x0.3		220 22		C	T Taping	
1005	1.0x0.5x0.5				A		
1608	1.6x0.8x0.6				B		
	1.6x0.8x0.8						
2012	2.0x1.25x0.85						

OPERATING TEMPERATURE RANGE, PACKAGE QUANTITY, PRODUCT WEIGHT

Type	Temperature range		Package quantity	Individual weight
	Operating temperature*	Storage temperature**		
	(°C)	(°C)	(pieces/reel)	(mg)
MPZ0603	-55 to +125	-55 to +125	15,000	0.3
MPZ1005	-40 to +85	-40 to +85	10,000	1
MPZ1608	t=0.6mm	-55 to +125	4,000	3
	t=0.8mm	-55 to +125	4,000	4
MPZ2012	-55 to +125	-55 to +125	4,000	8

* Operating temperature range includes self-temperature rise.

** The Storage temperature range is for after the circuit board is mounted.

- RoHS Directive Compliant Product: See the following for more details related to RoHS Directive compliant products. <http://www.tdk.co.jp/rohs/>
- Halogen-free: Indicates that Cl content is less than 900ppm, Br content is less than 900ppm, and that the total Cl and Br content is less than 1500ppm.

• All specifications are subject to change without notice.

Overview of the MPZ Series

RECOMMENDED REFLOW PROFILE

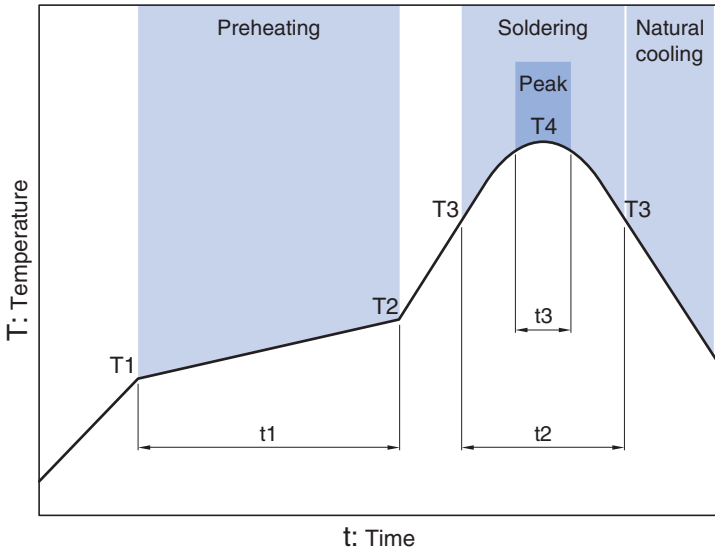

Preheating			Soldering		Peak	
Temp.	Temp.	Time	Temp.	Time	Temp.	Time
T1	T2	t1	T3	t2	T4	t3
150°C	180°C	60 to 120s	230°C	30 to 60s	250 to 260°C	10s

• All specifications are subject to change without notice.

Overview of the MPZ Series

■ MATERIAL CHARACTERISTICS

B material: This type is perfectly suited for fast digital signals. By equalizing R components and X components that beads possess at a frequency of 5MHz, it is able to suppress overshooting, undershooting and ringing of fast digital signals.

R material: For wide frequency applications calling for broad impedance characteristics.

For digital signal line applications calling requiring good waveform integrity. Impedance values selected for effectiveness at 10 to 200MHz.

S material: Standard type that features impedance characteristics similar to those of a typical ferrite core.

For signal line applications in which the blocking region is near 100MHz. Impedance values selected for effectiveness at 40 to 300MHz.

Y material: High frequency range type intended for the 100MHz region and above.

For signal line applications in which the signal frequency is far from the cutoff frequency. Impedance values selected for effectiveness at 80 to 400MHz.

D material: For applications calling for low insertion loss at low frequencies and sharply increasing impedance at high frequencies.

Designed for high impedance at high frequencies (300MHz to 1GHz) for signal line applications.

■ TYPICAL MATERIAL IMPEDANCE CHARACTERISTICS

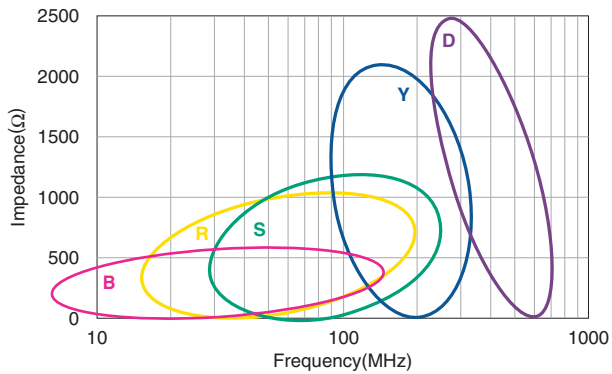

MPZ series

MPZ0603 Type



■ SHAPE & DIMENSIONS

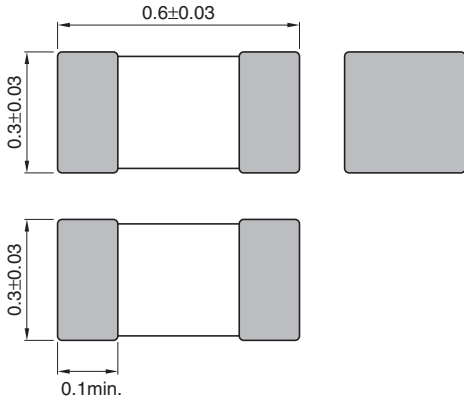

Dimensions in mm

■ RECOMMENDED LAND PATTERN

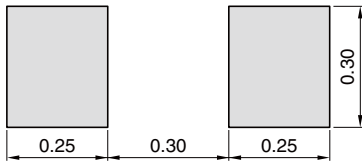

Dimensions in mm

• All specifications are subject to change without notice.

MPZ series **MPZ0603 Type**

■ ELECTRICAL CHARACTERISTICS

□ CHARACTERISTICS SPECIFICATION TABLE

Impedance [100MHz] (Ω)	Tolerance	DC resistance (Ω)max.	Rated current (mA)max.	Part No.
22	±25%	0.065	1000	MPZ0603S220CT□□□
33	±25%	0.090	750	MPZ0603S330CT□□□
47	±25%	0.120	500	MPZ0603S470CT□□□

○ Measurement equipment

Measurement item	Product No.	Manufacturer
Impedance	E4991A+16197	Agilent Technologies
DC resistance	Type-7556	Yokogawa

* Equivalent measurement equipment may be used.

MPZ series **MPZ0603 Type**

■ ELECTRICAL CHARACTERISTICS

□ Z VS. FREQUENCY CHARACTERISTICS (BY SERIES)

MPZ0603S SERIES

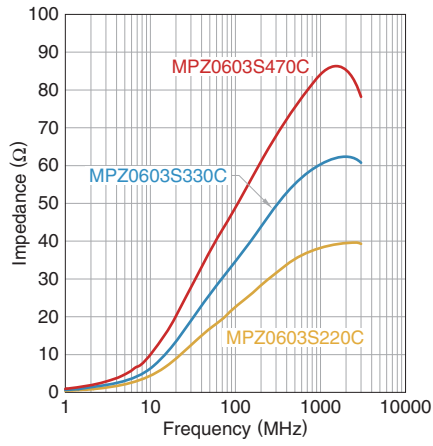

• All specifications are subject to change without notice.

MPZ series **MPZ0603 Type**

■ ELECTRICAL CHARACTERISTICS

□ Z, X, R VS. FREQUENCY CHARACTERISTICS

MPZ0603S220C

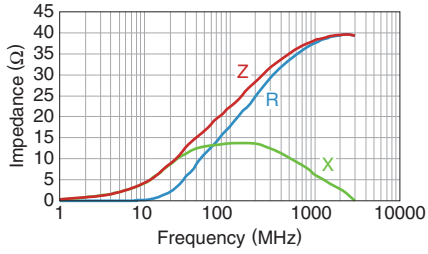

MPZ0603S330C

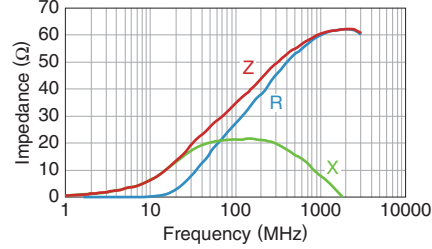

MPZ0603S470C

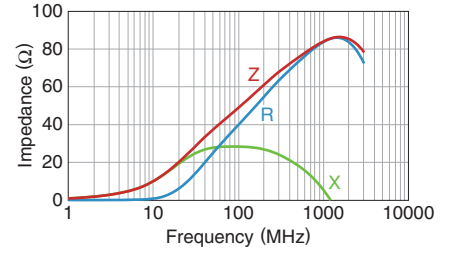

• All specifications are subject to change without notice.

MPZ series

MPZ1005 Type



SHAPE & DIMENSIONS

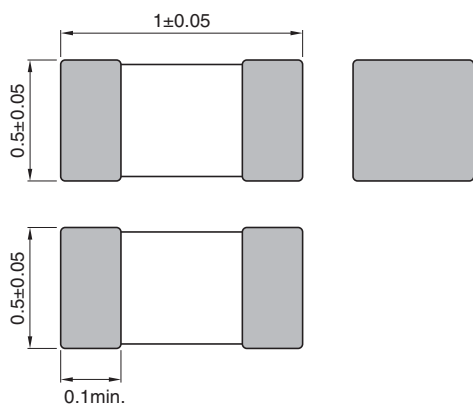

Dimensions in mm

RECOMMENDED LAND PATTERN

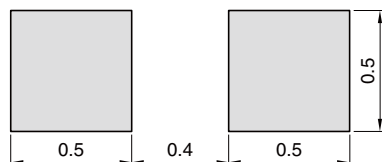

Dimensions in mm

MPZ series **MPZ1005 Type**

■ ELECTRICAL CHARACTERISTICS

□ CHARACTERISTICS SPECIFICATION TABLE

Impedance [100MHz] (Ω)	Tolerance	DC resistance (Ω)max.	Rated current (A)max.	Part No.
10	$\pm 5\Omega$	0.025	2.0	MPZ1005S100CT□□□
30	$\pm 10\Omega$	0.035	1.7	MPZ1005S300CT□□□
60	$\pm 25\%$	0.060	1.5	MPZ1005S600CT□□□
120	$\pm 25\%$	0.090	1.2	MPZ1005S121CT□□□
90	$\pm 25\%$	0.100	1.2	MPZ1005Y900CT□□□

○ Measurement equipment

Measurement item	Product No.	Manufacturer
Impedance	E4991A+16192A	Agilent Technologies
DC resistance	Type-7556	Yokogawa

* Equivalent measurement equipment may be used.

MPZ series MPZ1005 Type

ELECTRICAL CHARACTERISTICS

Z VS. FREQUENCY CHARACTERISTICS (BY SERIES)

MPZ1005S SERIES

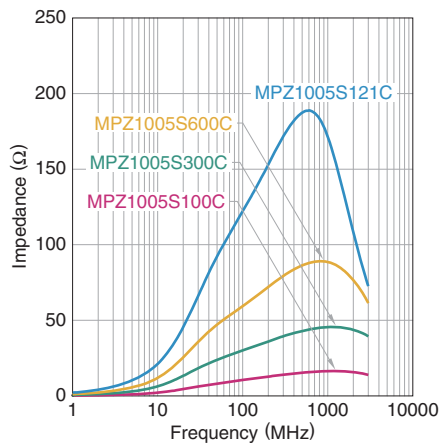

MPZ1005Y SERIES

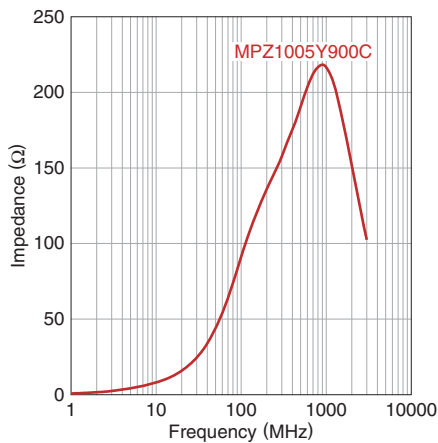

• All specifications are subject to change without notice.

MPZ series MPZ1005 Type

ELECTRICAL CHARACTERISTICS

Z, X, R VS. FREQUENCY CHARACTERISTICS

MPZ1005S100C

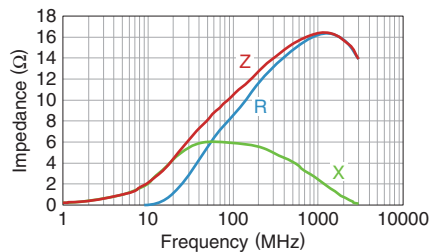

MPZ1005S300C

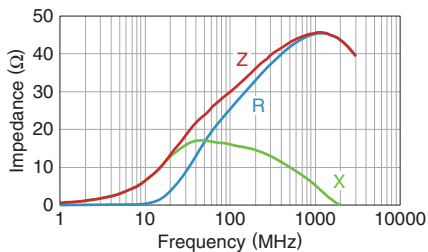

MPZ1005S600C

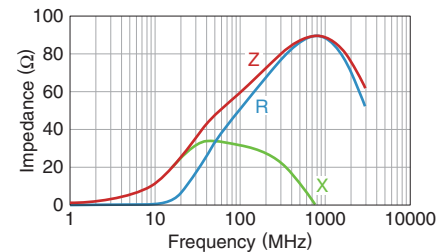

MPZ1005S121C

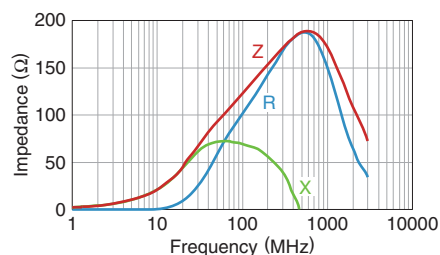

MPZ1005Y900C

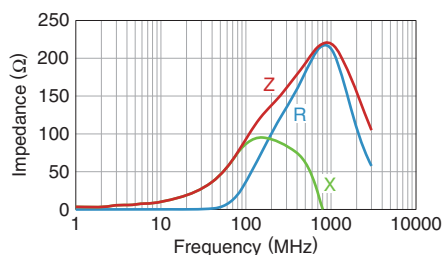

• All specifications are subject to change without notice.

MPZ series

MPZ1608 Type



SHAPE & DIMENSIONS

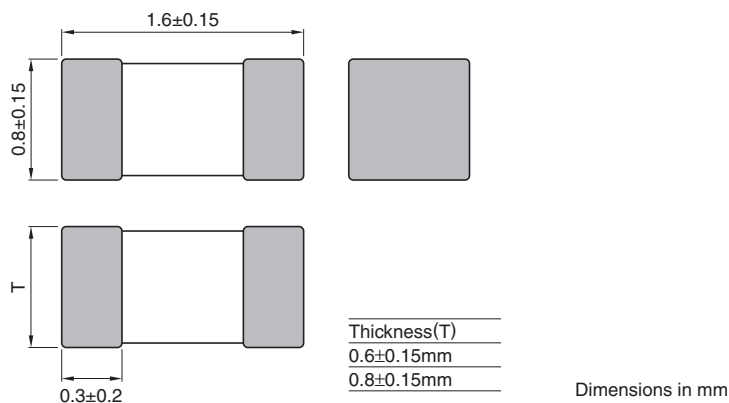

RECOMMENDED LAND PATTERN

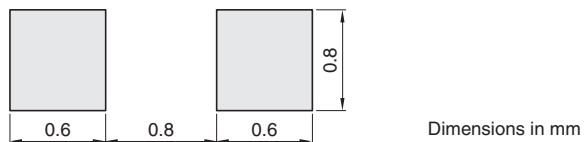

• All specifications are subject to change without notice.

MPZ series MPZ1608 Type

ELECTRICAL CHARACTERISTICS

CHARACTERISTICS SPECIFICATION TABLE

Impedance [100MHz] (Ω)	Tolerance	DC resistance (Ω)max.	Rated current* (A)max.	Thickness T (mm)	Part No.
470	$\pm 25\%$	0.150	1.0	0.8	MPZ1608B471AT□□□□
26	$\pm 25\%$	0.007	6.0	0.6	MPZ1608S260AT□□□□
30	$\pm 10\Omega$	0.010	5.0	0.6	MPZ1608S300AT□□□□
60	$\pm 25\%$	0.020	3.5	0.6	MPZ1608S600AT□□□□
100	$\pm 25\%$	0.030	3.0	0.6	MPZ1608S101AT□□□□
120	$\pm 25\%$	0.045	2.0	0.6	MPZ1608S121AT□□□□
180	$\pm 25\%$	0.050	2.0	0.6	MPZ1608S181AT□□□□
220	$\pm 25\%$	0.050	2.2	0.8	MPZ1608S221AT□□□□
330	$\pm 25\%$	0.080	1.7	0.8	MPZ1608S331AT□□□□
470	$\pm 25\%$	0.150	1.0	0.8	MPZ1608S471AT□□□□
600	$\pm 25\%$	0.150	1.0	0.8	MPZ1608S601AT□□□□
1000	$\pm 25\%$	0.300	0.8	0.8	MPZ1608S102AT□□□□
390	$\pm 25\%$	0.120	1.2	0.8	MPZ1608R391AT□□□□
60	$\pm 25\%$	0.030	2.3	0.8	MPZ1608Y600BT□□□□
100	$\pm 25\%$	0.040	2.0	0.8	MPZ1608Y101BT□□□□
150	$\pm 25\%$	0.050	1.8	0.8	MPZ1608Y151BT□□□□
220	$\pm 25\%$	0.100	1.5	0.8	MPZ1608Y221BT□□□□
30	$\pm 10\Omega$	0.060	1.8	0.8	MPZ1608D300BT□□□□
60	$\pm 25\%$	0.100	1.2	0.8	MPZ1608D600BT□□□□
100	$\pm 25\%$	0.150	1.0	0.8	MPZ1608D101BT□□□□

* Please refer to the graph of RATED CURRENT vs. TEMPERATURE CHARACTERISTICS (derating) about the rating current at 85°C or more in temperature of the product.

Measurement equipment

Measurement item	Product No.	Manufacturer
Impedance	E4991A+16192A	Agilent Technologies
DC resistance	Type-7556	Yokogawa

* Equivalent measurement equipment may be used.

Rated current vs. temperature characteristics (derating)

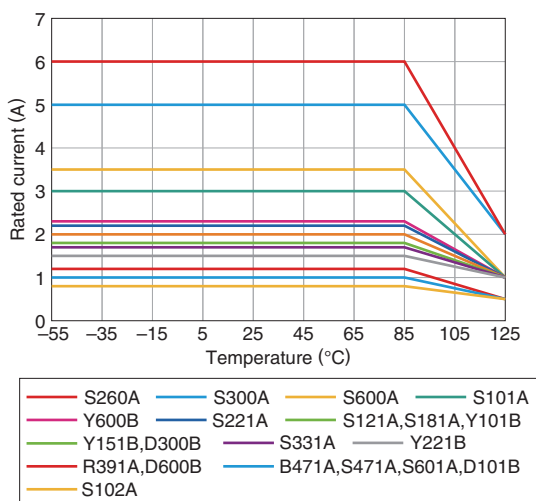

MPZ series MPZ1608 Type

ELECTRICAL CHARACTERISTICS

Z VS. FREQUENCY CHARACTERISTICS (BY SERIES)

MPZ1608B SERIES

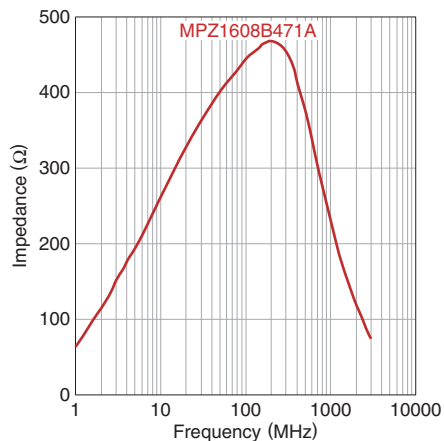

MPZ1608S SERIES

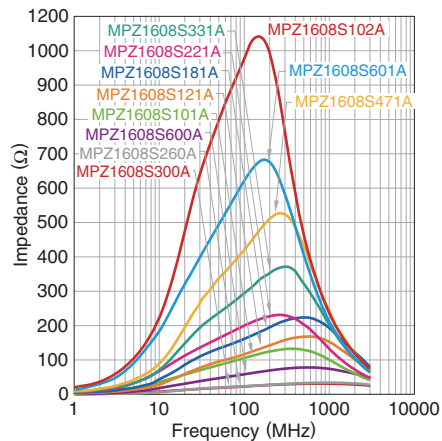

MPZ1608R SERIES

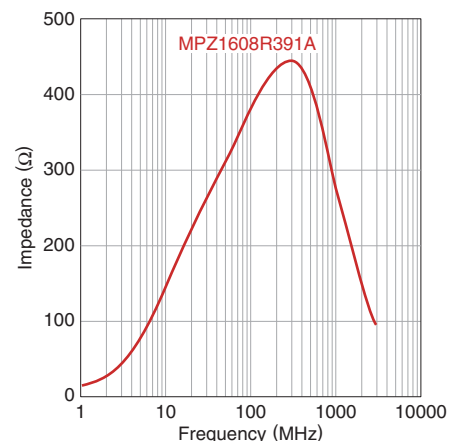

MPZ1608Y SERIES

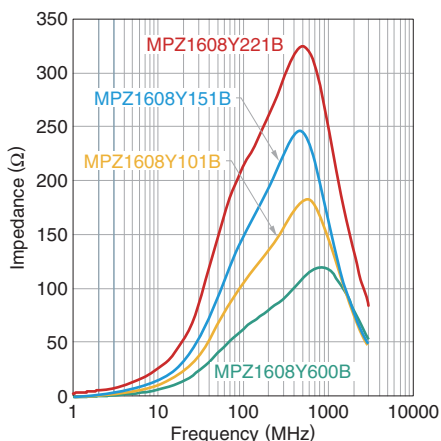

MPZ1608D SERIES

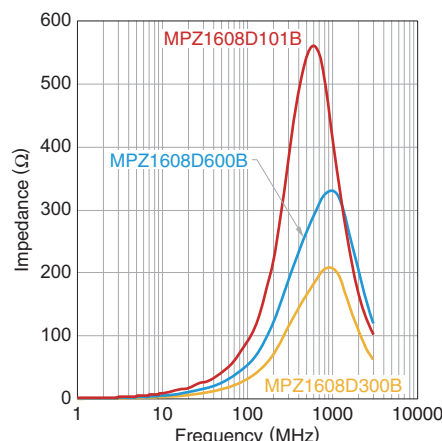

• All specifications are subject to change without notice.

MPZ series MPZ1608 Type

ELECTRICAL CHARACTERISTICS

Z, X, R VS. FREQUENCY CHARACTERISTICS

MPZ1608B471A

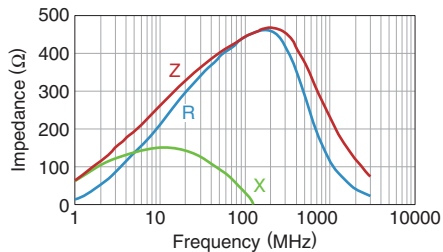

MPZ1608S260A

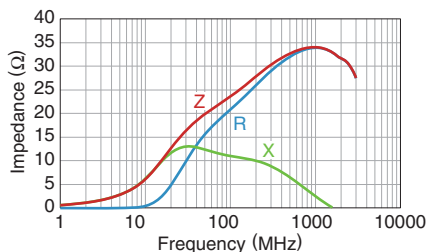

MPZ1608S300A

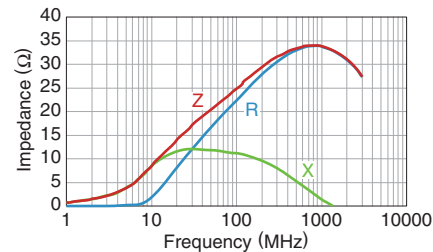

MPZ1608S600A

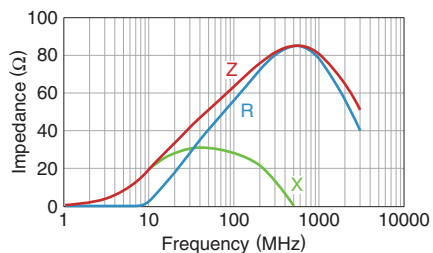

MPZ1608S101A

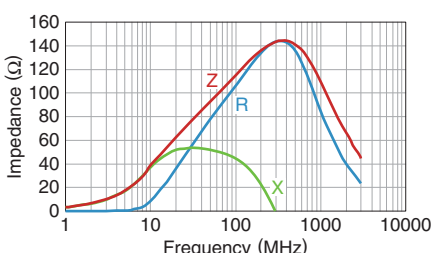

MPZ1608S121A

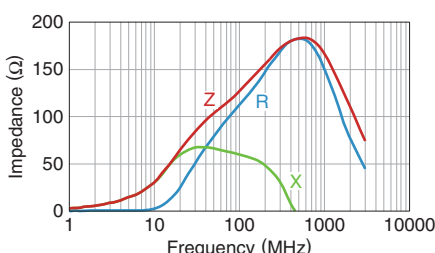

MPZ1608S181A

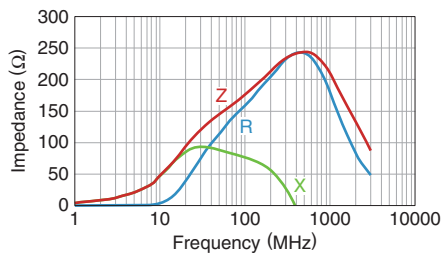

MPZ1608S221A

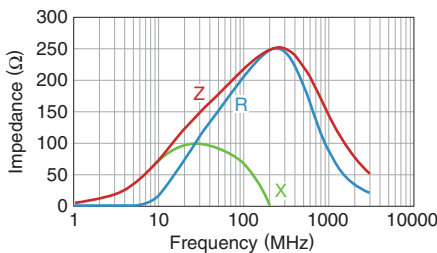

MPZ1608S331A

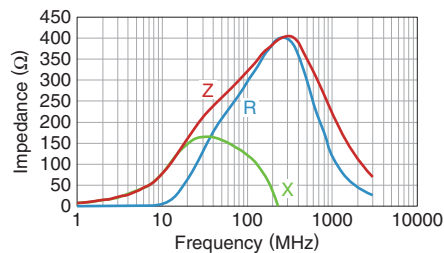

MPZ1608S471A

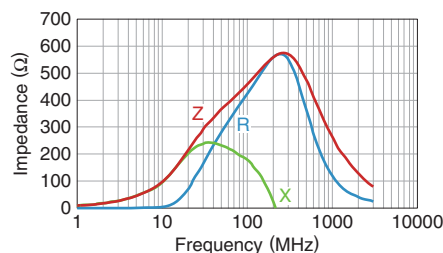

MPZ1608S601A

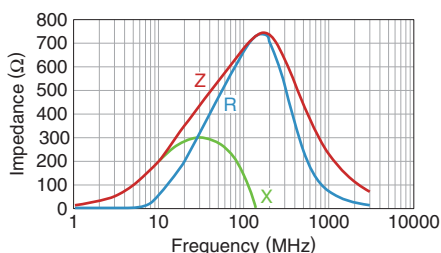

MPZ1608S102A

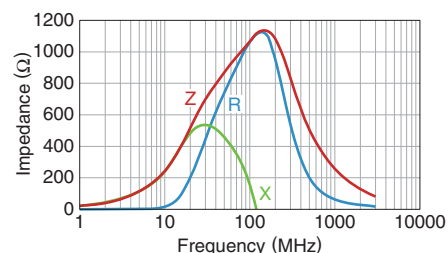

MPZ1608R391A

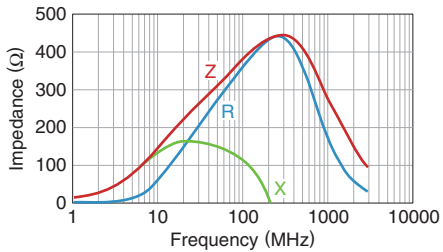

MPZ1608Y600B

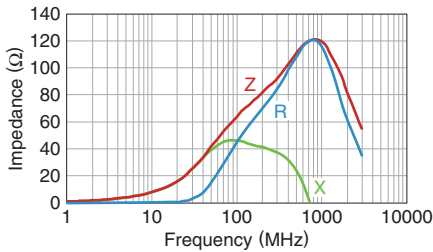

MPZ1608Y101B

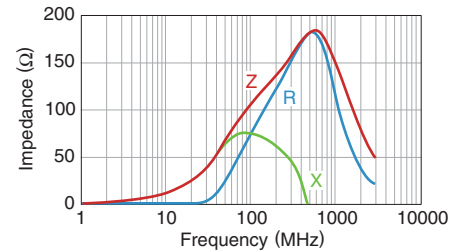

• All specifications are subject to change without notice.

MPZ series MPZ1608 Type

ELECTRICAL CHARACTERISTICS

Z, X, R VS. FREQUENCY CHARACTERISTICS

MPZ1608Y151B

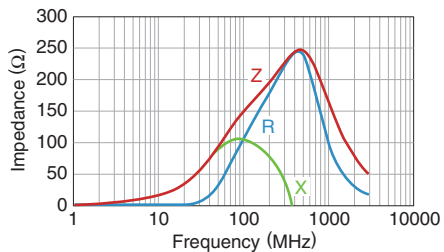

MPZ1608Y221B

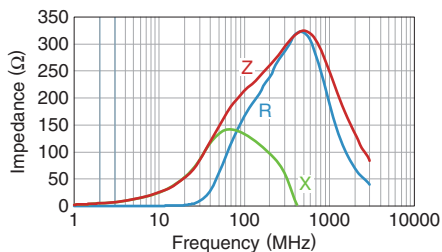

MPZ1608D300B

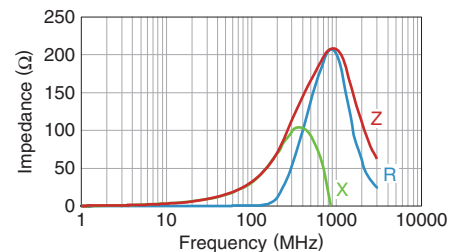

MPZ1608D600B

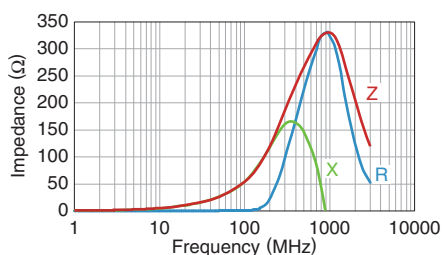

MPZ1608D101B

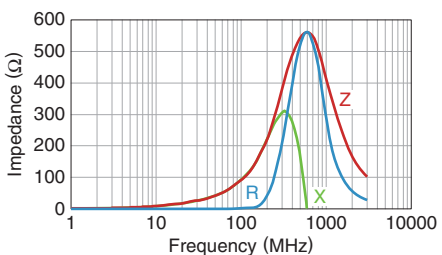

• All specifications are subject to change without notice.

MPZ series

MPZ2012 Type



SHAPE & DIMENSIONS

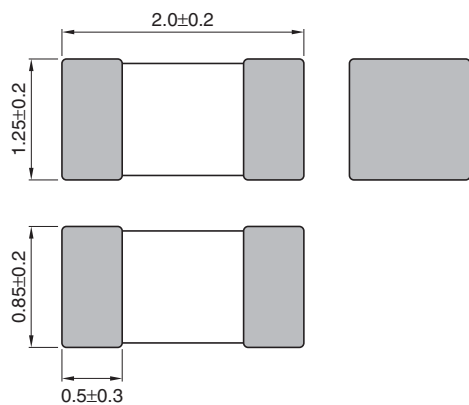

Dimensions in mm

RECOMMENDED LAND PATTERN

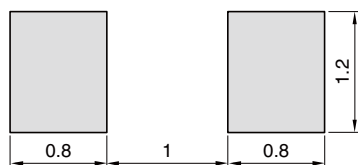

Dimensions in mm

• All specifications are subject to change without notice.

MPZ series MPZ2012 Type

ELECTRICAL CHARACTERISTICS

CHARACTERISTICS SPECIFICATION TABLE

Impedance [100MHz] (Ω)	Tolerance	DC resistance (Ω)max.	Rated current* (A)max.	Part No.
30	$\pm 10\Omega$	0.010	6	MPZ2012S300AT □□□
100	$\pm 25\%$	0.020	4	MPZ2012S101AT □□□
220	$\pm 25\%$	0.040	3	MPZ2012S221AT □□□
330	$\pm 25\%$	0.050	2.5	MPZ2012S331AT □□□
600	$\pm 25\%$	0.100	2	MPZ2012S601AT □□□
1000	$\pm 25\%$	0.150	1.5	MPZ2012S102AT □□□

* Please refer to the graph of RATED CURRENT vs. TEMPERATURE CHARACTERISTICS (derating) about the rating current at 85°C or more in temperature of the product.

Measurement equipment

Measurement item	Product No.	Manufacturer
Impedance	E4991A+16192A	Agilent Technologies
DC resistance	Type-7556	Yokogawa

* Equivalent measurement equipment may be used.

Rated current vs. temperature characteristics (derating)

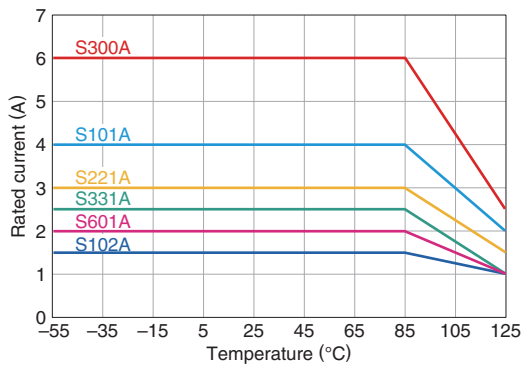

MPZ series MPZ2012 Type

■ ELECTRICAL CHARACTERISTICS

□ Z VS. FREQUENCY CHARACTERISTICS (BY SERIES)

MPZ2012S SERIES



• All specifications are subject to change without notice.

MPZ series MPZ2012 Type

ELECTRICAL CHARACTERISTICS

Z, X, R VS. FREQUENCY CHARACTERISTICS

MPZ2012S300A



MPZ2012S101A

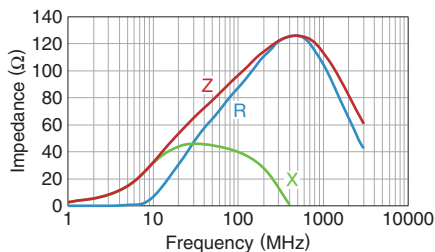

MPZ2012S221A



MPZ2012S331A



MPZ2012S601A

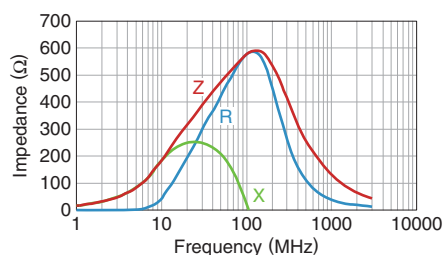

MPZ2012S102A



• All specifications are subject to change without notice.

MPZ series

Packaging style

REEL DIMENSIONS

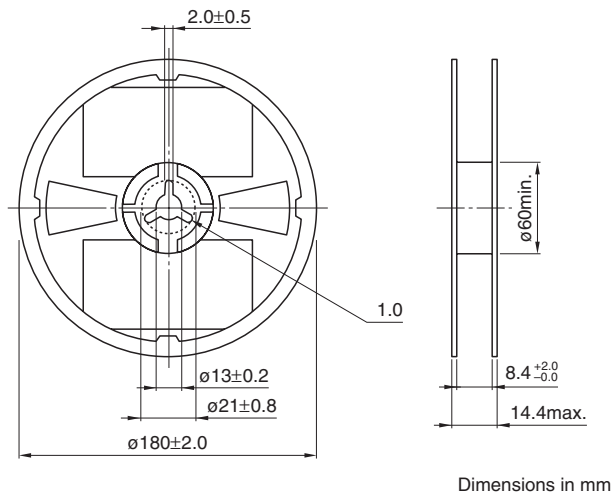

Dimensions in mm

TAPE DIMENSIONS

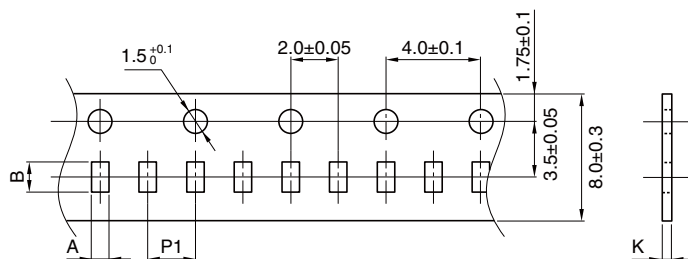

Dimensions in mm

Type	A	B	P1	K
MPZ0603	0.38±0.05	0.68±0.05	2.0±0.05	0.5max.
MPZ1005	0.65±0.1	1.15±0.1	2.0±0.05	0.8max.
MPZ1608	1.1±0.2	1.9±0.2	4.0±0.1	1.1max.
MPZ2012	1.5±0.2	2.3±0.2	4.0±0.1	1.1max.

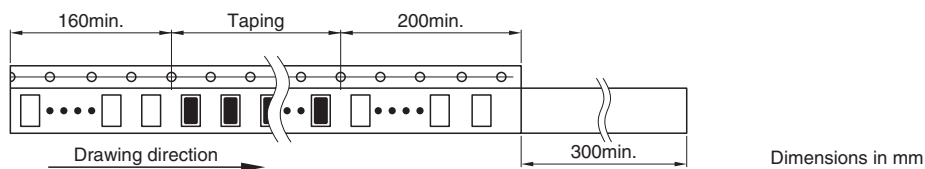

Dimensions in mm

• All specifications are subject to change without notice.



Компания «ЭлектроПласт» предлагает заключение долгосрочных отношений при поставках импортных электронных компонентов на взаимовыгодных условиях!

Наши преимущества:

- Оперативные поставки широкого спектра электронных компонентов отечественного и импортного производства напрямую от производителей и с крупнейших мировых складов;
- Поставка более 17-ти миллионов наименований электронных компонентов;
- Поставка сложных, дефицитных, либо снятых с производства позиций;
- Оперативные сроки поставки под заказ (от 5 рабочих дней);
- Экспресс доставка в любую точку России;
- Техническая поддержка проекта, помощь в подборе аналогов, поставка прототипов;
- Система менеджмента качества сертифицирована по Международному стандарту ISO 9001;
- Лицензия ФСБ на осуществление работ с использованием сведений, составляющих государственную тайну;
- Поставка специализированных компонентов (Xilinx, Altera, Analog Devices, Intersil, Interpoint, Microsemi, Aeroflex, Peregrine, Syfer, Eurofarad, Texas Instrument, Miteq, Cobham, E2V, MA-COM, Hittite, Mini-Circuits, General Dynamics и др.);

Помимо этого, одним из направлений компании «ЭлектроПласт» является направление «Источники питания». Мы предлагаем Вам помощь Конструкторского отдела:

- Подбор оптимального решения, техническое обоснование при выборе компонента;
- Подбор аналогов;
- Консультации по применению компонента;
- Поставка образцов и прототипов;
- Техническая поддержка проекта;
- Защита от снятия компонента с производства.



Как с нами связаться

Телефон: 8 (812) 309 58 32 (многоканальный)

Факс: 8 (812) 320-02-42

Электронная почта: org@eplast1.ru

Адрес: 198099, г. Санкт-Петербург, ул. Калинина, дом 2, корпус 4, литера А.